

OA2547 Series - All Metal

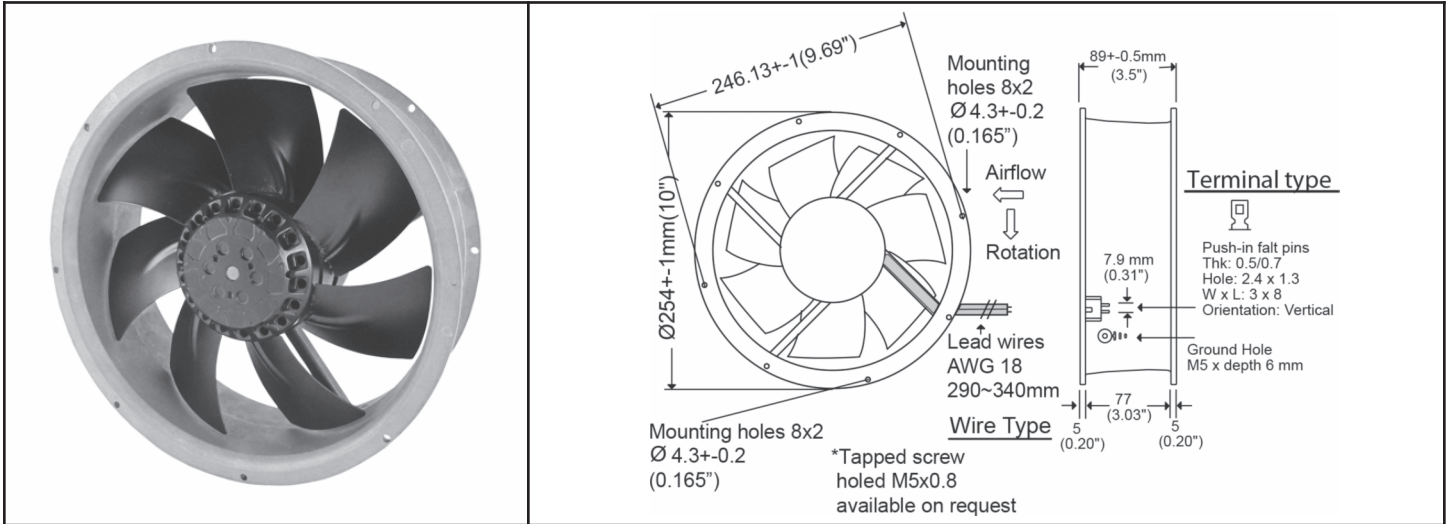

AC Fan - 115V, 230V
254 x 89mm (10.0" x 3.5")



Frame	Diecast Aluminum	Operating Temperature Ball Bearing -30C ~ +80C (non-condensing) Storage Temp -40C ~ +100C	
Impeller	Metal Alloy		
Connection	2x Lead Wires 18 AWG or terminals	Life Expectancy Ball Bearing 50,000 hours (L10 at 55C) Environmental Protection IP56	
Motor	AC Capacitor Induction, thermally protected	Weight: ~ 5.9 lbs	
Bearing System	Dual ball bearing	m0	
Insulation Resistance	>100M ohm between lead-wire and frame (500VDC)		
Dielectric Strength	1 min at 1500 VAC, 50/60Hz		

Model Number	Speed (RPM)	Airflow (CFM)	Noise (dB)	Volts AC	Voltage Range	Watts	Max. Static Pressure ("H ₂ O)	Curves
OA2547AN-11-1 * 1856	2800 3250	840 1000	70	115	100~120	95 105	0.78 0.60	2 (50Hz) 1 (60Hz)
OA2547AN-11-2 * 1856	2300 2200	660 620	63	115	100~120	80 95	0.33 0.27	4 (50Hz) 3 (60Hz)
OA2547AN-11-3 * 1856	1450 1700	485 570	46	115	100~120	32 40	0.25 0.20	6 (50Hz) 5 (60Hz)
OA2547AN-22-1 * 1856	2800 3250	840 1000	70	230	200~240	95 105	0.78 0.60	2 (50Hz) 1 (60Hz)
OA2547AN-22-2 * 1856	2300 2200	660 620	63	230	200~240	80 95	0.33 0.27	4 (50Hz) 3 (60Hz)
OA2547AN-22-3 * 1856	1450 1700	485 570	46	230	200~240	32 40	0.25 0.20	6 (50Hz) 5 (60Hz)

* Indicate "TB" for terminal type or "WB" for lead wires