



# UM10574

PCA9685 demonstration board OM13332

Rev. 1 — 1 April 2014

User manual

## Document information

Info	Content
<b>Keywords</b>	Fm+ I2C-bus, PCA9685, RGB and White LEDs, 16 channel x 12-bit PWMs
<b>Abstract</b>	The OM13332 is an add-on to 9-pin connector of the NXP I2C demo board 2005-1 or Fm+ I2C Bus development board. This daughter board makes it easy to test and design with the PCA9685, the LED output driver is programmed to be either open-drain with a 25 mA current sink capability at 5 V or totem pole with a 25 mA sink. The PCA9685 operates with a supply voltage range of 2.3 V to 5.5 V and the inputs and outputs are 5.5 V tolerant. This demo board, along with the Win-I2CUSB Lite GUI (PC based), provides an easy to use evaluation platform.



**Revision history**

Rev	Date	Description
1.0	20140401	user manual; initial release

**Contact information**

For more information, please visit: <http://www.nxp.com>

For sales office addresses, please send an email to: [salesaddresses@nxp.com](mailto:salesaddresses@nxp.com)

## 1. Introduction

---

The PCA9685 evaluation board features LEDs for color backlighting and Ambilight demonstrations. A graphical interface allows the user to explore the different functions of the driver easily. The board can be connected in series with other I<sup>2</sup>C demo-boards to create an evaluation system.

The IC communicates to the host via the industry standard I<sup>2</sup>C-bus/SMBus port. The evaluation software runs under Microsoft Windows PC platform.

## 2. Features

---

- A complete evaluation platform for the PCA9685 16-channel, 12-bit PWM Fm+ I<sup>2</sup>C-bus 25 mA voltage switch LED driver
- Easy to use GUI-based software demonstrates the capabilities of the PCA9685
- On-board RGB and White LEDs for visual experience
- Convenient test points for easy scope measurements and signal access
- USB interface to the host PC
- No external power supply required

## 3. Getting started

---

### 3.1 Assumptions

Familiarity with the I<sup>2</sup>C-bus is helpful but not required.

### 3.2 Static handling requirements

#### CAUTION



This device is sensitive to ElectroStatic Discharge (ESD). Therefore care should be taken during transport and handling. You must use a ground strap or touch the PC case or other grounded source before unpacking or handling the hardware.

### 3.3 Minimum system requirements

- PC Pentium 60 processor (or equivalent), 8 MB RAM, 10 MB of hard drive space
- One USB port (either 2.0 or 1.1 compatible)
- Windows 98SE, ME, 2000, XP, or Vista
- I<sup>2</sup>C demonstration board 2005-1 (OM6275) or WIN-I<sup>2</sup>CUSB board (from [www.demoboard.com](http://www.demoboard.com)).

### 3.4 Power requirements

The NXP demonstration board I<sup>2</sup>C 2005-1 and OM13332 hardware obtain power from the PC USB port. Take care not to exceed the USB port current capabilities.

## 4. Installation

### 4.1 I2C demo board 2005-1 and WIN-I2CUSB Lite software

The OM13332 is a daughter card to the OM6275 I2C demo board 2005-1. You can download the WIN-I2CUSB Lite Software, the OM6275 user manual UM10206, and find ordering information at the NXP web site [www.nxp.com/demoboard/OM6275.html](http://www.nxp.com/demoboard/OM6275.html).

The Win-I2CUSB Lite software from The Boardshop runs on Windows 98SE, ME, 2000, and XP, and is compatible with any PC hardware having a minimum of a Pentium processor and a USB port. The software allows the user to select one of the I<sup>2</sup>C-bus devices on the board from a menu and also provides a Universal mode (I2C Expert mode) to allow users to create their own I<sup>2</sup>C-bus commands with the same I<sup>2</sup>C-bus devices.

### 4.2 OM13332 connection to I2C demo board 2005-1

The I2C demo board 2005-1 should be disconnected from your PC before mounting the OM13332 board on to it. The OM13332 board has a 9-pin female connector (J2) that connects to the JP1 male connector on the I2C demo board 2005-1 as shown in [Figure 1](#).

With both boards facing you, with USB connector on the left-hand side as shown in [Figure 1](#), connect the OM13332 board to the I2C demo board 2005-1 before connecting the USB cable. Once the board is connected, connect the USB cable and start the WIN-I2CUSB Lite software. You are now ready to evaluate the PCA9685.

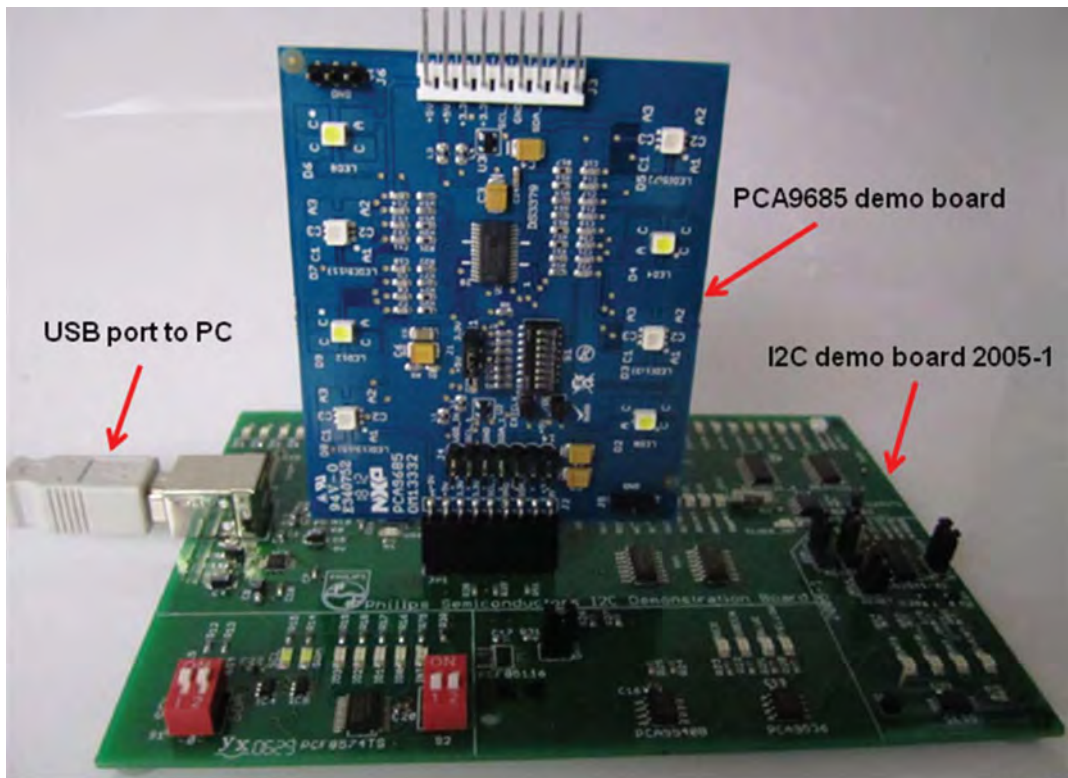

019aac799

Fig 1. PCA9685 demo board (OM13332) mounting to the I2C demo board 2005-1 (OM6275)

### 4.3 OM13332 connection to Win-I2CUSB hardware adapter board

The Win-I2CUSB board should be disconnected from your PC before connecting the OM13332 board on to it. The OM13332 board has a 14-pin male connector (J4) that connects to the 14-pin male connector (J1) on the Win-I2CUSB board as shown in [Figure 2](#).

Connect the OM13332 board to the Win-I2CUSB board before connecting the USB cable. Once the board is connected, connect the USB cable and start the WIN-I2CUSB Lite software. You are now ready to evaluate the PCA9685.

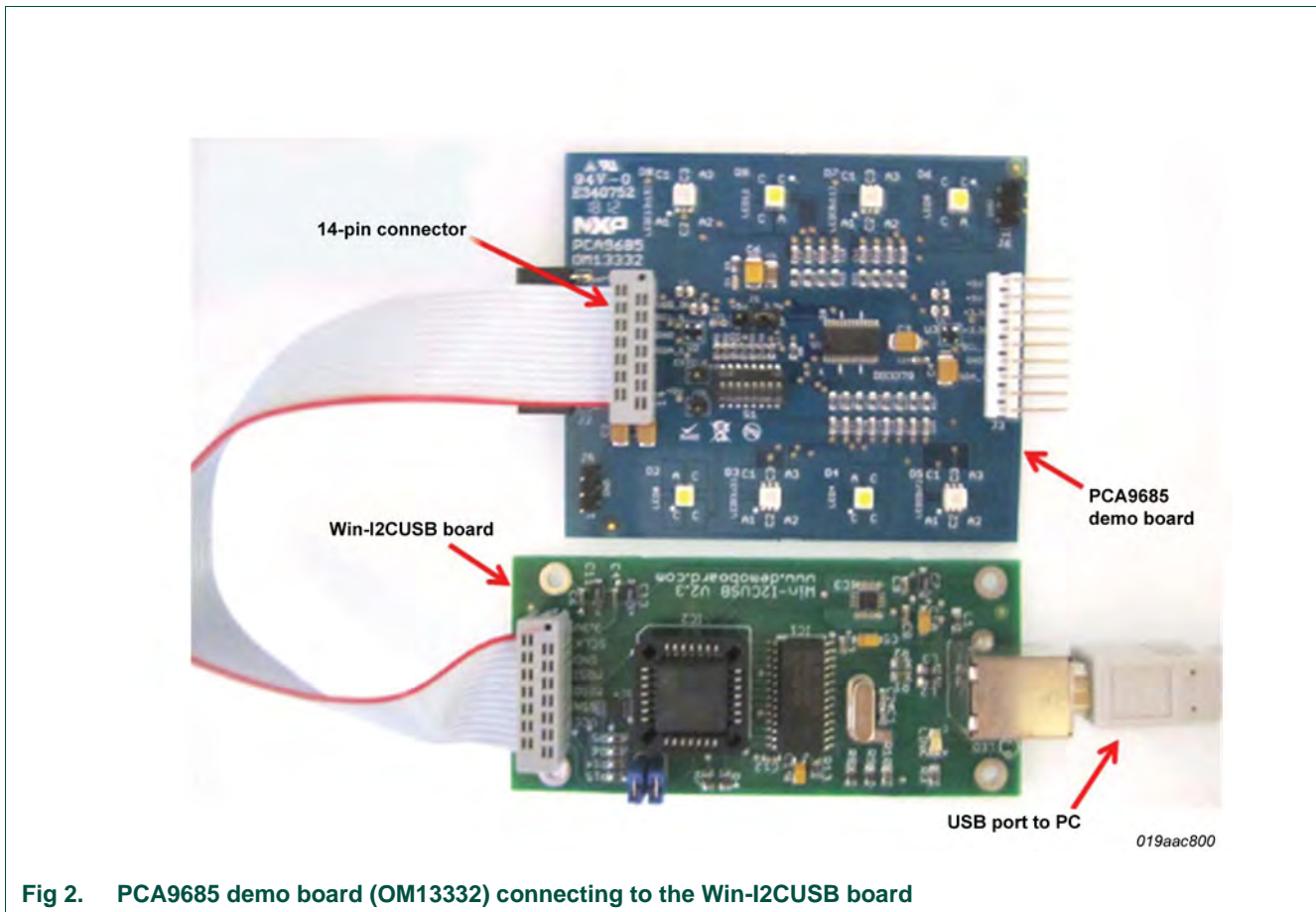

Fig 2. PCA9685 demo board (OM13332) connecting to the Win-I2CUSB board

## 5. Hardware description

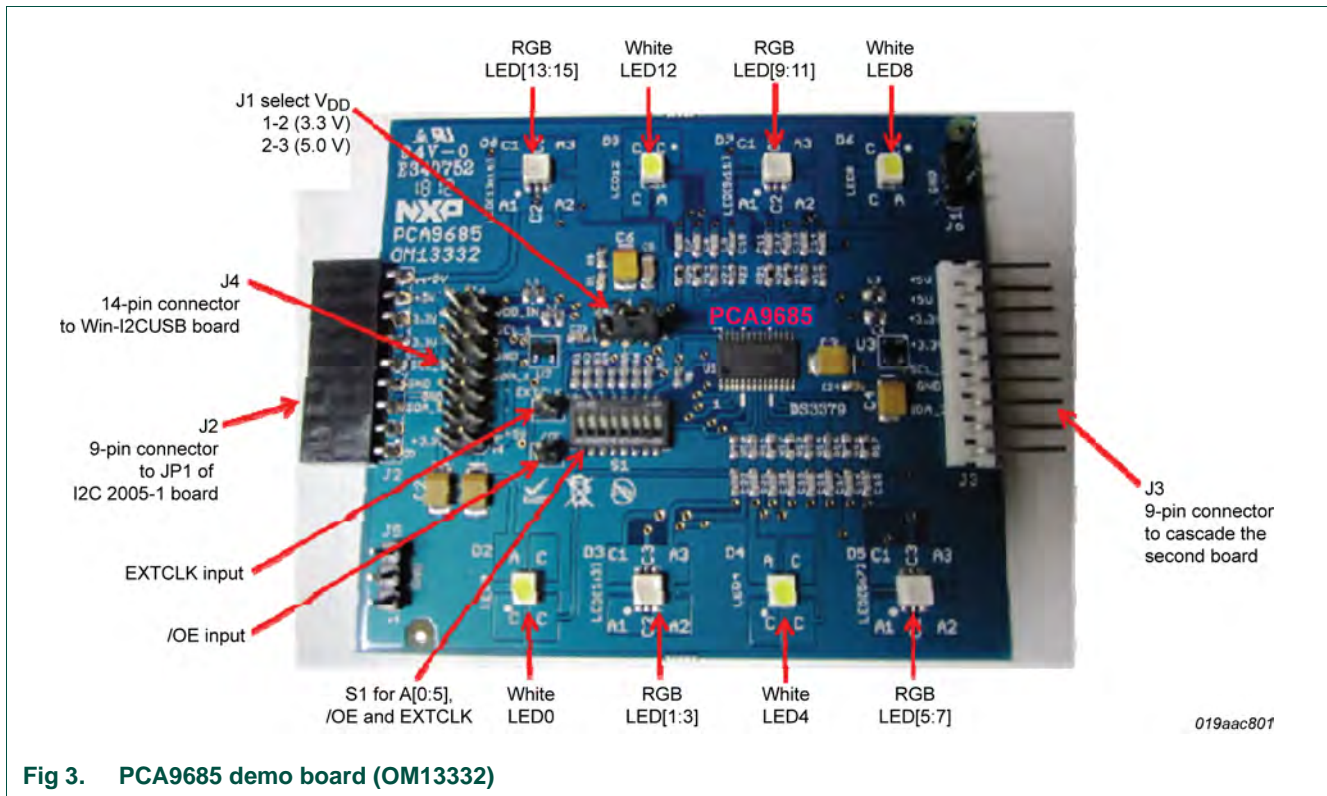

Fig 3. PCA9685 demo board (OM13332)

Figure 3 shows the following items on the hardware:

- J2 (9-pin) is for connection to JP1 on I2C demo board 2005-1.
- J3 (9-pin male) is for connection to the second PCA9685 demo board or I<sup>2</sup>C-bus device.
- J1 selects V<sub>DD</sub> power for PCA9685, connected 1-2 for V<sub>DD</sub> = 3.3 V and connected 2-3 for V<sub>DD</sub> = 5 V.
- S1 8-position DIP switch to select I<sup>2</sup>C-bus address A[0:5] = S1[1:6] for this device (default is 0x80, all switches S1[1:6] are ON position). S1[7] is used to control output enable (/OE, default is ON position to enable LED outputs), S1[8] is used to control EXTCLK (default is ON position to disable the EXTCLK).
- J4 (14-pin) is for connection to J1 on Win-I2CUSB board.
- 4-channel to drive four White LEDs (D2, D4, D6, D9) and 12-channel to drive four RGB LEDs (D3, D5, D7, D8).
- /OE (TP1) is input to drive output enable (pin 23) when S1[7] is set to OFF position.
- EXTCLK (TP2) is input to EXTCLK (pin 25) when S1[8] is set to OFF position.
- J5 and J6 are GND pins for probing use.



## 6. Schematic

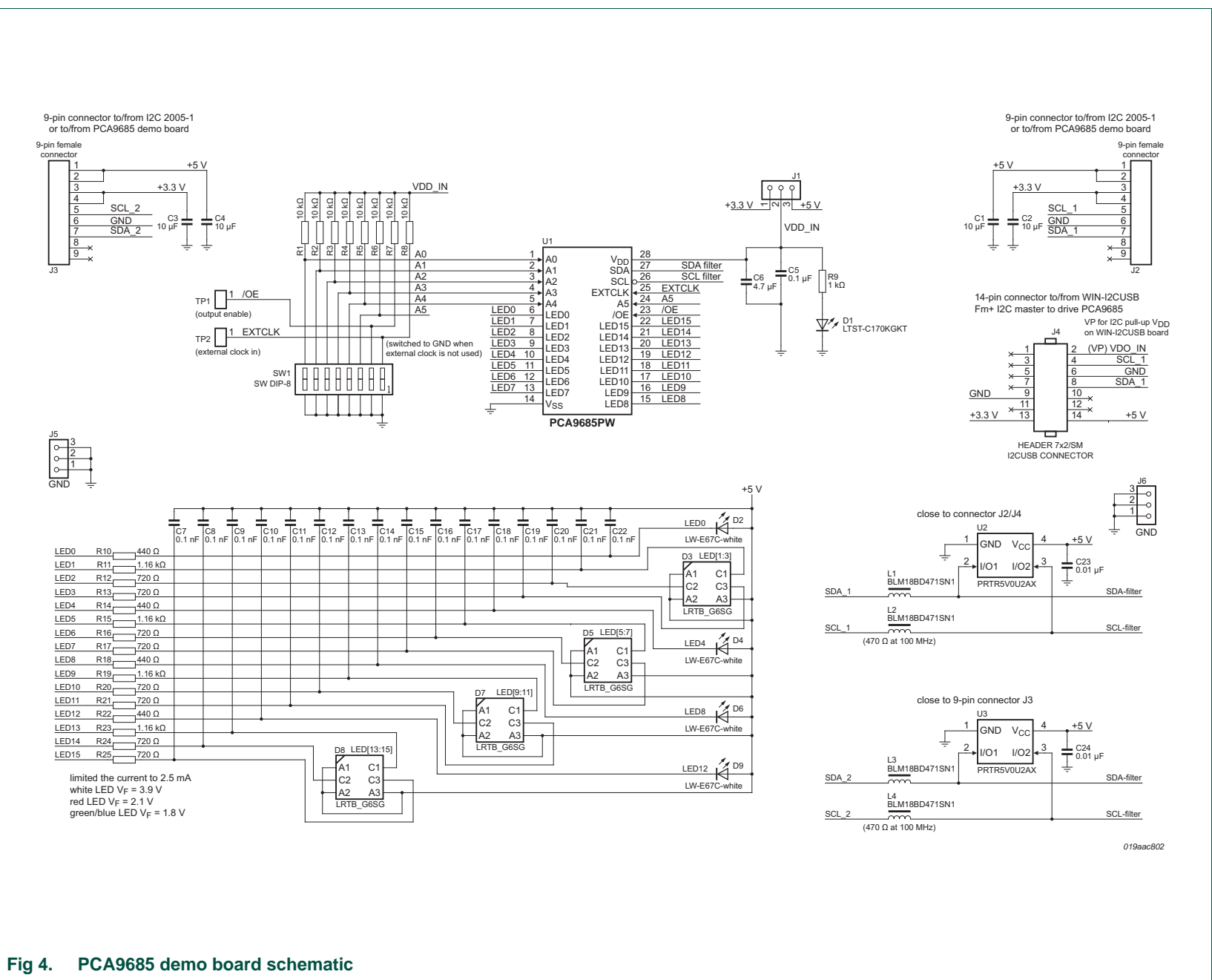

Fig 4. PCA9685 demo board schematic

## 7. OM13332 demonstration board main components

Table 1. OM13332 demo board main components

Device	Description	Address/LED output	Location
PCA9685PW	16-channel, 12-bit PWM Fm+ I <sup>2</sup> C-bus 25 mA voltage switch LED driver	0x80 for I2C demo board 2005-1 interface	U1
LW-E67C	White LED	LED0, LED4, LED8, LED12	D2, D4, D6, D9
LRTB_G6SG	RGB LED	LED1, LED2, LED3	D3
LRTB_G6SG	RGB LED	LED5, LED6, LED7	D5
LRTB_G6SG	RGB LED	LED9, LED10, LED11	D7
LRTB_G6SG	RGB LED	LED13, LED14, LED15	D8
LTST-C170KGKT	Green LED for PCA9685 power supply either 3.3 V or 5 V indicator	-	D1

## 8. PCA9685 evaluation steps

The PCA9685 functions are controlled by WIN-I2CUSB Lite GUI. Refer to the PCA9685 data sheet for additional information on the registers and functionality.

Connect the hardware as described in [Section 4](#). The PCA9685 demo board address is set to 0x80 on DIP switch (S1) as A[0:5] = S1[1:6] = 000000 (0 → ON, 1 → OFF). When you have correctly installed the software and the demonstration board hardware is connected and recognized by the computer, start the Win-I2CUSB Lite software. As shown in [Figure 5](#), when the demonstration board hardware is correctly connected to the USB port and the computer recognizes it, the message ‘Hardware Detected’ is displayed on the bottom of the window.

Switched 3.3 V and 5.0 V power supplies are controlled through the ‘Options’ menu or by double-clicking on the 3.3 V or 5.0 V symbols on the bottom of the window. Power supplies are disabled by default and you must enable them before using the I<sup>2</sup>C-bus devices on the board. I<sup>2</sup>C-bus frequency is controlled through the ‘Options’ menu or by double-clicking the frequency symbol on the bottom of the window.

### 8.1 Dimming and brightness control for individual LED

The PCA9685 has 4096 steps (12-bit PWM) of individual LED brightness control to vary from fully off (default) to maximum brightness. The LED output frequency (all LEDs) typically varies from 24 Hz to 1526 Hz (default of 1Eh in PRE\_SCALE register results in a 197 Hz refresh rate with oscillator clock of 25 MHz). The duty cycle of PWM can be controlled independently using the ‘LEDn ON’ and ‘LEDn OFF’ registers. The resolution for the phase shift is  $\frac{1}{4096}$  of the target frequency.

1. From the ‘Device’ drop-down menus, select ‘LED Blinkers and Dimmers’, and from the subsequent drop-down menu select ‘PCA9685 16-channel LED Driver with 12-bit PWM’ as shown in [Figure 5](#).
2. The device address is set to ‘80’ hexadecimal and cannot change. Check the ‘Auto Write On’ box (lower left), uncheck the ‘Low-power mode (oscillator off)’ box to enable the device to ‘Normal mode’ (upper left).



3. For LED output that directly connects to LED as the demo board design, the INVRT bit in MODE2 register must be set to 1 by checking the 'Output not inverted' to 'Output inverted' and the OUTDRV bit in MODE2 register must be set to 0 by checking the 'Totem pole outputs' to 'Open-drain outputs' to make sure all LEDs are completed OFF state as shown in [Figure 6](#).
4. The device configuration screen is displayed by clicking the following options:
  - 'PWM 0 to 3' individual brightness control for LED0 to LED3
  - 'PWM 4 to 7' individual brightness control for LED4 to LED7
  - 'PWM 8 to 11' individual brightness control for LED8 to LED11
  - 'PWM 12 to 15' individual brightness control for LED12 to LED15
  - 'Control Registers' all LED[0:15] brightness control and Prescale for all LEDs output frequency as shown in [Figure 7](#)
5. In [Figure 6](#), uncheck the 'LEDn Full Off' box (lower bottom), adjust both 'LEDn ON' and 'LEDn OFF' bar for dimming/brightness effect, also move LED1 ON/OFF to control red, LED2 ON/OFF to control green, LED3 ON/OFF to control blue for color mixing.

**Remark:** The LED ON time, which is programmable, is the time to assert the LED output and the LED OFF time, which is also programmable, is the time to negate the LED output.

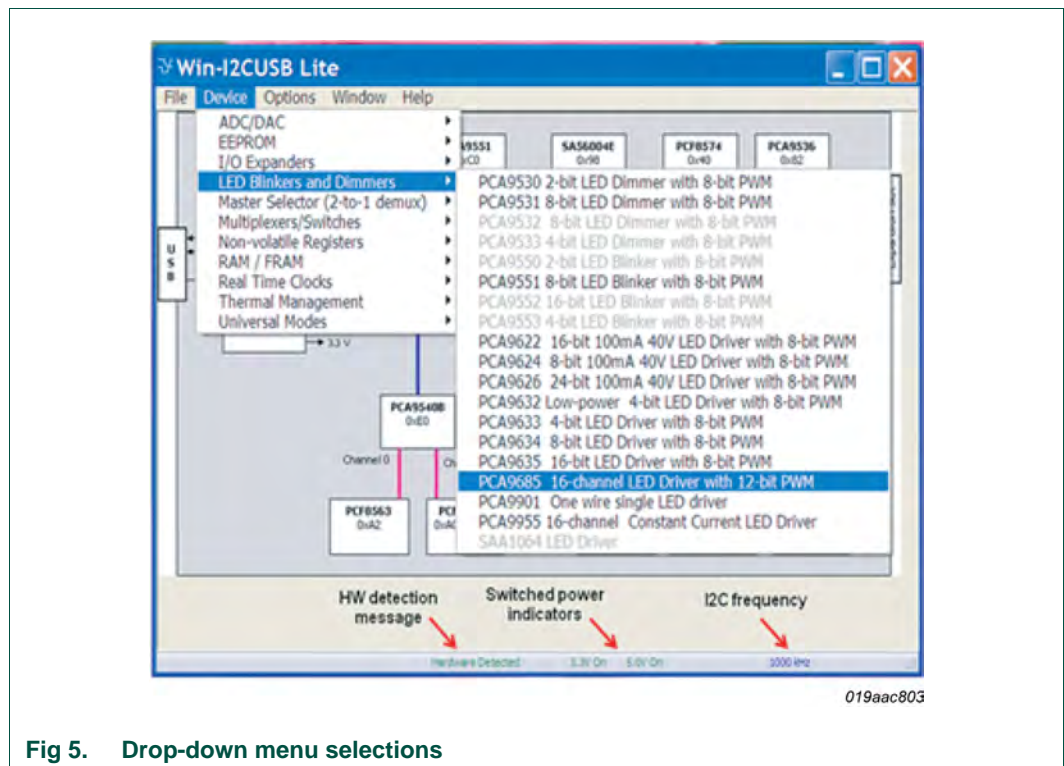

Fig 5. Drop-down menu selections

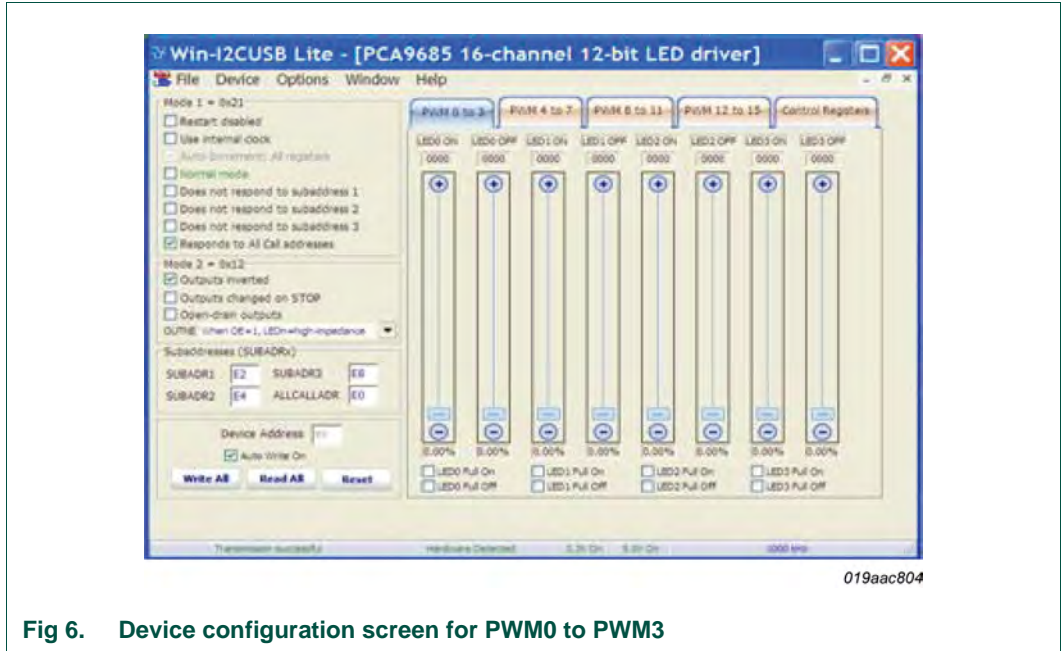

Fig 6. Device configuration screen for PWM0 to PWM3

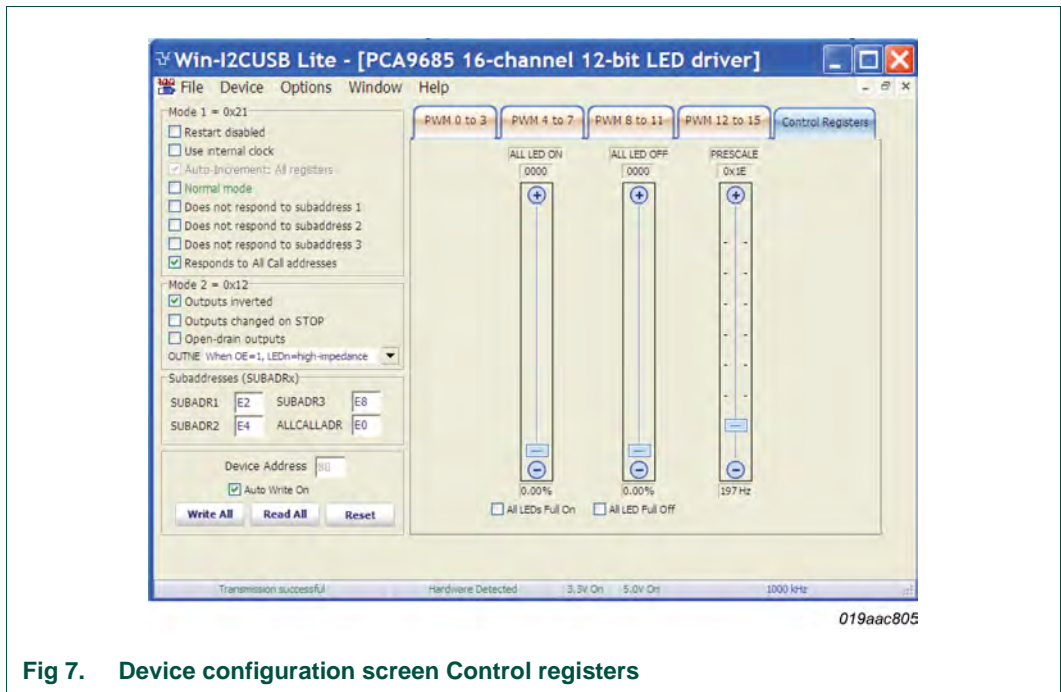

Fig 7. Device configuration screen Control registers

## 8.2 Dimming and brightness control for all LEDs and Prescale

The following steps to control dimming/brightness for all LEDs and adjust output frequency with prescale value:

1. Click the 'Control Registers' configuration screen for all LED[0:15] brightness control and Prescale for LEDs output frequency as shown in [Figure 7](#).
2. In [Figure 7](#), uncheck the 'All LED Full Off' box (lower bottom), adjust both 'All LED ON' and 'All LED OFF' bar for all LEDs dimming/brightness effect.
3. Adjust the 'PRESCALE' bar to program the LED output frequency (PWM) as shown below:
  - LED output frequency =  $(25 \text{ MHz or EXTCLK}) \div (4096 \times (\text{prescale} + 1))$
  - When Prescale = 0x1E (default is 30), the LED output frequency is  $(25 \times 10^6) \div (4096 \times 31) = 197 \text{ Hz}$
  - When Prescale = 0x03 (minimum is 3), the LED output frequency is  $(25 \times 10^6) \div (4096 \times 4) = 1526 \text{ Hz}$
  - When Prescale = 0xFF (maximum is 255), the LED output frequency is  $(25 \times 10^6) \div (4096 \times 256) = 24 \text{ Hz}$

**Remark: The PRESCALE register value can only be set/update when the SLEEP bit in the MODE1 register is set to logic 1** as shown in [Figure 8](#). Apply external clock input to EXTCLK pin, user must set the SLEEP bit in MODE1 register, then write logic 1 to both the SLEEP and EXTCLK bits in MODE1 register to enable the external clock.

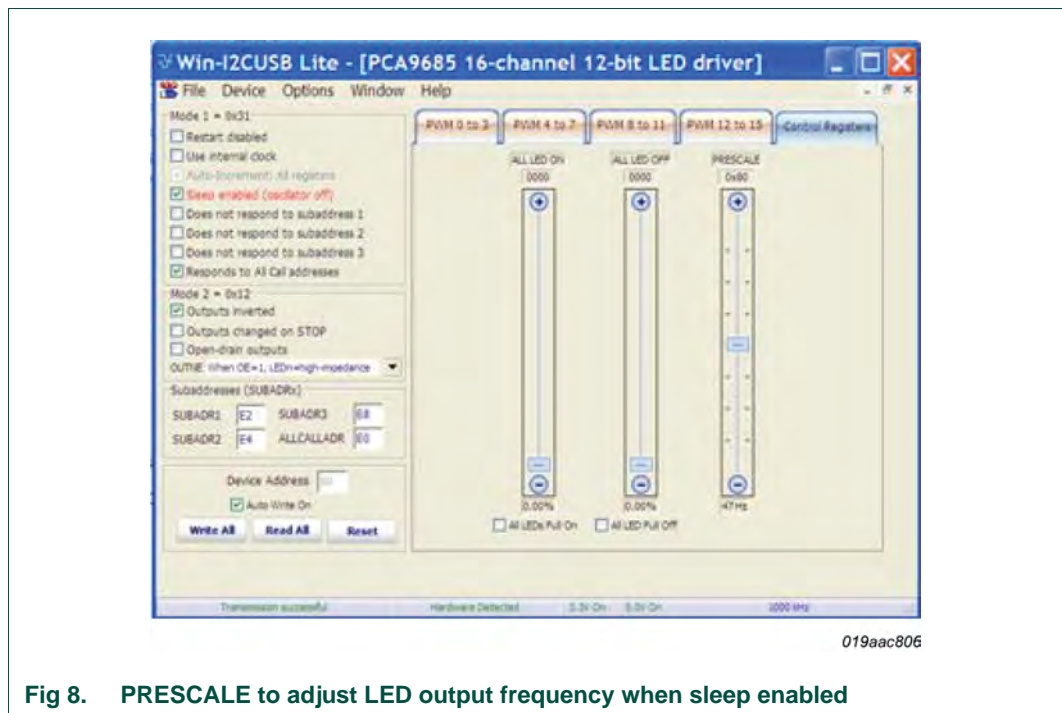

Fig 8. PRESCALE to adjust LED output frequency when sleep enabled

## 9. Support

---

For support, send an E-mail to: [i2c.support@nxp.com](mailto:i2c.support@nxp.com)

## 10. Abbreviations

---

**Table 2. Abbreviations**

Acronym	Description
ESD	ElectroStatic Discharge
GUI	Graphical User Interface
I <sup>2</sup> C-bus	Inter-Integrated Circuit bus
IC	Integrated Circuit
LED	Light-Emitting Diode
PC	Personal Computer
PWM	Pulse Width Modulator
RAM	Random Access Memory
RGB	Red/Green/Blue
RGBA	Red/Green/Blue/Amber
SMBus	System Management Bus
USB	Universal Serial Bus

## 11. References

---

- [1] **PCA9685, 16-channel, 12-bit PWM Fm+ I<sup>2</sup>C-bus 25 mA voltage switch LED driver** — Product data sheet; NXP Semiconductors; [www.nxp.com/documents/data\\_sheet/PCA9685.pdf](http://www.nxp.com/documents/data_sheet/PCA9685.pdf)
- [2] **UM10206, “I<sup>2</sup>C Demonstration Board 2005-1 Quick Start Guide”** — NXP Semiconductors; [www.nxp.com/documents/user\\_manual/UM10206.pdf](http://www.nxp.com/documents/user_manual/UM10206.pdf)

## 12. Legal information

### 12.1 Definitions

**Draft** — The document is a draft version only. The content is still under internal review and subject to formal approval, which may result in modifications or additions. NXP Semiconductors does not give any representations or warranties as to the accuracy or completeness of information included herein and shall have no liability for the consequences of use of such information.

### 12.2 Disclaimers

**Limited warranty and liability** — Information in this document is believed to be accurate and reliable. However, NXP Semiconductors does not give any representations or warranties, expressed or implied, as to the accuracy or completeness of such information and shall have no liability for the consequences of use of such information. NXP Semiconductors takes no responsibility for the content in this document if provided by an information source outside of NXP Semiconductors.

In no event shall NXP Semiconductors be liable for any indirect, incidental, punitive, special or consequential damages (including - without limitation - lost profits, lost savings, business interruption, costs related to the removal or replacement of any products or rework charges) whether or not such damages are based on tort (including negligence), warranty, breach of contract or any other legal theory.

Notwithstanding any damages that customer might incur for any reason whatsoever, NXP Semiconductors' aggregate and cumulative liability towards customer for the products described herein shall be limited in accordance with the *Terms and conditions of commercial sale* of NXP Semiconductors.

**Right to make changes** — NXP Semiconductors reserves the right to make changes to information published in this document, including without limitation specifications and product descriptions, at any time and without notice. This document supersedes and replaces all information supplied prior to the publication hereof.

**Suitability for use** — NXP Semiconductors products are not designed, authorized or warranted to be suitable for use in life support, life-critical or safety-critical systems or equipment, nor in applications where failure or malfunction of an NXP Semiconductors product can reasonably be expected to result in personal injury, death or severe property or environmental damage. NXP Semiconductors and its suppliers accept no liability for inclusion and/or use of NXP Semiconductors products in such equipment or applications and therefore such inclusion and/or use is at the customer's own risk.

**Applications** — Applications that are described herein for any of these products are for illustrative purposes only. NXP Semiconductors makes no representation or warranty that such applications will be suitable for the specified use without further testing or modification.

Customers are responsible for the design and operation of their applications and products using NXP Semiconductors products, and NXP Semiconductors accepts no liability for any assistance with applications or customer product

design. It is customer's sole responsibility to determine whether the NXP Semiconductors product is suitable and fit for the customer's applications and products planned, as well as for the planned application and use of customer's third party customer(s). Customers should provide appropriate design and operating safeguards to minimize the risks associated with their applications and products.

NXP Semiconductors does not accept any liability related to any default, damage, costs or problem which is based on any weakness or default in the customer's applications or products, or the application or use by customer's third party customer(s). Customer is responsible for doing all necessary testing for the customer's applications and products using NXP Semiconductors products in order to avoid a default of the applications and the products or of the application or use by customer's third party customer(s). NXP does not accept any liability in this respect.

**Export control** — This document as well as the item(s) described herein may be subject to export control regulations. Export might require a prior authorization from competent authorities.

**Evaluation products** — This product is provided on an "as is" and "with all faults" basis for evaluation purposes only. NXP Semiconductors, its affiliates and their suppliers expressly disclaim all warranties, whether express, implied or statutory, including but not limited to the implied warranties of non-infringement, merchantability and fitness for a particular purpose. The entire risk as to the quality, or arising out of the use or performance, of this product remains with customer.

In no event shall NXP Semiconductors, its affiliates or their suppliers be liable to customer for any special, indirect, consequential, punitive or incidental damages (including without limitation damages for loss of business, business interruption, loss of use, loss of data or information, and the like) arising out of the use of or inability to use the product, whether or not based on tort (including negligence), strict liability, breach of contract, breach of warranty or any other theory, even if advised of the possibility of such damages.

Notwithstanding any damages that customer might incur for any reason whatsoever (including without limitation, all damages referenced above and all direct or general damages), the entire liability of NXP Semiconductors, its affiliates and their suppliers and customer's exclusive remedy for all of the foregoing shall be limited to actual damages incurred by customer based on reasonable reliance up to the greater of the amount actually paid by customer for the product or five dollars (US\$5.00). The foregoing limitations, exclusions and disclaimers shall apply to the maximum extent permitted by applicable law, even if any remedy fails of its essential purpose.

**Translations** — A non-English (translated) version of a document is for reference only. The English version shall prevail in case of any discrepancy between the translated and English versions.

### 12.3 Trademarks

Notice: All referenced brands, product names, service names and trademarks are the property of their respective owners.

**PC-bus** — logo is a trademark of NXP Semiconductors N.V.