



Smart, simple solutions for the 12 most common design concerns

NXP I²C-bus solutions 2014



I²C-bus: The serial revolution

By replacing complex parallel interfaces with a straightforward yet powerful serial structure, the I²C-bus revolutionized chip-to-chip communications.

Invented by NXP (Philips) more than 30 years ago, the I²C-bus uses a simple two-wire format to carry data one bit at a time. It performs inter-chip addressing, selection, control, and data transfer. Speeds are up to 400 kHz (Fast-mode), 1 MHz (Fast-mode Plus), 3.4 MHz (High Speed-mode), or 5 MHz (Ultra Fast-mode).

The I²C-bus shrinks the IC footprint and leads to lower IC costs. Plus, since far fewer copper traces are needed, it enables a smaller PCB, reduces design complexity, and lowers system cost.

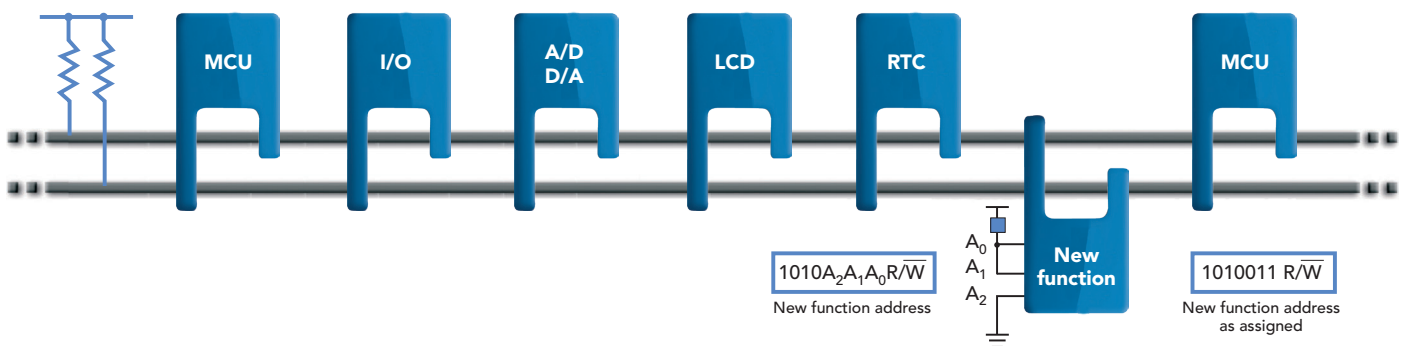
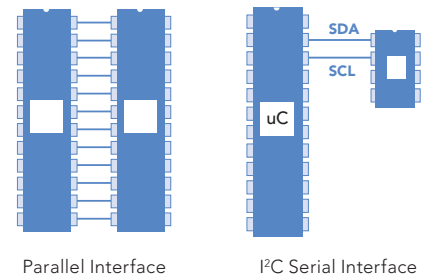

I²C-bus devices are available in a wide range of functions. Each slave device has its own I²C-bus address, selectable using address pins set high (1) or low (0). Information is transmitted byte by byte, and each byte is acknowledged by the receiver. There can be multiple devices on the same bus, and more than one IC can act as master. The master role is typically played by a microcontroller.

Write data

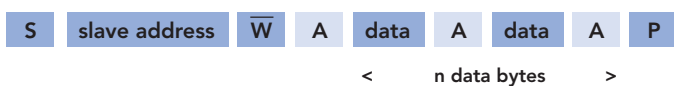

Read data

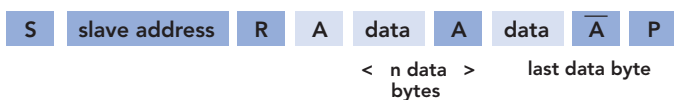

S = Start condition R/W̄ = read/write
 A = Acknowledge Ā = Not acknowledge P = Stop condition

Master



The master always sends the clock

NXP's I²C peripherals portfolio is grouped into twelve families, one for each of the most common, everyday design concerns.

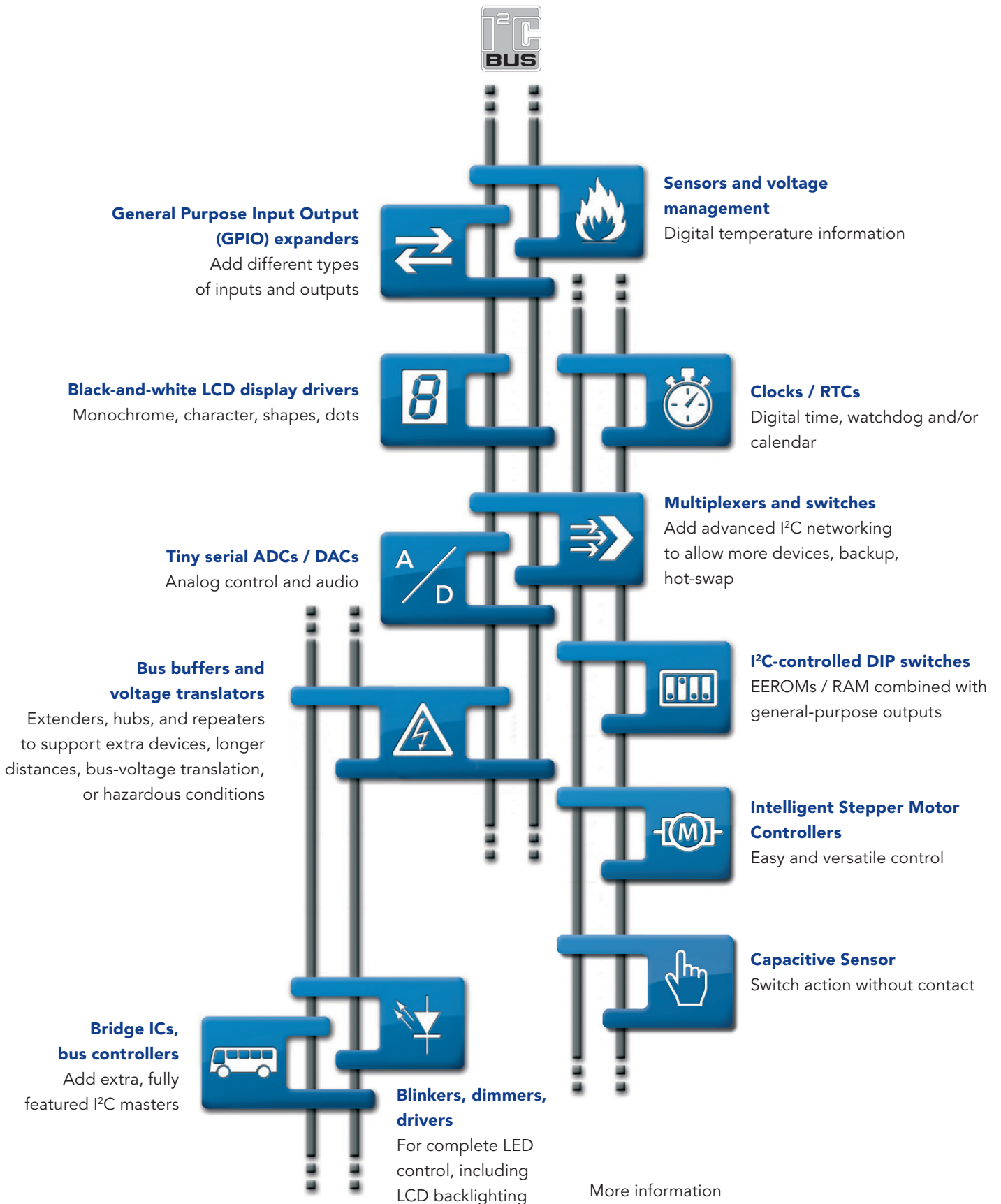

I²C-bus product summary

GPIO Expander		
4-bit	PCA9536	4-bit I ² C Fm TP GPIO with PU
	PCA9537	4-bit I ² C Fm TP GPIO with INT and RST
	PCA9570	4-bit 1 MHz LV TP GPO
8-bit	PCA8574	8-bit I ² C Sm QB GPIO with INT and PU
	PCF8574	8-bit I ² C Fm QB GPIO with INT and PU
	PCA8574A	8-bit I ² C Fm QB GPIO with INT and PU (Alternate address)
	PCF8574A	8-bit I ² C Sm QB GPIO with INT and PU (Alternate address)
	PCA9500	8-bit I ² C Fm QB GPIO with PU and 2-K EEPROM
	PCA9501	8-bit I ² C Fm QB GPIO with INT, PU and 2-K EEPROM
	PCA9502	8-bit I ² C Fm/SPI TP GPIO with INT and RST
	PCA9534	8-bit I ² C Fm TP GPIO with INT
	+ PCA9538	8-bit I ² C Fm TP GPIO with INT and RST
	PCA9538A	8-bit I ² C Fm LV TP GPIO with INT and RST
	PCAL9538A	8-bit I ² C Fm LV TP/OD GPIO with INT, RST, latch and PU/PD
	PCA6408A	8-bit I ² C Fm LV VLT TP GPIO with INT and RST
	PCAL6408A	8-bit I ² C Fm LV VLT TP/OD GPIO with INT, RST, latch and PU/PD
	PCA9554	8-bit I ² C Fm TP GPIO with INT and PU
	PCA9554A	8-bit I ² C Fm TP GPIO with INT and PU (alternate address for PCA9554)
	PCA9554B	8-bit I ² C Fm LV TP GPIO with INT and PU
	PCAL9554B	8-bit I ² C Fm LV TP/OD GPIO with INT, latch and PU/PD (PU default)
	PCA9554C	8-bit I ² C Fm LV TP GPIO with INT and PU (alternate address for PCA9554B)
	PCAL9554C	8-bit I ² C Fm LV TP/OD GPIO with INT, latch and PU/PD (PU default) (alternate address for PCAL9554B)
	PCA9557	8-bit I ² C Fm TP GPIO with RST
	PCA9571	8-bit 1 MHz LV TP GPO
	PCA9574	8-bit I ² C Fm LV VLT TP/OD GPIO with INT, RST, latch and PU/PD
	PCA9621	8-bit I ² C Fm+ 65 mA OD GPO with RST
	PCA9670	8-bit I ² C Fm+ QB GPIO with RST and PU
	PCA9672	8-bit I ² C Fm+ QB GPIO with INT, RST and PU
	PCA9674	8-bit I ² C Fm+ QB GPIO with INT and PU
	PCA9674A	8-bit I ² C Fm+ QB GPIO with INT and PU (Alternate address)
16-bit	PCA8575	16-bit I ² C Fm QB GPIO with INT and PU
	PCF8575	16-bit I ² C Fm QB GPIO with INT and PU
	PCF8575C	16-bit I ² C Fm OD GPIO with INT
	PCA9535	16-bit I ² C Fm TP GPIO with INT
	PCA9535C	16-bit I ² C Fm OD GPIO with INT
	PCA9535A	16-bit I ² C Fm LV TP GPIO with INT
	PCAL9535A	16-bit I ² C Fm LV TP/OD GPIO with INT, latch and PU/PD
	+ PCA9539	16-bit I ² C Fm TP GPIO with INT and RST
	PCA9539R	16-bit I ² C Fm TP GPIO with INT and RST (state machine only)
	PCA9539A	16-bit I ² C Fm LV TP GPIO with INT and RST
	PCAL9539A	16-bit I ² C Fm LV TP/OD GPIO with INT, RST, latch and PU/PD
	PCA6416A	16-bit I ² C Fm LV VLT TP GPIO with INT and RST
	PCAL6416A	16-bit I ² C Fm LV VLT TP/OD GPIO with INT, RST, latch and PU/PD
	PCA9555	16-bit I ² C Fm TP GPIO with INT and PU
	PCA9555A	16-bit I ² C Fm LV TP GPIO with INT and PU
	PCAL9555A	16-bit I ² C Fm LV TP/OD GPIO with INT, latch and PU/PD (PU default)
	PCA9575	16-bit I ² C Fm LV VLT TP/OD GPIO with INT, RST, latch and PU/PD
	PCA9671	16-bit I ² C Fm+ QB GPIO with RST and PU
	PCA9673	16-bit I ² C Fm+ QB GPIO with INT, RST and PU
	PCA9675	16-bit I ² C Fm+ QB GPIO with INT and PU
	40-bit	PCA9505
PCA9506		40-bit I ² C Fm TP GPIO with INT, RST and OE
PCA9698		40-bit I ² C Fm+ TP/OD GPIO with INT, RST, OE and PU

Stepper Motor Controller		
1 motor controller	PCA9629	I ² C Fm+ Stepper Motor Controller with TP GPIO with INT and RST
	PCA9629A	Improved I ² C Fm+ Stepper Motor Controller with TP GPIO with INT and RST

Capacitive Sensor		
8-channel touch switch	+ PCA/PCF8885	I ² C Fm+ Touch / Proximity Sensor for up to 28 keys

Temp sensors		
Local	LM75B	I ² C Fm TS local with ± 2 °C accuracy and SMBus time-out
	SE95	I ² C Fm TS local with ± 1 °C accuracy (NRND)
	SE98A	I ² C FmDDR TS, no SPD, +/- 1°C accuracy and SMBus time-out
	PCT2075	I ² C Fm+ TS with +/- 1°C accuracy and SMBus time-out
	PCT2202	I ² C HSMS TS, 1.8 V, +/- 1°C accuracy and SMBus time-out
Local and EEPROM	SE97B	I ² C Fm DDR TS local with ± 1 °C accuracy, 2K SPD and SMBus time-out
Local and remote	NE1617A	I ² C Fm TS local with ± 2 °C accuracy and remote with ± 3 °C accuracy
	SA56004	I ² C Fm TS local with ± 2 °C accuracy and remote with ± 1 °C accuracy

LED controllers		
Dimmer (2 PWM, 25 mA / 5 V)	PCA9530	2-channel I ² C Fm OD LED dimmer with RST
	PCA9531	8-channel I ² C Fm OD LED dimmer with RST
	PCA9532	16-channel I ² C Fm OD LED dimmer with RST
	PCA9533	4-channel I ² C Fm OD LED dimmer
Blinker (2 PWM, 25 mA / 5 V)	PCA9550	2-channel I ² C Fm OD LED blinker with RST
	PCA9551	8-channel I ² C Fm OD LED blinker with RST
	PCA9552	16-channel I ² C Fm OD LED blinker with RST
	PCA9553	4-channel I ² C Fm OD LED blinker
Controller (PWM / Ch, 25 mA / 5 V)	PCA9632	4-channel I ² C Fm+ low-power TP LED controller
	PCA9633	4-channel I ² C Fm+ TP LED controller with OE
	PCA9634	8-channel I ² C Fm+ TP LED controller with OE
	+ PCA9635	16-channel I ² C Fm+ TP LED controller with OE
	+ PCA9685	16-channel I ² C Fm+ TP LED controller with 12-bit PWMs and OE
	+ PCA9955A	16-channel I ² C Fm+ 20 V CS LED controller
Controller (PWM/Ch, 57 mA / 20 V)	PCA9956A	24-channel I ² C Fm+ 20 V CS LED controller
	PCU9955A	16-channel I ² C UFm 20 V CS LED controller
	PCU9956A	24-channel I ² C UFm 20 V CS LED controller
Controller (PWM / Ch, 57 mA / 40 V)	+ PCA9952	16-channel I ² C Fm+ HV CS LED controller with OE
	+ PCA9955	16-channel I ² C Fm+ HV CS LED controller
Controller (PWM / Ch, 100 mA / 20 V)	PCA9655A	16-channel I ² C Fm+ 20 V OD LED Controller
	PCU9655A	16-channel I ² C UFm 20 V OD LED Controller
Controller (PWM / Ch, 100 mA / 40 V)	PCA9624	8-channel I ² C Fm+ HV OD LED controller with OE
	PCA9622	16-channel I ² C Fm+ HV OD LED controller with OE
	PCA9626	24-channel I ² C Fm+ HV OD LED controller with OE
	PCU9656	24-channel I ² C UFm HV OD LED controller with OE
LED flash	SSL3252	I ² C Fm 500 mA source dual LED flash with torch mode

Real-time clocks		
Low-power	PCA8802	I ² C Fm RTC for One Time Password generation and smart cards
	PCF85063	I ² C Fm / Tiny RTC with 30s, 60s interrupt
	PCF85063A	I ² C Fm / Tiny RTC with Alarm and 30s, 60s interrupt
	PCF85263A	I ² C Fm / Tiny RTC with Alarms, time stamp and battery back-up switch
	PCF85363A	I ² C Fm / Tiny RTC with Alarms, time stamp and battery back-up switch + 64Byte RAM
	PCF8523	I ² C Fm+ Ultra low-power RTC with loss of main power detection and automatic battery back-up
	PCF8563	I ² C Fm low-power clock/calendar
Automotive High temperature	+PCA85063A	I ² C Fm / Tiny RTC with Alarm and 30s, 60s interrupt -40°C...+105°C
	+PCA8565	I ² C Fm High temperature clock/calendar -40°C...+125°C
	+PCA2129T	I ² C Fm High-accuracy, low voltage RTC with time stamp
Temperature compensated high accuracy	PCF2127(A)	I ² C Fm High-accuracy, low-voltage RTC with time stamp and 512x8 RAM
	PCF2129(A)	I ² C Fm High-accuracy, low voltage RTC with time stamp

Muxes and switches		
2-channel	PCA9540B	2-channel I ² C Fm mux
	PCA9542A	2-channel I ² C Fm mux with INT
	PCA9543A/B	2-channel I ² C Fm switch with INT and RST
2-to-1 demux	PCA9541A/01	2 to 1 I ² C Fm demux with INT and RST (channel 0 default)
	PCA9541A/03	2 to 1 I ² C Fm demux with INT and RST (no channel default)
4-channel	PCA9544A	4-channel I ² C Fm mux with INT
	PCA9545A/B/C	4-channel I ² C Fm switch with INT and RST (B Alternate address)
	PCA9546A	4-channel I ² C Fm switch with RST
	PCA9646	4-channel I ² C Fm+ No Offset buffer/switch with RST
8-channel	PCA9547	8-channel I ² C Fm mux with RST (channel 0 default)
	PCA9548A	8-channel I ² C Fm switch with RST
Arbiter	PCA9641	2 masters to shared slave I ² C Fm+ arbiter with INT and RST (no channels selected at default)

Bus buffers			
Incremental Offset	PCA9510A	I ² C Fm Incremental Offset hot-swap bus buffer (no RTA)	
	PCA9511A	I ² C Fm Incremental Offset hot-swap-bus buffer	
	PCA9512A	I ² C Fm Incremental Offset VLT hot swap bus buffer	
	PCA9513A	I ² C Fm Incremental Offset hot-swap bus buffer (92 μA CS)	
	PCA9514A	I ² C Fm Incremental Offset hot-swap bus buffer (0.8 V offset)	
Differential Driver with Static Offset (1 side)	PCA9614	I ² C Fm+ VLT differential (4 wire) bus buffer	
	PCA9615	I ² C Fm+ VLT differential (4 wire) hot-swap bus buffer	
	PCA9616	I ² C Fm+ 0.8V LV VLT differential (4 wire) hot-swap bus buffer with INT (2 wire)	
Amplifier	P82B715	I ² C Fm HV bus extender	
No Offset	PCA9525	I ² C Fm (1 MHz) No Offset bus repeater	
	PCA9605	I ² C Fm+ No Offset bus repeater	
	PCA9646	4-channel I ² C Fm+ No Offset buffer / switch with RST	
	P82B96	I ² C Fm HV bus buffer	
Static Offset (1 side)	PCA9507	I ² C Fm VLT DDC buffer with accelerator	
	PCA9508	I ² C Fm VLT hot-swap bus repeater	
	PCA9509	I ² C Fm 1.0V LV VLT bus buffer with current source	
	PCA9509A	I ² C Fm 0.8V LV VLT bus buffer with current source	
	PCA9509P	I ² C Fm 0.8V LV VLT bus buffer	
	PCA9517A	I ² C Fm 0.9V LV VLT bus repeater	
	PCA9519	4-channel version of PCA9509	
	PCA9527	I ² C Fm DDC VLT buffer with accelerator and CEC	
	PCA9600	I ² C Fm+ HV bus buffer	
	PCA9601	I ² C Fm+ HV bus buffer with stronger 15 mA local side drive to support multiple Fm+ slaves	
	PCA9617A	I ² C Fm+ 0.8 V LV VLT bus repeater	
	Static Offset (All sides)	PCA9515A	I ² C Fm bus repeater
		PCA9516A	I ² C Fm 5-channel hub
PCA9518A		I ² C Fm expandable 5-channel hub	
Voltage translator (doesn't isolate capacitance)	GTL2000	22-bit I ² C Fm+ VLT	
	GTL2002	2-bit I ² C Fm+ VLT	
	GTL2003	8-bit I ² C Fm+ VLT	
	GTL2010	10-bit I ² C Fm+ VLT	
	PCA9306	Dual I ² C/SMBus Fm+ VLT	
	NVT2001	1-bit I ² C Fm+ VLT	
	NVT2002	2-bit I ² C Fm+ VLT for I ² C/SMBus applications	
	NVT2003	3-bit I ² C Fm+ VLT for two power supply applications	
	NVT2004	4-bit I ² C Fm+ VLT for SPI applications	
	NVT2006	6-bit I ² C Fm+ VLT	
NVT2008	8-bit I ² C Fm+ VLT		
NVT2010	10-bit I ² C Fm+ VLT		

Decode table

	Bus Speed		Features
Sm	100 kHz Standard-mode I ² C-bus	LV	Supply voltage <2.3 V
Fm	400 kHz Fast-mode I ² C-bus	TP	Totem-pole (push-pull)
Fm+	1 MHz Fast-mode Plus I ² C-bus	QB	Quasi-bidirectional
HSm	3.4 MHz High Speed-mode I ² C-bus	OD	Open drain
UFm	5 MHz Ultra Fast-mode I ² C-bus	CS	Current source
		INT	Interrupt
+	AEC-Q100 compliance	RST	Reset
GPIO	General Purpose I/O Expander	OE	Output enable
TS	Thermal Sensor	Latch	Input latch
RTC	Real Time Clock	PU	Pull-up resistors
LCD	Liquid Crystal Display	PU/PD	Pull-up/pull-down resistors
DAC	Digital Analog Converter	HV	Outputs >10 V
ADC	Analog Digital Converter	VLT	Voltage Level Translator – 2 Supplies
		COG	Chip on Glass

LCD drivers		
Segment driver	PCA8561 ¹⁾	I ² C Fm 72-segment low-power LCD driver in HVQFN32 package
	PCA/PCF85162	I ² C Fm 128-segment LCD driver in TSSOP48 package
	PCA85262	I ² C Fm 128-segment LCD driver with higher frame frequency in TSSOP48 package
	PCF8551 ¹⁾	I ² C Fm 144-segment low-power LCD driver with programmable frame frequency in TSSOP48 package
	PCA/PCF85176	I ² C Fm 160-segment LCD driver in TSSOP56 or TQFP64 package
	PCA85276	I ² C Fm 160-segment LCD driver with higher frame frequency in TSSOP56 package
	PCF8553 ¹⁾	I ² C Fm 160-segment low-power LCD driver with programmable frame frequency in TSSOP56 package
	PCA8546	I ² C Fm 176-segment LCD driver with programmable frame frequency in TSSOP56 package
	PCA8547	I ² C Fm 176-segment LCD driver with programmable frame frequency, charge pump, VLCD temperature compensation in TQFP64 package
	PCA/PCF85134	I ² C Fm 240-segment LCD driver in LQFP80 package
	PCA8543	I ² C Fm 240-segment LCD driver with programmable frame frequency, charge pump, VLCD temperature compensation in LQFP80 package
	PCF8545	I ² C Fm 320-segment LCD driver with programmable frame frequency in TSSOP56 package
	PCA/PCF8536	I ² C Fm 320-segment LCD driver with programmable frame frequency and LED backlight PWM control in TSSOP56 package
	PCA/PCF8537	I ² C Fm 352-segment LCD driver with programmable frame frequency, charge pump, VLCD temperature compensation in TQFP64 package
	PCA9620	I ² C Fm 480-segment LCD driver with programmable frame frequency, charge pump, VLCD temperature compensation in LQFP80 package
	PCA/PCF8576D	I ² C Fm 160-segment COG LCD driver
	PCA8576F	I ² C Fm 160-segment COG LCD driver with higher frame frequency and higher VLCD
	PCA/PCF85133	I ² C Fm 320-segment COG LCD driver with selectable frame frequency
	PCA85233	I ² C Fm 320-segment COG LCD driver with higher selectable frame frequency
	PCA8530 ¹⁾	I ² C Fm 408-segment COG LCD driver with programmable frame frequency, charge pump, VLCD temperature compensation
PCA/PCF85132	I ² C Fm 640-segment COG LCD driver with programmable frame frequency	
PCA85232	I ² C Fm 640-segment COG LCD driver with higher programmable frame frequency	
PCA/PCF8538	I ² C Fm 918-segment COG LCD driver with programmable frame frequency, charge pump, VLCD temperature compensation	
Character drivers	PCF2113	I ² C Fm 2 x 12 characters + 120-icon COG LCD driver with charge pump, VLCD temperature compensation
	PCF2116	I ² C 2 x 24 characters COG LCD driver with charge pump
	PCF2119	I ² C Fm 2 x 16 characters + 160-icon COG LCD driver with charge pump, VLCD temperature compensation
	PCF21219	I ² C Fm 2 x 16 characters + 160-icon COG LCD driver with higher frame frequency, charge pump, VLCD temperature compensation
	PCA2117	I ² C Fm 2 x 20 characters + 200-icon COG LCD driver with programmable frame frequency, charge pump, VLCD temperature compensation
Graphic driver	PCA8539	I ² C Fm 18 x 100-pixel COG LCD driver with programmable frame frequency, charge pump, VLCD temperature compensation
	PCF8531	I ² C Fm 34 x 128-pixel COG LCD driver with charge pump, VLCD temperature compensation
	PCF8811	I ² C Fm 80 x 100-pixel COG LCD driver with programmable frame frequency, charge pump, VLCD temperature compensation

A/D-D/A converters		
8-bit ADC	PCF8591	I ² C Fm 4-channel ADC and 1-channel DAC

EEPROMs		
2-kbit	PCA9500	I ² C Fm 256 x 8-bit EEPROM
	PCA9501	I ² C Fm 256 x 8-bit EEPROM
	PCF85103C	I ² C Sm 256 x 8-bit EEPROM (No programming time control output with ALT address)
	PCF8582C	I ² C Sm 256 x 8-bit EEPROM
4-kbit	PCF8570	I ² C Sm 256 x 8-bit RAM
	PCF8594C	I ² C Sm 1024 x 8-bit EEPROM
	SL3S4001	I ² C Fm 3.6K bit EEPROM with dual Gen2 RFID interface
8-kbit	PCA24S08A	I ² C Fm 1024 x 8-bit EEPROM with access protection
16-kbit	NT3H1101FHK	I ² C Fm 888 bytes EEPROM with dual interface NFC tag IC with power harvesting and field detect
	NT3H1201FHK	I ² C Fm 1904 bytes EEPROM with dual interface NFC tag IC with power harvesting and field detect
DIP switch	PCA8550	I ² C Fm 4-bit 1-of-2 mux & 5-bit EEPROM
	PCA9558	I ² C Fm 5-bit MP/1-bit latch & 6-bit EEPROM with 2K EEPROM and 8-bit GPIO
	PCA9559	I ² C Fm 5-bit mux/1-bit latch & 6-bit EEPROM
	PCA9560	I ² C Fm 2 x 5-bit mux/1-bit latch & 6-bit EEPROM
	PCA9561	I ² C Fm 4 x 6-bit mux & 6-bit EEPROM

Bridge and bus controllers		
Bridge	SC16IS740	I ² C Fm/SPI-to-UART bridge with IrDA
	SC16IS741	I ² C Fm/SPI-to-UART bridge with IrDA
	SC16IS750	I ² C Fm/SPI-to-UART bridge with IrDA and GPIO
	SC16IS752	I ² C Fm/SPI-to-DUART bridge with IrDA and GPIO
	SC16IS760	I ² C Fm/SPI-to-UART bridge with IrDA and GPIO
	SC16IS762	I ² C Fm/SPI-to-DUART bridge with IrDA and GPIO
	SC16IS850L	1.8 V I ² C Fm/SPI-to-UART bridge with IrDA
	SC18IM700	UART-to-I ² C Fm master bridge with GPIO
	SC18IS600	SPI-to-I ² C Fm master bridge, 4 M with GPIO
	SC18IS602	I ² C Fm slave-to-SPI master bridge
Controller	PCF8584	I ² C Sm bus controller with bus snoop
	PCA9564	I ² C Fm bus controller
	PCA9661	1-channel I ² C Fm+ bus controller with 4 K-byte buffer
	PCA9663	3-channel I ² C Fm+ bus controller with 4 K-byte buffer per channel
	PCA9665	I ² C Fm+ bus controller with 68-byte buffer
	PCA9665A	I ² C Fm+ bus controller with 68-byte buffer and restart condition fix
	PCU9661	1-channel U ² Fm bus controller with 4 K-byte buffer
PCU9669	1-channel Fm+ and 2-channel U ² Fm bus controller with 4 K-byte buffer per channel	

¹⁾ release H2 2014

Demo boards		
Bridges	OM6270	SPI/I ² C to UART Bridge Demoboard (SC16IS750 / SC16IS760)
	OM6271	SPI to I ² C Master Bridge Demoboard (SC18IS600)
	OM6272	UART to I ² C Master Bridge Demoboard (SC18IM700)
	OM6273	SPI/I ² C to Dual UART/IRDA/GPIO Demoboard (SC16IS752/SC16IS762)
	OM6274	I ² C to SPI Master Bridge Demoboard (SC18IS602)
Fm+ Universal	OM13257	Universal Temp Sensor Daughter card for Fm+ Demo board
	OM13303	GPIO Target Board for Fm+ Demo board with LED indicators and switches
	OM13320	Fm+ Demonstration Kit, including GPIO Target Board, Buffer Board and Bridge Board
	OM13488	Fm+ Demonstration Kit Universal 8-bit GPIO daughter card
	OM13489	Fm+ Demonstration Kit Universal 16-bit GPIO daughter card
	OM13491	Breakout Board Panel A VSSOP8,XQFN8,HWSON8,MSOP8
	OM13492	Breakout Board Panel B various 6, 8, &10-pin packages
	OM13493	Breakout Board Panel C DHVQFN 24, 20, 16, 14
	OM13494	Breakout Board Panel D HVQFN 14, 16, 20, 24
	OM13495	Breakout Board Panel E TSSOP 14, 16, 20, 24
I ² C-2005 Board	OM6275	I ² C 2005-1 Eval Board
	OM6281	PCA9698 Daughter Card for I ² C 2005-1
	OM6282	PCA9633 Daughter Card for I ² C 2005-1
	OM6293	PCA9600 Daughter Card for I ² C 2005-1
I ² C-2002 Board	OM6278	I ² C 2002-1A Eval Board
	OM6285	I ² C-2002-1A Eval Board w/o controller
LCD Driver	OM6290	LCD driver evaluation board: PCF8576D, PCF2119, PCF8531, PCA9633
	OM6292	PCA21125, PCF8562 demo board
	OM13500	PCA9620 demo board
	OM13500A	PCF8537 and PCA8537 demo board
	OM13501	PCF8538 and PCA8538 demo board
	OM13501A	PCF8538 and PCA8538 evaluation board
	OM13502 ¹⁾	PCA2117 demo board
Touch and Capacitive Sensor	OM11056	2 x PCF8885 Evaluation board: 16 channel touch switch for design support
	OM11057	PCF8885/PCF8886 capacitive sensors and PCF8536 LCD/LED driver demoboard
	OM11057A	OM11057 add-on board with high sensitivity slider
RTC	OM11059A	PCF85063TP & PCF85063ATL evaluation board
	OM13510	PCF85263 evaluation board
	OM13511	PCF8523 evaluation board
	OM13513	PCF2127 & PCF2129AT evaluation board
	OM13514	PCF85363 evaluation board
USB	OM13515	PCF85063AT evaluation board
	OM13518	USB-I ² C-bus dongle
Misc	OM13285	PCA9629 I ² C stepper motor demoboard & kit
	OM13312	SA636DK Evaluation Demo Board
	OM13313	TDA5051A PLM Demo Board Kit
	OM13314	TDA5051A Master/Slave Lighting demo kit
	OM13480	NVT4555UK Demo Board, NVT4555UK SIM Card Level Translator with LDO
	OM13485	NVT4556 demo board SIM Card level translator with I ² C-bus control and supply voltage LDO
	OM13534	SA605DK at 45MHz RF; 455kHz IF demo board
	OM13535	SA602AD + SA604AD at 45MHz RF; 455kHz IF demo board
Voltage Level Translator	OM13533	SA636BS at 240MHz RF; 10.7MHz IF demo board
	OM13315	NVT2001GM demoboard, single channel bi-directional voltage level translator
	OM13317	NVT2008PW demoboard, eight channel bi-directional voltage level translator
	OM13318	NVT2002DP demoboard, dual channel bi-directional voltage level translator
	OM13319	NVT2003DP demoboard, three channel bi-directional voltage level translator
	OM13323	NVT2006PW demoboard, six channel bi-directional voltage level translator
LED Driver	OM13324	NVT2010PW demoboard, ten channel bi-directional voltage level translator
	OM6276	PCA9633 Demo Board
	OM6277	PCA9564 Eval Board
	OM13269	PCA9632 LED 4 ch demoboard
	OM13321	PCA9956A LED Dimmer 24-channel Constant Current Demo Board I ² C Fm+
	OM13327	PCA9634 LED 8 ch demoboard
	OM13329	PCA9952 demoboard, LED Dimmer 16-channel constant current demoboard I ² C Fm+ (with output enable)
	OM13330	PCA9955 demoboard, LED Dimmer 16-channel constant current demoboard I ² C Fm+
	OM13331	PCU9955 demoboard, LED Dimmer 16-channel constant current demoboard 5 MHz UFM
	OM13332	PCA9685 demoboard, 16-channel voltage source with 12 bit PWM demoboard I ² C Fm+
	OM13333	PCA9635 demoboard, 16-channel voltage source with 8 bit PWM demoboard I ² C Fm+
	OM13482	PCU9956A LED Dimmer 24-channel Constant Current Demo Board I ² C 5 MHz UFM
	OM13483	PCA9955A 16-channel I ² C Fm+ constant current LED driver demo board
	OM13484	PCU9955A 16-channel I ² C UFM constant current LED driver demo board

¹⁾release H1 2014