

# TR1329

## TJA1100 Customer Evaluation Board - User Guide

Rev. 01.20 — 31 January 2018

User Manual

### Document information

Info	Content
<b>Title</b>	TJA1100 Customer Evaluation Board - User Guide
<b>Author(s)</b>	Steffen Lorenz; Simon Zhu
<b>Department</b>	Systems & Applications
<b>Keywords</b>	TJA1100, 100BASE-T1, Ethernet, PHY



**Revision history**

Rev	Date	Description
1.0	20160112	Initial version
1.1	20160816	Updated for board revision V6, with latest EMC filter and ESD protection <ul style="list-style-type: none"><li>- Fig. 1, 2, 4, 5, 6, 7, 8 updated</li><li>- Section 4.1: schematics updated</li></ul>
1.2	20180131	Updated for board revision V7, with latest MDI circuitry and new connector <ul style="list-style-type: none"><li>- CE compliancy statement added</li><li>- Fig. 1, 2, 3, 4, 5, 6, 7 updated</li><li>- Section 2.2.1 description of bit strapping added</li><li>- Section 4.1 schematics updated</li></ul>

**Contact information**

For more information, please visit: <http://www.nxp.com>

For sales office addresses, please send an email to: [salesaddresses@nxp.com](mailto:salesaddresses@nxp.com)

## 1. Introduction

This document describes the usage of the TJA1100 Customer Evaluation Board. The Board supports the evaluation of the TJA1100 with providing (MII) a 40-pins standard header (including MII/SMI/control signals/power supplies. Details can be found in section 2.3.1) with 2,54mm pinning distance to a host controller board, the bus interface (MDI) including a screw terminal (SMKDS) connector as well as needed components for the power supply and operation. Further information is given in the following sections.

**Please note:** the evaluation board has been designed for functional evaluation of the PHY in your environment. The evaluation board is not intended for EMC or compliance qualification measurements.

This product has not undergone formal EU EMC assessment. As a component used in a research environment, it will be the responsibility of the user to ensure the finished assembly does not cause undue interference when used and cannot be CE marked unless assessed.

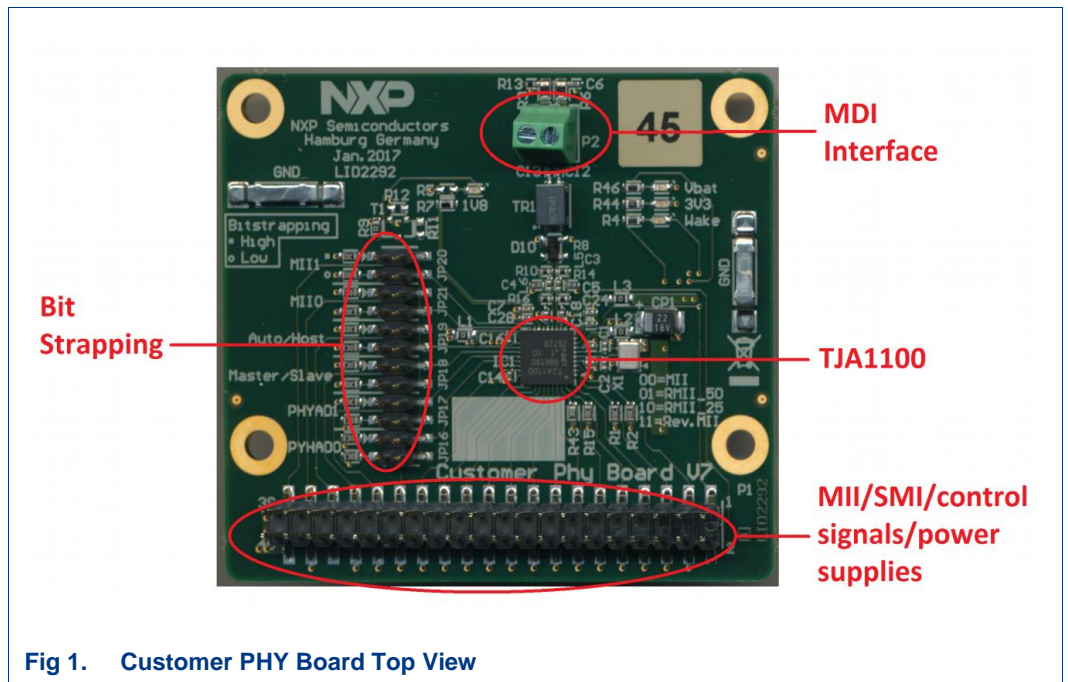

Fig 1. Customer PHY Board Top View

## 1.1 Acronyms

Table 1. Acronyms used in the document

Acronym	Description
BAT	Battery
DC	Direct Current
GND	Ground
MAC	Medium Access Controller
MDI	Medium Dependent Interface
MII	Medium Independent Interface
PHY	Physical
uC	Microcontroller

## 2. Board Setup

### 2.1 PHY Assembly

The TJA1100 is provided in a HVQFN-36 package (8x8sqmm). In case the TJA1100 on the customer evaluation board must be changed, please ensure the correct placement. The Pin 1 is located at the bottom right and is marked with a small white arrow (see Fig 2).

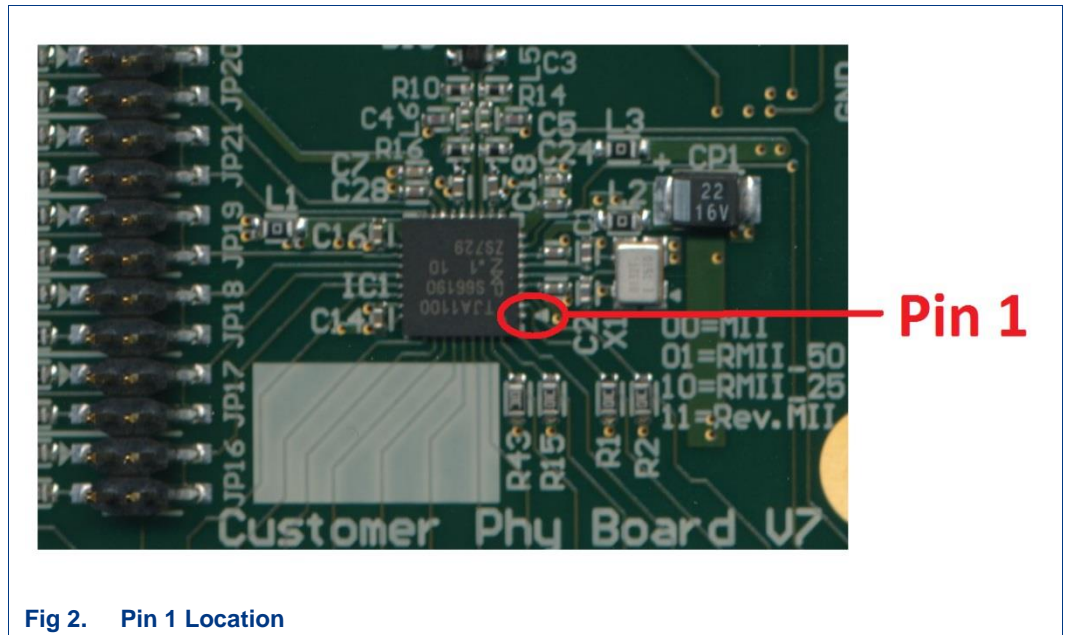

Fig 2. Pin 1 Location

### 2.2 Jumper Settings

#### 2.2.1 Bit Strapping

The TJA1100 has several configuration pins for a pre-configuration during startup. The following tables give an overview of the related jumpers and possible configurations, as shown also in Fig 3. At the PCB (Fig 4) the orientation for High (H) and Low (L) is marked.

**Please note:** all pre-configuration (except for the PHY addresses) can be overwritten via SMI command.

PHY address is used for the SMI address and for initialization of the Cipher scrambler key. The PHY address is five bits (PHYAD4...PHYAD0), and PHYAD4 is the MSB of the address.

PHYAD[4:2] are set to "001" in the TJA1100. PHYAD[1:0] are pre-determined by bit strapping.

**Table 2. Bit Strapping PHY-address**

Jumper	Function	Address 4	Address 5	Address 6	Address 7
JP16	Configuration of PHYAD0	L	H	L	H
JP17	Configuration of PHYAD1	L	L	H	H

The TJA1100 can be configured as Master or Slave, as well as Managed or Autonomous operation. When the TJA1100 is configured for Autonomous operation, the PHY will automatically enter Normal mode and activate the link on power-on without further interaction with a host controller.

**Table 3. Bit Strapping Master/Slave Configuration**

Jumper	Function	Master	Slave
JP18	Configuration of CONFIG0	H	L

**Table 4. Bit Strapping Managed/autonomous Operation**

Jumper	Function	Managed	Autonomous
JP19	Configuration of CONFIG1	L	H

The TJA1100 provides below MII modes, which can be configured via bit strapping.

**Table 5. Jumper Settings for Bit Strapping**

Jumper	Function	MII	RMII 50MHz	RMII 25MHz	Reverse MII
JP21	Configuration of CONFIG2	L	H	L	H
JP20	Configuration of CONFIG3	L	L	H	H

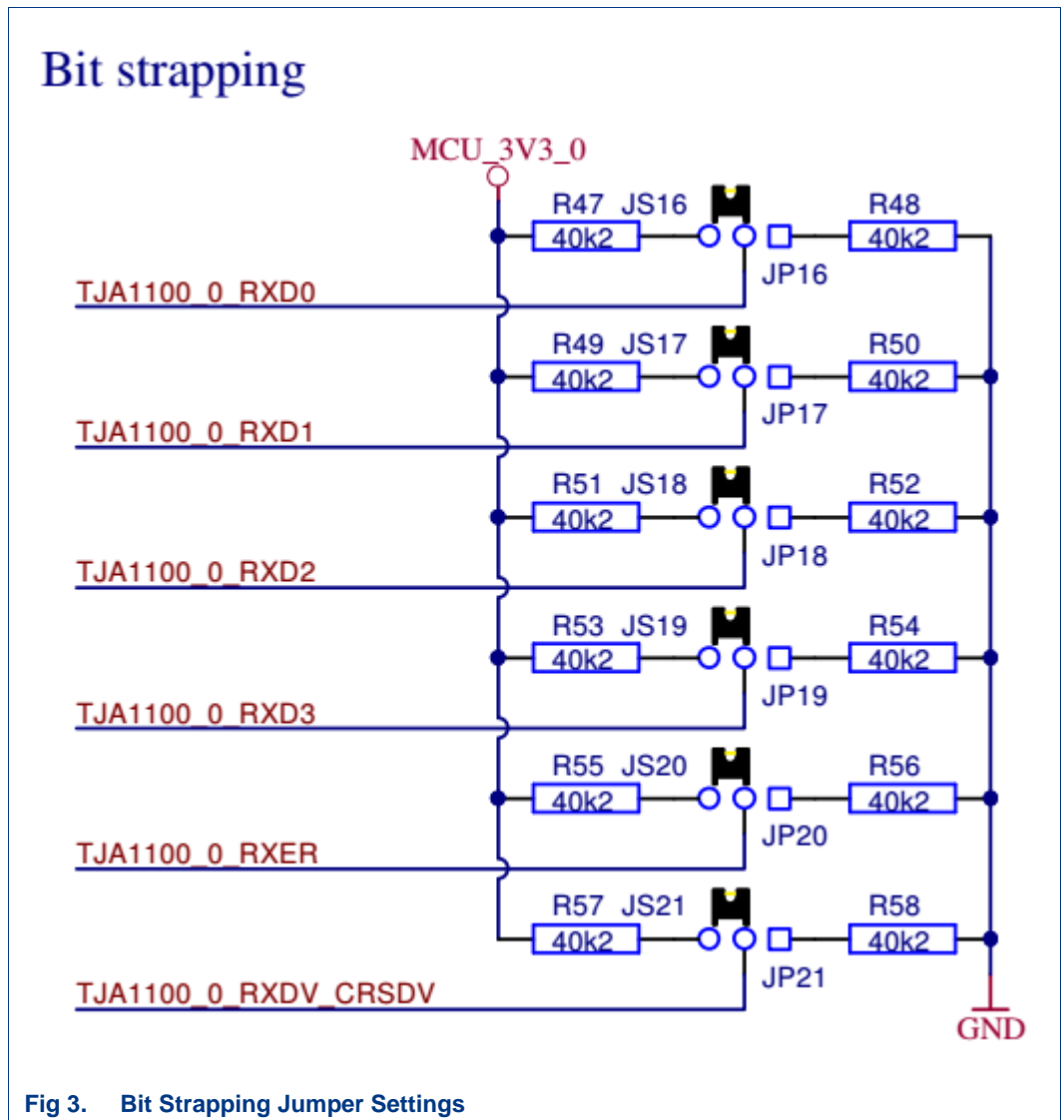

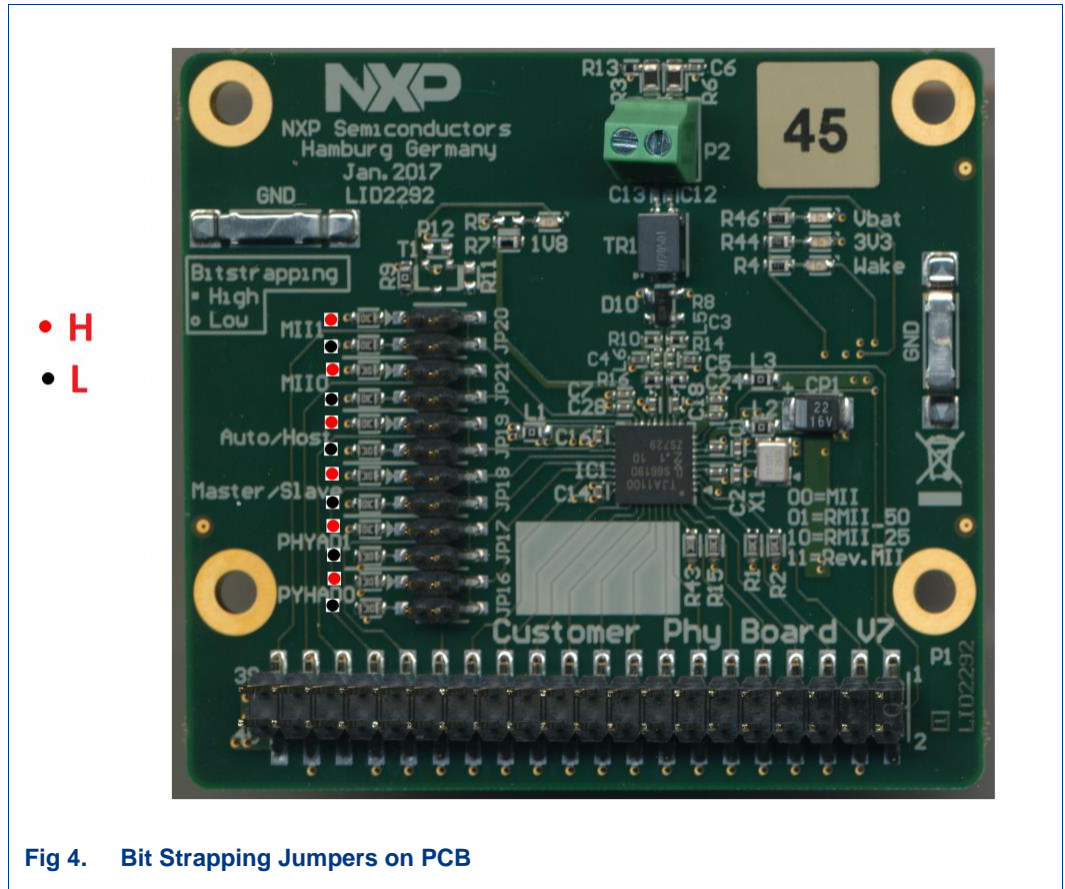

Fig 4. Bit Strapping Jumpers on PCB



## 2.3 Connectors & LEDs

### 2.3.1 MII Connector

For the MII a double row, 40 pin 2.54x2.54mm male header P1 (Fig 5) is used. At the PCB (Fig 5Error! Reference source not found.) the pinning order is marked.

The pinning order of the MII connector is given in 0.

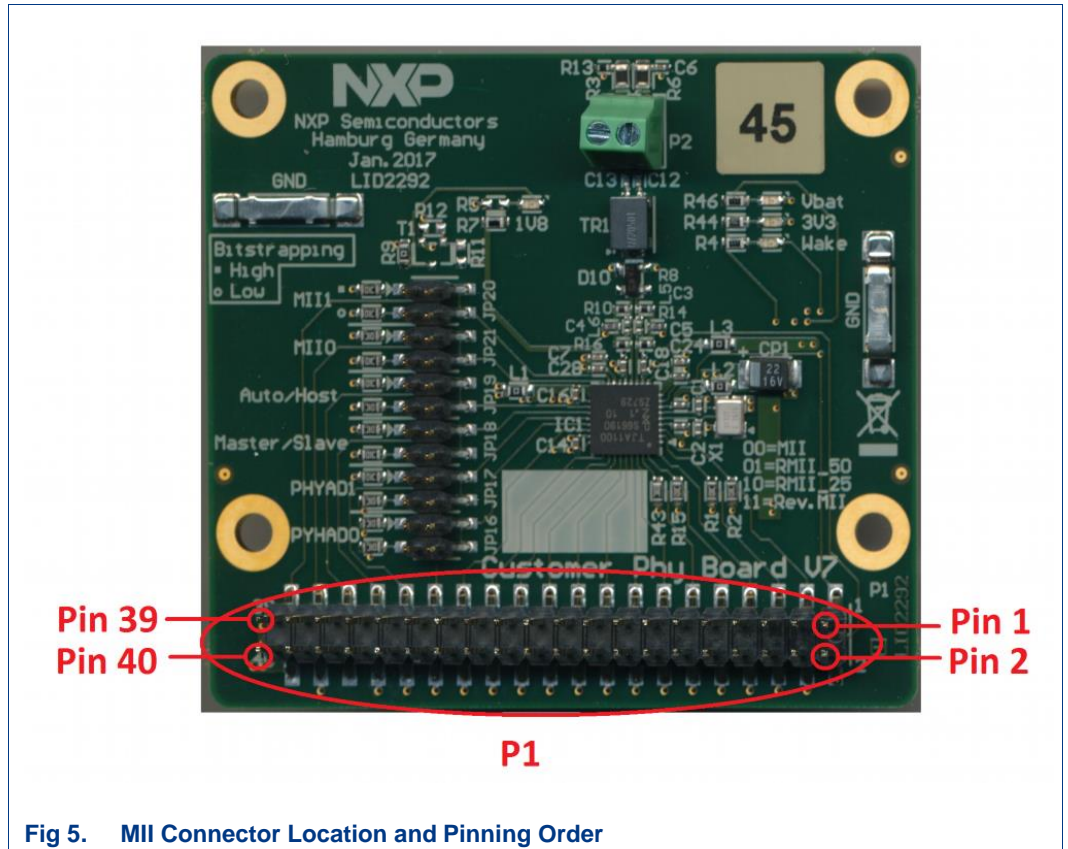

Fig 5. MII Connector Location and Pinning Order

**Table 6. MII Connector Pinning**

Pin	Signal	Signal	Pin
1	TJA1100_WAKE	TJA1100_INH	2
3	TJA1100_RSTN	GND	4
5	TJA1100_INT	GND	6
7	TJA1100_MDC	GND	8
9	TJA1100_MDIO	GND	10
11	TJA1100_EN	GND	12
13	TJA1100_TXER	GND	14
15	TJA1100_TXD0	GND	16
17	TJA1100_TXD1	GND	18
19	TJA1100_TXD2	GND	20
21	TJA1100_TXD3	GND	22
23	TJA1100_TXEN	GND	24
25	TJA1100_TXCLK	GND	26
27	TJA1100_RXCLK	GND	28
29	TJA1100_RXD0	GND	30
31	TJA1100_RXD1	GND	32
33	TJA1100_RXD2	GND	34
35	TJA1100_RXD3	3V3	36
37	TJA1100_RXDV	GND	38
39	TJA1100_RXER	BAT	40

2.3.2 MDI Connector

For the MDI interface, a two position PCB terminal connector (SMKDS, 5/2-2.54) from Phoenix Contact is used, and the details are given in Fig 6.

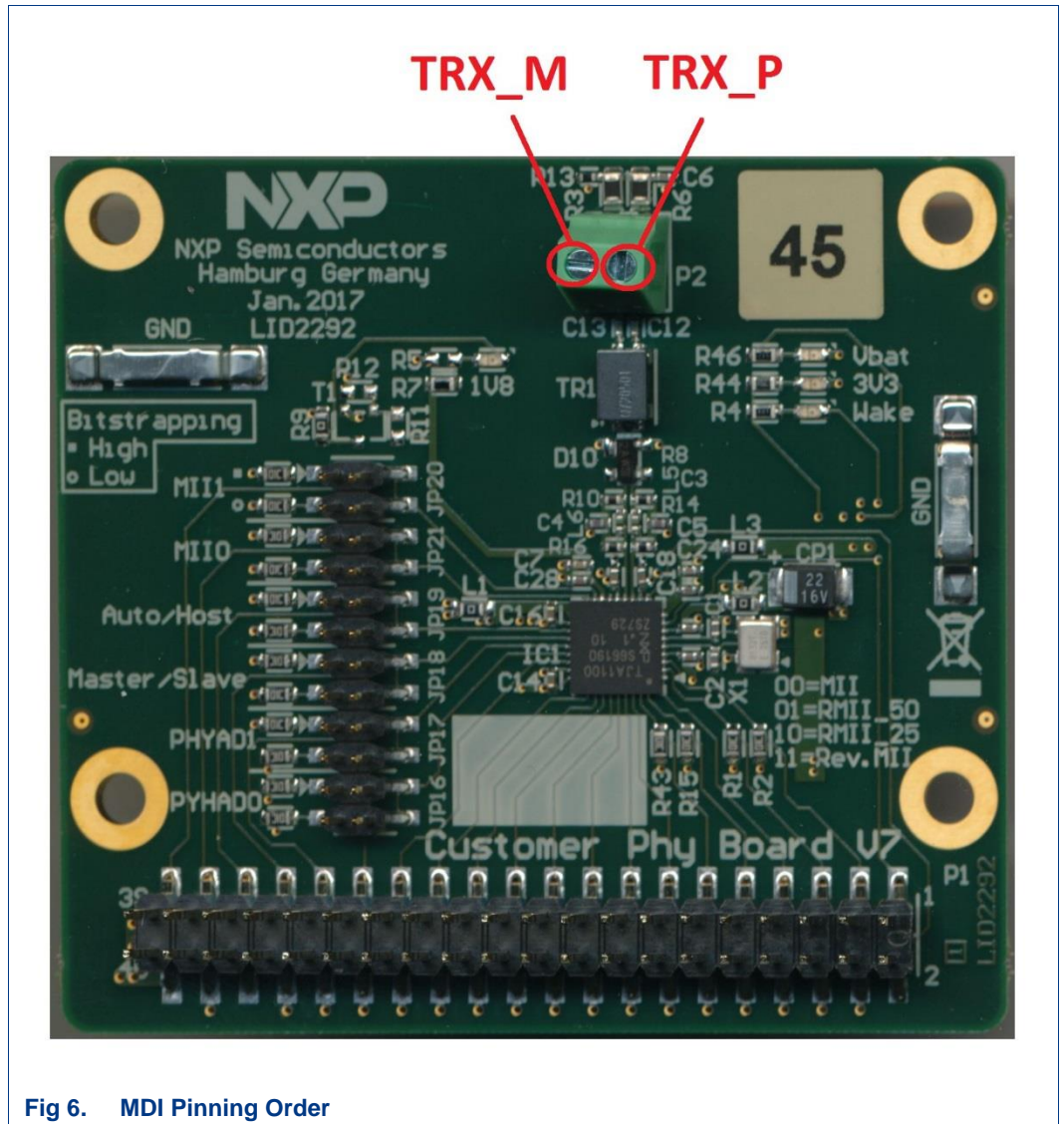

Fig 6. MDI Pinning Order

2.3.3 LEDs

The LEDs on the Board can be used to evaluate the status of the Board. Fig 7 shows all the LEDs on the Board, and Table 7 sums up the meaning of each LED.

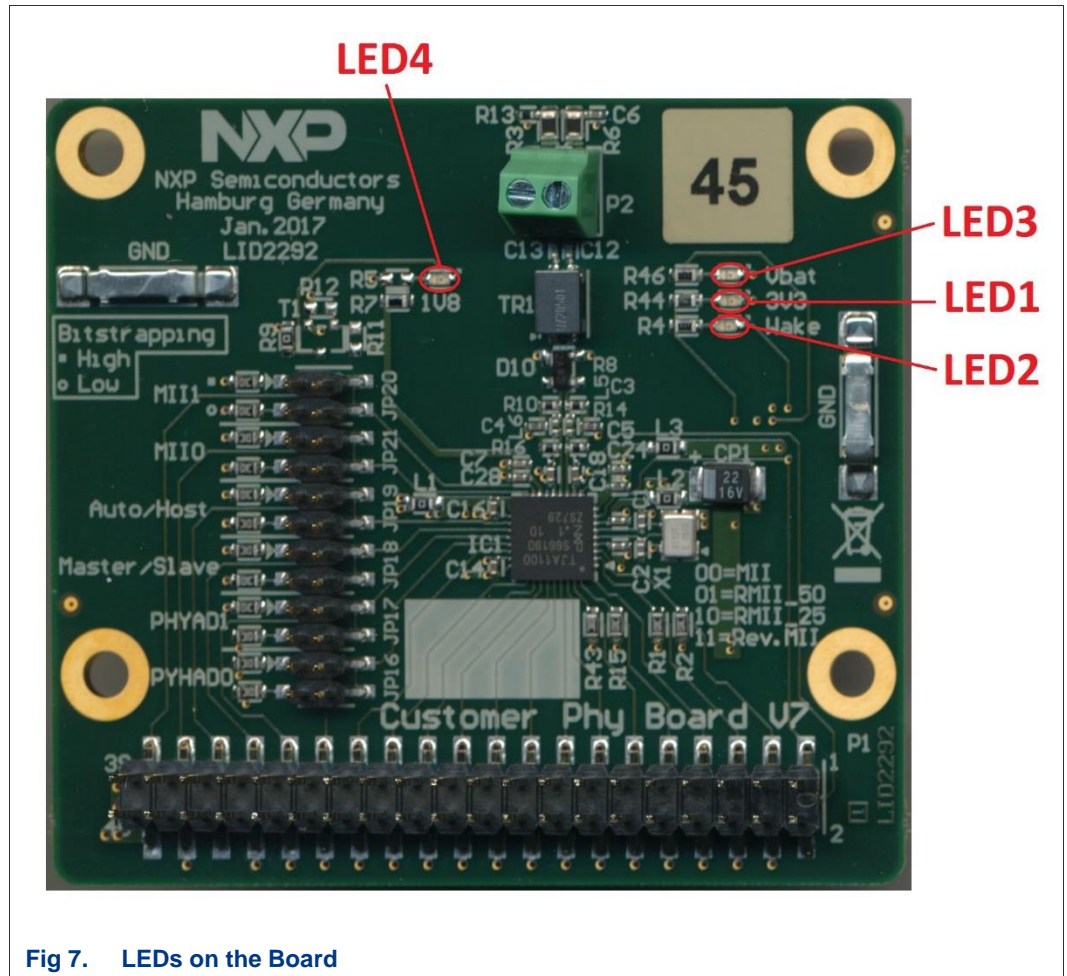

Fig 7. LEDs on the Board

Table 7. Descriptions of LEDs

LED	Description
LED1	TJA1100 3V3 Power Supply Status (ON: 3V3 is present)
LED2	TJA1100 Local Wake-up Status (Flashing: a Local Wake-up is detected)
LED3	TJA1100 Battery Power Supply Status (ON: Battery is present)
LED4	TJA1100 1V8 Digital Power Supply Status (ON: 1V8 is present)

### 3. Reference

---

[1] TJA1100 Datasheet, Version 3, 23 May, 2017

## 4. Appendix

### 4.1 The TJA1100 Customer Evaluation Board Schematics

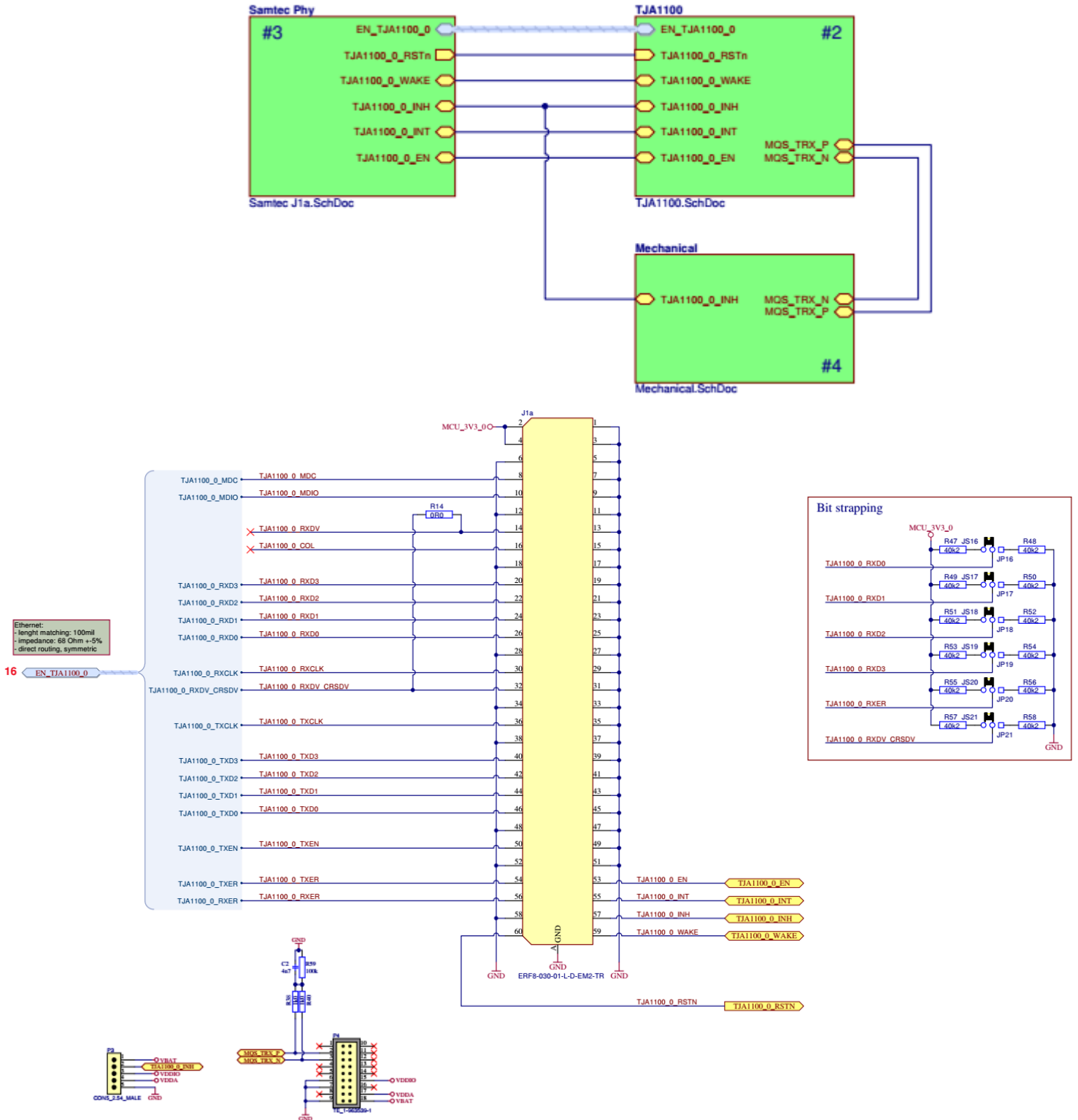

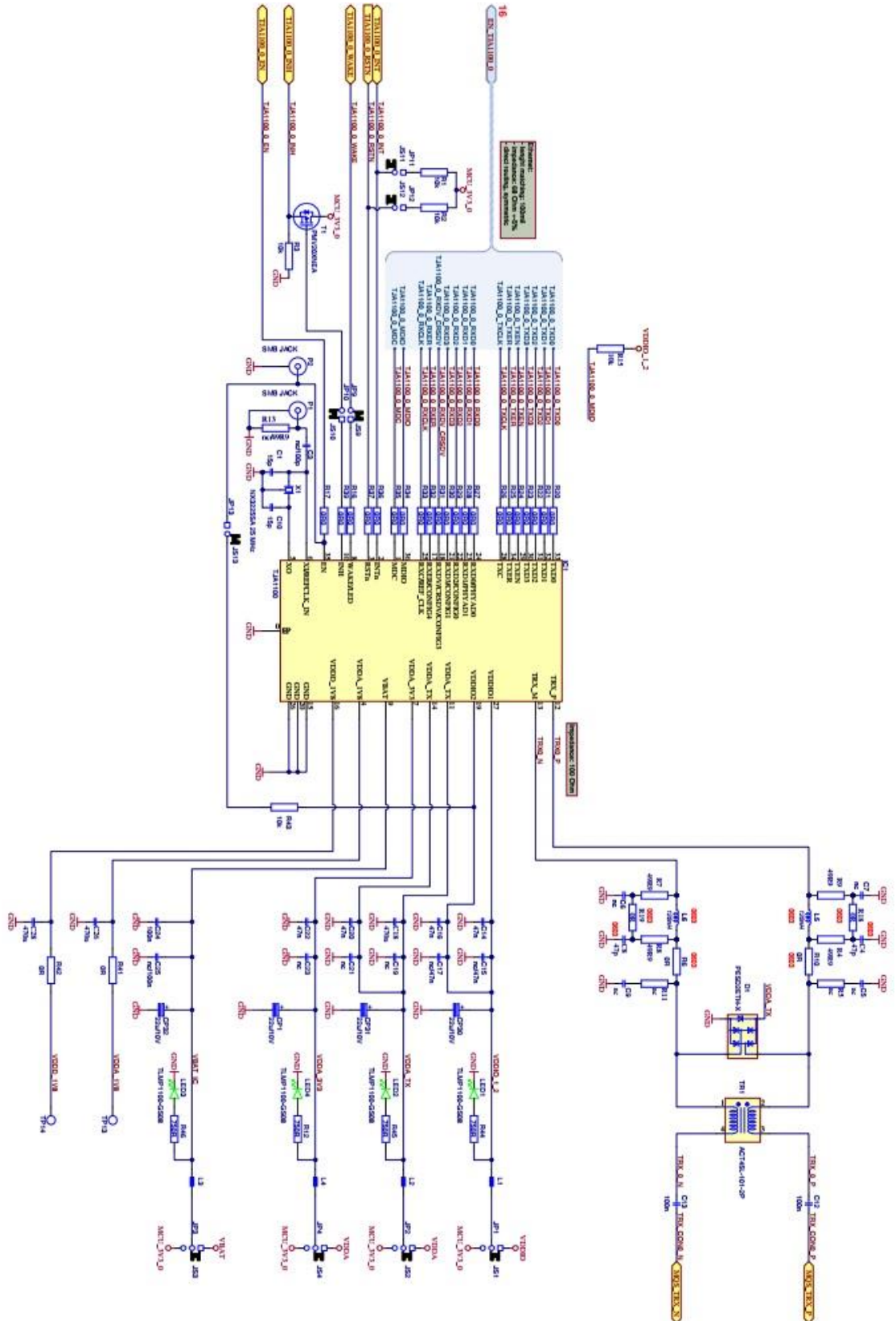

## 5. Legal information

### 5.1 Definitions

**Draft** — The document is a draft version only. The content is still under internal review and subject to formal approval, which may result in modifications or additions. NXP Semiconductors does not give any representations or warranties as to the accuracy or completeness of information included herein and shall have no liability for the consequences of use of such information.

### 5.2 Disclaimers

**Limited warranty and liability** — Information in this document is believed to be accurate and reliable. However, NXP Semiconductors does not give any representations or warranties, expressed or implied, as to the accuracy or completeness of such information and shall have no liability for the consequences of use of such information.

In no event shall NXP Semiconductors be liable for any indirect, incidental, punitive, special or consequential damages (including - without limitation - lost profits, lost savings, business interruption, costs related to the removal or replacement of any products or rework charges) whether or not such damages are based on tort (including negligence), warranty, breach of contract or any other legal theory.

Notwithstanding any damages that customer might incur for any reason whatsoever, NXP Semiconductors' aggregate and cumulative liability towards customer for the products described herein shall be limited in accordance with the Terms and conditions of commercial sale of NXP Semiconductors.

**Right to make changes** — NXP Semiconductors reserves the right to make changes to information published in this document, including without limitation specifications and product descriptions, at any time and without notice. This document supersedes and replaces all information supplied prior to the publication hereof.

**Suitability for use** — NXP Semiconductors products are not designed, authorized or warranted to be suitable for use in life support, life-critical or safety-critical systems or equipment, nor in applications where failure or malfunction of an NXP Semiconductors product can reasonably be expected to result in personal injury, death or severe property or environmental damage. NXP Semiconductors accepts no liability for inclusion and/or use of NXP Semiconductors products in such equipment or applications and therefore such inclusion and/or use is at the customer's own risk.

**Applications** — Applications that are described herein for any of these products are for illustrative purposes only. NXP Semiconductors makes no

representation or warranty that such applications will be suitable for the specified use without further testing or modification.

Customers are responsible for the design and operation of their applications and products using NXP Semiconductors products, and NXP Semiconductors accepts no liability for any assistance with applications or customer product design. It is customer's sole responsibility to determine whether the NXP Semiconductors product is suitable and fit for the customer's applications and products planned, as well as for the planned application and use of customer's third party customer(s). Customers should provide appropriate design and operating safeguards to minimize the risks associated with their applications and products.

NXP Semiconductors does not accept any liability related to any default, damage, costs or problem which is based on any weakness or default in the customer's applications or products, or the application or use by customer's third party customer(s). Customer is responsible for doing all necessary testing for the customer's applications and products using NXP Semiconductors products in order to avoid a default of the applications and the products or of the application or use by customer's third party customer(s). NXP does not accept any liability in this respect.

**Export control** — This document as well as the item(s) described herein may be subject to export control regulations. Export might require a prior authorization from competent authorities.

### 5.3 Licenses

#### Purchase of NXP <xxx> components

<License statement text>

### 5.4 Patents

Notice is herewith given that the subject device uses one or more of the following patents and that each of these patents may have corresponding patents in other jurisdictions.

<Patent ID> — owned by <Company name>

### 5.5 Trademarks

Notice: All referenced brands, product names, service names and trademarks are property of their respective owners.

<Name> — is a trademark of NXP B.V.



6. List of figures

Fig 1. Customer PHY Board Top View.....3  
Fig 2. Pin 1 Location .....5  
Fig 3. Bit Strapping Jumper Settings.....7  
Fig 4. Bit Strapping Jumpers on PCB .....8  
Fig 5. MII Connector Location and Pinning Order .....9  
Fig 6. MDI Pinning Order ..... 11  
Fig 7. LEDs on the Board..... 12

## 7. List of tables

---

Table 1. Acronyms used in the document.....4  
Table 2. Bit Strapping PHY-address .....6  
Table 3. Bit Strapping Master/Slave Configuration .....6  
Table 4. Bit Strapping Managed/autonomous Operation 6  
Table 5. Jumper Settings for Bit Strapping .....6  
Table 6. MII Connector Pinning ..... 10  
Table 7. Descriptions of LEDs ..... 12