

UM10935

PN7150 NFC controller SBC kit

Rev. 1.7 — 14 June 2021

348017

User manual
COMPANY PUBLIC

Document information

Information	Content
Keywords	OM5579, PN7150, demo kit, Raspberry Pi, BeagleBone, Arduino
Abstract	This document is the user manual of the PN7150 NFC controller SBC kit.



1 Revision history

Revision history

Rev	Date	Description
1.7	20210614	Moved to OM5579 because of OM5578 discontinuation
1.6	20210209	Removed Windows IoT support
1.5	201907210	Aligned settings configuration across documentation
1.4	20170302	Updated schematics with final components values Removed weblinks redirection
1.3	20170104	Added errata about first demo kits limitation Added CE certification details
1.2	20160707	Added demo kit performance details
1.1	20160518	<ul style="list-style-type: none">• Updated with kit pictures and FCC statement change• Security status changed into "COMPANY PUBLIC"
1.0	20151210	First official release version

2 Introduction

The present document describes the OM5579/PN7150 demonstration kit, a flexible and easy-to-use Single Board Computer (SBC) Kit for the PN7150 NFC controller.

It enables the development of an NFC solution based on PN7150 in a Linux or Android environment or even in system based on RTOS or without OS.

It exists in different configurations:

- OM5579/PN7150RPI to be used with Raspberry Pi platform (see [\[1\]](#))
- OM5579/PN7150BBB to be used with BeagleBone interface board (see [\[2\]](#))
- OM5579/PN7150ARD to be used with platforms offering Arduino compatible interface (see [\[3\]](#)), like LPCXpresso (see [\[5\]](#)) or Kinetis Freedom (see [\[4\]](#)).

This document presents first an overview of the kit.

Then, it gives printed circuit boards details.

Finally, it provides information for reuse of the kit in different environments.

The main limitation of the beta release resides in the missing support for the TEST_GET_REGISTER_CMD/RSP (see description in UM10936 [\[7\]](#) chapter §12.4) which may be used during the matching process (as described in AN11755 [\[8\]](#) chapter).

OM5579/PN7150 demonstration kit replaces previous OM5578/PN7150 demonstration kit now discontinued.

3 Overview

3.1 Kit description

All 3 OM5579/PN7150 kits contain a PN7150 NFC controller board, a dedicated interface board, as well as an NFC sample card in form of an NFC Forum Type 2 Tag.

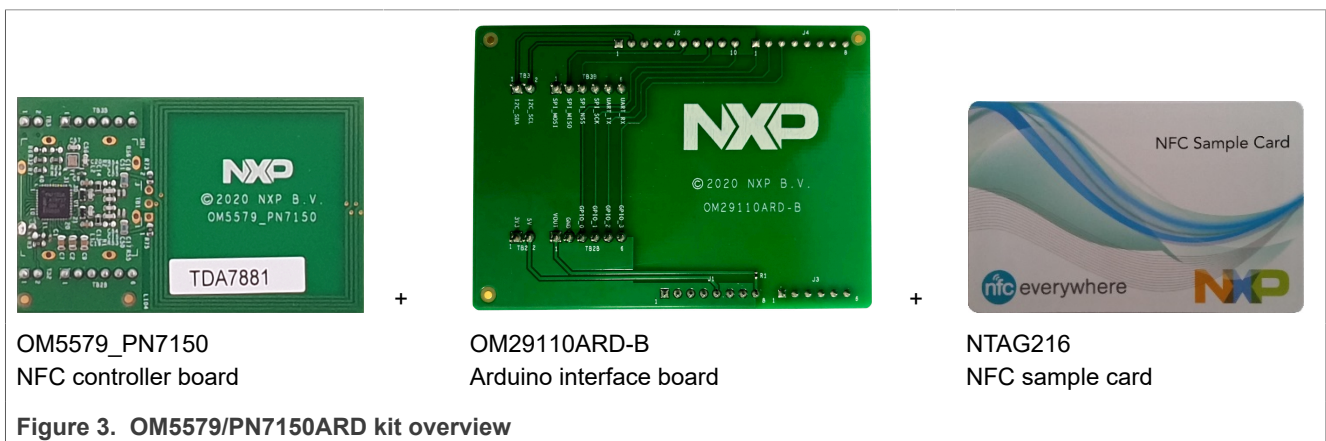

3.2 PN7150 NFC controller board

The OM5579_PN7150 NFC controller board is high performance fully NFC-compliant expansion board, meeting compliance with reader mode, P2P mode and card emulation mode standards.

The board features an integrated high performance RF antenna to insure high interoperability level with NFC devices.

It has to be used in association with one interface board according to the targeted user environment. For this purpose, it integrates the NFC generic interface allowing assembly with OM29110 interface boards (see [\[6\]](#)).

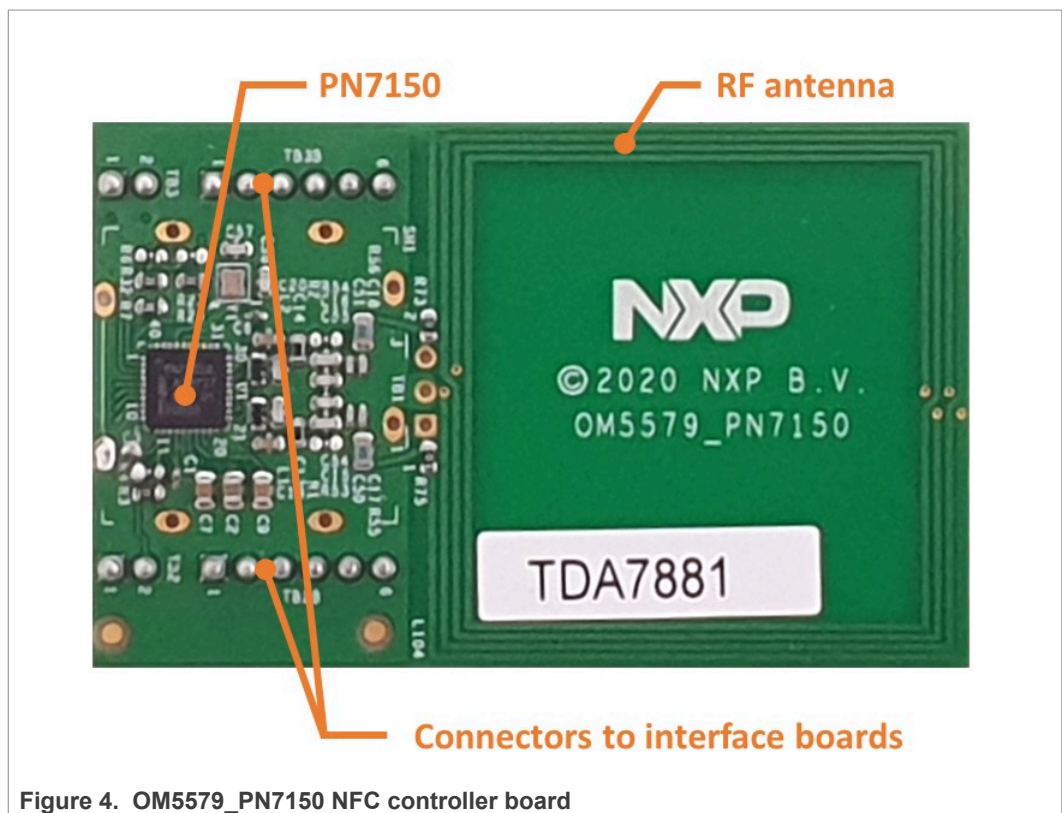

3.3 OM29110 interface boards

The OM29110 interface boards offer support for connection to Raspberry Pi, BeagleBone or Arduino compatible interface platforms (refer to [6] for more details).

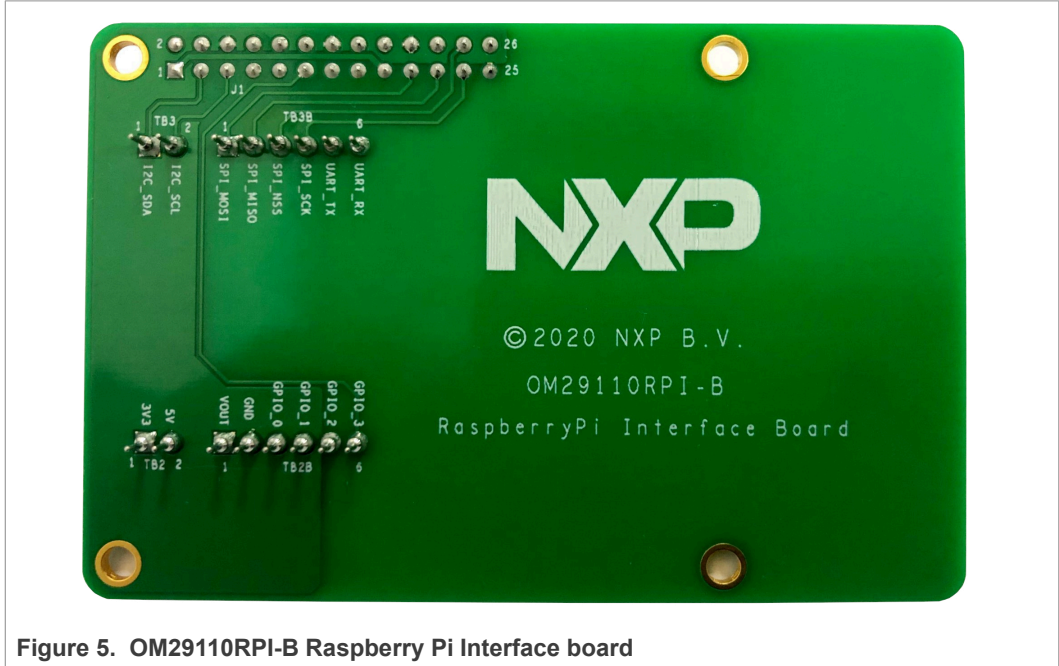

Figure 5. OM29110RPI-B Raspberry Pi Interface board



Figure 6. OM29110BBB-B BeagleBone interface board

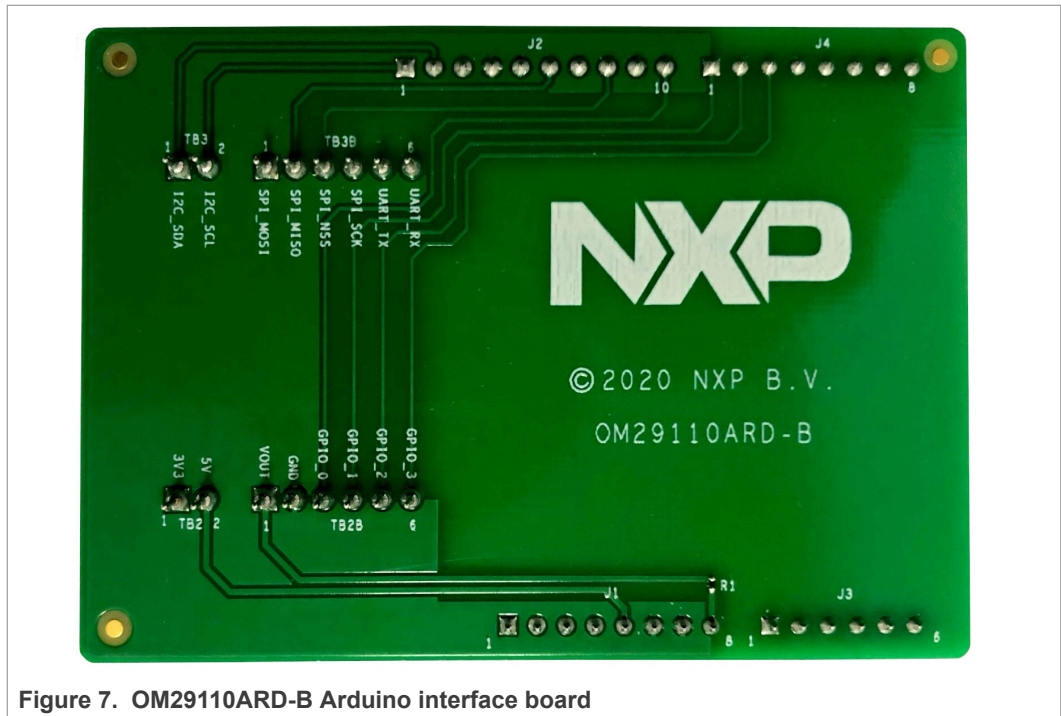

Figure 7. OM29110ARD-B Arduino interface board

3.4 NFC sample card

OM5579/PN7150 kit includes an NFC sample card, based on NTAG216 tag IC, allowing to demonstrate NFC reader capabilities of PN7150 NFC controller.

For the current purpose of PN7150 NFC controller demonstration, the card has been pre-configured with an NDEF URI type message.

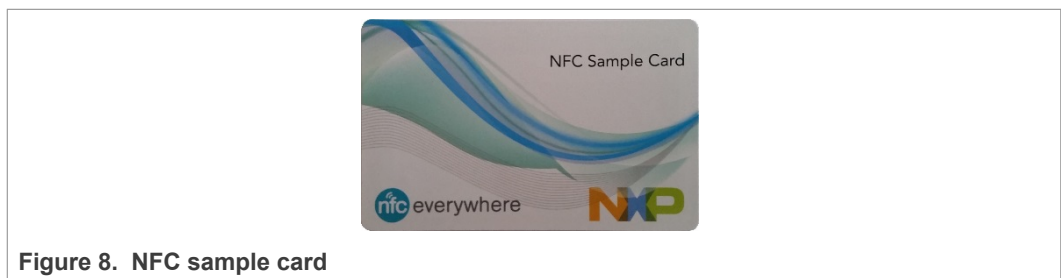

Figure 8. NFC sample card

4 PN7150 NFC controller board details

4.1 Schematics

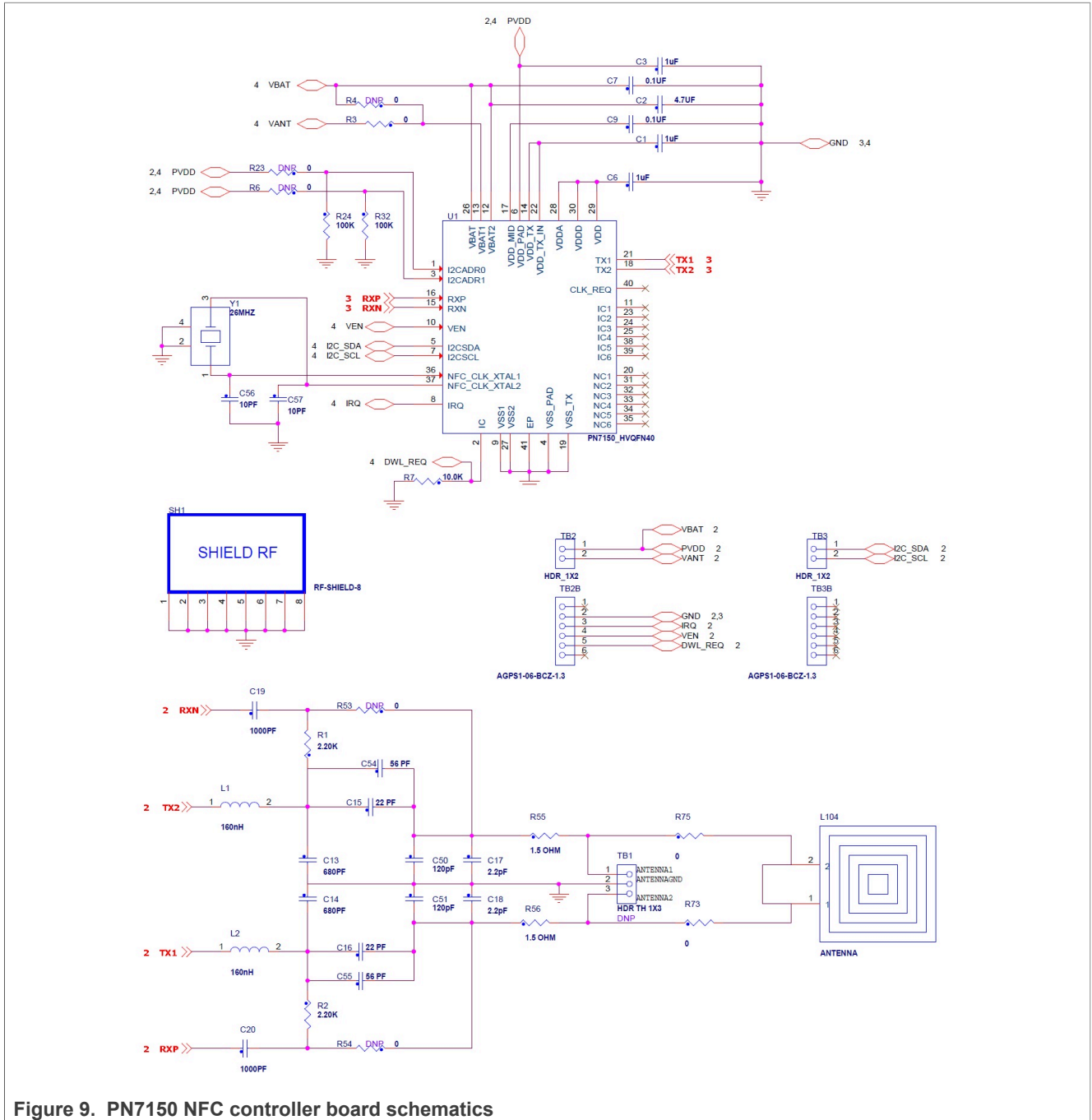

Figure 9. PN7150 NFC controller board schematics

4.2 Layout

4.2.1 Components layers

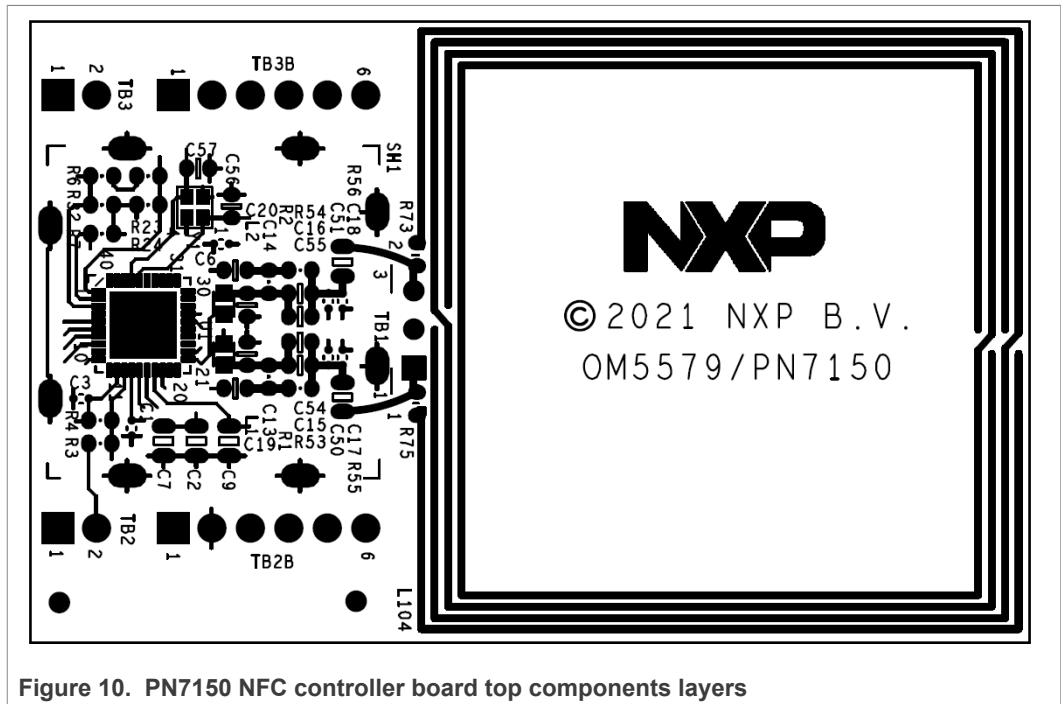

Figure 10. PN7150 NFC controller board top components layers

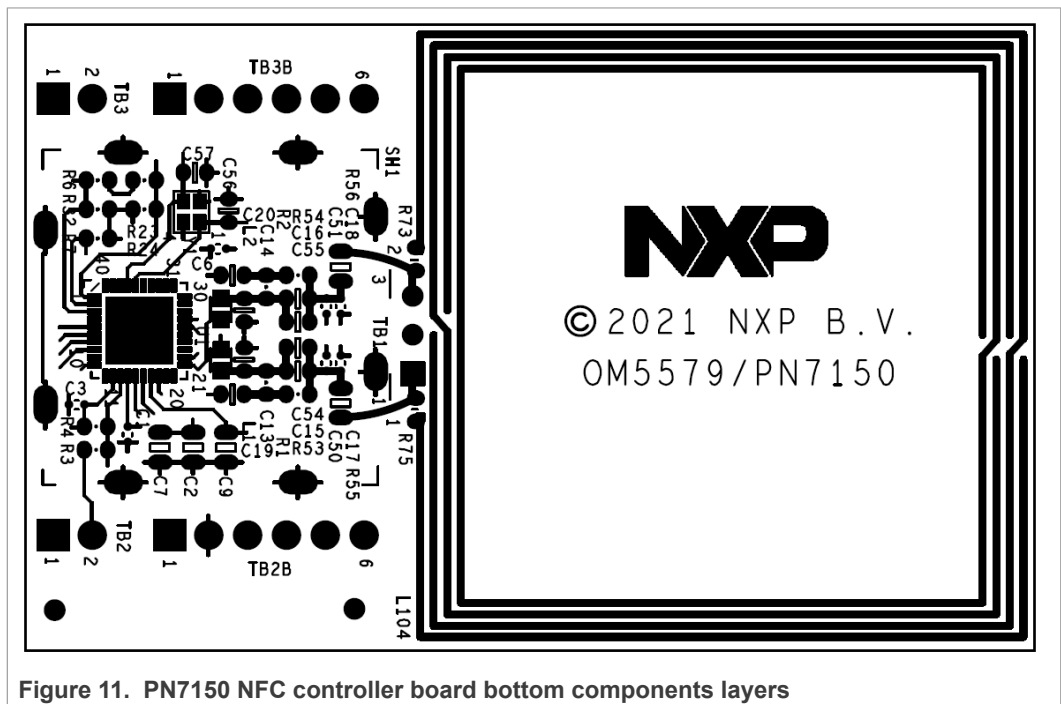

Figure 11. PN7150 NFC controller board bottom components layers

4.2.2 Layer 1

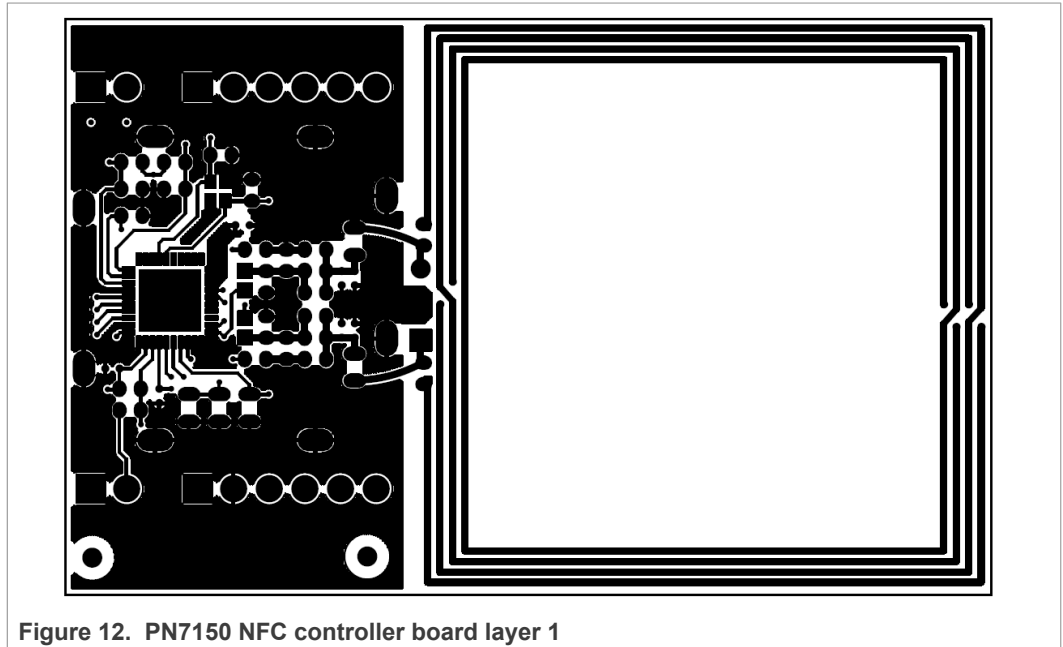

Figure 12. PN7150 NFC controller board layer 1

4.2.3 Layer 2

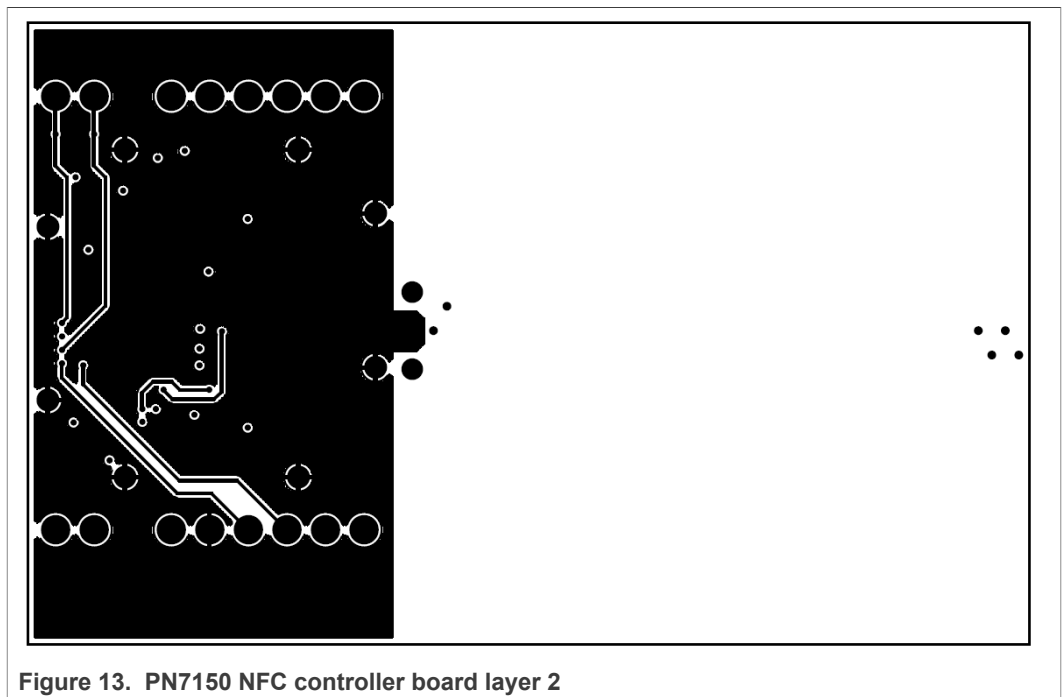

Figure 13. PN7150 NFC controller board layer 2

4.2.4 Layer 3

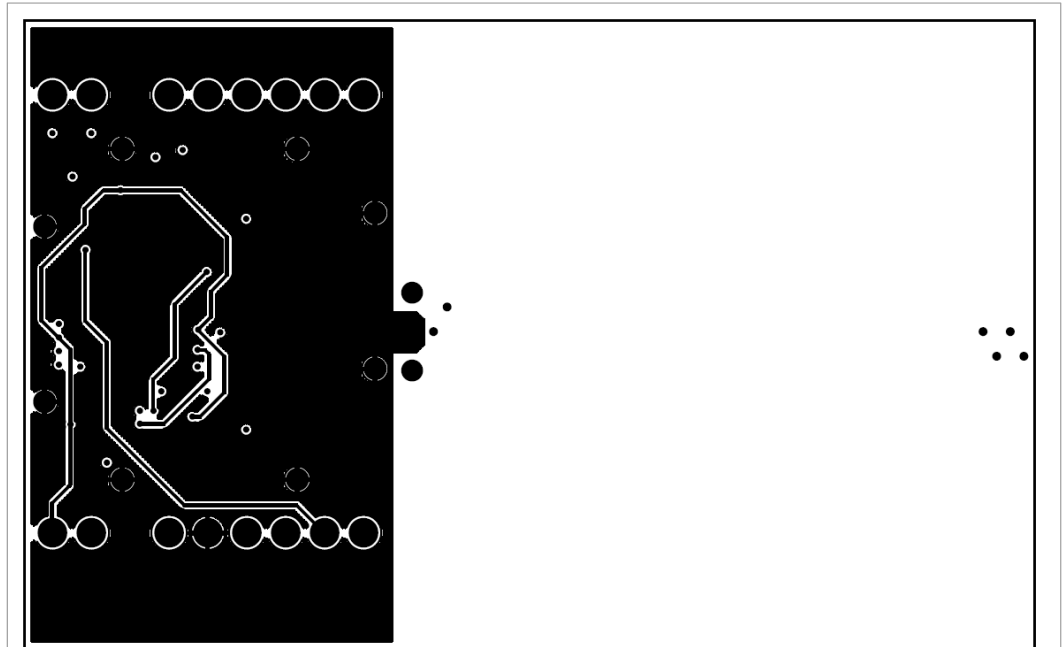

Figure 14. PN7150 NFC controller board layer 3

4.2.5 Layer 4

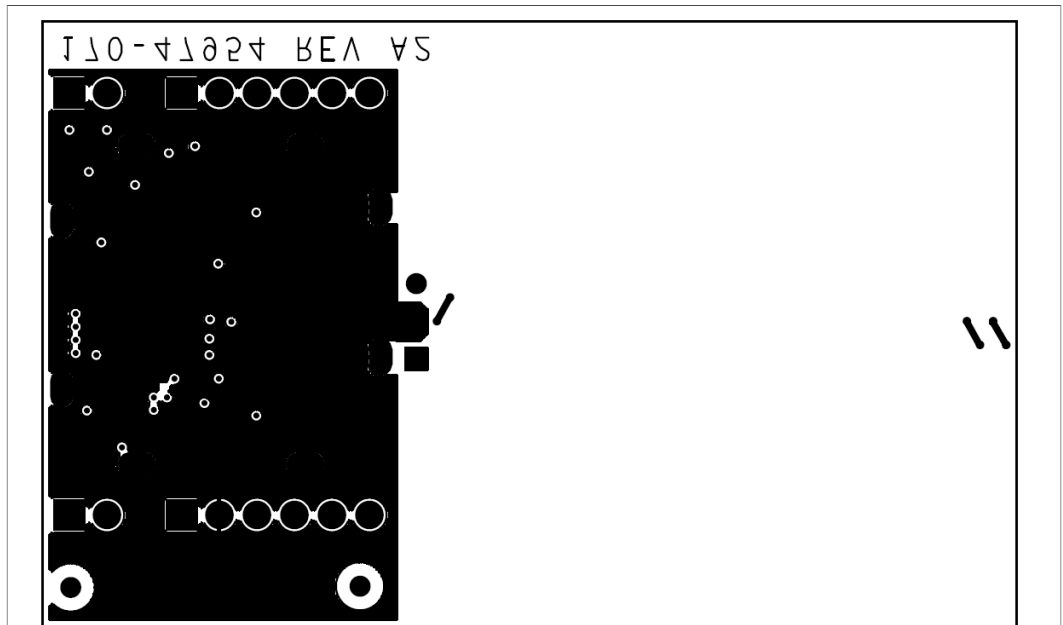

Figure 15. PN7150 NFC controller board layer 4

4.2.6 Top silkscreen layer

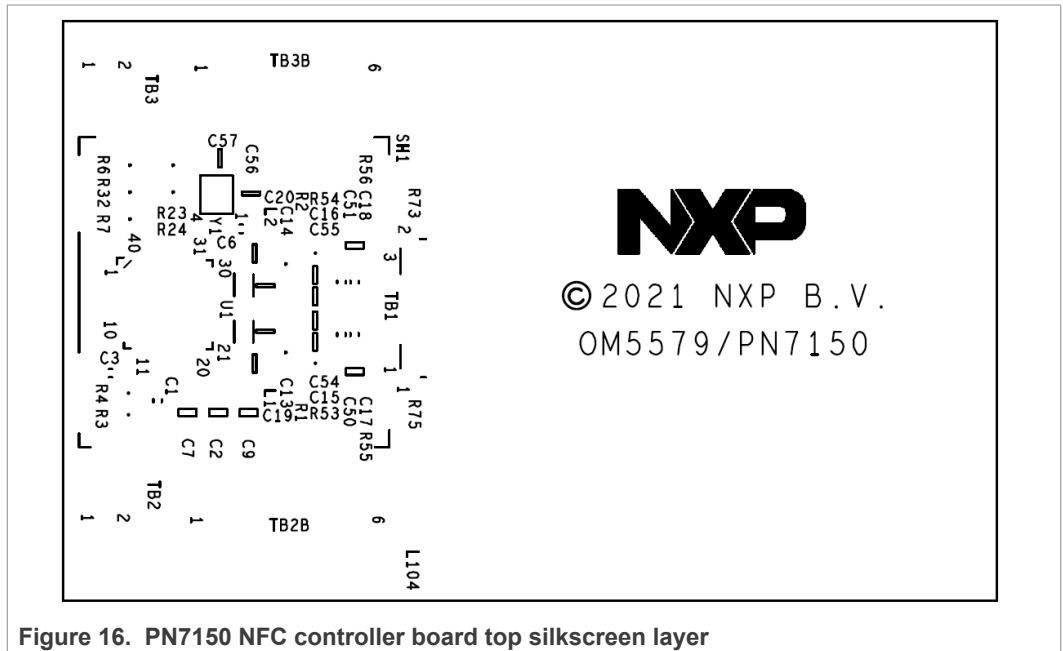

Figure 16. PN7150 NFC controller board top silkscreen layer

5 PN7150 NFC controller board performances

5.1 Settings configuration

Following performance results are obtained applying dedicated configuration to PN7150 optimized for OM5579_PN7150 board characteristics. Those are:

Table 1. RF settings

Transition	Register	Value
RF_CLIF_CFG_INITIATOR	CLIF_AGC_INPUT_REG	90 01 F4 01
RF_CLIF_CFG_TARGET	CLIF_SIGPRO_ADCBCM_THRESHOLD_REG	B0 01 10 00
RF_CLIF_CFG_TARGET	CLIF_ANA_TX_AMPLITUDE_REG	02 00 FF FF
RF_CLIF_CFG_TECHNO_I_TX15693	CLIF_ANA_TX_AMPLITUDE_REG	88 00 FF FF
RF_CLIF_CFG_TECHNO_I_RX15693	CLIF_ANA_RX_REG	22 00
RF_CLIF_CFG_TECHNO_I_RX15693	CLIF_SIGPRO_RM_CONFIG1_REG	50 34 0C 00
RF_CLIF_CFG_BR_106_I_TXA	CLIF_ANA_TX_AMPLITUDE_REG	F8 00 FF FF
RF_CLIF_CFG_BR_106_I_RXA_P	CLIF_SIGPRO_RM_CONFIG1_REG	24 37 0C 00
RF_CLIF_CFG_BR_106_I_RXA_P	CLIF_AGC_CONFIG0_REG	80 86 00 70
RF_CLIF_CFG_BR_106_I_RXA_P	CLIF_ANA_RX_REG	22 00
RF_CLIF_CFG_BR_848_I_RXA	CLIF_SIGPRO_RM_CONFIG1_REG	15 45 0D 00
RF_CLIF_CFG_BR_106_I_RXB	CLIF_ANA_RX_REG	22 00
RF_CLIF_CFG_BR_106_I_RXB	CLIF_SIGPRO_RM_CONFIG1_REG	05 59 0E 00
RF_CLIF_CFG_BR_106_I_TXB	CLIF_ANA_TX_AMPLITUDE_REG	88 00 FF FF
RF_CLIF_CFG_BR_212_I_RXF_P	CLIF_SIGPRO_RM_CONFIG1_REG	05 9F 0C 00
RF_CLIF_CFG_BR_212_I_TXF	CLIF_ANA_TX_AMPLITUDE_REG	88 00 FF FF
RF_CLIF_CFG_I_ACTIVE	CLIF_AGC_CONFIG0_REG	80 86 00 70

Table 2. Clock settings

Register	Value
CLIF_ANA_CLK_MAN_REG	57 33 14 17 00 AA 85 00 80 55 2A 04 00 63 00 00 00

5.2 RF performances

Table 3. Power transfer (Poll mode)

Measured with EMVCo reference PICC

@ 0 cm	@ 1 cm	@ 2 cm	@3 cm
7.6 V	6.7 V	4.3 V	1.2 V

Table 4. Reader/Writer mode performance

Card type	Communication distance (mm)
ISO 15693 UPM RaceTrack	120
NFC Sample Card (NTAG216 – ID1)	80
NFC Sticker (NTAG216 – 40x40)	68
Topaz (35mm Round)	55
Type B (ID1)	45
FeliCa (ID1)	36

Table 5. Peer to Peer mode performances

Vs Samsung Galaxy S7 phone

Communication distance	
Moving phone from far to close	Moving phone from close to far
50	65

Table 6. Card Mode performance

Vs NXP Pegoda Reader

Communication distance (mm)
180

6 Additional information

6.1 Using different antenna

The OM5579/PN7150 kits provide a flexible way of connecting an external RF antenna to be used in place of the onboard one.

On the PN7150 NFC controller board, the dedicated 3 pins connector referenced as TB1 allows connecting your own antenna.

In this case, the onboard antenna must be first disconnected, removing resistors R75 and R73.

Obviously matching circuitry must be adapted as described in related document “AN11755 - PN7150 Antenna Design and Matching Guide” (see [\[8\]](#)).

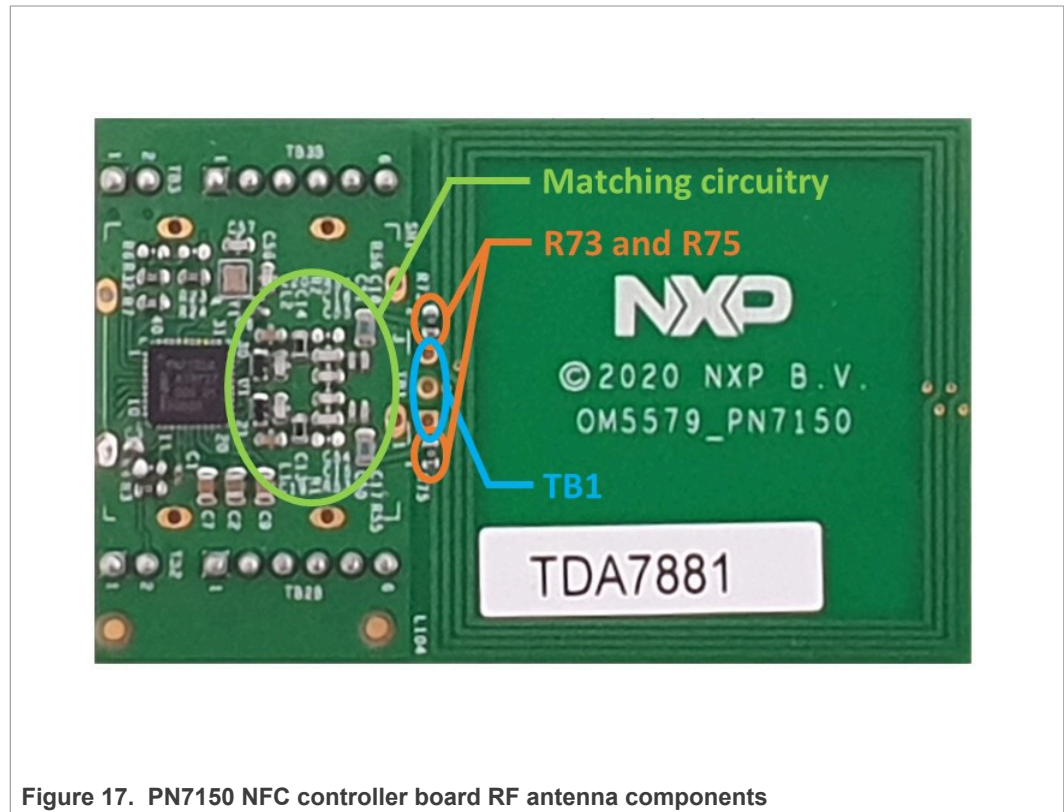

Figure 17. PN7150 NFC controller board RF antenna components

Table 7. PN7150 NFC controller board TB1 connector pinout

TB1	PN7150 signal
#1	ANTENNA 1
#2	GND
#3	ANTENNA 2

6.2 Using different TVDD supply option

The OM5579/PN7150 kits come with Configuration 2: external 5 V used to generate TVDD (refer to “AN11756 – PN7150 Hardware Design Guide” for more details). The 5V being provided by the underlayer SBC platform via the VANT pin of connector TB2.

However, it is still possible to switch to Configuration 1: VBAT used to generate the TVDD. This is done by removing R3 and placing a 0 Ohm resistor in R4 place.

Then related registry setting must be applied accordingly (see “AN11756 – PN7150 hardware design guide” [\[9\]](#)).



Figure 18. PN7150 NFC controller TVDD supply option

6.3 Using different I²C address

The OM5579/PN7150 kits come with default 0x28 (7 bits) I²C address.

However, it is still possible to change it (between 0x28 and 0x2B) by setting of R6, R23, R24 and R32 resistors.

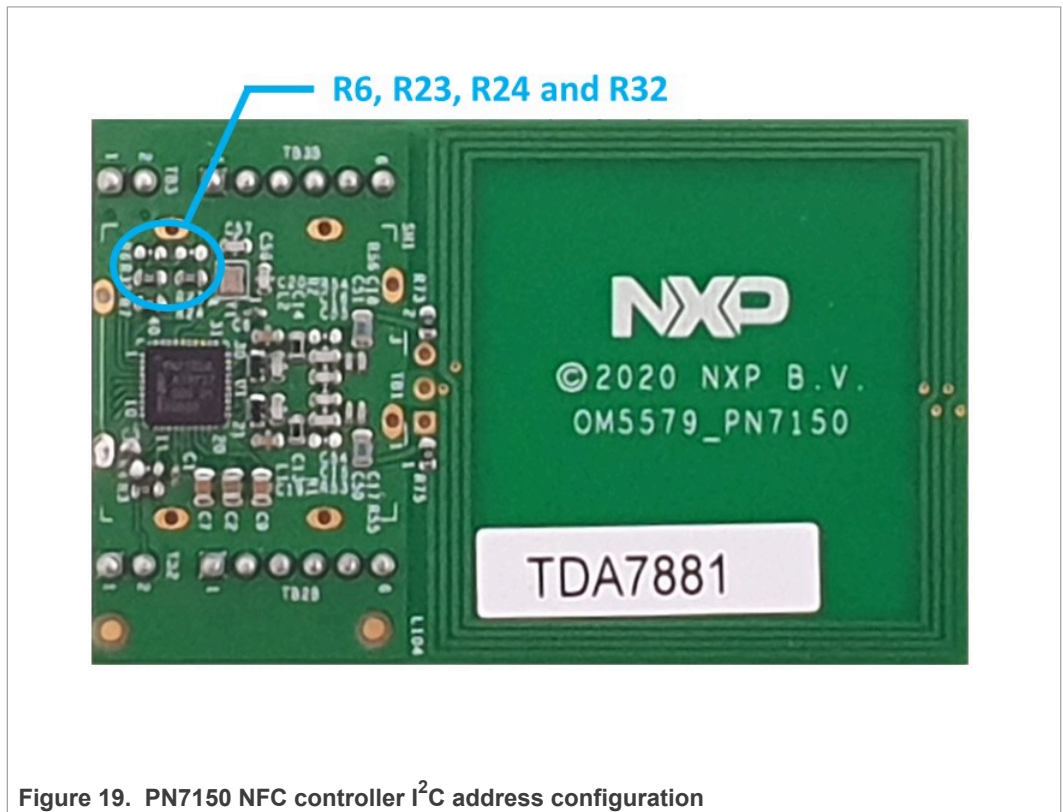

Figure 19. PN7150 NFC controller I²C address configuration

Table 8. I²C address configuration

I2C address	R6	R23	R24	R32
0x28	Open	Open	Short	Short
0x29	Open	Short	Open	Short
0x2A	Short	Open	Short	Open
0x2B	Short	Short	Open	Open

6.4 Using in another system

The OM5579_PN7150 board can be reuse in another system (different from Raspberry Pi or BeagleBone, and not offering Arduino compatible interface).

Indeed, the PN7150 NFC controller board provides all required signals on TB2 and TB3 connectors to interface boards.

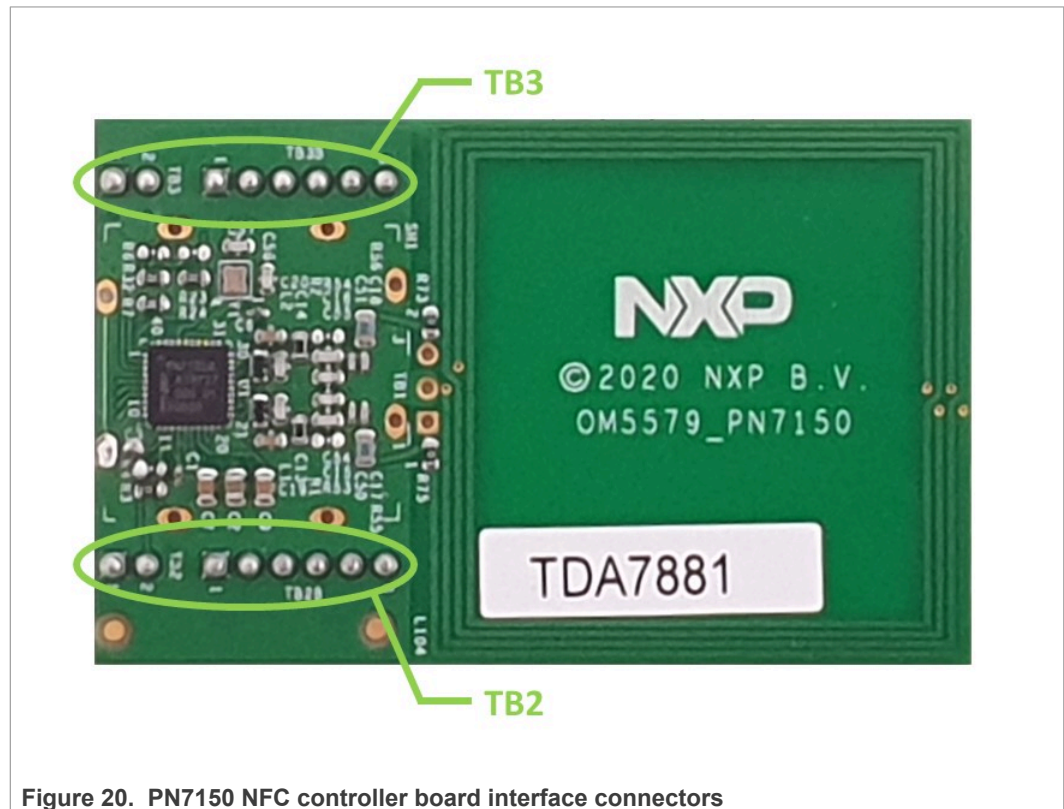

Figure 20. PN7150 NFC controller board interface connectors

Table 9. PN7150 NFC controller board TB2 connector pinout

TB2	PN7150 signal
#1	VBAT/VDD(PAD): 3.3 V supply voltage
#2	VANT: 5 V optional supply voltage
#3	Not connected
#4	GND: ground
#5	IRQ: interrupt request output
#6	VEN: reset pin
#7	Not connected
#8	Not connected

Table 10. PN7150 NFC controller board TB3 connector pinout

TB3	PN7150 signal
#1	I2CSDA: I2C-bus serial data
#2	I2CSCL: I2C-bus serial clock input
#3	Not connected
#4	Not connected
#5	Not connected
#6	Not connected
#7	Not connected
#8	Not connected

7 Radio Equipment Directive

The following information is provided per Article 10.8 of the Radio Equipment Directive 2014/53/EU:

- (a) Frequency bands in which the equipment operates
- (b) The maximum RF power transmitted

PN	RF Technology	(a) Freq Ranges (EU)	(b) Max Transmitted Power
OM5579/PN7150	Near Field Communication	13.56MHz +/- 7kHz	40μW / -44dBi

EUROPEAN DECLARATION OF CONFORMITY (Simplified DoC per Article 10.9 of the Radio Equipment Directive 2014/53/EU).

This apparatus, namely OM5579/PN7150 demokit, conforms to the Radio Equipment Directive 2014/53/EU. The full EU Declaration of Conformity for this apparatus can be found at this location: <https://www.nxp.com/demoboard/OM5579>

8 References

- [1] The Raspberry Pi is a low cost, credit-card sized computer that plugs into a computer monitor or TV, and uses a standard keyboard and mouse. It is a capable little device that enables people of all ages to explore computing, and to learn how to program in languages like Scratch and Python. It is capable of doing everything you would expect a desktop computer to do, from browsing the Internet and playing high-definition video, to making spreadsheets, word-processing, and playing games. For more information visit <https://www.raspberrypi.org/>
- [2] The BeagleBone is a low-cost, community-supported development platform for developers and hobbyists. It is a credit-card-sized Linux computer that connects to the Internet and runs software such as Android 4.0 and Ubuntu. With plenty of I/O and processing power for real-time analysis provided by an Arm processor. For more information visit <http://beagleboard.org/bone>
- [3] The Arduino Uno is a microcontroller board with 14 digital input/output pins (of which 6 can be used as PWM outputs), 6 analog inputs, a 16 MHz quartz crystal, a USB connection, a power jack, an ICSP header and a reset button. For more information visit <https://store.arduino.cc/arduino-uno-rev3>.
- [4] The Freedom-K64F is an ultra-low-cost development platform for Kinetis K64, K63, and K24 MCUs. For more information visit <https://www.nxp.com/design/development-boards/:FRDM-K64F>
- [5] LPCXpresso is a low-cost development platform available from NXP, supporting NXP's Arm-based microcontrollers. The platform is comprised of a simplified Eclipse-based IDE and low-cost target boards which include an attached JTAG debugger. LPCXpresso is an end-to-end solution enabling embedded engineers to develop their applications from initial evaluation to final production. For more information visit <https://www.nxp.com/design/:LPCXPRESSO-BOARDS>
- [6] The OM29110 Interface boards are used to connect NFC's demo boards (e.g. OM5579 related to PN7150 NFC controller) to Single-Board-Computer (like Raspberry Pi, BeagleBone...).
- More details in the related UM10956 - OM29110 NFC's SBC interface boards user manual: <https://www.nxp.com/docs/en/user-guide/UM10956.pdf>
- [7] UM10936 - PN7150 user manual: <https://www.nxp.com/docs/en/user-guide/UM10936.pdf>
- [8] AN11755 - PN7150 antenna design and matching guide: <https://www.nxp.com/docs/en/application-note/AN11755.pdf>
- [9] AN11756 - PN7150 hardware design guide : <https://www.nxp.com/docs/en/application-note/AN11756.pdf>

9 Legal information

9.1 Definitions

Draft — A draft status on a document indicates that the content is still under internal review and subject to formal approval, which may result in modifications or additions. NXP Semiconductors does not give any representations or warranties as to the accuracy or completeness of information included in a draft version of a document and shall have no liability for the consequences of use of such information.

9.2 Disclaimers

Limited warranty and liability — Information in this document is believed to be accurate and reliable. However, NXP Semiconductors does not give any representations or warranties, expressed or implied, as to the accuracy or completeness of such information and shall have no liability for the consequences of use of such information. NXP Semiconductors takes no responsibility for the content in this document if provided by an information source outside of NXP Semiconductors. In no event shall NXP Semiconductors be liable for any indirect, incidental, punitive, special or consequential damages (including - without limitation - lost profits, lost savings, business interruption, costs related to the removal or replacement of any products or rework charges) whether or not such damages are based on tort (including negligence), warranty, breach of contract or any other legal theory. Notwithstanding any damages that customer might incur for any reason whatsoever, NXP Semiconductors' aggregate and cumulative liability towards customer for the products described herein shall be limited in accordance with the Terms and conditions of commercial sale of NXP Semiconductors.

Right to make changes — NXP Semiconductors reserves the right to make changes to information published in this document, including without limitation specifications and product descriptions, at any time and without notice. This document supersedes and replaces all information supplied prior to the publication hereof.

Suitability for use — NXP Semiconductors products are not designed, authorized or warranted to be suitable for use in life support, life-critical or safety-critical systems or equipment, nor in applications where failure or malfunction of an NXP Semiconductors product can reasonably be expected to result in personal injury, death or severe property or environmental damage. NXP Semiconductors and its suppliers accept no liability for inclusion and/or use of NXP Semiconductors products in such equipment or applications and therefore such inclusion and/or use is at the customer's own risk.

Applications — Applications that are described herein for any of these products are for illustrative purposes only. NXP Semiconductors makes no representation or warranty that such applications will be suitable for the specified use without further testing or modification. Customers are responsible for the design and operation of their applications and products using NXP Semiconductors products, and NXP Semiconductors accepts no liability for any assistance with applications or customer product design. It is customer's sole responsibility to determine whether the NXP Semiconductors product is suitable and fit for the customer's applications and products planned, as well as for the planned application and use of customer's third party customer(s). Customers should provide appropriate design and operating safeguards to minimize the risks associated with their applications and products. NXP Semiconductors does not accept any liability related to any default, damage, costs or problem which is based on any weakness or default in the customer's applications or products, or the application or use by customer's third party customer(s). Customer is responsible for doing all necessary testing for the customer's applications and products using NXP Semiconductors products in order to avoid a default of the applications and the products or of the application or use by customer's third party customer(s). NXP does not accept any liability in this respect.

Export control — This document as well as the item(s) described herein may be subject to export control regulations. Export might require a prior authorization from competent authorities.

Evaluation products — This product is provided on an "as is" and "with all faults" basis for evaluation purposes only. NXP Semiconductors, its affiliates and their suppliers expressly disclaim all warranties, whether express, implied or statutory, including but not limited to the implied warranties of non-infringement, merchantability and fitness for a particular purpose. The entire risk as to the quality, or arising out of the use or performance, of this product remains with customer. In no event shall NXP Semiconductors, its affiliates or their suppliers be liable to customer for any special, indirect, consequential, punitive or incidental damages (including without limitation damages for loss of business, business interruption, loss of use, loss of data or information, and the like) arising out of the use of or inability to use the product, whether or not based on tort (including negligence), strict liability, breach of contract, breach of warranty or any other theory, even if advised of the possibility of such damages. Notwithstanding any damages that customer might incur for any reason whatsoever (including without limitation, all damages referenced above and all direct or general damages), the entire liability of NXP Semiconductors, its affiliates and their suppliers and customer's exclusive remedy for all of the foregoing shall be limited to actual damages incurred by customer based on reasonable reliance up to the greater of the amount actually paid by customer for the product or five dollars (US\$5.00). The foregoing limitations, exclusions and disclaimers shall apply to the maximum extent permitted by applicable law, even if any remedy fails of its essential purpose.

Translations — A non-English (translated) version of a document is for reference only. The English version shall prevail in case of any discrepancy between the translated and English versions.

Security — Customer understands that all NXP products may be subject to unidentified or documented vulnerabilities. Customer is responsible for the design and operation of its applications and products throughout their lifecycles to reduce the effect of these vulnerabilities on customer's applications and products. Customer's responsibility also extends to other open and/or proprietary technologies supported by NXP products for use in customer's applications. NXP accepts no liability for any vulnerability. Customer should regularly check security updates from NXP and follow up appropriately. Customer shall select products with security features that best meet rules, regulations, and standards of the intended application and make the ultimate design decisions regarding its products and is solely responsible for compliance with all legal, regulatory, and security related requirements concerning its products, regardless of any information or support that may be provided by NXP. NXP has a Product Security Incident Response Team (PSIRT) (reachable at PSIRT@nxp.com) that manages the investigation, reporting, and solution release to security vulnerabilities of NXP products.

9.3 Licenses

Purchase of NXP ICs with NFC technology

Purchase of an NXP Semiconductors IC that complies with one of the Near Field Communication (NFC) standards ISO/IEC 18092 and ISO/IEC 21481 does not convey an implied license under any patent right infringed by implementation of any of those standards. Purchase of NXP Semiconductors IC does not include a license to any NXP patent (or other IP right) covering combinations of those products with other products, whether hardware or software.

9.4 Trademarks

Notice: All referenced brands, product names, service names and trademarks are the property of their respective owners.

I²C-bus — logo is a trademark of NXP B.V.

NTAG — is a trademark of NXP B.V.

Kinetis — is a trademark of NXP B.V.

NXP — wordmark and logo are trademarks of NXP B.V.

AMBA, Arm, Arm7, Arm7TDMI, Arm9, Arm11, Artisan, big.LITTLE, Cordio, CoreLink, CoreSight, Cortex, DesignStart, DynamIQ, Jazelle, Keil, Mali, Mbed, Mbed Enabled, NEON, POP, RealView, SecurCore,

Socrates, Thumb, TrustZone, ULINK, ULINK2, ULINK-ME, ULINK-PLUS, ULINKpro, μ Vision, Versatile — are trademarks or registered trademarks of Arm Limited (or its subsidiaries) in the US and/or elsewhere. The related technology may be protected by any or all of patents, copyrights, designs and trade secrets. All rights reserved.

FeliCa — is a trademark of Sony Corporation.

Tables

Tab. 1.	RF settings	13	Tab. 7.	PN7150 NFC controller board TB1 connector pinout	15
Tab. 2.	Clock settings	13	Tab. 8.	I2C address configuration	17
Tab. 3.	Power transfer (Poll mode)	13	Tab. 9.	PN7150 NFC controller board TB2 connector pinout	18
Tab. 4.	Reader/Writer mode performance	14	Tab. 10.	PN7150 NFC controller board TB3 connector pinout	19
Tab. 5.	Peer to Peer mode performances	14			
Tab. 6.	Card Mode performance	14			

Figures

Fig. 1.	OM5579/PN7150RPI kit overview	4	Fig. 12.	PN7150 NFC controller board layer 1	10
Fig. 2.	OM5579/PN7150BBB kit overview	4	Fig. 13.	PN7150 NFC controller board layer 2	10
Fig. 3.	OM5579/PN7150ARD kit overview	4	Fig. 14.	PN7150 NFC controller board layer 3	11
Fig. 4.	OM5579_PN7150 NFC controller board	5	Fig. 15.	PN7150 NFC controller board layer 4	11
Fig. 5.	OM29110RPI-B Raspberry Pi Interface board	6	Fig. 16.	PN7150 NFC controller board top silkscreen layer	12
Fig. 6.	OM29110BBB-B BeagleBone interface board	6	Fig. 17.	PN7150 NFC controller board RF antenna components	15
Fig. 7.	OM29110ARD-B Arduino interface board	7	Fig. 18.	PN7150 NFC controller TVDD supply option	16
Fig. 8.	NFC sample card	7	Fig. 19.	PN7150 NFC controller I2C address configuration	17
Fig. 9.	PN7150 NFC controller board schematics	8	Fig. 20.	PN7150 NFC controller board interface connectors	18
Fig. 10.	PN7150 NFC controller board top components layers	9			
Fig. 11.	PN7150 NFC controller board bottom components layers	9			