



TAOGLAS®



Datasheet

Barracuda – 5.5dBi Omnidirectional Antenna Covering 2.4-6GHz 5G/4G and Public Safety Bands

Part No:
OMB.445.05F21

Features:

- Omnidirectional Radiation Pattern
- Robust Design for all Demanding Application
- IP65 Waterproof
- Length: 270mm
- Weight: 250g
- Connector: N-type Female
- Wall/Pole Mount Bracket Included
- RoHS & Reach Compliant

1. Introduction	3
2. Specifications	4
3. Antenna Characteristics	6
4. Radiation Patterns	9
5. Mechanical Drawing	14
6. Packaging	15
7. Installation	16
<hr/>	
Changelog	17

Taoglas makes no warranties based on the accuracy or completeness of the contents of this document and reserves the right to make changes to specifications and product descriptions at any time without notice. Taoglas reserves all rights to this information contained herein. Reproduction, use or disclosure to third parties without express permission is strictly prohibited.



1. Introduction



The Taoglas Barracuda OMB.445 is a robust, cost-effective outdoor antenna designed to provide long-distance coverage for 4G and sub 6GHz 5G bands, spanning 2 – 6GHz. With incredible efficiency of up to 88%, the high omnidirectional gain ensures consistent and reliable reception and transmission making the OMB.455 perfect for private LTE or CBRS networks or Public Safety applications.

The UV-resistant fiberglass radome ensures that the antenna can be used for many years of outdoor use without any degradation of appearance or mechanical specifications. The radome sits in a rugged bracket that makes this antenna suitable to be mounted by either pole-mount or and wall-mounting options.

The OMB.455 ships with an industry-standard N-Type connector but other connectors are available subject to MOQ and NRE. Taoglas can also offer a customized cable assembly to help with your installation. Check out our Cable Builder [here](#).

For more information on the OMB.455 or any of Taoglas Barracuda series of omnidirectional antennas, contact your regional Taoglas customer support team.

2. Specifications

Electric								
Band	Frequency (MHz)	Efficiency (%)	Average Gain (dB)	Peak Gain (dBi)	Impedance	Max Input Power	Polarization	Radiation Pattern
4G/3G Band 7,30,38,40,41	2300~2690	59	-2.3	4.1	50 Ω	100W	Vertical	Omni-directional
5G/4G Band 22,42,78	3300~3800	86	-0.6	6.1				
5G/4G Band 22,42,43,48,77,78,79	3200~5000	88	-0.5	7.2				
Greater than 5GHz	5150~5925	86	-0.6	6.8				
Antenna Type	Collinear							
Vertical Beam-width	25 Deg							
Horizontal Beam-width	360 Deg							
Antenna Design	Dipole Array							

Mechanical	
Length	270mm
Bracket Dimension	70*35mm
Radome Diameter	24mm
Antenna Weight (G.W)	250g
Mounting Accessories (G.W)	50g
Application	Indoor/Outdoor
Radome Material	White Fiberglass
Internal Material	Copper
Connector	N Type Female
Base Material	Aluminum
Mount Style	Pole Mount(32mm~48mm)/Wall Mount
Mounting	Stainless Steel
Wind Resistance	>150mph(>241km/h)
Waterproof	IP65
Environmental	
Storage Temperature	-20°C to +80°C
Operating Temperature	-20°C to +60°C
Operating Humidity	10%~80% non-condensing
Storage Humidity	5%~80% non-condensing

5G/4G Bands			
Band Number	5G NR / FR1 / LTE / LTE-Advanced / WCDMA / HSPA / HSPA+ / TD-SCDMA		
	Uplink	Downlink	Covered
1	UL: 1920 to 1980	DL: 2110 to 2170	✘
4	UL: 1710 to 1755	DL: 2110 to 2155	✓
7	UL: 2500 to 2570	DL: 2620 to 2690	✓
22	UL: 3410 to 3490	DL: 3510 to 3590	✓
23	UL: 2000 to 2020	DL: 2180 to 2200	✓
30	UL: 2305 to 2315	DL: 2350 to 2360	✓
38		2570 to 2620	✓
40		2300 to 2400	✓
41		2496 to 2690	✓
42		3400 to 3600	✓
43		3600 to 3800	✓
48		3550 to 3700	✓
66	UL: 1710-1780	DL: 2110-2200	✘
77		3300 to 4200	✓
78		3300 to 3800	✓
79		4400 to 5000	✓

3. Antenna Characteristics

3.1 Return Loss

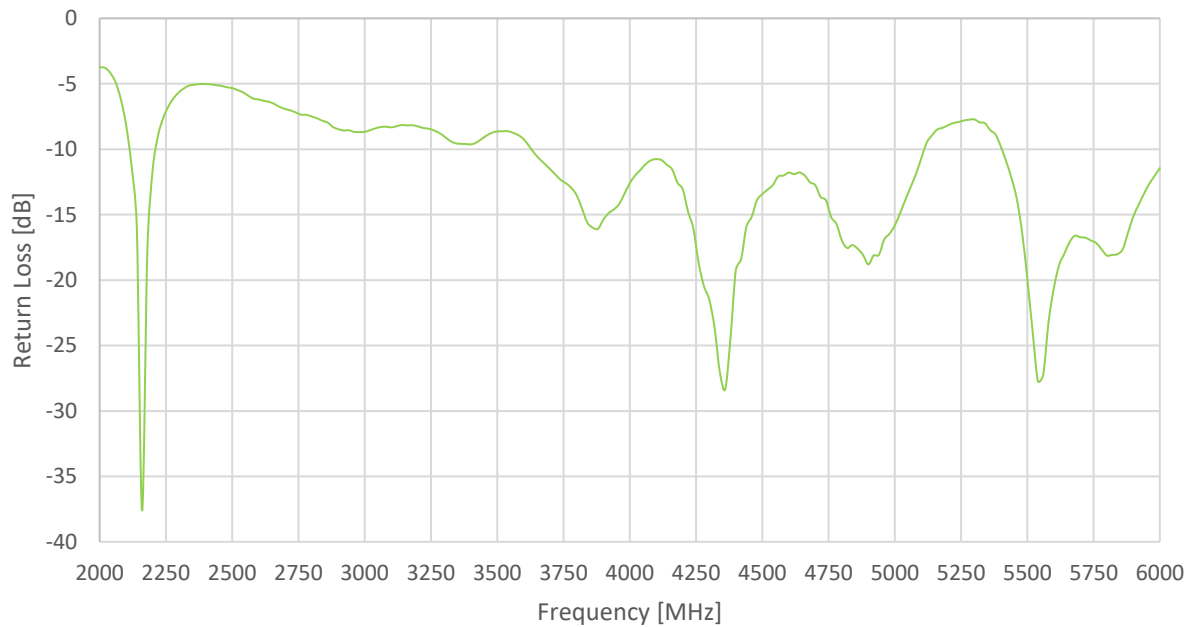

3.2 VSWR

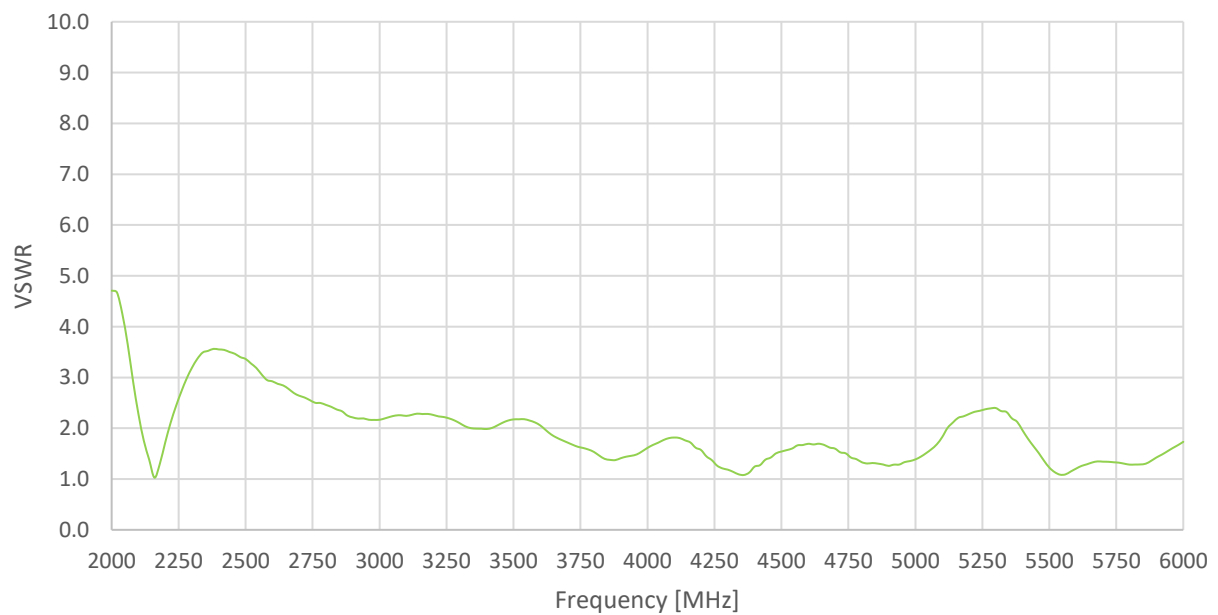

3.3 Efficiency

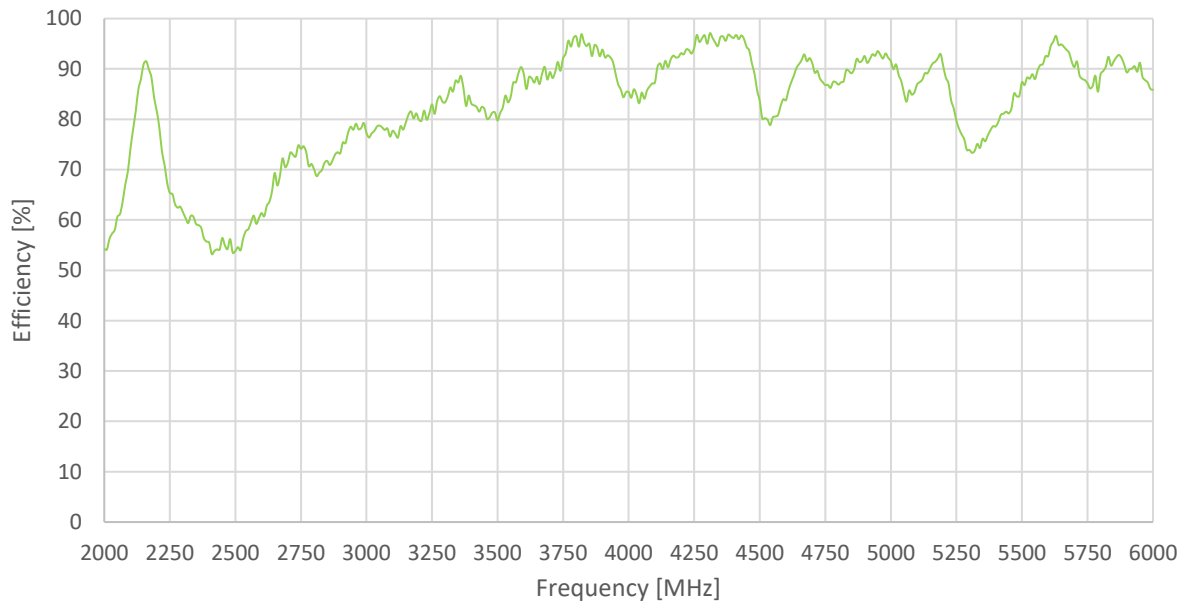

3.4 Peak Gain

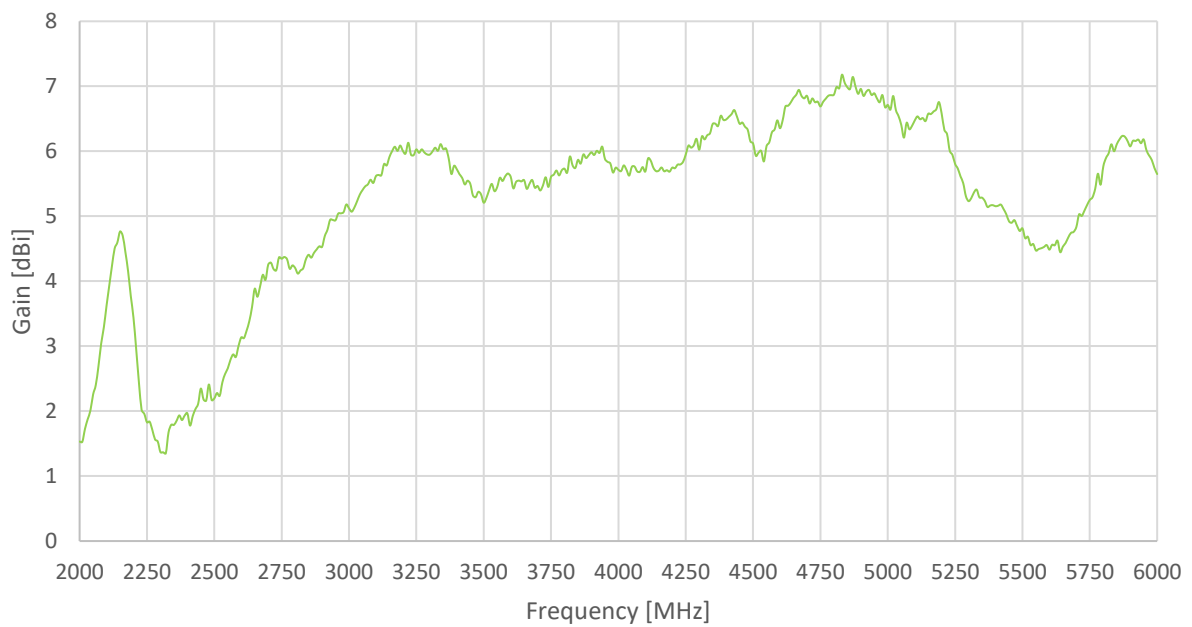

3.5 Average Gain

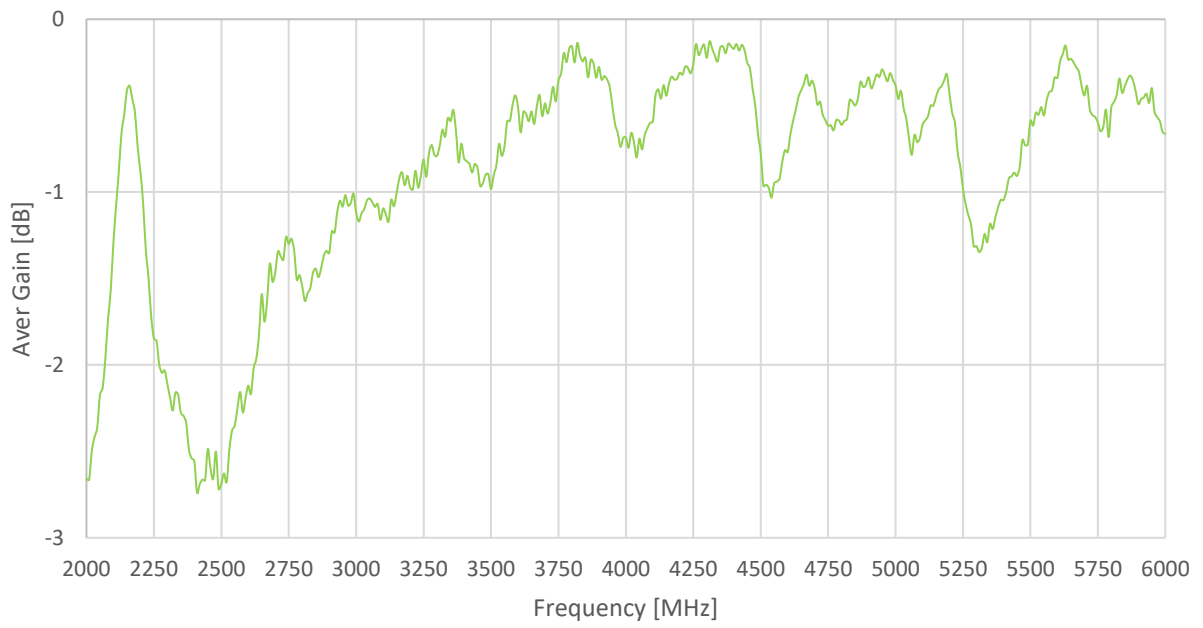

4. Radiation Patterns

4.1 Test Setup



Chamber Set-up



VNA Set-up

4.2 2400MHz 3D and 2D Radiation Patterns

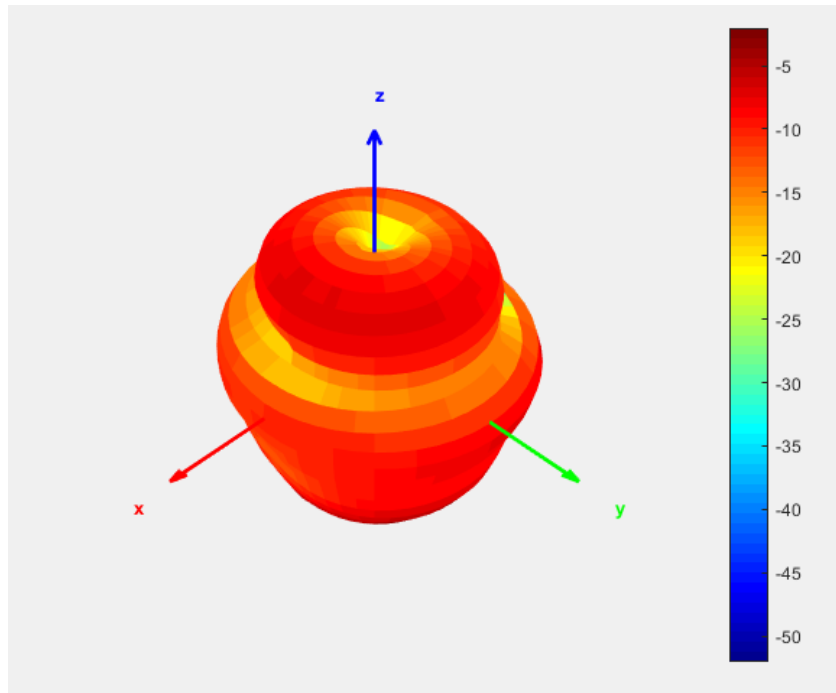

XY Plane

XZ Plane

YZ Plane

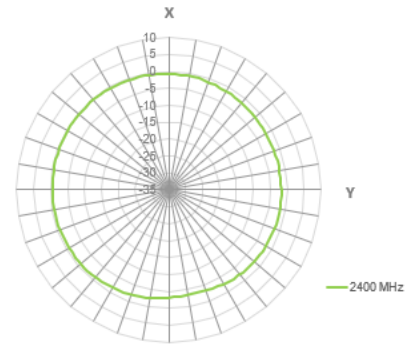
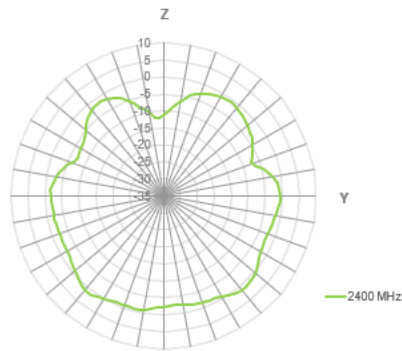
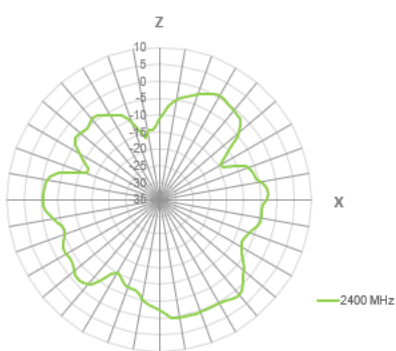

3500MHz

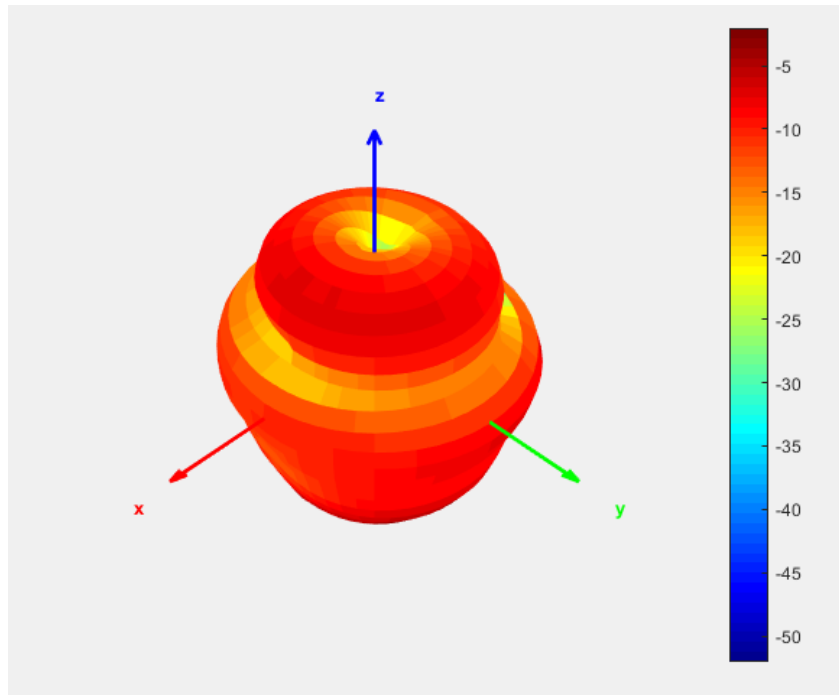

XY Plane

XZ Plane

YZ Plane

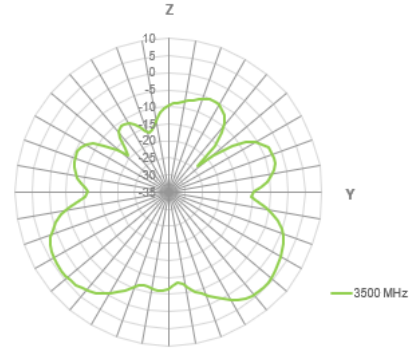
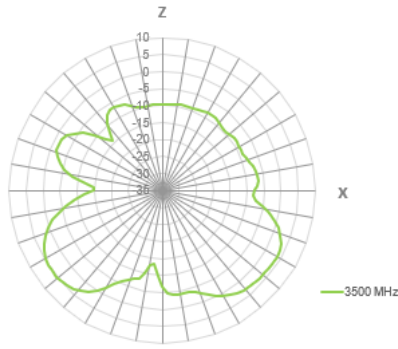
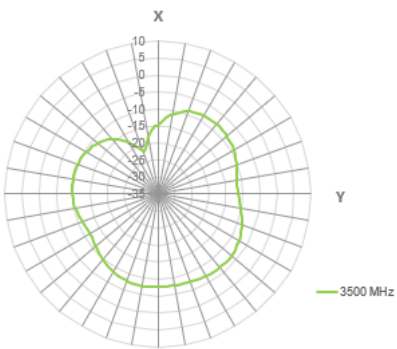

4400MHz

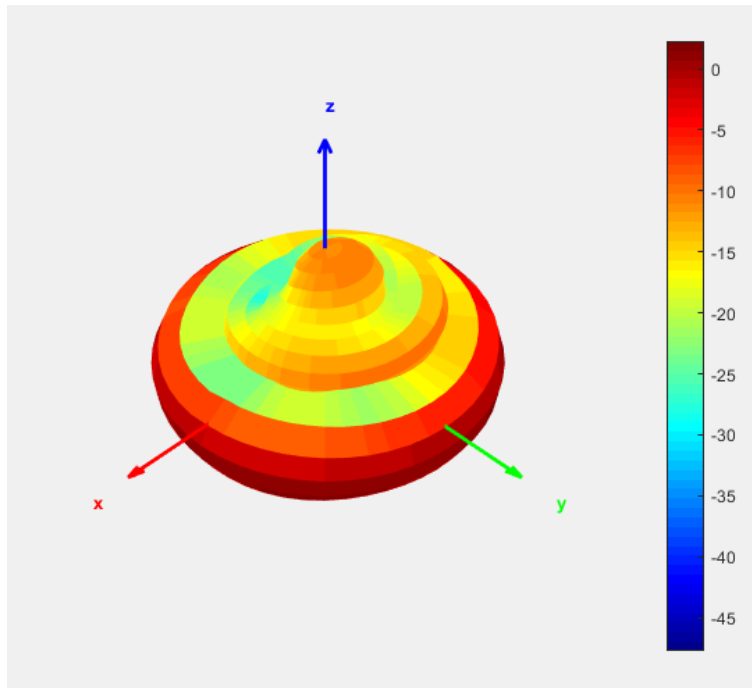

XY Plane

XZ Plane

YZ Plane

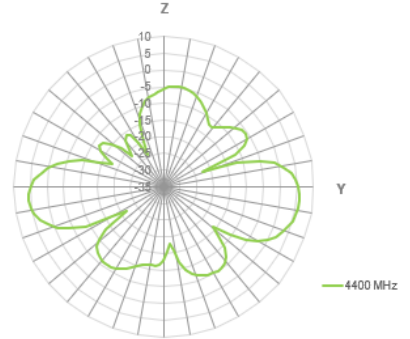
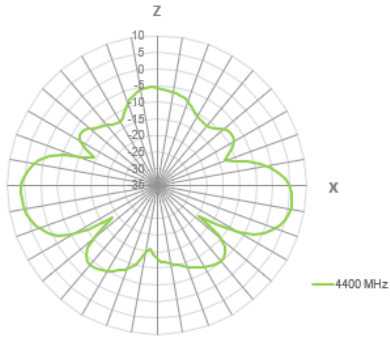
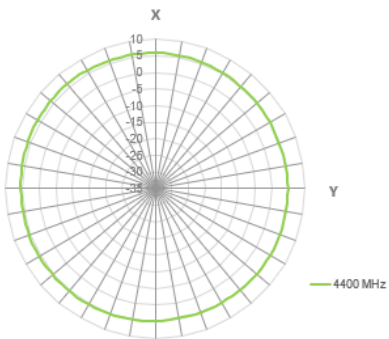

5500MHz

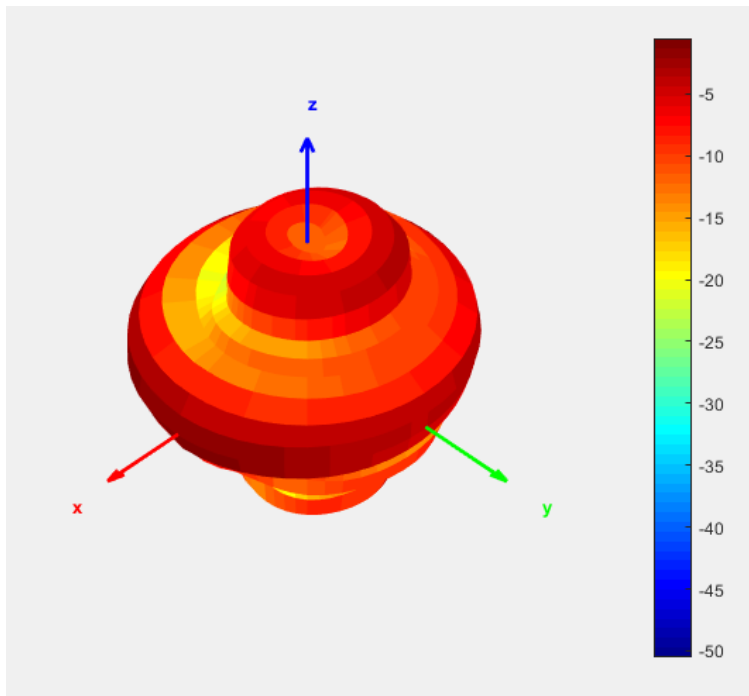

XY Plane

XZ Plane

YZ Plane

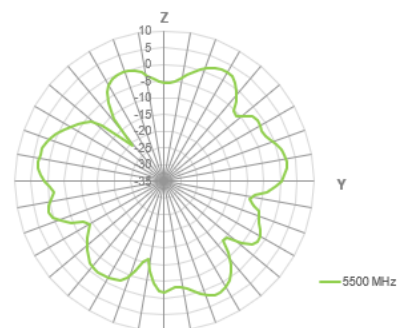
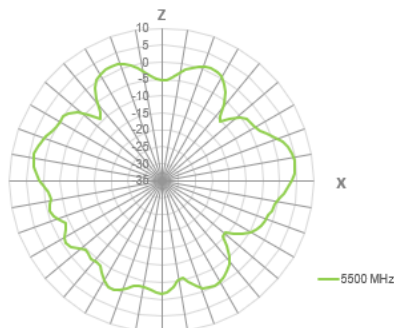
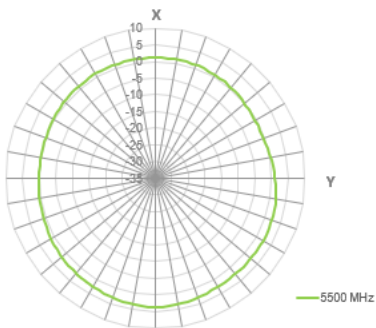

5. Mechanical Drawing (Units: mm)

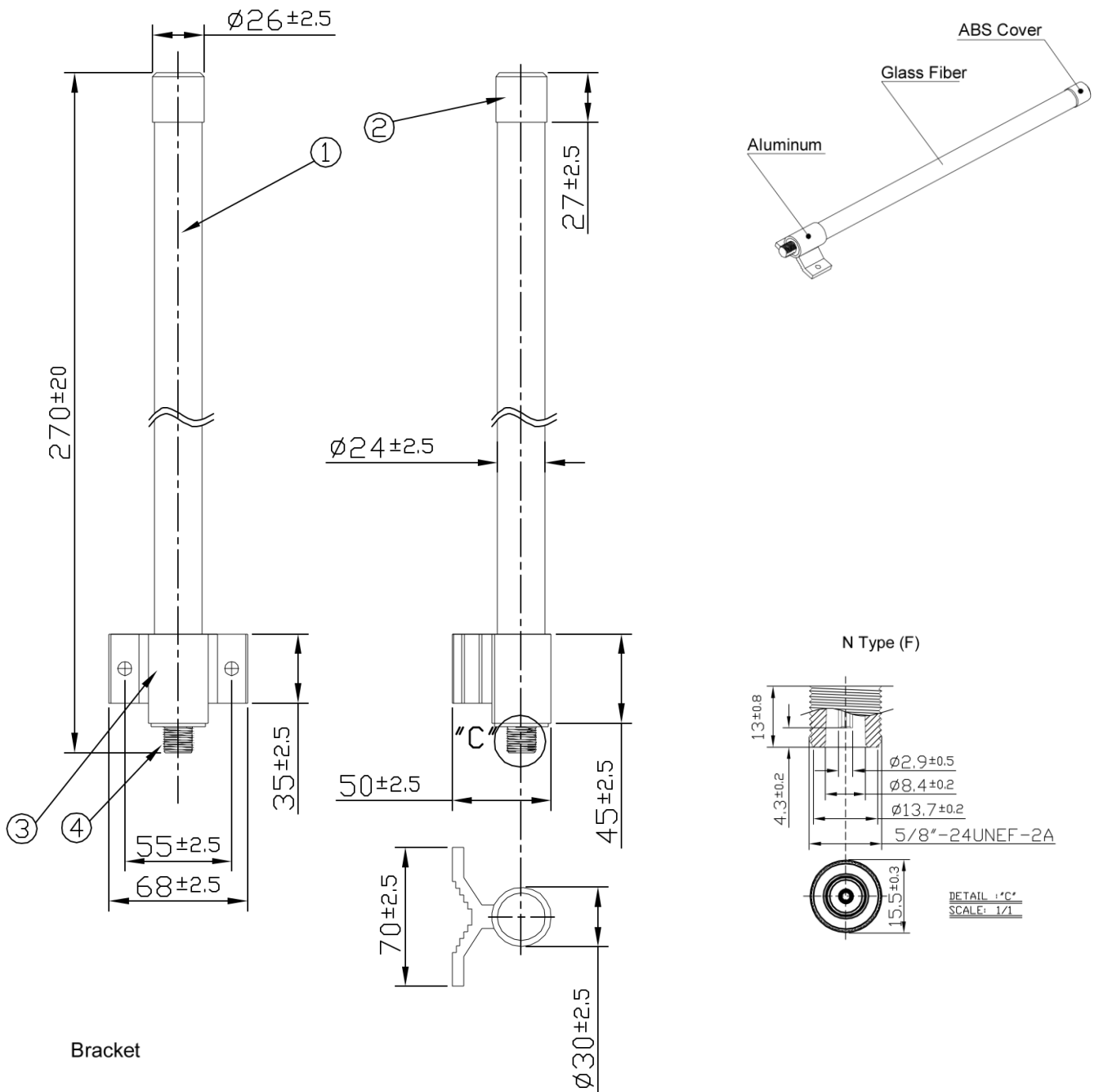

	Name	Material	Finish	QTY
1	OMB.445 Antenna	Glass Fiber	White	1
2	Cover	ABS	Silver	1
3	Holder	Aluminum	Silver	1
4	N Type(F)	Brass	Ni Plated	1
5	M6 U Type Screw	Stainless Steel	Silver	1
6	M6 Washer	Stainless Steel	Silver	2
7	M6 Nut	Stainless Steel	Silver	2

6. Packaging

1 OMB.445.05F21 per tube
 Tube Dimensions - $\varnothing 80\text{mm} \times \text{Height } 470\text{mm}$
 Total Weight - 446.5g

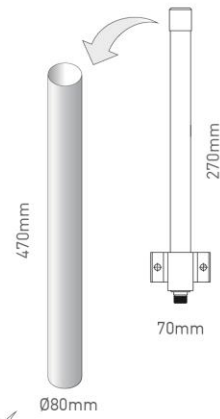

10 tubes per carton
 10 pcs OMB.445.05F21 per carton
 Carton Dimensions - $490 \times 405 \times 185\text{mm}$
 Weight - 5.288kg

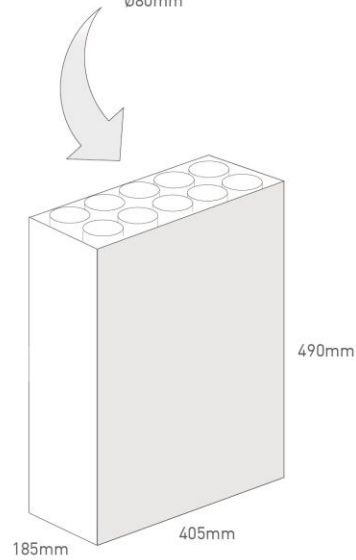

Pallet Dimensions $1200\text{mm} \times 1000\text{mm} \times 1495\text{mm}$
 28 Cartons per Pallet
 4 Cartons per layer
 7 Layers

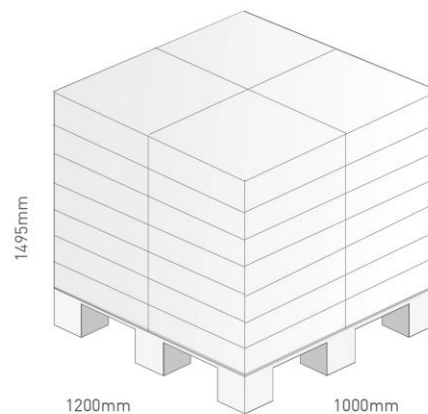

7. Installation

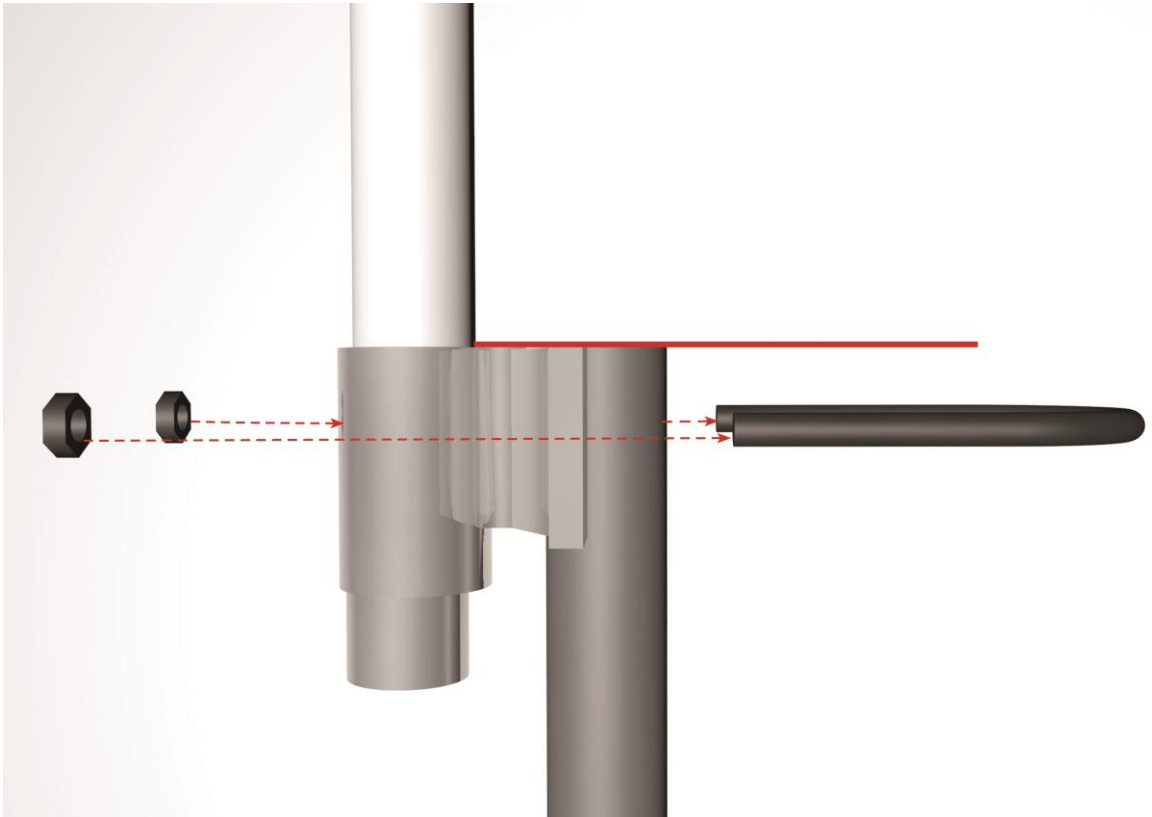

Mounting Recommendations:

For optimum cellulat performance when mounting the OMB.455 onto a metal pole, please ensure that the base of the antenna / top of the bracket is mounted above the top of the pole as per the red line above. Failure to do so may impede performance of the antenna.

Changelog for the datasheet

SPE-13-8-042 - OMB.445.05F21

Revision: E (Current Version)

Date:	2021-07-23
Changes:	Full datasheet update and rebranded to cover 5GHz band
Changes Made by:	Gary West

Previous Revisions

Revision: D

Date:	2018-03-27
Changes:	Amended Installation
Changes Made by:	Jack Conroy

Revision: C

Date:	2018-03-16
Changes:	Added Installation Guide
Changes Made by:	Jack Conroy

Revision: B

Date:	2015-08-21
Changes:	added note on gain
Changes Made by:	Aine Doyle

Revision: A (Original First Release)

Date:	2021-05-17
Notes:	
Author:	SS