

Specification

- Part No. : **OMB.6912.03F21**
- Description : 4G 698-960Mhz and 1710-2700MHz
4.5 dBi Omnidirectional Outdoor Antenna
with N Type Female Connector, U-Bolt
- Features : Omni-Directional Radiation Pattern
4.5 dBi Peak gain
Covers all 4G/3G/2G bands
Robust design for all weather operation
IP65 waterproof
320mm in length, 150g weight
N Type Female connector
Mounting bracket Included
RoHS compliant



1. Introduction

The OMB.6912.03F21 is a 4G fiberglass omnidirectional outdoor antenna, operating in the worldwide 4G 698-960 and 1710-2700MHz bands and has 4.5 dBi maximum gain. The collinear dipole array antenna is designed especially for outdoor applications connecting via 4G routers and modules. Its compact dimensions of 320mm in length and 70mm diameter allow it to be mounted conveniently and unobtrusively in any location, compared to traditional fiberglass omni antennas which are twice the size.

The omnidirectional antenna radiates uniformly in the azimuth providing long distance coverage, thus minimizing the number of nodes needed for a radio network.

The UV resistant fiberglass housing enables this OMB series antenna to be used in harsh weather environments, making it more robust and safer than traditional whip antennas. The main band of operation is between 698MHz to 2170MHz; however, it can also be used for shorter range 2600MHz applications.

The antenna can be mounted on a wall via the convenient pre-installed mounting bracket or on a pole with the additional supplied U-bolt. An industry standard N-type Female connector is used. The connector can be customized upon request subject to MOQ. Contact your regional Taoglas sales office for details.

2. Specification

Electrical Characteristics					
Band Number		Frequency (MHz)	Efficiency (%)	Average Gain (dB)	Peak Gain (dBi)
1	Uplink	1920-1980	30	-1.5	-0.8
	Downlink	2110-2170	75	-1.3	1.4
2	Uplink	1850-1910	32	-1.7	-0.3
	Downlink	1930-1990	31	-1.4	-0.5
3	Uplink	1710-1785	47	-1.6	0.4
	Downlink	1805 – 1880	36	-1.6	0.1
4	Uplink	1710-1755	49	-1.7	0.4
	Downlink	2110 – 2155	75	-1.3	1.6
5	Uplink	824-849	53	-1.8	1.7
	Downlink	869 – 894	58	-2.7	2.6
6	Uplink	875-885	57	-2.7	2.5
	Downlink	830-840	55	-1.7	1.8
7	Uplink	2500 – 2570	67	-1.5	3.4
	Downlink	2620 – 2690	60	-1.9	2.9
8	Uplink	880 – 915	56	-3.2	2.6
	Downlink	925 – 960	57	-3.6	2.2
9	Uplink	1749.9 – 1784.9	45	-1.6	0.4
	Downlink	1844.9 – 1879.9	34	-1.6	-0.1
10	Uplink	1710 - 1770	48	-1.7	0.4
	Downlink	2110-2170	75	-1.3	1.4
11	Uplink	1427.9 – 1447.9	41	-6.2	-0.9
	Downlink	1475.9 – 1495.9	41	-3.8	-0.5
12	Uplink	699 – 716	49	-2.1	-0.5
	Downlink	729 – 746	50	-1.5	-0.4
13	Uplink	777 – 787	43	-1.3	0.1
	Downlink	746 – 756	48	-1.4	-0.4
14	Uplink	788 – 798	43	-1.2	0.5
	Downlink	758 – 768	45	-1.4	-0.3
17	Uplink	704 – 716	49	-2.1	-0.5
	Downlink	734 – 746	50	-1.5	-0.4
18	Uplink	815 – 830	51	-1.3	1.5
	Downlink	860 – 875	58	-2.5	2.4
19	Uplink	830 – 845	55	-1.9	1.8
	Downlink	875 – 890	57	-2.7	2.6

20	Uplink	832 – 862	56	-2	2
	Downlink	791 – 821	46	-1.2	1
21	Uplink	1447.9 – 1462.9	42	-5.2	-0.5
	Downlink	1495.9 – 1510.9	42	-3.7	-0.2
22	Uplink	3410 – 3490	76	-3.2	2.2
	Downlink	3510 – 3590	81	-2.5	3.3
23	Uplink	2000-2020	49	-1	0.3
	Downlink	2180-2200	75	-1.3	1.1
24	Uplink	1626.5-1660.5	52	-1.7	0.9
	Downlink	1525-1559	43	-1.7	0.2
25	Uplink	1850 – 1915	32	-1.7	-0.4
	Downlink	1930 – 1995	31	-1.4	-0.5
26	Uplink	814 – 849	53	-1.6	1.7
	Downlink	859 – 894	58	-2.6	2.5
27	Uplink	807 – 824	47	-1.2	1.2
	Downlink	852 – 869	58	-2.4	2.3
28	Uplink	703 – 748	49	-1.8	-0.4
	Downlink	758 – 803	44	-1.3	0.1
29	Downlink	717 – 728	50	-1.8	-0.4
30	Uplink	2305 – 2315	71	-1.8	1.9
	Downlink	2350 – 2360	72	-1.4	2.6
32	Downlink	1452 – 1496	41	-4.4	-0.5
33		1900-1920	31	-1.7	-0.9
34		2010-2025	53	-0.8	0.2
35		1850-1910	32	-1.7	-0.3
36		1930-1990	31	-1.4	-0.5
37		1910-1930	30	-1.5	-1.3
38		2570 – 2620	58	-1.6	3
39		1880 – 1920	31	-1.7	-0.7
40		2300 – 2400	72	-1.6	2.5
41		2496 – 2690	63	-1.7	3.1
42		3400 – 3600	78	-2.8	2.7

Electrical	
Antenna Type	Collinear Dipole Array
Polarization	Vertical (Linear)
Impedance	50 ohms
Max Input Power	150 watts
Radiation	Omnidirectional
Vertical Beamwidth	698-960MHz: 59 Deg 1710-2170 MHz: 37 Deg
Horizontal Beamwidth	360 Deg
Mechanical	
Length	320mm(Max)
Bracket Dimension	70 x 53mm(Max)
Antenna Diameter	Ø26 mm
Antenna Weight	150g
Mounting Accessories Weight	35g
Application	Indoor/Outdoor
Radome Material	White Fiberglass
Bracket Material	Aluminum
Mount Style	Pole Mount/Wall Mount
Mount Hardware Material	Stainless Steel
Wind Resistance	>150mph (>241km/h)
Internal Material	Copper
Connector	N Type Female
Waterproof	IP65
Flammability Rating	UL-94 HB
Environmental	
Storage Temperature	-40°C to +80°C
Operating Temperature	-40°C to +60°C
Operating Humidity	10%~90% non-condensing
Storage Humidity	5%~80% non-condensing

LTE BANDS			
Band Number	LTE / LTE-Advanced / WCDMA / HSPA / HSPA+ / TD-SCDMA		
	Uplink	Downlink	Covered
1	UL: 1920 to 1980	DL: 2110 to 2170	✓
2	UL: 1850 to 1910	DL: 1930 to 1990	✓
3	UL: 1710 to 1785	DL: 1805 to 1880	✓
4	UL: 1710 to 1755	DL: 2110 to 2155	✓
5	UL: 824 to 849	DL: 869 to 894	✓
7	UL: 2500 to 2570	DL: 2620 to 2690	✓
8	UL: 880 to 915	DL: 925 to 960	✓
9	UL: 1749.9 to 1784.9	DL: 1844.9 to 1879.9	✓
11	UL: 1427.9 to 1447.9	DL: 1475.9 to 1495.9	✓
12	UL: 699 to 716	DL: 729 to 746	✓
13	UL: 777 to 787	DL: 746 to 756	✓
14	UL: 788 to 798	DL: 758 to 768	✓
17	UL: 704 to 716	DL: 734 to 746 (LTE only)	✓
18	UL: 815 to 830	DL: 860 to 875 (LTE only)	✓
19	UL: 830 to 845	DL: 875 to 890	✓
20	UL: 832 to 862	DL: 791 to 821	✓
21	UL: 1447.9 to 1462.9	DL: 1495.9 to 1510.9	✓
22	UL: 3410 to 3490	DL: 3510 to 3590	✓
23	UL: 2000 to 2020	DL: 2180 to 2200 (LTE only)	✓
24	UL: 1625.5 to 1660.5	DL: 1525 to 1559 (LTE only)	✓
25	UL: 1850 to 1915	DL: 1930 to 1995	✓
26	UL: 814 to 849	DL: 859 to 894	✓
27	UL: 807 to 824	DL: 852 to 869 (LTE only)	✓
28	UL: 703 to 748	DL: 758 to 803 (LTE only)	✓
29	UL: -	DL: 717 to 728 (LTE only)	✓
30	UL: 2305 to 2315	DL: 2350 to 2360 (LTE only)	✓
31	UL: 452.5 to 457.5	DL: 462.5 to 467.5 (LTE only)	✓
32	UL: -	DL: 1452 - 1496	✓
35		1850 to 1910	✓
38		2570 to 2620	✓
39		1880 to 1920	✓
40		2300 to 2400	✓
41		2496 to 2690	✓
42		3400 to 3600	✓
43		3600 to 3800	✓

*Covered bands represent an efficiency greater than 20%

3 Antenna Characteristics

3.1. S11

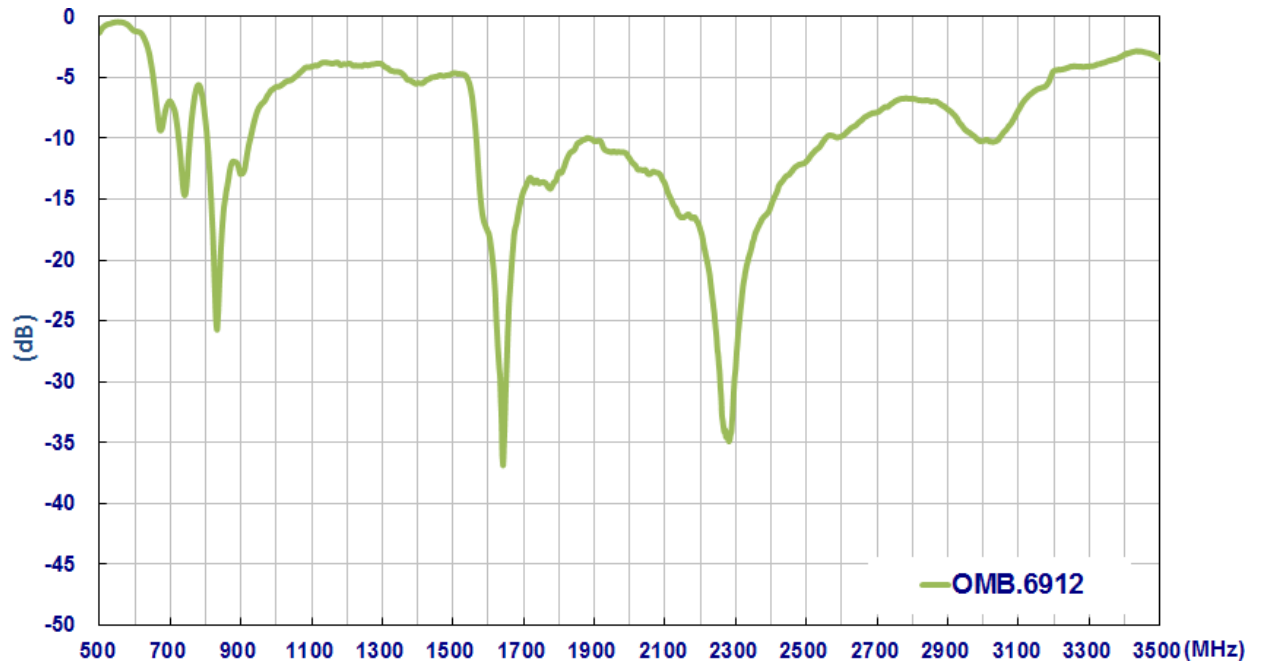

3.2 Efficiency

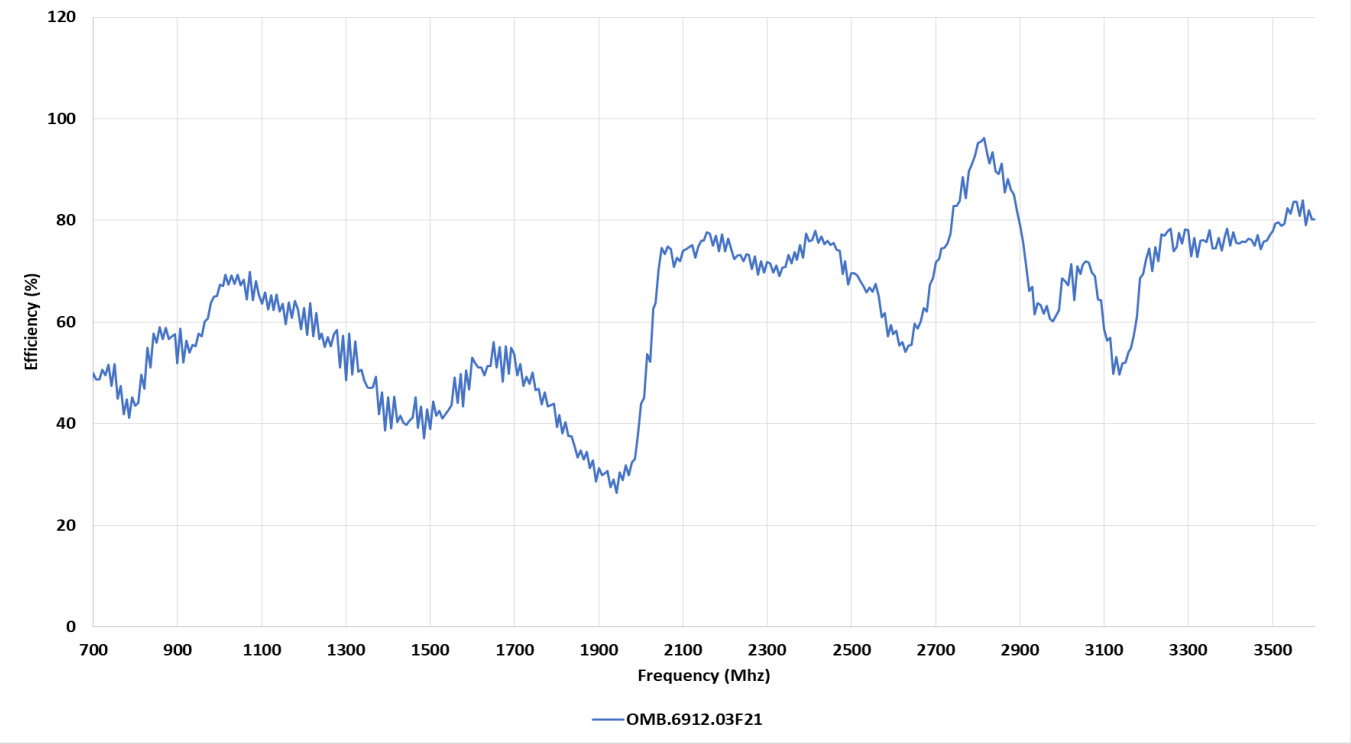

3.3 Average Gain

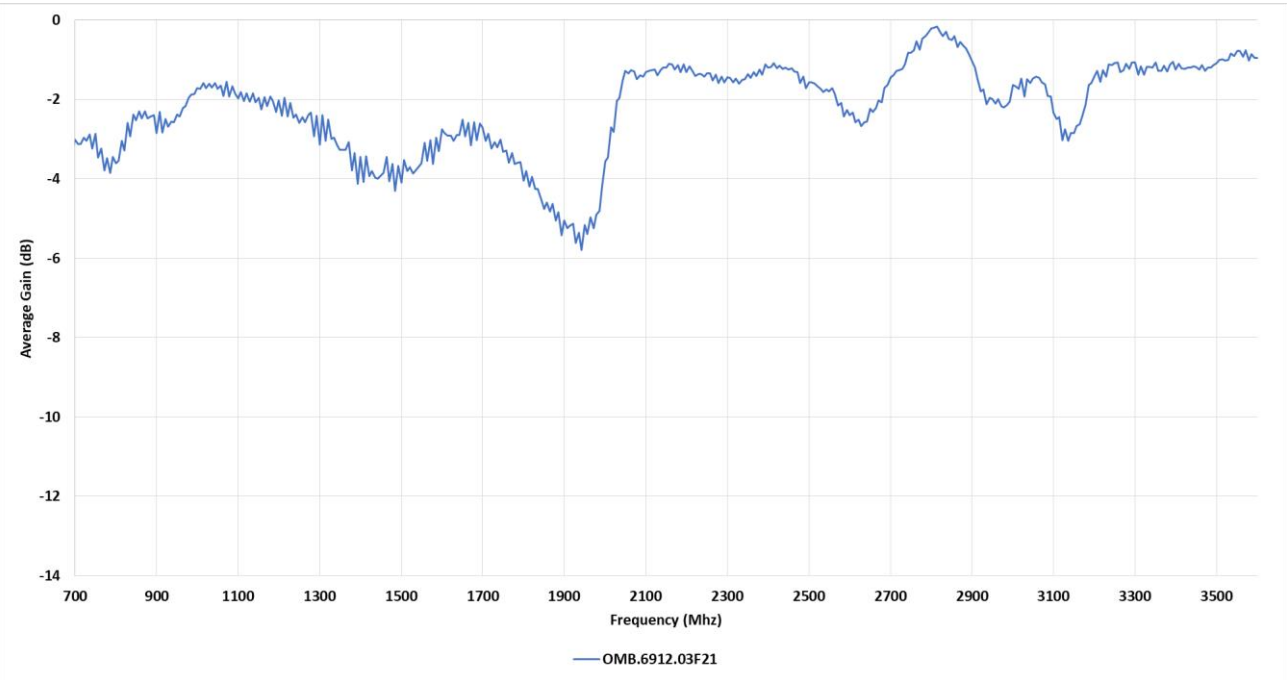

3.4 Peak Gain

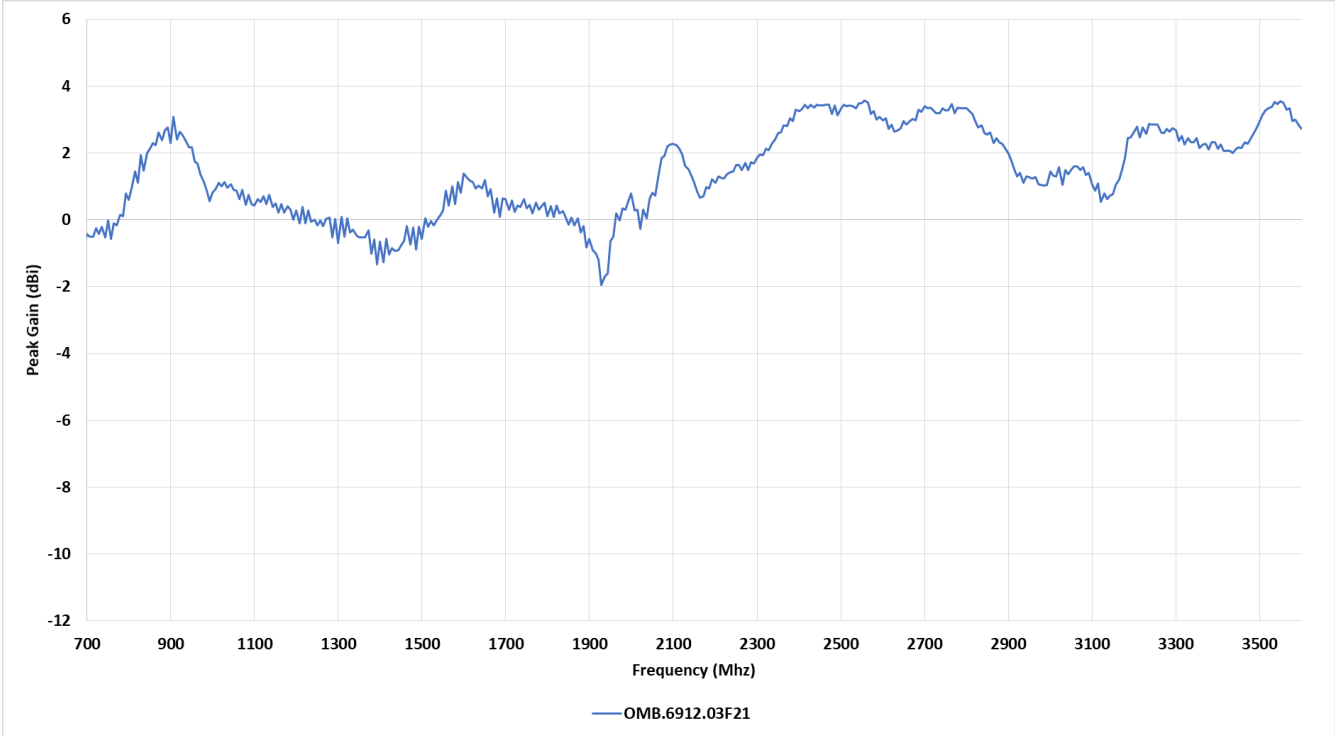

4 Radiation Properties

4.1 Measurement Setup

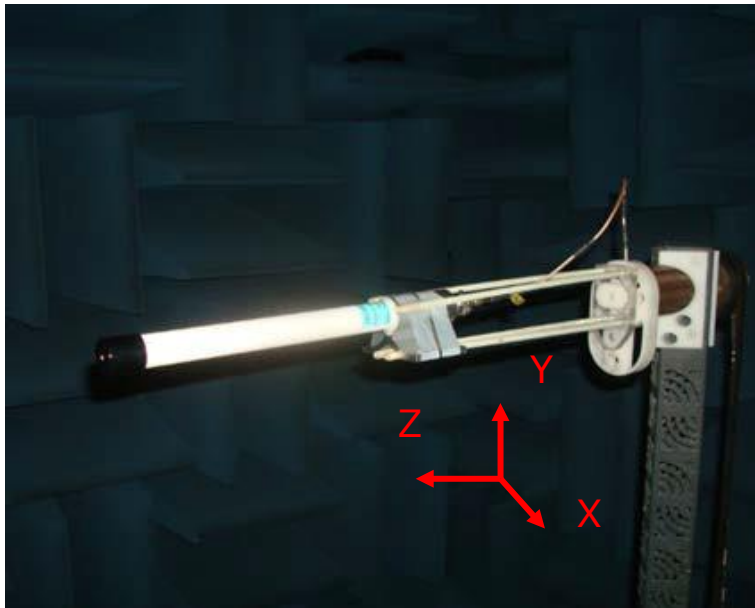

4.2 2D Radiation Pattern

XY Plane

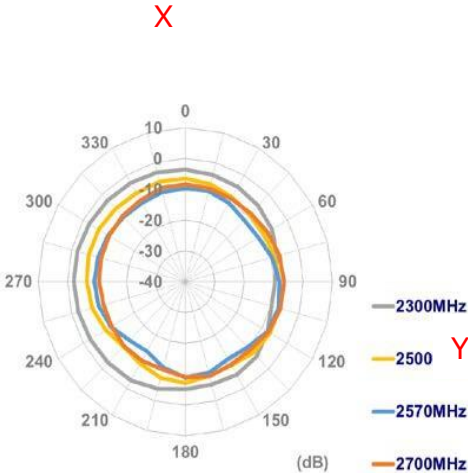
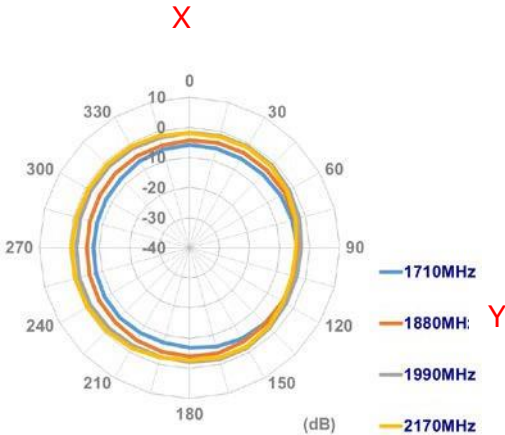
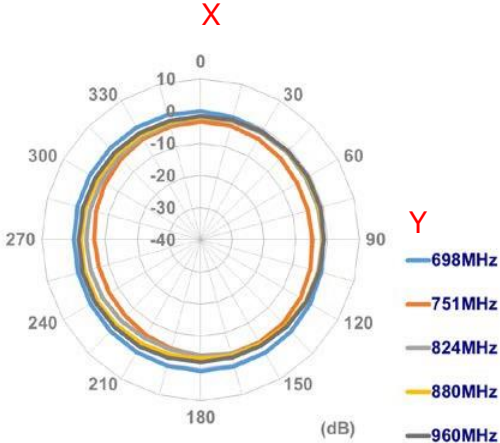

XZ Plane

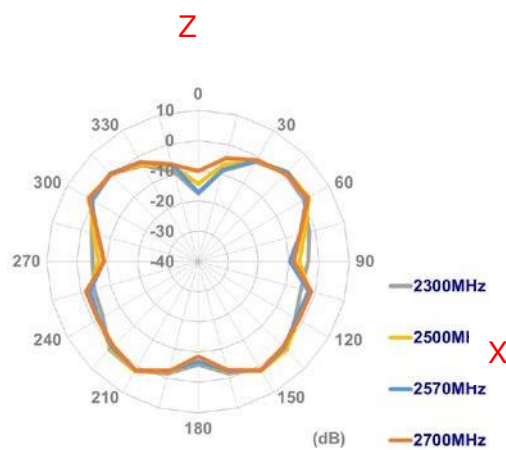
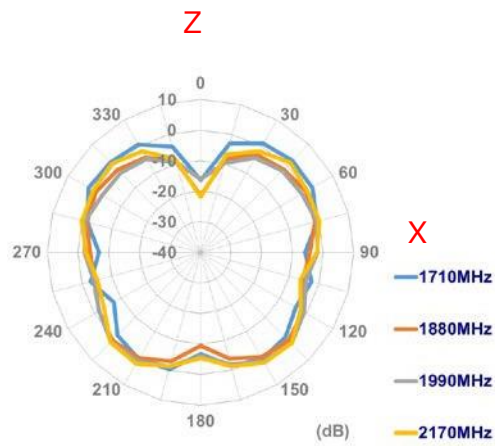
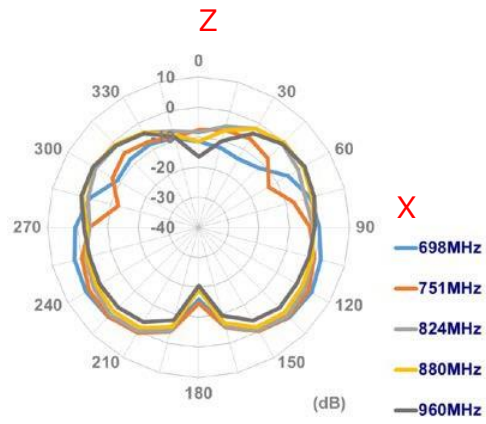

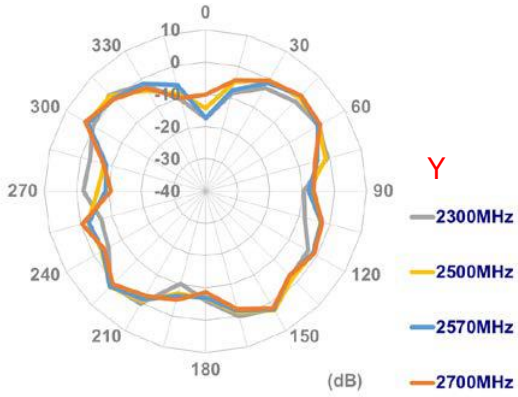

YZ Plane

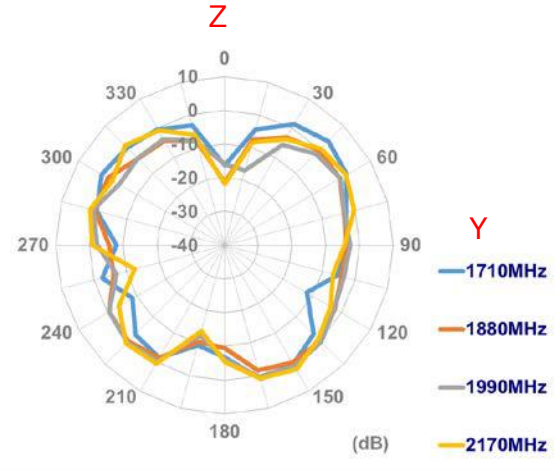
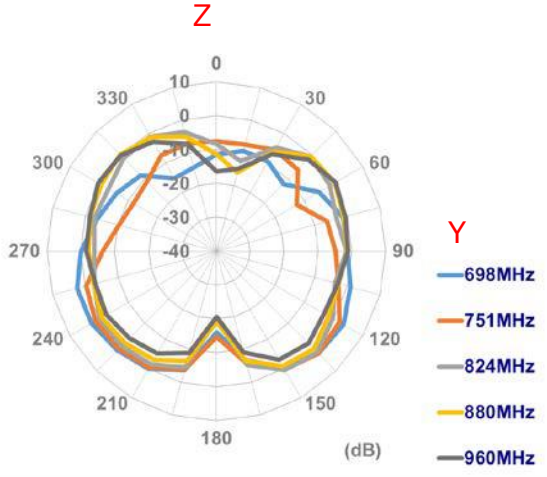

4.3 3D Radiation Pattern

@751MHz

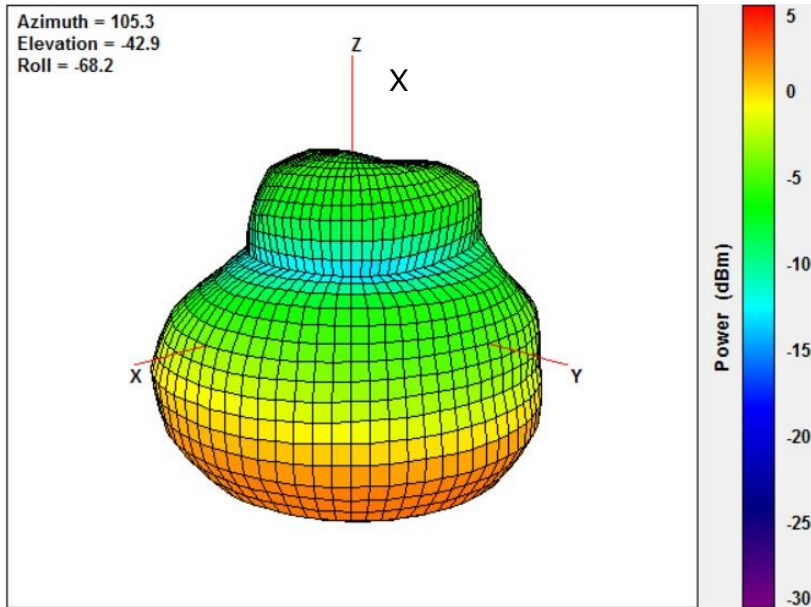

@824MHz

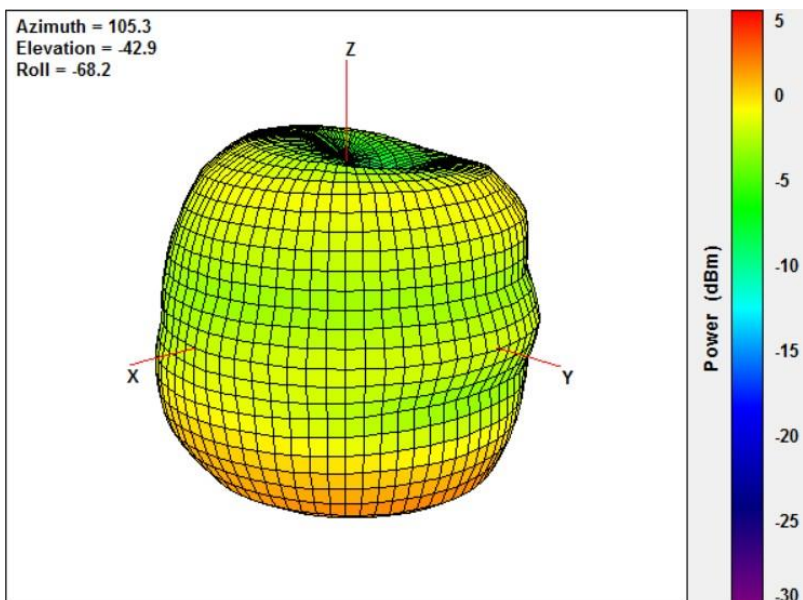

@880MHz

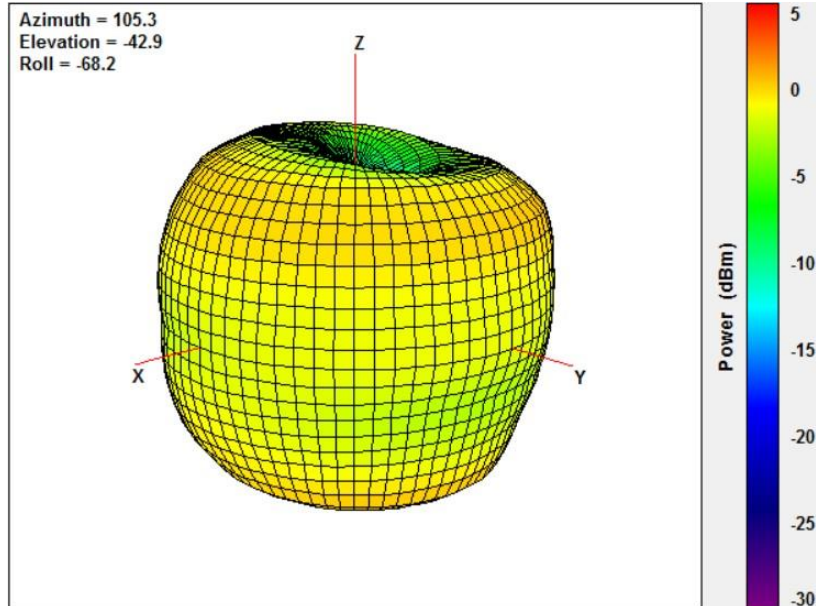

@960MHz

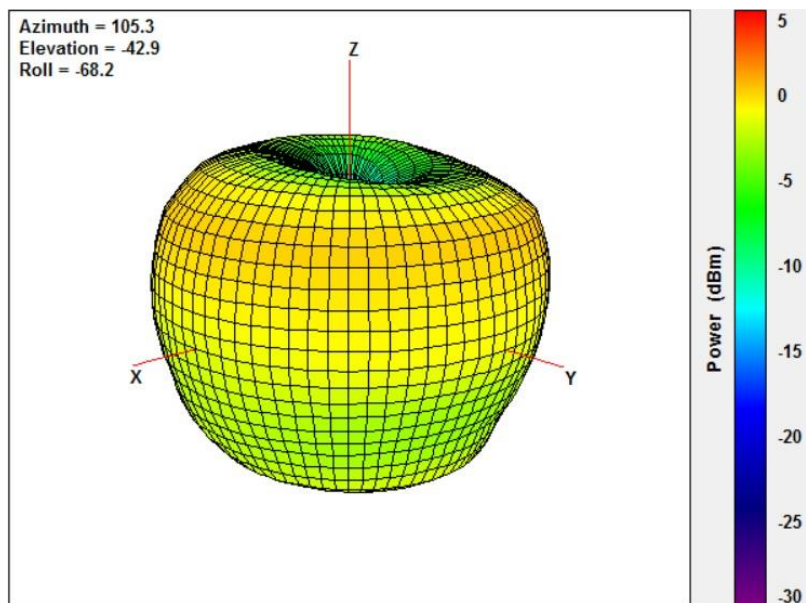

@1710MHz

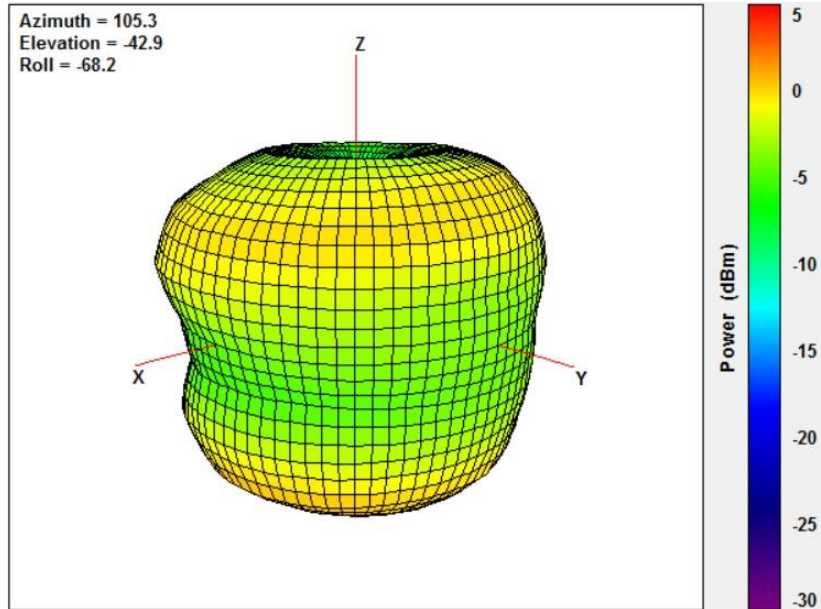

@1880MHz

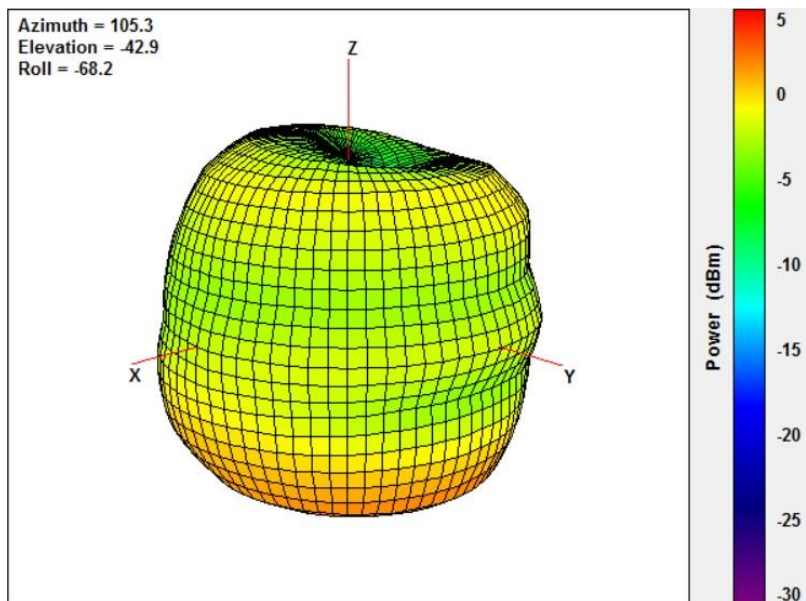

@1990MHz

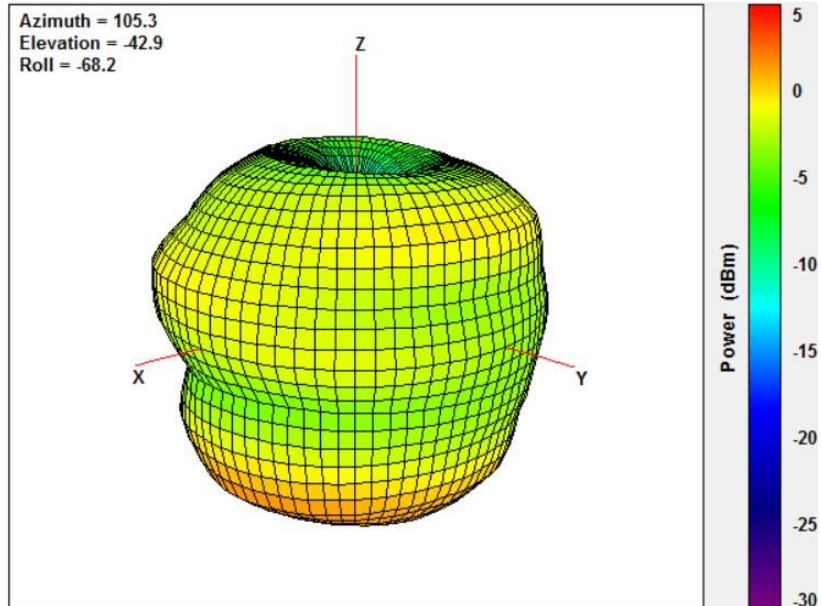

@2170MHz

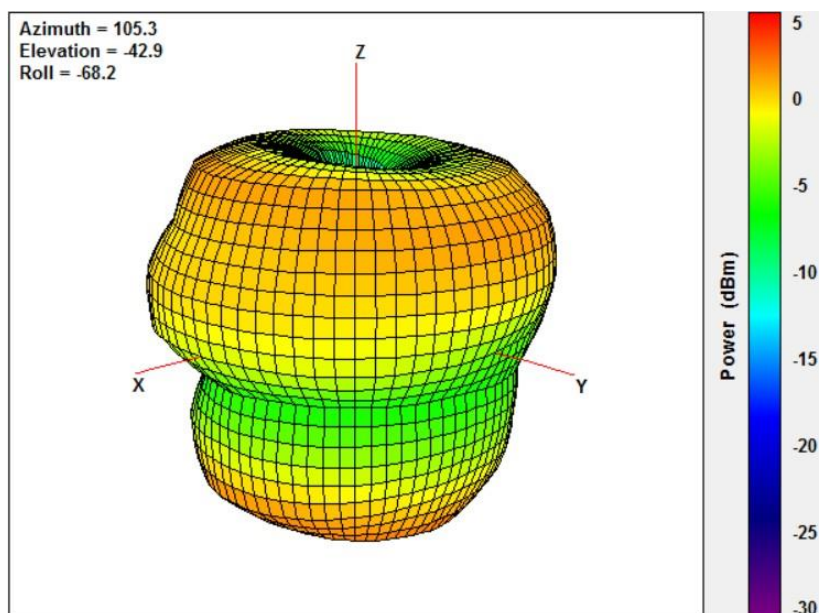

@2700MHz

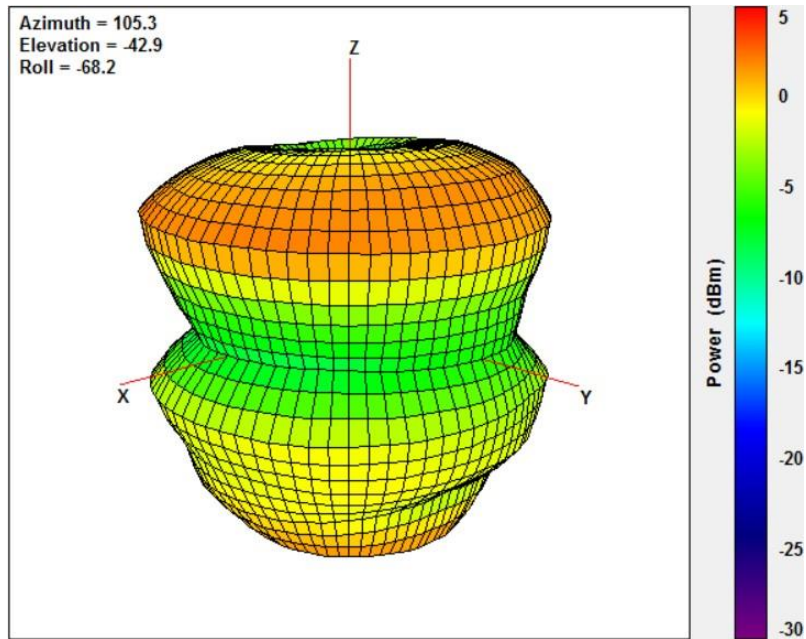

5 Mechanical Drawing (Unit: mm)

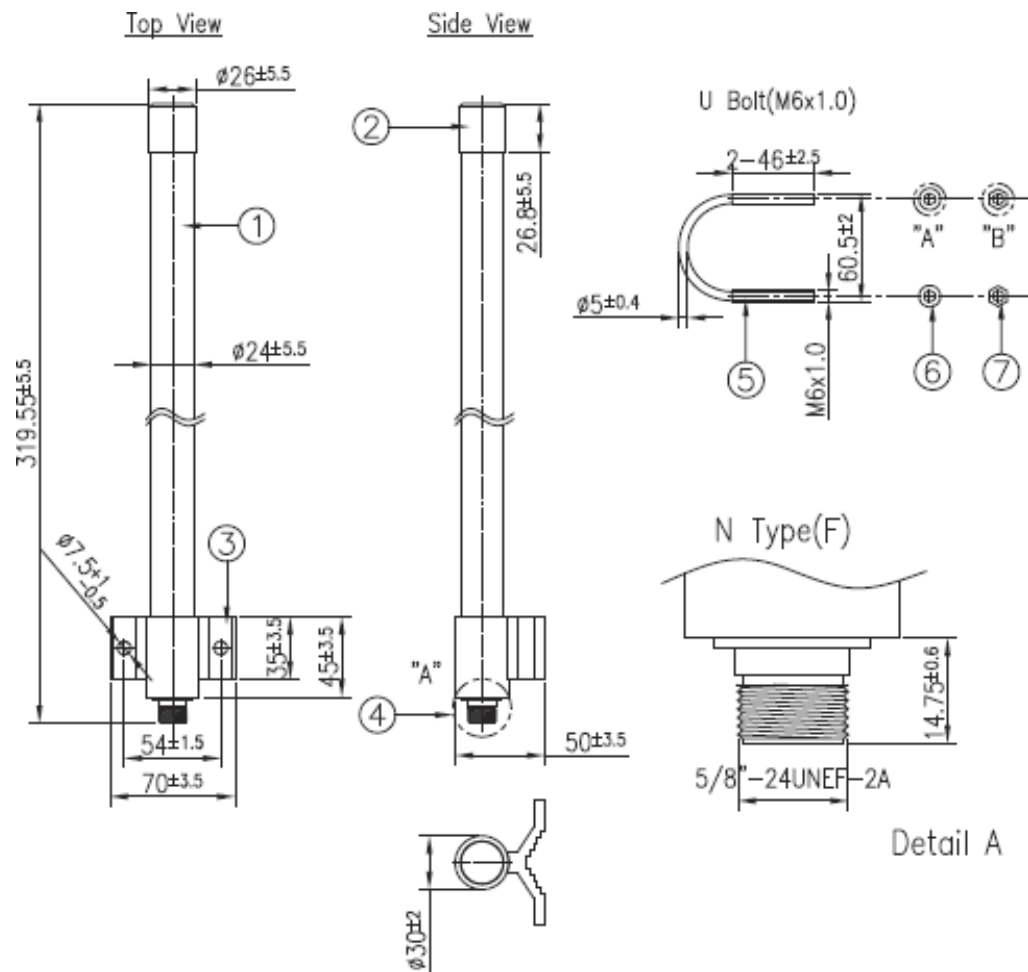

	Name	Material	Finish	QTY
1	OMB.6912 Antenna	Glass Fiber	White	1
2	Cover	ABS	Sliver	1
3	Bracket	Aluminum	Silver	1
4	N Type(F)	Brass	Ni Plated	1
5	M6 U Type Screw	Stainless Steel	Sliver	1
6	M6 Washer	Stainless Steel	Silver	2
7	M6 Nut	Stainless Steel	Sliver	2

6 Packaging Specs

1 OMB.6912.03F21 per tube
 Tube Dimensions - Ø80mm*Height 385mm
 Total Weight - 500g

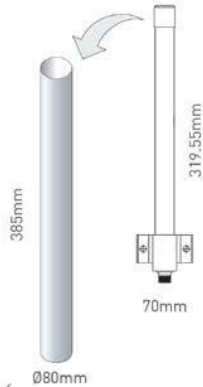

10 tubes per carton
 10 pcs OMB.6912.03F21 per carton
 Carton Dimensions - 400*390*180mm
 Weight - 5kg

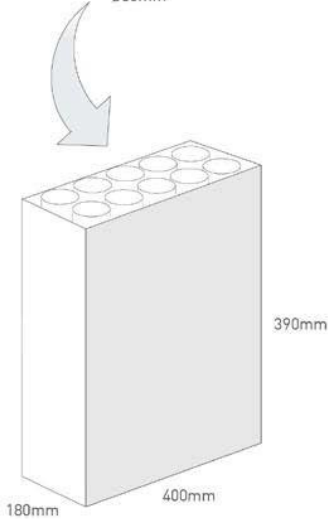

Pallet Dimensions 1200mm*1000mm*1460mm
 42 Cartons per Pallet
 6 Cartons per layer
 7 Layers

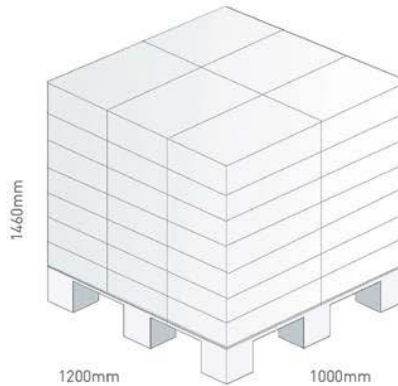

7 Antenna Installation Guide

