

NPN Silicon Phototransistor

OP505, OP505W, OP506, OP506W
OP535

Obsolete (OP505D, OP506C, OP705A)



Features:

- T-1 package style
- Variety of sensitivity ranges
- Choice of narrow or wide receiving angle
- Small package size ideal for space-limited applications
- 0.050" [1.27 mm] or 0.100" [2.54 mm] Lead spacing

Description:

Each OP505 and OP506 devices consist of an NPN silicon phototransistor, the OP535 device consist of an NPN silicon photodarlington transistor. All of the devices are molded in a blue-tinted T-1 (3 mm) epoxy package.

The OP505 and OP535 devices have a narrow receiving angle that provides excellent on-axis coupling while the OP506 device has a wider receiving angle for those applications where a narrow receiving angle of the OP505 and OP535 is not required. The OP505W and OP506W device have the widest receiving angle and provides relatively even reception over a large area.

Devices are 100% production tested, using infrared light for close correlation with Optek's GaAs and GaAlAs emitters.

Please refer to Application Bulletins 208 and 210 for additional design information and reliability (degradation) data.

Please see your OPTEK representative for custom versions of these devices.

Applications:

- Space-limited applications
- Interruptive applications to detect media which is semi-transparent to infrared light

Ordering Information				
Part Number	Sensor	Viewing Angle	Lead Spacing	Lead Length
OP505A	Transistor	20°	0.050" [1.27 mm]	0.50" [12.7 mm]
OP505B				
OP505C				
OP505D (Obsolete)				
OP505W		90°		
OP506A		20°		
OP506B				
OP506C (Obsolete)				
OP506W	90°			
OP535A	Darlington	20°	0.050" [1.27 mm]	
OP535B				
OP705A (Obsolete)	R _{BE}			
	Transistor			



RoHS

General Note

TT Electronics reserves the right to make changes in product specification without notice or liability. All information is subject to TT Electronics' own data and is considered accurate at time of going to print.

TT Electronics | OPTEK Technology
2900 E. Plano Pkwy, Plano, TX 75074 | Ph: +1 972 323 2200
www.ttelectronics.com | sensors@ttelectronics.com

NPN Silicon Phototransistor

OP505, OP505W, OP506, OP506W OP535



Obsolete (OP505D, OP506C, OP705A)

OP505, OP535

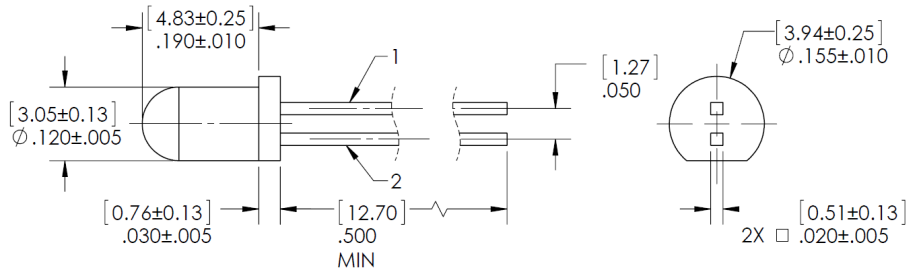

OP505W

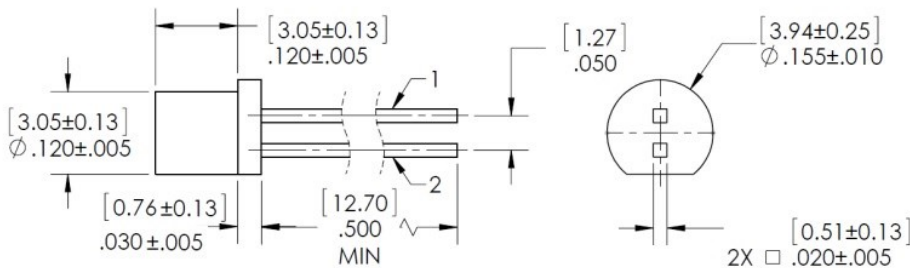

OP506

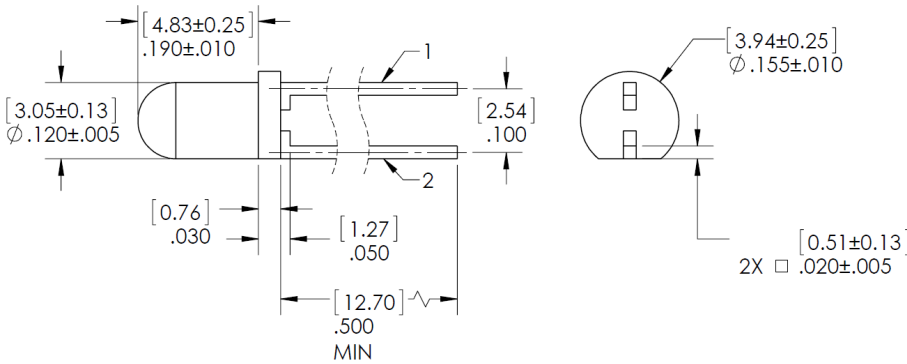

OP506W

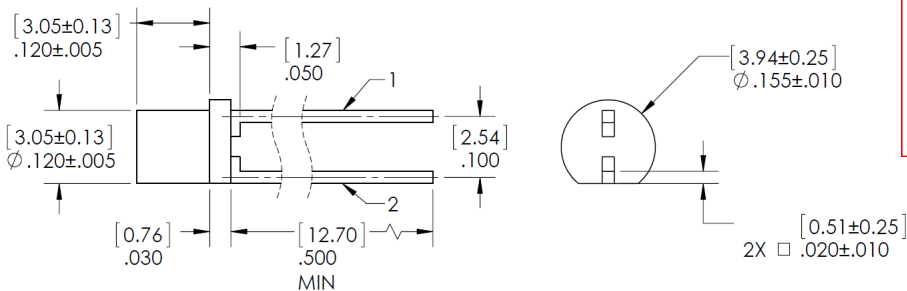

Pin #	Transistor
1	Emitter
2	Collector

OP505, OP506 OP505W, OP506W

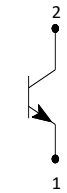

OP535

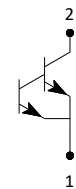

CONTAINS POLYSULFONE
Methanol and isopropanol alcohols are recommended cleaning agents. Housings are soluble in chlorinated hydrocarbons and keytones. Highly activated or water soluble fluxes may damage body. Testing reagents before use is recommended prior to use.

TOLERANCES ARE ± .010" [.25] UNLESS OTHERWISE STATED
DIMENSIONS ARE IN INCHES [MILLIMETERS]

General Note

TT Electronics reserves the right to make changes in product specification without notice or liability. All information is subject to TT Electronics' own data and is considered accurate at time of going to print.

NPN Silicon Phototransistor

OP505, OP505W, OP506, OP506W

OP535

Obsolete (OP505D, OP506C, OP705A)



Electrical Specifications

Absolute Maximum Ratings ($T_A = 25^\circ\text{C}$ unless otherwise noted)

Storage & Operating Temperature Range	-40° C to +100° C
Collector-Emitter Voltage (OP505, OP506, OP505W, OP506W)	30 V
Collector-Emitter Voltage (OP535)	15 V
Emitter-Collector Voltage (OP505 and OP506 series only)	5.0 V
Lead Soldering Temperature (1/16 inch (1.6 mm) from case for 5 seconds with soldering iron)	260° C
Power Dissipation	100 mW ⁽²⁾

Electrical Characteristics ($T_A = 25^\circ\text{C}$ unless otherwise noted)

OP505, OP506, OP505W, OP506W

SYMBOL	PARAMETER	MIN	TYP	MAX	UNITS	TEST CONDITIONS
$I_{C(ON)}$	On-State Collector Current					
	OP505A, OP506A	4.30	-	-	mA	$V_{CE} = 5\text{ V}$, $E_E = 0.50\text{ mW/cm}^2$, Note 3
	OP505B, OP506B	2.15	-	5.95		
OP505C	1.10	-	3.00			
	OP505W, OP506W	0.10	-	-	mA	$V_{CE} = 5\text{ V}$, $E_E = 0.75\text{ mW/cm}^2$, Note 3
$V_{CE(SAT)}$	Collector-Emitter Saturation Voltage					
	OP505, OP506	-	-	0.40	V	$I_C = 250\text{ }\mu\text{A}$, $E_E = 0.5\text{ mW/cm}^2$, Note 3
	OP505W, OP506W	-	-	0.40	V	$I_C = 50\text{ }\mu\text{A}$, $E_E = 0.75\text{ mW/cm}^2$, Note 3
I_{CEO}	Collector-Dark Current	-	-	100	nA	$V_{CE} = 10\text{ V}$, $E_E = 0$
$V_{(BR)CEO}$	Collector-Emitter Breakdown Voltage	30	-	-	V	$I_C = 100\text{ }\mu\text{A}$, $E_E = 0$
$V_{(BR)ECO}$	Emitter-Collector Breakdown Voltage					
	OP505, OP506	5	-	-	V	$I_E = 100\text{ }\mu\text{A}$, $E_E = 0$
$\Delta I_C/\Delta T$	Relative I_C Changes with Temperature	-	1.00	-	% / ° C	$V_{CE} = 5\text{ V}$, $E_E = 1.0\text{ mW/cm}^2$

Notes:

- (1) RMA flux is recommended. Duration can be extended to 10 seconds maximum when flow soldering. A maximum of 20 grams force may be applied to the leads when soldering.
- (2) Derate linearly 1.33 mW/° C above 25° C.
- (3) Light source is an unfiltered GaAs LED with a peak emission wavelength of 935 nm and a radiometric intensity level, which varies less than 10 % over the entire lens surface of the phototransistor being tested.
- (4) The knee point irradiance is defined as the irradiance required to increase $I_{C(ON)}$ to 50 μA .

General Note

TT Electronics reserves the right to make changes in product specification without notice or liability. All information is subject to TT Electronics' own data and is considered accurate at time of going to print.

TT Electronics | OPTEK Technology
2900 E. Plano Pkwy, Plano, TX 75074 | Ph: +1 972 323 2200
www.ttelectronics.com | sensors@ttelectronics.com

NPN Silicon Phototransistor
 OP505, OP505W, OP506, OP506W
 OP535
 Obsolete (OP505D, OP506C, OP705A)



Electrical Specifications

Electrical Characteristics ($T_A = 25^\circ\text{C}$ unless otherwise noted)

OP535

SYMBOL	PARAMETER	MIN	TYP	MAX	UNITS	TEST CONDITIONS	
$I_{C(ON)}$	On-State Collector Current	OP535A	10.5	-	-	mA	$V_{CE} = 5\text{ V}$, $E_E = 0.13\text{ mW/cm}^2$, Note 3
		OP535B	3.5	-	32.0		
$V_{CE(SAT)}$	Collector-Emitter Saturation Voltage	-	-	1.10	V	$I_C = 400\ \mu\text{A}$, $E_E = 0.13\text{ mW/cm}^2$, Note 3	
I_{CEO}	Collector-Dark Current	-	-	100	nA	$V_{CE} = 10\text{ V}$, $E_E = 0$	
$V_{(BR)CEO}$	Collector-Emitter Breakdown Voltage	15.0	-	-	V	$I_C = 1.0\text{ mA}$, $E_E = 0$	
$V_{(BR)ECO}$	Emitter-Collector Breakdown Voltage	5.0	-	-	V	$I_E = 100\ \mu\text{A}$, $E_E = 0$	

General Note

TT Electronics reserves the right to make changes in product specification without notice or liability. All information is subject to TT Electronics' own data and is considered accurate at time of going to print.

TT Electronics | OPTEK Technology
 2900 E. Plano Pkwy, Plano, TX 75074 | Ph: +1 972 323 2200
www.ttelectronics.com | sensors@ttelectronics.com

NPN Silicon Phototransistor

OP505, OP505W, OP506, OP506W
OP535



Obsolete (OP505D, OP506C, OP705A)

Performance

OP505A, OP505B, OP505C

Typical Spectral Response

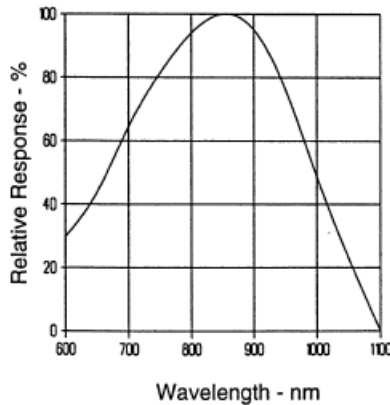

Coupling Characteristics
OP165 and OP505

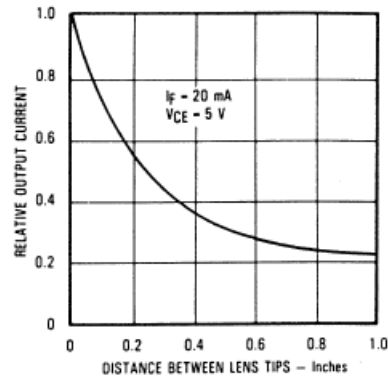

Normalized Collector Current
vs. Angular Displacement

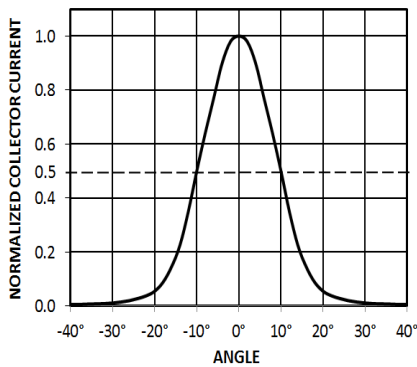

On-State Collector Current
vs. Irradiance

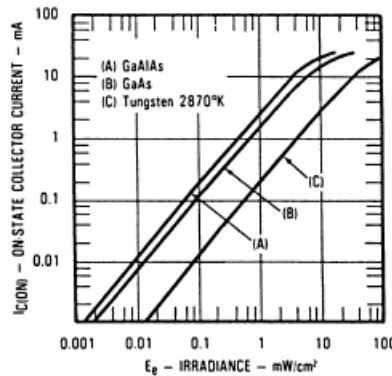

Normalized Collector Current vs.
Collector to Emitter Voltage

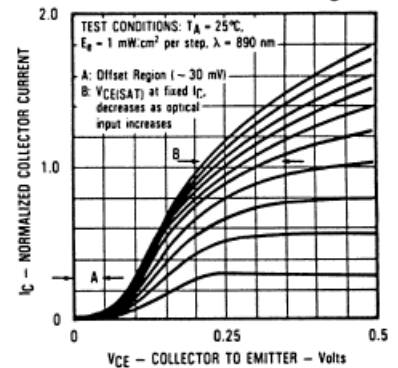

Rise and Fall Time
vs. Load Resistance

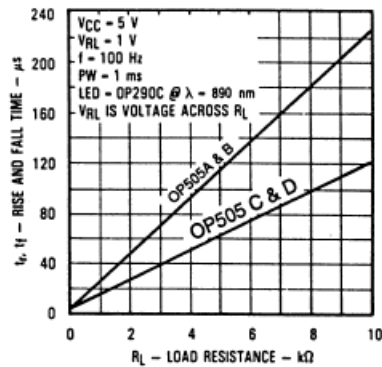

Normalized Output
vs. Frequency

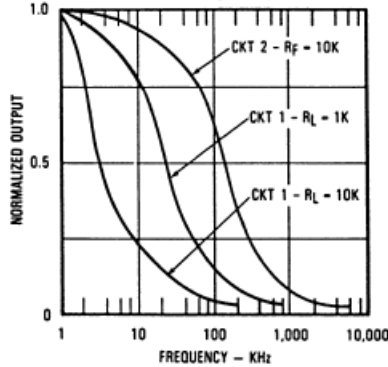

Switching Time
Test Circuit

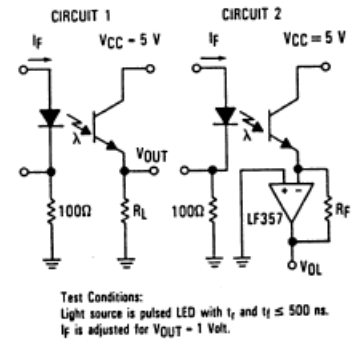

General Note

TT Electronics reserves the right to make changes in product specification without notice or liability. All information is subject to TT Electronics' own data and is considered accurate at time of going to print.

TT Electronics | OPTEK Technology
2900 E. Plano Pkwy, Plano, TX 75074 | Ph: +1 972 323 2200
www.ttelectronics.com | sensors@ttelectronics.com

NPN Silicon Phototransistor

OP505, OP505W, OP506, OP506W
OP535

Obsolete (OP505D, OP506C, OP705A)



Performance

OP505W

Typical Spectral Response

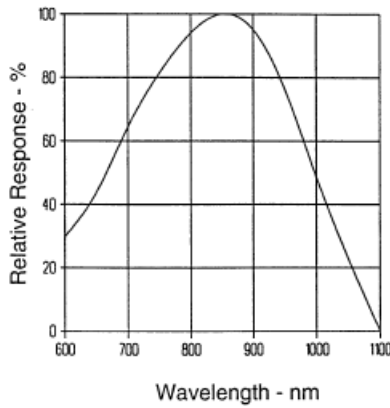

Coupling Characteristics of OP165W and OP505W

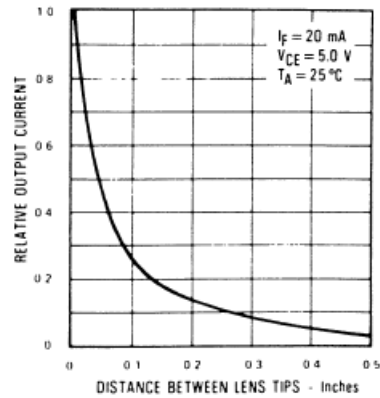

Normalized Collector Current vs. Angular Displacement

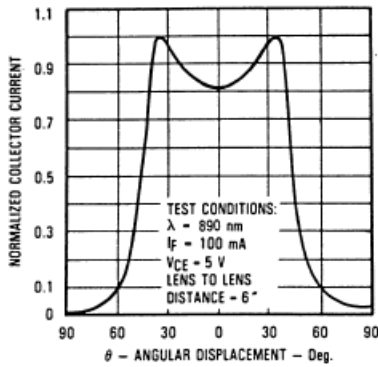

On-State Collector Current vs Irradiance

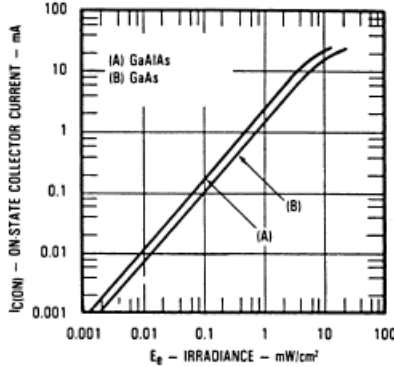

Normalized Collector Current vs. Collector to Emitter Voltage

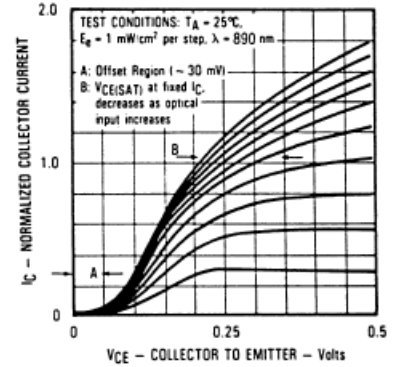

Rise and Fall Time vs. Load Resistance

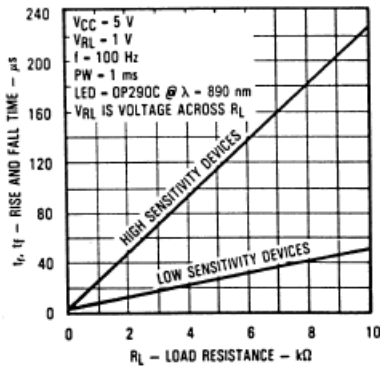

Normalized Output vs. Frequency

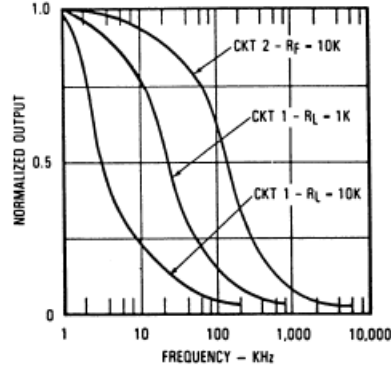

Switching Time Test Circuit

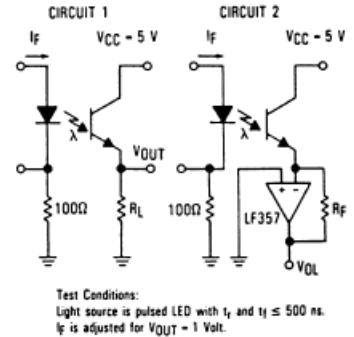

General Note

TT Electronics reserves the right to make changes in product specification without notice or liability. All information is subject to TT Electronics' own data and is considered accurate at time of going to print.

TT Electronics | OPTEK Technology
2900 E. Plano Pkwy, Plano, TX 75074 | Ph: +1 972 323 2200
www.ttelectronics.com | sensors@ttelectronics.com

NPN Silicon Phototransistor

OP505, OP505W, OP506, OP506W
OP535

Obsolete (OP505D, OP506C, OP705A)



Performance

OP506A, OP506B

Typical Spectral Response

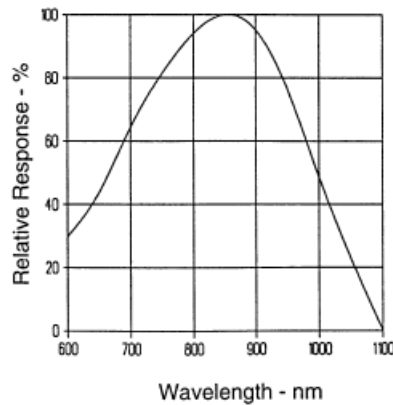

Coupling Characteristics of OP166 and OP506

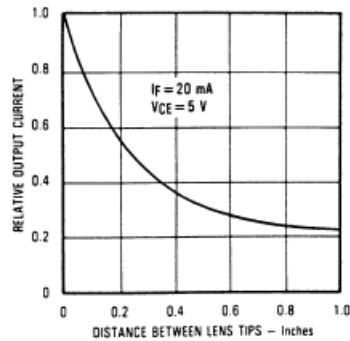

Normalized Collector Current vs. Angular Displacement

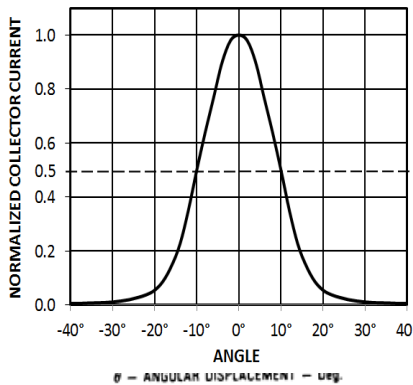

On-State Collector Current vs Irradiance

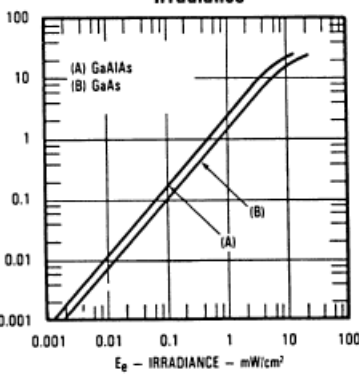

Normalized Collector Current vs Collector-to-Emitter Voltage

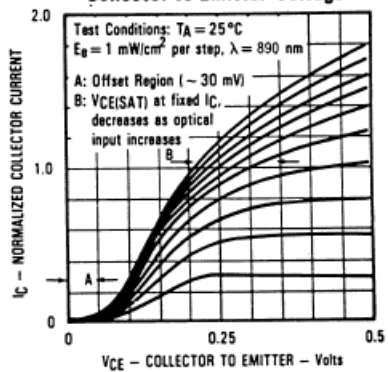

Rise and Fall Time vs Load Resistance

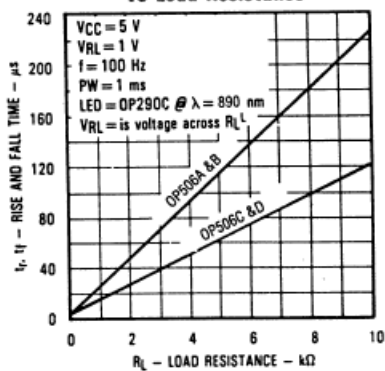

Normalized Output vs Frequency

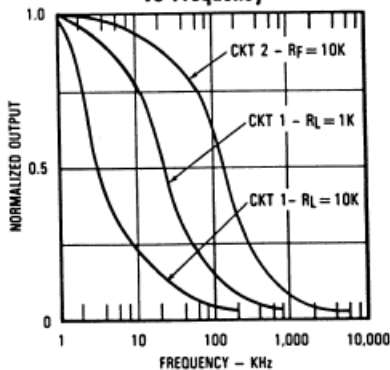

Switching Time Test Circuit

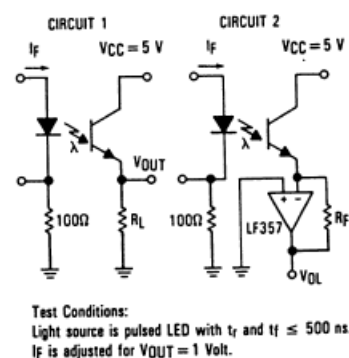

General Note
TT Electronics reserves the right to make changes in product specification without notice or liability. All information is subject to TT Electronics' own data and is considered accurate at time of going to print.

TT Electronics | OPTEK Technology
2900 E. Plano Pkwy, Plano, TX 75074 | Ph: +1 972 323 2200
www.ttelectronics.com | sensors@ttelectronics.com

NPN Silicon Phototransistor

OP505, OP505W, OP506, OP506W
OP535

Obsolete (OP505D, OP506C, OP705A)



Performance

OP506W

Typical Spectral Response

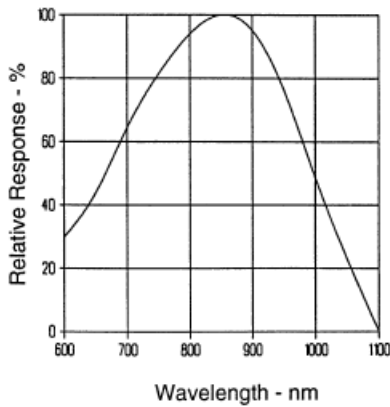

Coupling Characteristics

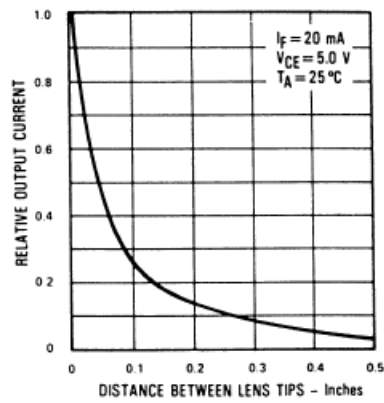

Normalized Collector Current vs. Angular Displacement

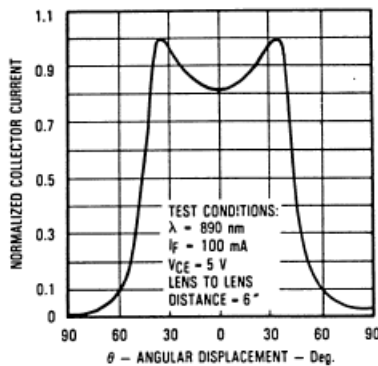

On-State Collector Current vs Irradiance

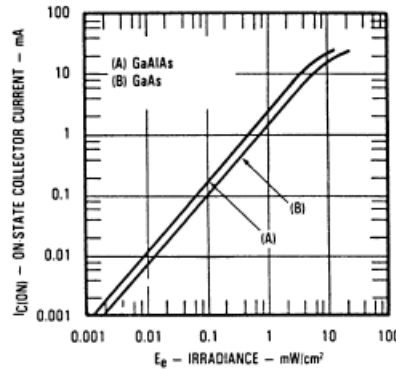

Normalized Collector Current vs Collector-to-Emitter Voltage

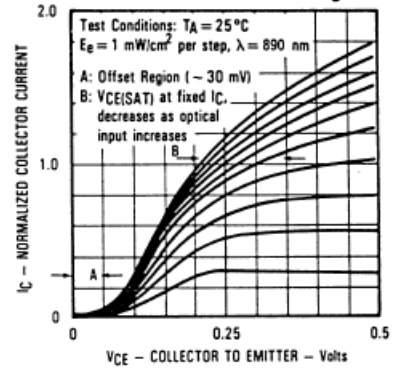

Rise and Fall Time vs Load Resistance

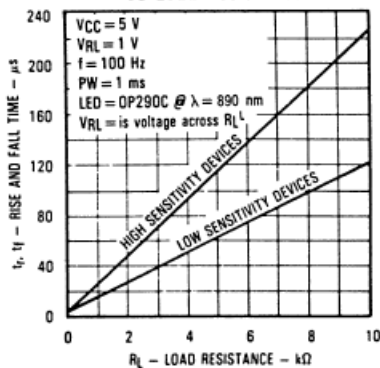

Normalized Output vs Frequency

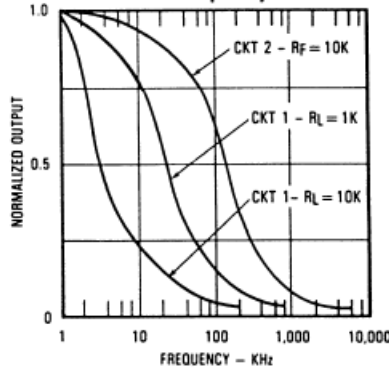

Switching Time Test Circuit

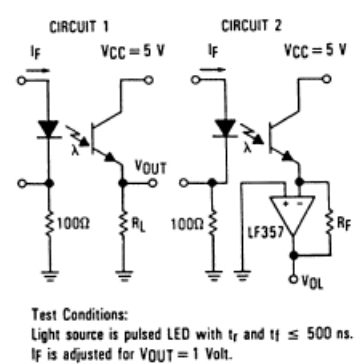

General Note

TT Electronics reserves the right to make changes in product specification without notice or liability. All information is subject to TT Electronics' own data and is considered accurate at time of going to print.