

NPN Phototransistor

OP804SL, OP805SL, OP830SL

OP800WSL, OP801WSL, OP802WSL, OP830WSL

Obsolete (OP800SL)

Features:

- TO-18 hermetically sealed package
- Mechanically and spectrally matched to OP130 and OP230 LEDs
- TX and TXV process available (see Hi-Rel section)
- Choice of narrow or wide receiving angle
- Variety of sensitivity ranges
- Enhanced temperature range



Description:

Each device in this series consists of a NPN silicon phototransistor mounted in a hermetically sealed TO-18 package that offers high power dissipation and superior hostile environment operation. The **OP800SL (Obsolete)**, **OP804SL**, **OP805SL** and **OP830SL** devices have a narrow receiving angle that provides excellent on-axis coupling and a bonded base lead that enables conventional transistor biasing. The **OP800WSL**, **OP801WSL**, **OP802WSL** and **OP830WSL** all have a wide receiving angle that provides relatively even reception over a large area.

Devices are 100% production tested using an infrared light source for close correlation with OPTEK's GaAs and GaAlAs emitters. *The OP800SL and devices are mechanically and spectrally matched to OP130 and OP230 series LEDs. The OP800WSL devices are mechanically and spectrally matched to OP130W and OP230W series devices.*

Please refer to Application Bulletins 208 and 210 for additional design information and reliability (degradation) data.

Applications:

- Space-limited applications
- Hostile environment applications
- Applications requiring high power dissipation

Part Number Guide — OPXXX

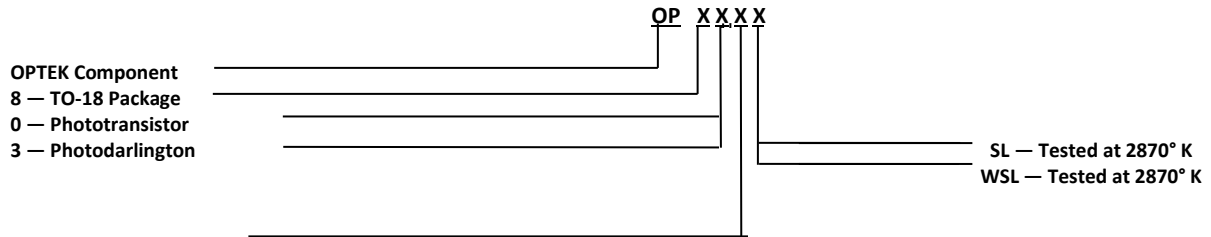

Part Description:

- OP80__SL** = TO-18 dome lens, phototransistor
4 and 5 sensitivity levels
tested with 2870° K light source
- OP80__WSL** = TO-18 flat lens, phototransistor
0 through 2 sensitivity levels
tested with 2870° K light source
- OP830SL** = TO-18 dome lens, photodarlington
tested with 2870° K light source
- OP830WSL** = TO-18 flat lens, photodarlington
tested with 2870° K light source



RoHS

General Note

TT Electronics reserves the right to make changes in product specification without notice or liability. All information is subject to TT Electronics' own data and is considered accurate at time of going to print.

NPN Phototransistor

OP804SL, OP805SL, OP830SL

OP800WSL, OP801WSL, OP802WSL, OP830WSL

Obsolete (OP800SL)



OP800SL, OP830SL

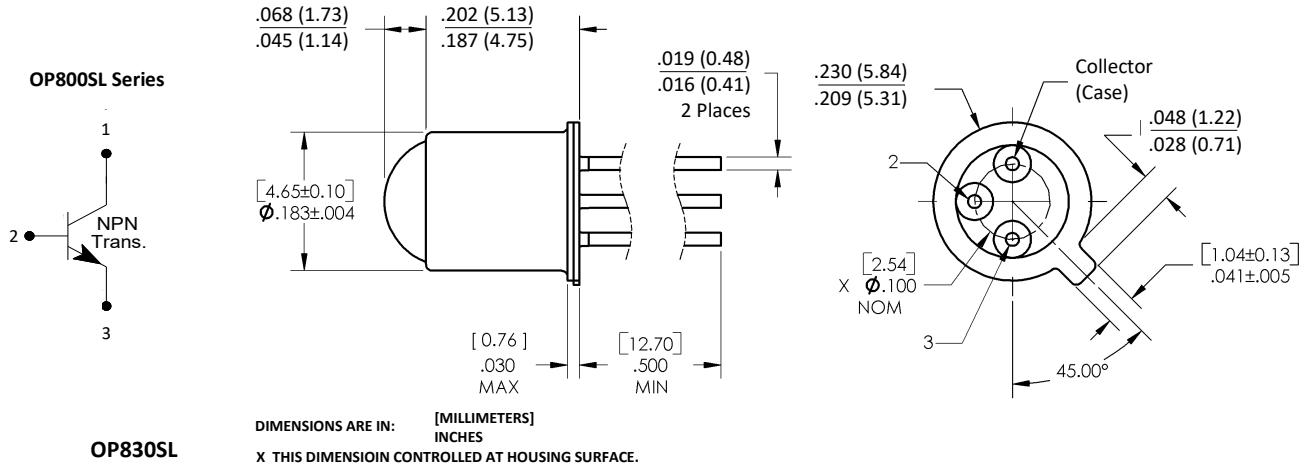

OP800WSL, OP830WSL

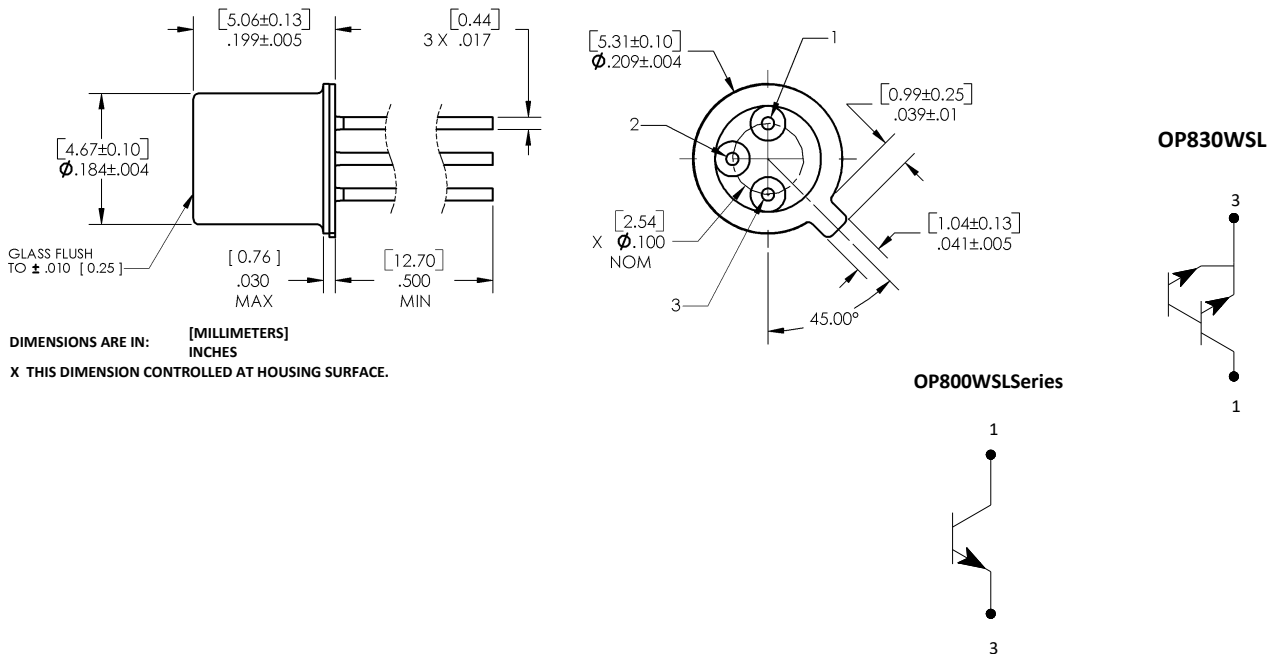

General Note
 TT Electronics reserves the right to make changes in product specification without notice or liability. All information is subject to TT Electronics' own data and is considered accurate at time of going to print.

TT Electronics | OPTEK Technology
 2900 E. Plano Pkwy, Plano, TX 75074 | Ph: +1 972 323 2200
 www.ttelectronics.com | sensors@ttelectronics.com

NPN Phototransistor

OP804SL, OP805SL, OP830SL

OP800WSL, OP801WSL, OP802WSL, OP830WSL

Obsolete (OP800SL)



Electrical Specifications

Absolute Maximum Ratings ($T_A = 25^\circ\text{C}$ unless otherwise noted)	
Storage Temperature Range	-65° C to +150° C
Operating Temperature Range	-65° C to +125° C
Collector-Base Voltage (applies to OP800SL only - does not apply to OP800WSL)	30 V
Collector-Emitter Voltage OP800 (SL, WSL) OP830 (SL, WSL)	30 V 15 V
Emitter-Base Voltage (applies to OP800 (SL, WSL) only)	5 V
Emitter-Collector Voltage (applies to all OP800 and OP830 devices)	5 V
Continuous Collector Current	50 mA
Lead Soldering Temperature [1/16 inch (1.6 mm) from case for 5 seconds with soldering iron]	260° C ⁽¹⁾
Power Dissipation	250 mW ⁽²⁾

Notes:

1. RMA flux is recommended. Duration can be extended to 10 seconds maximum when flow soldering. A maximum 20 grams force may be applied to the leads when soldering.
2. Derate linearly 2.5 mW/° C above 25° C.
3. Junction temperature maintained at 25° C.
4. Light source is an unfiltered tungsten bulb operating at $T_C = 2870\text{ K}$.

Switching Time Test Circuit

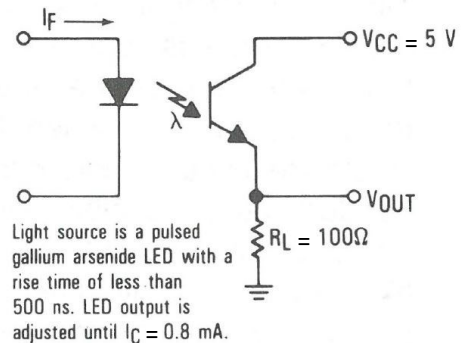

General Note

TT Electronics reserves the right to make changes in product specification without notice or liability. All information is subject to TT Electronics' own data and is considered accurate at time of going to print.

TT Electronics | OPTEK Technology
2900 E. Plano Pkwy, Plano, TX 75074 | Ph: +1 972 323 2200
www.ttelectronics.com | sensors@ttelectronics.com

NPN Phototransistor

OP804SL, OP805SL, OP830SL

OP800WSL, OP801WSL, OP802WSL, OP830WSL

Obsolete (OP800SL)



Electrical Specifications

Electrical Characteristics (T _A = 25° C unless otherwise noted)						
SYMBOL	PARAMETER	MIN	TYP	MAX	UNITS	TEST CONDITIONS
I _{C(ON)} ⁽³⁾	On-State Collector Current OP800SL OP804SL OP805SL OP800WSL OP801WSL OP802WSL	0.5 7.0 15 0.3 0.5 2.5	- - - - - -	- 22 - 3 2 3	mA	V _{CE} = 5 V, E _E = 2.5 mW/cm ²⁽²⁾⁽³⁾⁽⁴⁾
	OP830SL OP830WSL	15 4	- -	- -		V _{CE} = 5 V, E _E = 0.25 mW/cm ²⁽²⁾⁽³⁾⁽⁴⁾
I _{CEO}	Collector Dark Current OP800 (SL, WSL) OP830 (SL, WSL)	- -	- -	100 1	nA	V _{CE} = 10 V, E _E = 0
V _{(BR)CEO}	Collector-Emitter Breakdown Voltage OP800 (SL, WSL) OP830 (SL, WSL)	30 15	- -	- -	V	I _C = 100 μA
V _{(BR)CBO}	Collector-Base Breakdown Voltage [applies to OP800SL only]	30	-	-	V	I _C = 100 μA
V _{(BR)ECO}	Emitter-Collector Breakdown Voltage	5.0	-	-	V	I _E = 100 μA
V _{(BR)EBO}	Emitter-Base Breakdown Voltage [applies to OP800SL only]	5.0	-	-	V	I _E = 100 μA
V _{CE(SAT)} ⁽³⁾	Collector-Emitter Saturation Voltage OP800WSL OP800SL OP830SL OP830WSL	- - - -	- - - -	0.4 0.4 1.2 1.2	V	I _C = .4 mA, E _E = 2.5 mW/cm ²⁽⁴⁾ I _C = 400 μA, E _E = 2.5 mW/cm ²⁽⁴⁾ I _C = 1 mA, E _E = 0.25 mW/cm ²⁽⁴⁾ I _C = 1.0 mA, E _E = 0.25 mW/cm ²⁽⁴⁾
t _r	Rise Time	-	7	-	μs	V _{CC} = 5 V, I _C = 0.80 mA, R _L = 100 Ω (See Test Circuit)
t _f	Fall Time	-	7	-	μs	

Notes:

1. RMA flux is recommended. Duration can be extended to 10 seconds maximum when flow soldering. A maximum 20 grams force may be applied to the leads when soldering.
2. Derate linearly 2.5 mW/° C above 25° C.
3. Junction temperature maintained at 25° C.
4. Light source is an unfiltered tungsten bulb operating at CT = 2870 K or equivalent infrared source.

General Note

TT Electronics reserves the right to make changes in product specification without notice or liability. All information is subject to TT Electronics' own data and is considered accurate at time of going to print.

TT Electronics | OPTEK Technology
2900 E. Plano Pkwy, Plano, TX 75074 | Ph: +1 972 323 2200
www.ttelectronics.com | sensors@ttelectronics.com

NPN Phototransistor

OP804SL, OP805SL, OP830SL

OP800WSL, OP801WSL, OP802WSL, OP830WSL

Obsolete (OP800SL)



Performance

OP800SL Series

Typical Spectral Response

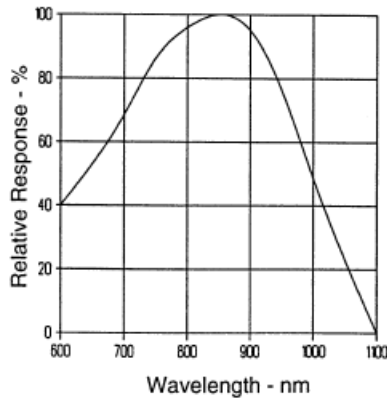

Coupling Characteristics of OP130 and OP800SL

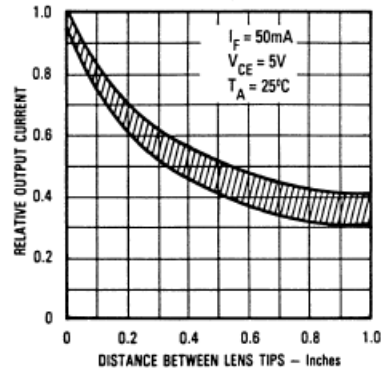

Collector Dark Current vs. Ambient Temperature

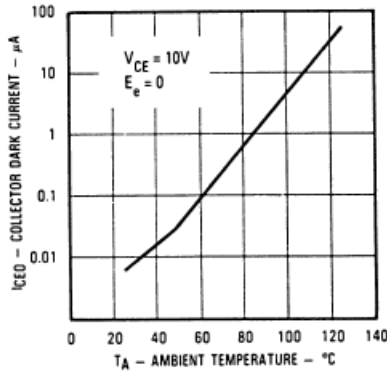

Normalized Collector Current vs. Ambient Temperature

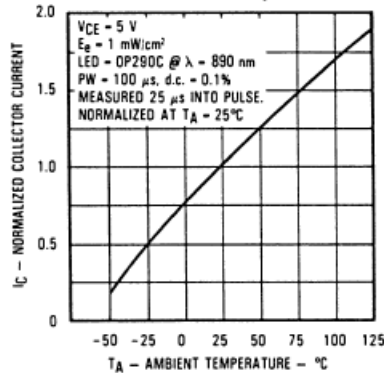

Collector Current vs. Irradiance

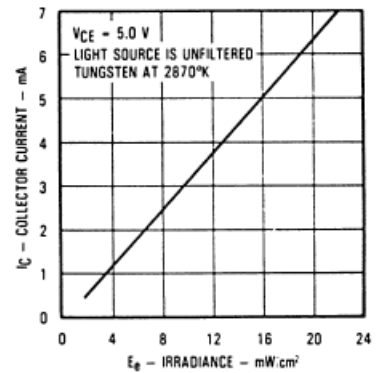

Rise and Fall Time vs. Load Resistance

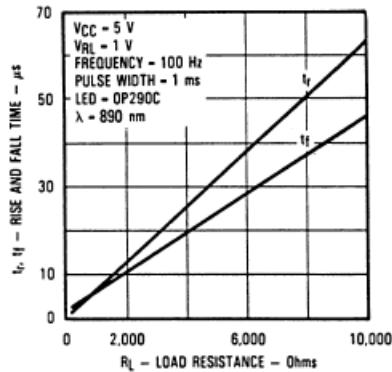

Normalized Collector Current vs. Angular Displacement

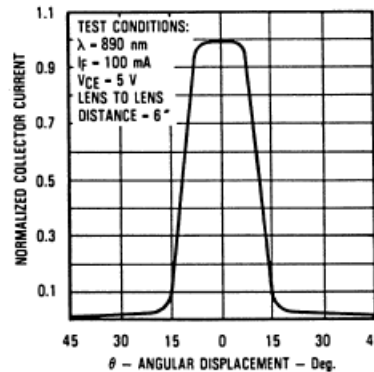

General Note

TT Electronics reserves the right to make changes in product specification without notice or liability. All information is subject to TT Electronics' own data and is considered accurate at time of going to print.

TT Electronics | OPTEK Technology
2900 E. Plano Pkwy, Plano, TX 75074 | Ph: +1 972 323 2200
www.ttelectronics.com | sensors@ttelectronics.com

NPN Phototransistor

OP804SL, OP805SL, OP830SL
 OP800WSL, OP801WSL, OP802WSL, OP830WSL
 Obsolete (OP800SL)



Performance

OP800WSL Series

Typical Spectral Response



Coupling Characteristics of OP130W and OP800W



Collector Dark Current vs. Ambient Temperature



Normalized Collector Current vs. Ambient Temperature

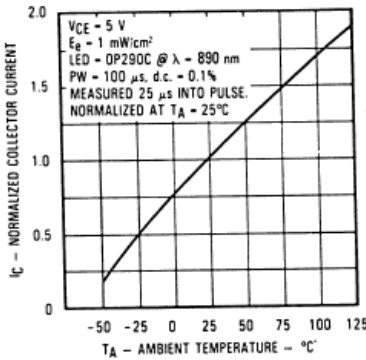

Collector Current vs. Irradiance



Rise and Fall Time vs. Load Resistance



Normalized Collector Current vs. Angular Displacement

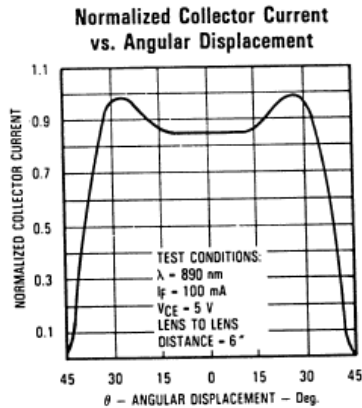

Switching Time Test Circuit

General Note

TT Electronics reserves the right to make changes in product specification without notice or liability. All information is subject to TT Electronics' own data and is considered accurate at time of going to print.

TT Electronics | OPTEK Technology
 2900 E. Plano Pkwy, Plano, TX 75074 | Ph: +1 972 323 2200
 www.ttelectronics.com | sensors@ttelectronics.com

NPN Phototransistor

OP804SL, OP805SL, OP830SL
 OP800WSL, OP801WSL, OP802WSL, OP830WSL
 Obsolete (OP800SL)



Performance

OP830SL Series

Typical Spectral Response

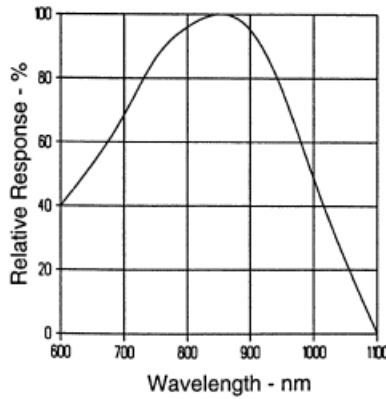

Coupling Characteristics of OP130 and OP830

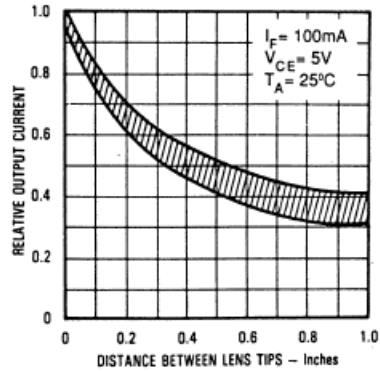

Collector Dark Current vs. Ambient Temperature

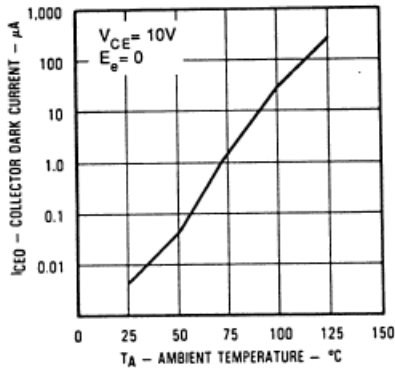

Collector Current vs. Ambient Temperature

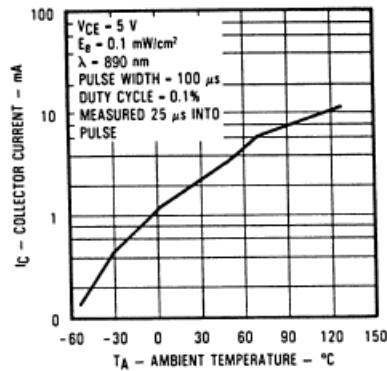

Collector Current vs. Irradiance

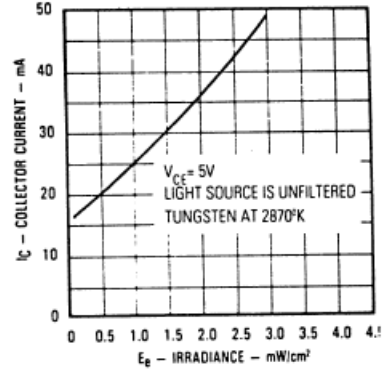

Rise and Fall Time vs. Load Resistance

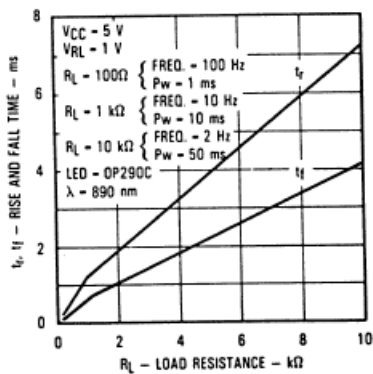

Normalized Collector Current vs. Angular Displacement

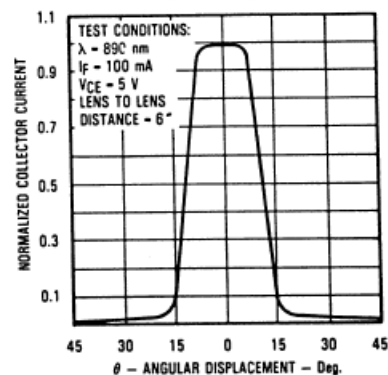

General Note

TT Electronics reserves the right to make changes in product specification without notice or liability. All information is subject to TT Electronics' own data and is considered accurate at time of going to print.

TT Electronics | OPTEK Technology
 2900 E. Plano Pkwy, Plano, TX 75074 | Ph: +1 972 323 2200
 www.ttelectronics.com | sensors@ttelectronics.com