

Reflective Object Sensor

OPB703 through OPB705,
 OPB703WZ through OPB705WZ,
 OPB70AWZ, OPB70DWZ, OPB70EWZ, OPB70FWZ

Obsolete (OPB70BWZ, OPB70CWZ, OPB70HWZ, OPB704G)

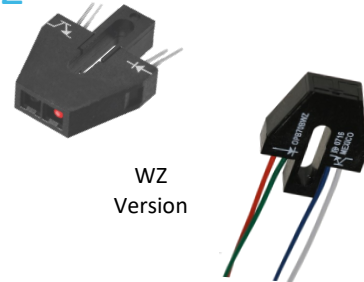

Features:

- Phototransistor output
- High sensitivity
- Low-cost plastic housing
- Available with lenses for dust protection and ambient light filtration
- Focused for maximum sensitivity

Description:

The **OPB703**, **OPB704** and **OPB705** consist of an Infrared (890 nm) Light Emitting Diode (LED) and a NPN silicon Phototransistor, mounted side-by-side on converging optical axes in a black plastic housing and are designed for PCBoard mounting. The **OPB703WZ**, **OPB704WZ** and **OPB705WZ** are designed for remote mounting utilizing interconnect wires of UL approved 26 AWG, 24" (61.0 cm) minimum length, stripped and tinned.

The **OPB70AWZ** consists of an Infrared (890 nm) Light Emitting Diode (LED) and a NPN silicon Photodarlington, mounted side-by-side on converging optical axes in a black plastic housing and is designed for remote mounting utilizing interconnect wires of UL approved 26 AWG, 24" (61.0 cm) minimum length, stripped and tinned.

The **OPB70DWZ through OPB70FWZ** consist of a Visible (Red 660 nm) Light Emitting Diode (LED) and a NPN silicon Phototransistor or Rbe Phototransistor, mounted side-by-side on converging optical axes in a black plastic housing and are designed for remote mounting utilizing interconnect wires of UL approved 26 AWG, 24" (61.0 cm) minimum length, stripped and tinned.

Various lens options are available: No lens for the (**OPB703**, **OPB703WZ**), blue window for dust protection for the (**OPB704**, **OPB704WZ**) and aperture lens for improved resolution for the (**OPB705**, **OPB705WZ**, **OPB70AWZ**, **OPB70DWZ**). The **OPB704GWZ** offers excellent protection for dirty environments.

The phototransistor responds to illumination from the emitter when a reflective object passes within the field of view centered typically at 0.15" (3.8 mm).

Custom electrical, wire, cabling and connectors are available. Contact your local representative or OPTEK for more information.

Applications:

- Non-contact reflective object sensor
- Assembly line automation
- Machine automation
- Machine safety
- End of travel sensor
- Door sensor
- Mark Detection
- Office Equipment
- Gaming Equipment

Ordering Information						
Part	LED Peak	Detector	Optical Cover	Lead or Wire		
OPB703	890 nm	Transistor	None	0.160" Leads		
OPB703WZ				24" / 26 AWG Wire		
OPB704				0.160" Leads		
OPB704WZ				24" / 26 AWG Wire		
OPB70HWZ (Obsolete)			Blue Window	24" / 26 AWG Wire		
OPB704G (Obsolete)				0.160" Leads		
OPB704GWZ				24" / 26 AWG Wire		
OPB705				0.160" Leads		
OPB705WZ			Aperture	Darlington	24" / 26 AWG Wire	
OPB70AWZ						
OPB70BWZ (Obsolete)						Blue Window
OPB70CWZ (Obsolete)						Aperture
OPB70DWZ			Transistor			
OPB70EWZ			Rbe Transistor			
OPB70FWZ	Transistor	Clear Window				



RoHS

General Note

TT Electronics reserves the right to make changes in product specification without notice or liability. All information is subject to TT Electronics' own data and is considered accurate at time of going to print.

TT Electronics | OPTEK Technology
 2900 E. Plano Pkwy, Plano, TX 75074 | Ph: +1 972 323 2200
 www.ttelectronics.com | sensors@ttelectronics.com

Reflective Object Sensor

OPB703 through OPB705,
 OPB703WZ through OPB705WZ,
 OPB70AWZ, OPB70DWZ, OPB70EWZ, OPB70FWZ



Obsolete (OPB70BWZ, OPB70CWZ, OPB70HWZ, OPB704G)

OPB703, OPB704, OPB705

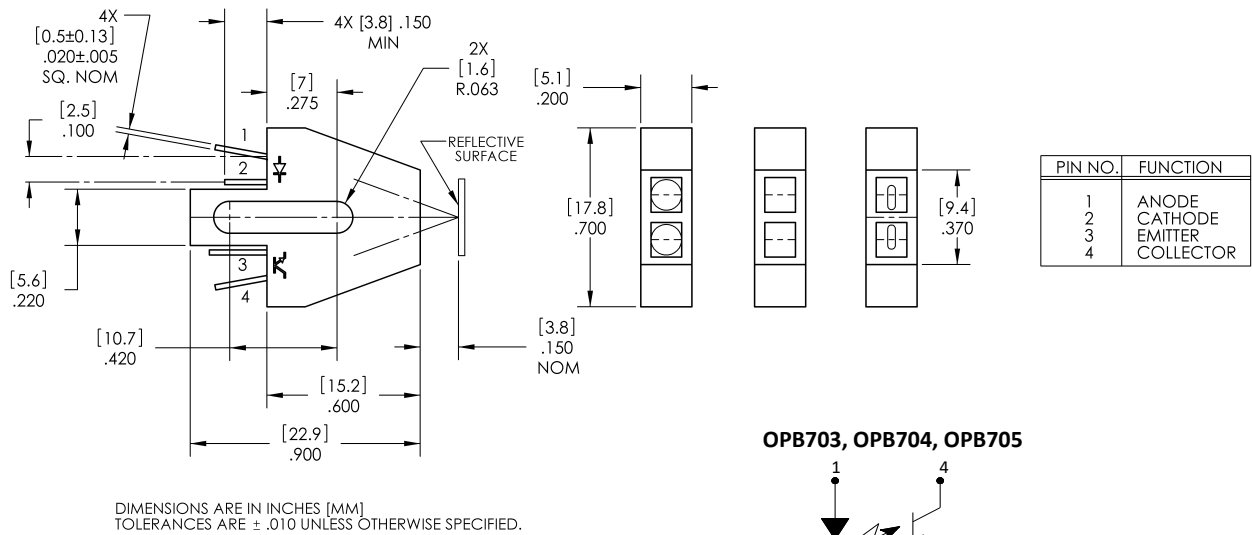

OPB703, OPB704, OPB705

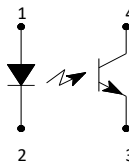

OPB703WZ, OPB704WZ, OPB705WZ, OPB70AWZ, OPB70DWZ

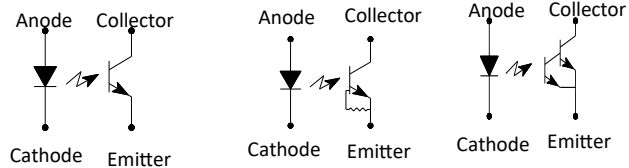
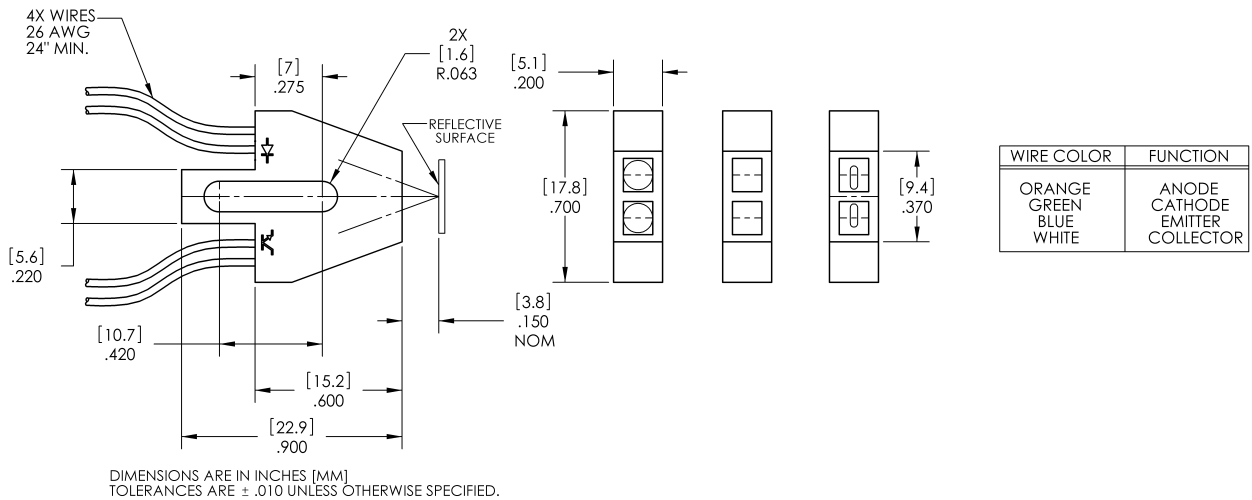

General Note

TT Electronics reserves the right to make changes in product specification without notice or liability. All information is subject to TT Electronics' own data and is considered accurate at time of going to print.

TT Electronics | OPTEK Technology
 2900 E. Plano Pkwy, Plano, TX 75074 | Ph: +1 972 323 2200
www.ttelectronics.com | sensors@ttelectronics.com

Reflective Object Sensor

OPB703 through OPB705,
 OPB703WZ through OPB705WZ,
 OPB70AWZ, OPB70DWZ, OPB70EWZ, OPB70FWZ
 Obsolete (OPB70BWZ, OPB70CWZ, OPB70HWZ, OPB704G)



OPB704GWZ

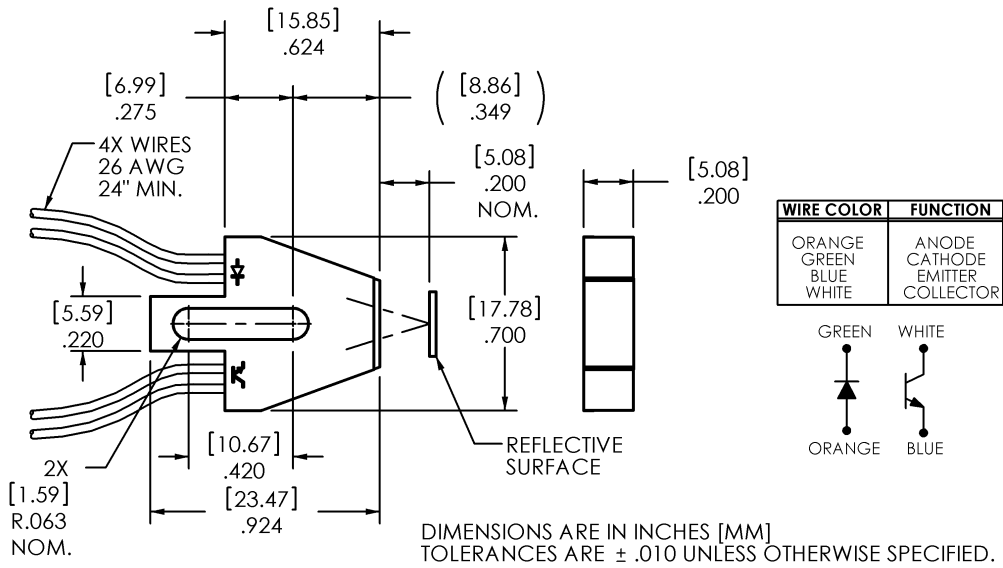

General Note
 TT Electronics reserves the right to make changes in product specification without notice or liability. All information is subject to TT Electronics' own data and is considered accurate at time of going to print.

TT Electronics | OPTEK Technology
 2900 E. Plano Pkwy, Plano, TX 75074 | Ph: +1 972 323 2200
 www.ttelectronics.com | sensors@ttelectronics.com

Reflective Object Sensor

OPB703 through OPB705,
OPB703WZ through OPB705WZ,
OPB70AWZ, OPB70DWZ, OPB70EWZ, OPB70FWZ
Obsolete (OPB70BWZ, OPB70CWZ, OPB70HWZ, OPB704G)



Electrical Specifications

Absolute Maximum Ratings ($T_A = 25^\circ\text{C}$ unless otherwise noted)

Storage Temperature Range	-40° C to +80° C
Lead Soldering Temperature [1/16 inch (1.6 mm) from the case for 5 sec. with soldering iron]	240° C ⁽¹⁾

Input Diode

Forward DC Current	40 mA
Reverse DC Voltage	2 V
Power Dissipation	100 mW ⁽²⁾

Output Photodetector

Collector-Emitter Voltage Phototransistor	30 V
Photodarlington	15 V
Emitter-Collector Voltage	5 V
Collector DC Current	25 mA
Power Dissipation	100 mW ⁽²⁾

Notes:

- (1) RMA flux is recommended. Duration can be extended to 10 seconds maximum when flow soldering.
- (2) For OPB703WZ, OPB704WZ, OPB705WZ and OPB704GWZ derate linearly 1.82 mW/° C above 25° C.

General Note

TT Electronics reserves the right to make changes in product specification without notice or liability. All information is subject to TT Electronics' own data and is considered accurate at time of going to print.

TT Electronics | OPTEK Technology
2900 E. Plano Pkwy, Plano, TX 75074 | Ph: +1 972 323 2200
www.ttelectronics.com | sensors@ttelectronics.com

Reflective Object Sensor

OPB703 through OPB705,
 OPB703WZ through OPB705WZ,
 OPB70AWZ, OPB70DWZ, OPB70EWZ, OPB70FWZ
 Obsolete (OPB70BWZ, OPB70CWZ, OPB70HWZ, OPB704G)



Electrical Specifications

Electrical Characteristics ($T_A = 25^\circ\text{C}$ unless otherwise noted)
 (OPB703, OPB703WZ, OPB704, OPB704WZ, OPB705, OPB705WZ, OPB704GWZ)

SYMBOL	PARAMETER	MIN	TYP	MAX	UNITS	TEST CONDITIONS
Input Diode						
V_F	Forward Voltage	-	-	1.7	V	$I_F = 40\text{ mA}$
I_R	Reverse Current	-	-	100	μA	$V_R = 2\text{ V}$
Output Phototransistor						
$V_{(BR)CEO}$	Collector-Emitter Breakdown Voltage	30	-	-	V	$I_{CE} = 100\ \mu\text{A}$
$V_{(BR)ECO}$	Emitter-Collector Breakdown Voltage	5	-	-	V	$I_{EC} = 100\ \mu\text{A}$
I_{CEO}	Collector Dark Current	-	-	250	nA	$V_{CE} = 10\text{ V}, I_F = 0, E_E = 0$
Coupled						
$I_{C(ON)}$	On-State Collector Current OPB703, OPB703WZ OPB704, OPB704WZ OPB705, OPB705WZ	0.30 0.20 0.15	- - -	2.5 2.5 1.0	mA	$V_{CE} = 5\text{ V}, I_F = 40\text{ mA}, d = 0.15''$ ⁽⁴⁾⁽⁶⁾
	OPB704GWZ	0.50	-	6.0		$V_{CE} = 5\text{ V}, I_F = 40\text{ mA}, d = 0.20''$ ⁽⁴⁾⁽⁶⁾
I_{CX}	Crosstalk	-	-	20	μA	$V_{CE} = 5\text{ V}, I_F = 40\text{ mA}$ ⁽⁵⁾
	OPB703, OPB703WZ	-	-	20		
	OPB704, OPB704WZ	-	-	10		
	OPB705, OPB705WZ OPB704GWZ	-	-	100		

Notes:

- (1) RMA flux is recommended. Duration can be extended to 10 seconds maximum when flow soldering.
- (2) For OPB703, OPB704 and OPB705, derate linearly 1.67 mW/ $^\circ\text{C}$ above 25 $^\circ\text{C}$.
- (3) For OPB703WZ, OPB704WZ, OPB705WZ, OPB704GWZ, OPB70AWZ, OPB70DWZ, OPB70EWZ, and OPB70FWZ derate linearly 1.82 mW/ $^\circ\text{C}$ above 25 $^\circ\text{C}$.
- (4) The distance from the assembly face to the reflective surface is d.
- (5) Crosstalk (I_{CX}) is the collector current measured with the indicated current in the input diode and with no reflecting surface.
- (6) Measured using Eastman Kodak neutral white test card with 90 % diffuse reflectance as a reflecting surface. Reference: Eastman Kodak, Catalog # E 152 7795.
- (7) All parameters tested using pulse techniques.

General Note

TT Electronics reserves the right to make changes in product specification without notice or liability. All information is subject to TT Electronics' own data and is considered accurate at time of going to print.

TT Electronics | OPTEK Technology
 2900 E. Plano Pkwy, Plano, TX 75074 | Ph: +1 972 323 2200
 www.ttelectronics.com | sensors@ttelectronics.com

Reflective Object Sensor

OPB703 through OPB705,
OPB703WZ through OPB705WZ,
OPB70AWZ, OPB70DWZ, OPB70EWZ, OPB70FWZ
Obsolete (OPB70BWZ, OPB70CWZ, OPB70HWZ, OPB704G)



Electrical Specifications

Electrical Characteristics ($T_A = 25^\circ\text{C}$ unless otherwise noted)
(OPB70AWZ)

SYMBOL	PARAMETER	MIN	TYP	MAX	UNITS	TEST CONDITIONS
Input Diode						
V_F	Forward Voltage	-	-	1.7	V	$I_F = 40\text{ mA}$
I_R	Reverse Current	-	-	100	μA	$V_R = 2\text{ V}$
Output PhotoDarlington						
$V_{(BR)CEO}$	Collector-Emitter Breakdown Voltage	15	-	-	V	$I_{CE} = 1.0\text{ mA}$, $E_E = 0$
$V_{(BR)ECO}$	Emitter-Collector Breakdown Voltage	5	-	-	V	$I_{EC} = 100\ \mu\text{A}$, $E_E = 0$
I_{CEO}	Collector Dark Current	-	-	250	nA	$V_{CE} = 10\text{ V}$, $I_F = 0$, $E_E = 0$
Coupled						
$I_{C(ON)}$	On-State Collector Current	5.0	-	26.0	mA	$V_{CE} = 5\text{ V}$, $I_F = 40\text{ mA}$, $d = 0.15''$ ⁽¹⁾⁽³⁾
$V_{(SAT)}$	Saturation Voltage	-	-	1.15	V	$I_{CV} = 400\ \mu\text{A}$, $I_F = 40\text{ mA}$, $d = 0.15''$ ⁽¹⁾⁽³⁾
I_{CX}	Crosstalk	-	-	25	μA	$V_{CE} = 5\text{ V}$, $I_F = 40\text{ mA}$ ⁽²⁾

Notes:

- (1) The distance from the assembly face to the reflective surface is d .
- (2) Crosstalk (I_{CX}) is the collector current measured with the indicated current in the input diode and with no reflecting surface.
- (3) Measured using Eastman Kodak neutral white test card with 90 % diffuse reflectance as a reflecting surface. Reference: Eastman Kodak, Catalog # E 152 7795.

General Note

TT Electronics reserves the right to make changes in product specification without notice or liability. All information is subject to TT Electronics' own data and is considered accurate at time of going to print.

TT Electronics | OPTEK Technology
2900 E. Plano Pkwy, Plano, TX 75074 | Ph: +1 972 323 2200
www.ttelectronics.com | sensors@ttelectronics.com

Reflective Object Sensor

OPB703 through OPB705,
OPB703WZ through OPB705WZ,
OPB70AWZ, OPB70DWZ, OPB70EWZ, OPB70FWZ
Obsolete (OPB70BWZ, OPB70CWZ, OPB70HWZ, OPB704G)



Electrical Specifications

Electrical Characteristics ($T_A = 25^\circ\text{C}$ unless otherwise noted)
(OPB70EWZ)

SYMBOL	PARAMETER	MIN	TYP	MAX	UNITS	TEST CONDITIONS
Input Diode						
V_F	Forward Voltage	-	-	2.6	V	$I_F = 40\text{ mA}$
I_R	Reverse Current	-	-	100	μA	$V_R = 2\text{ V}$
Output Phototransistor						
$V_{(BR)CEO}$	Collector-Emitter Breakdown Voltage	30	-	-	V	$I_{CE} = 100\ \mu\text{A}, I_F = 0, E_E = 0$
$V_{(BR)ECO}$	Emitter-Collector Breakdown Voltage	0.4	-	-	V	$I_{EC} = 100\ \mu\text{A}, I_F = 0, E_E = 0$
I_{CEO}	Collector Dark Current	-	-	100	nA	$V_{CE} = 10\text{ V}, I_F = 0, E_E = 0$

Coupled

$I_{C(ON)}$	On-State Collector Current	OPB70EWZ	.25	-	2.5	mA	$V_{CE} = 5\text{ V}, I_F = 40\text{ mA}, d = 0.15''^{(1)(3)}$
$V_{(SAT)}$	Saturation Voltage		-	-	0.4	V	$I_C = 100\ \mu\text{A}, I_F = 40\text{ mA}, d = 0.15''^{(1)(3)}$
I_{CX}	Crosstalk		-	-	2	μA	$V_{CE} = 5\text{ V}, I_F = 40\text{ mA}^{(2)}$

Notes:

- (1) The distance from the assembly face to the reflective surface is d .
- (2) Crosstalk (I_{CX}) is the collector current measured with the indicated current in the input diode and with no reflecting surface.
- (3) Measured using Eastman Kodak neutral white test card with 90 % diffuse reflectance as a reflecting surface. Reference: Eastman Kodak, Catalog # E 152 7795.

General Note

TT Electronics reserves the right to make changes in product specification without notice or liability. All information is subject to TT Electronics' own data and is considered accurate at time of going to print.

TT Electronics | OPTEK Technology
2900 E. Plano Pkwy, Plano, TX 75074 | Ph: +1 972 323 2200
www.ttelectronics.com | sensors@ttelectronics.com

Reflective Object Sensor

OPB703 through OPB705,
OPB703WZ through OPB705WZ,
OPB70AWZ, OPB70DWZ, OPB70EWZ, OPB70FWZ

Obsolete (OPB70BWZ, OPB70CWZ, OPB70HWZ, OPB704G)



Electrical Specifications

Electrical Characteristics ($T_A = 25^\circ\text{C}$ unless otherwise noted)
(OPB70DWZ and OPB70FWZ)

SYMBOL	PARAMETER	MIN	TYP	MAX	UNITS	TEST CONDITIONS
Input Diode						
V_F	Forward Voltage	-	-	2.6	V	$I_F = 40\text{ mA}$
I_R	Reverse Current	-	-	100	μA	$V_R = 2\text{ V}$
Output Phototransistor						
$V_{(BR)CEO}$	Collector-Emitter Breakdown Voltage	30	-	-	V	$I_{CE} = 100\ \mu\text{A}, I_F = 0, E_E = 0$
$V_{(BR)ECO}$	Emitter-Collector Breakdown Voltage	5.0	-	-	V	$I_{EC} = 100\ \mu\text{A}, I_F = 0, E_E = 0$
I_{CEO}	Collector Dark Current	-	-	250	nA	$V_{CE} = 10\text{ V}, I_F = 0, E_E = 0$

Coupled

$I_{C(ON)}$	On-State Collector Current	OPB70DWZ	.10	-	1.5	mA	$V_{CE} = 5\text{ V}, I_F = 40\text{ mA}, d = 0.15''^{(1)(3)}$
		OPB70FWZ	.25	-	3.5		
$V_{(SAT)}$	Saturation Voltage	-	-	0.4	V	$I_{C(ON)} = 100\ \mu\text{A}, I_F = 40\text{ mA}, d = 0.15''^{(1)(3)}$	
I_{CX}	Crosstalk	-	-	5.0	μA	$V_{CE} = 5\text{ V}, I_F = 40\text{ mA}^{(2)}$	

Notes:

- (1) The distance from the assembly face to the reflective surface is d.
- (2) Crosstalk (I_{CX}) is the collector current measured with the indicated current in the input diode and with no reflecting surface.
- (3) Measured using Eastman Kodak neutral white test card with 90 % diffuse reflectance as a reflecting surface. Reference: Eastman Kodak, Catalog # E 152 7795.

General Note

TT Electronics reserves the right to make changes in product specification without notice or liability. All information is subject to TT Electronics' own data and is considered accurate at time of going to print.

TT Electronics | OPTEK Technology
2900 E. Plano Pkwy, Plano, TX 75074 | Ph: +1 972 323 2200
www.ttelectronics.com | sensors@ttelectronics.com

Reflective Object Sensor

OPB703 through OPB705,
 OPB703WZ through OPB705WZ,
 OPB70AWZ, OPB70DWZ, OPB70EWZ, OPB70FWZ
 Obsolete (OPB70BWZ, OPB70CWZ, OPB70HWZ, OPB704G)



Performance

OPB703 - Output vs Distance

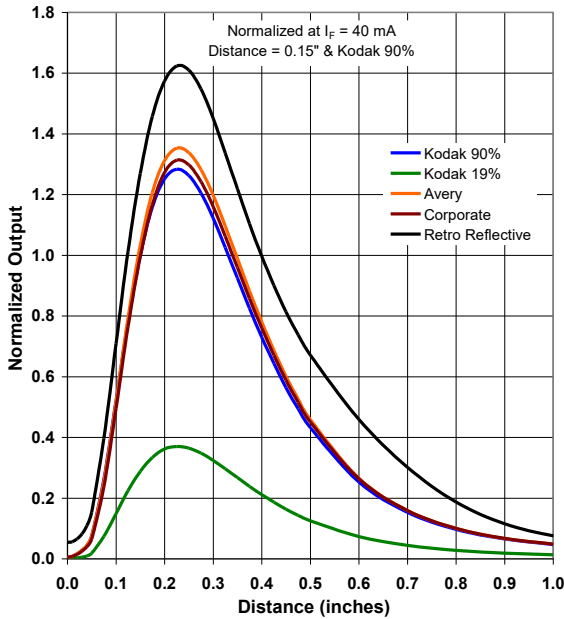

OPB704 - Output vs Distance

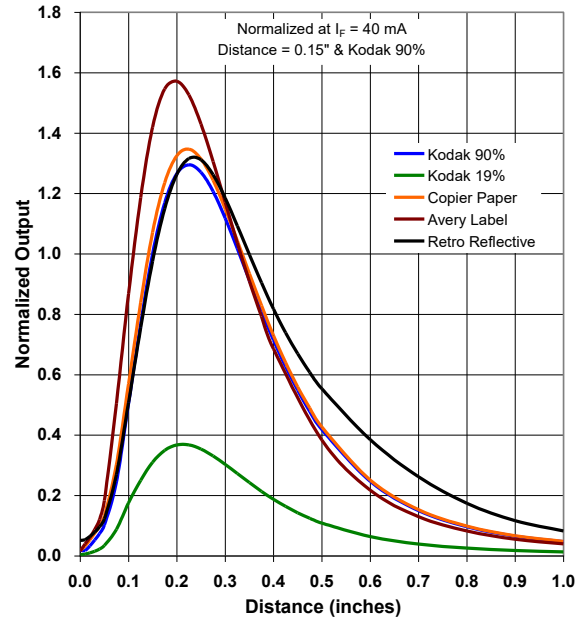

OPB705 - Output vs Distance

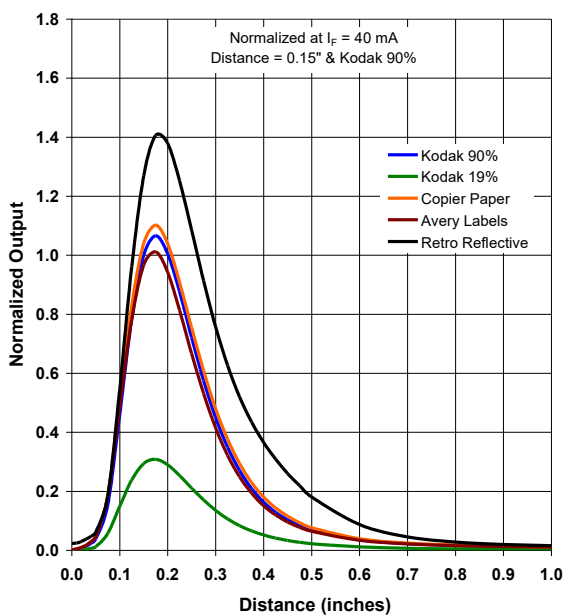

Forward Voltage vs Forward Current vs Temp

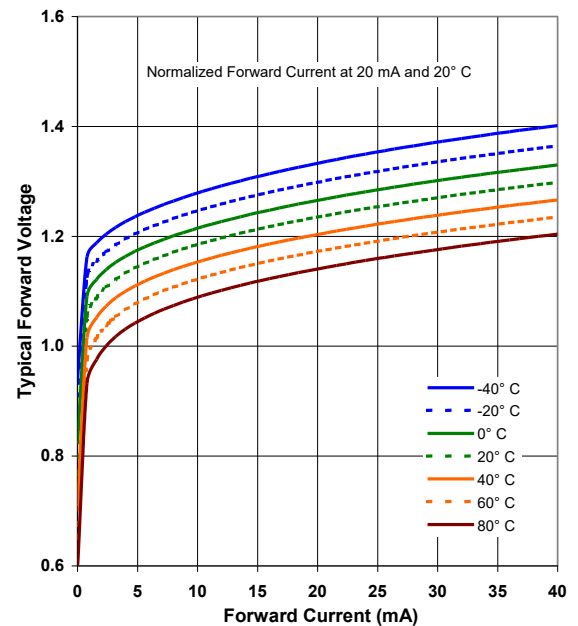

General Note

TT Electronics reserves the right to make changes in product specification without notice or liability. All information is subject to TT Electronics' own data and is considered accurate at time of going to print.

TT Electronics | OPTeK Technology
 2900 E. Plano Pkwy, Plano, TX 75074 | Ph: +1 972 323 2200
www.ttelectronics.com | sensors@ttelectronics.com