

Reflective Object Sensor



Type OPB733TR

Features:

- Unfocused for sensing diffuse surfaces
- Uses lensed devices for collimation of light beam
- Low-cost plastic housing
- Compact surface mount package 0.300" x 0.160" x 0.114" [7.6mmx4.1mmx2.9mm]
- Typical peak emission wavelength 890nm
- Reduced visible ambient light sensitivity
- Optimal operating distance range 0.4" [10.2mm] to 1.0" [25.4mm]



Description:

The **OPB733TR** consists of an 890nm, Infrared Light Emitting Diode (LED) and an NPN silicon Phototransistor, which are mounted "side-by-side" on parallel axes in a miniature surface mount grey plastic housing. The Phototransistor is molded in a grey epoxy package, which minimizes visible ambient light sensitivity. The phototransistor responds to radiation from the LED when a reflective object passes within its field of view. This unfocused reflective object sensor is ideal for non-contact detection of materials such as paper, labels, white plastic and many other reflective materials.

The OPB733TR sensors are packaged in 16mm tape on 7" [178mm] diameter reels, 500 pcs per reel. Tape and Reel package compatible with most automatic placement equipment.

Custom electrical, PCB assembly, wire and connectors are available. Contact your local OPTEK authorized representative or OPTEK for more information.

Applications:

- Assembly line automation
- ATM (Card Reader, Receipt Dispenser)
- Auto-dispense equipment
- Amusement equipment
- End-of-travel sensor
- Door sensor
- Edge detection
- Paper jam detection
- Mark detection
- Counters and sorters
- Proximity sensing
- Medical equipment
- Machine safety

Ordering Information	
Part Number	Description
OPB733TR	SMD Reflective Object Sensor

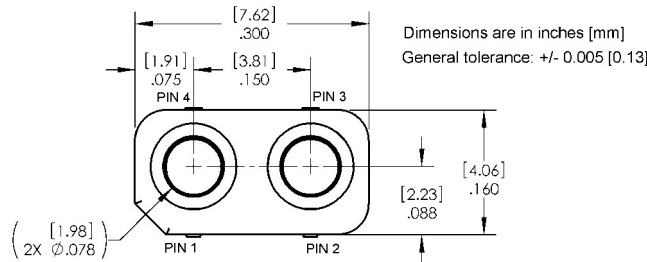

OPB733TR

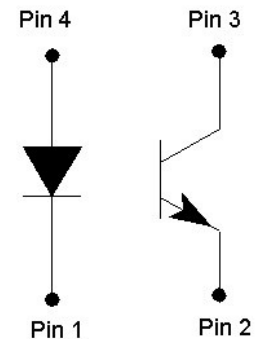

Pin #	Function
1	Cathode
2	Emitter
3	Collector
4	Anode

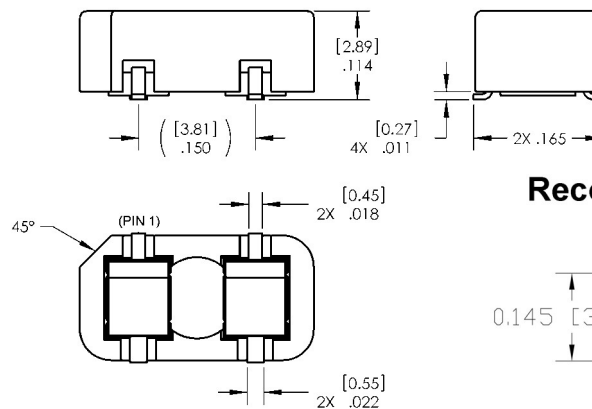

Recommended Solder Pad

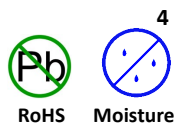
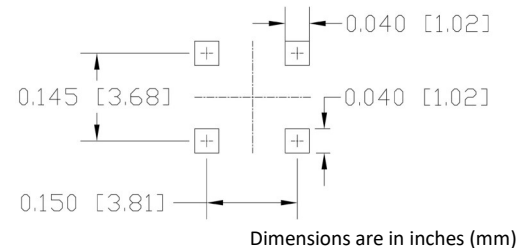

General Note

TT Electronics reserves the right to make changes in product specification without notice or liability. All information is subject to TT Electronics' own data and is considered accurate at time of going to print.

TT Electronics | OPTEK Technology
2900 E. Plano Pkwy, Plano, TX 75074 | Ph: +1 972 323 2200
www.ttelectronics.com | sensors@ttelectronics.com

Electrical Specifications

Absolute Maximum Ratings ($T_A = 25^\circ\text{C}$ unless otherwise noted)

Storage and Operating Temperature Range	-25° C to +85° C
Soldering Temperature. (see reflow solder temperature profile figure)	260° C
Input LED	
Forward DC Current	50 mA
Peak Forward Current (1 μs pulse width, 300 pps)	1 A
Reverse DC Voltage	5 V
Power Dissipation ⁽²⁾	130 mW
Output Phototransistor	
Collector-Emitter Voltage	30 V
Emitter-Collector Voltage	5 V
Collector DC Current	20 mA
Power Dissipation ⁽³⁾	75 mW

Electrical Characteristics ($T_A = 25^\circ\text{C}$ unless otherwise noted)

SYMBOL	PARAMETER	MIN	TYP	MAX	UNITS	TEST CONDITIONS
Input IR LED (see OP271 for additional information)						
V_F	Forward Voltage	-	-	1.7	V	$I_F = 20\text{ mA}$
I_R	Reverse Current	-	-	10	μA	$V_R = 5\text{ V}$
θ_{HP}	Emission angle at half power points	-	25	-	Degree	$I_F = 20\text{ mA}$
λ_P	Peak Emission Wavelength	-	890	-	nm	$I_F = 10\text{ mA}$
Output Phototransistor (see OP571 for additional information)						
$V_{(BR)CEO}$	Collector Emitter Breakdown Voltage	30	-	-	V	$I_C = 100\ \mu\text{A}$
$V_{(BR)ECO}$	Emitter Collector Breakdown Voltage	5	-	-	v	$I_E = 100\ \mu\text{A}$
I_{CEO}	Collector Dark Current	-	-	100	nA	$V_{CE} = 10\text{ V}, I_F = 0$
T_r	Rise Time	-	15	-	μs	$V_{CE} = 5\text{ Volts}^{(3)}$ $I_C = 1\text{ mA}$
T_f	Fall Time	-	15	-	μs	$R_L = 1\text{K}\Omega$
Coupled Characteristics						
$V_{CE(SAT)}$	Collector Emitter Saturation Voltage	-	-	0.4	V	$d = 0.5'' (12.7\text{ mm})^{(1)(2)}$ $I_C = 50\ \mu\text{A}, I_F = 20\text{ mA}$
$I_{C(ON)}$	On-State Collector Current	0.1	-	-	mA	$d = 0.5'' (12.7\text{ mm})^{(1)(2)}$ $I_F = 20\text{ mA}, V_{CE} = 5\text{ V}$

Notes:

- "d" is the distance from the assembly's top surface to the reflective surface.
- Measured using Eastman Kodak neutral white test card with 90% diffuse reflectance as a reflecting surface.
- By designed but not tested.
- Methanol or Isopropanol are recommended as cleaning agents. Plastic housing is soluble in chlorinated hydrocarbons and ketones.

General Note

TT Electronics reserves the right to make changes in product specification without notice or liability. All information is subject to TT Electronics' own data and is considered accurate at time of going to print.

Reflective Object Sensor

Type OPB733TR



Typical Performance Curves

LED Maximum Forward Current Vs Ambient Temperature

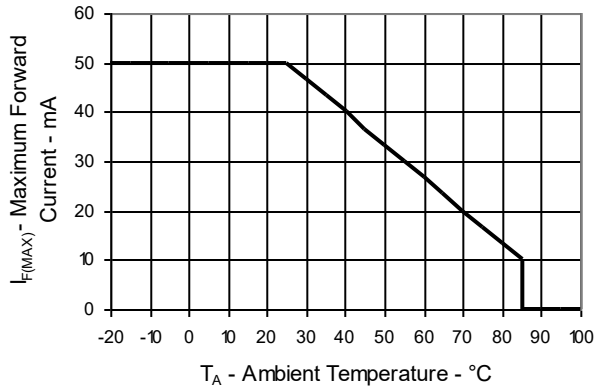

Phototransistor Collector Power Dissipation Vs Ambient Temperature

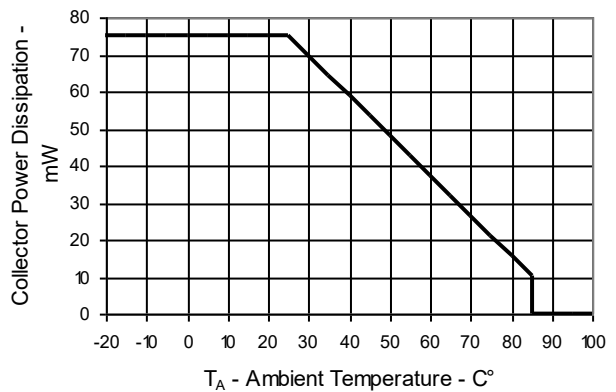

LED Forward Voltage Vs Forward Current

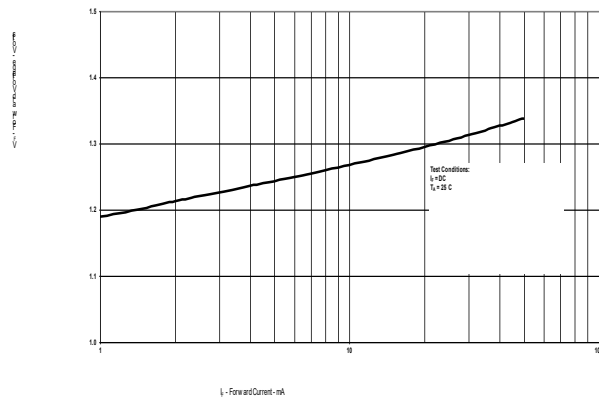

LED Relative Radiant Intensity Vs Angular Displacement

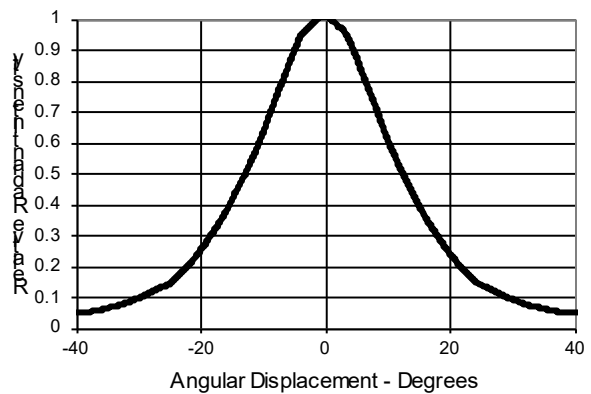

Phototransistor Relative Spectral Response Vs Wavelength

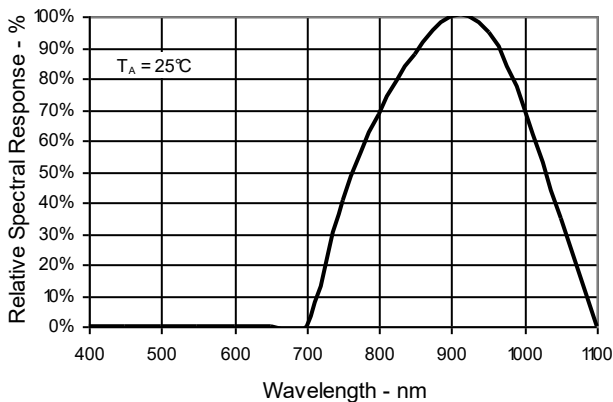

Normalized Collector Current Vs LED Forward Current

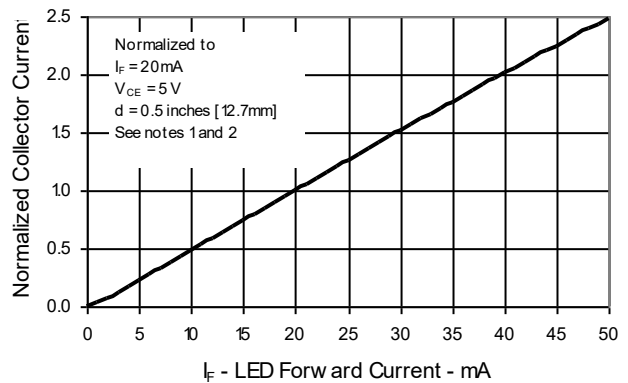

General Note

TT Electronics reserves the right to make changes in product specification without notice or liability. All information is subject to TT Electronics' own data and is considered accurate at time of going to print.

TT Electronics | OPTEK Technology
 2900 E. Plano Pkwy, Plano, TX 75074 | Ph: +1 972 323 2200
 www.ttelectronics.com | sensors@ttelectronics.com

Reflective Object Sensor

Type OPB733TR



Typical Performance Curves

Forward Voltage Vs Ambient Temperature

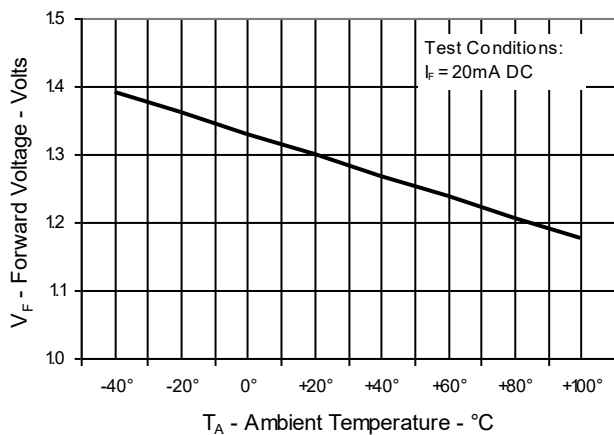

Normalized Collector Current Vs Ambient Temperature

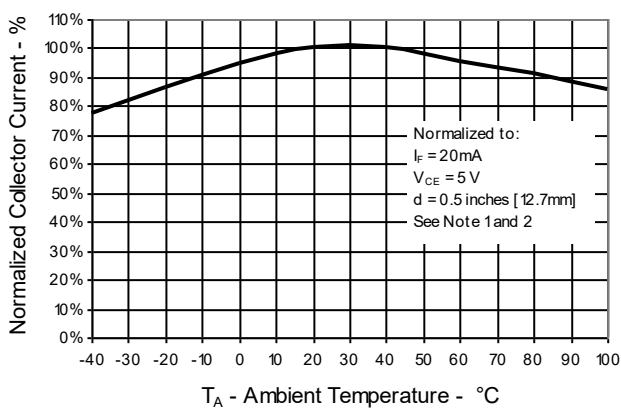

Normalized Collector Current Vs Object Distance

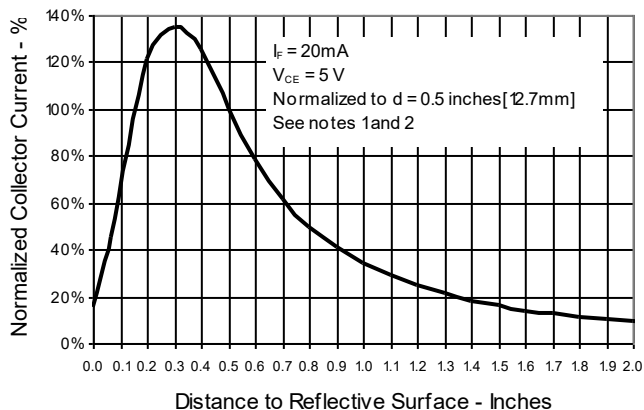

General Note

TT Electronics reserves the right to make changes in product specification without notice or liability. All information is subject to TT Electronics' own data and is considered accurate at time of going to print.

TT Electronics | OPTEK Technology
2900 E. Plano Pkwy, Plano, TX 75074 | Ph: +1 972 323 2200
www.ttelectronics.com | sensors@ttelectronics.com

Reflective Object Sensor

Type OPB733TR



Soldering Method:

- Reflow soldering profile shown below. Soldering should not exceed this curve in temperature and time.
- Avoid soldering more than once.
- Avoid exerting any type of pressure on the optical lenses and contact leads before, during, and after soldering.

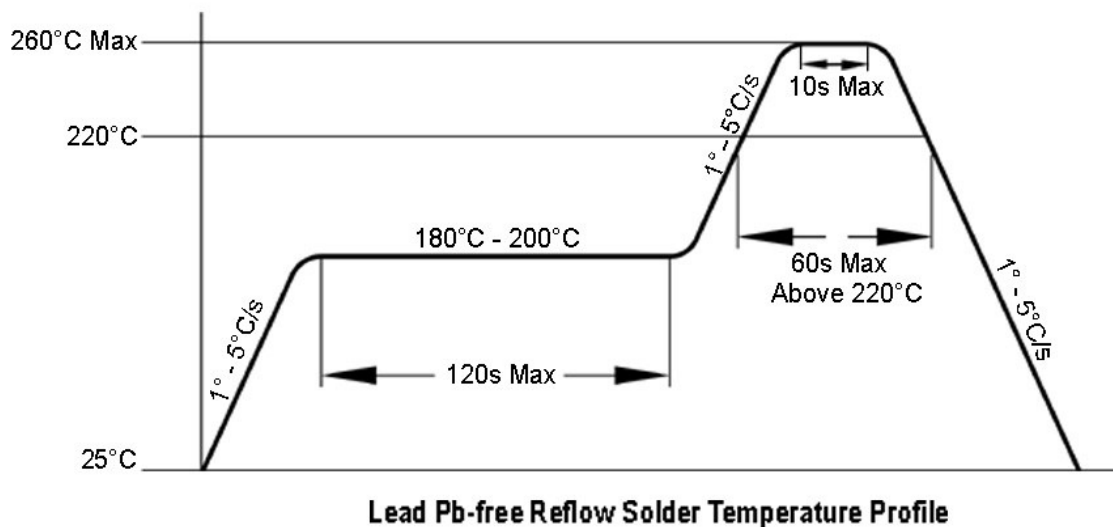

Storage:

- Storage temperature and relative humidity (R.H.) conditions are: 5°C to 30°C and 70% R.H. or less.
- Moisture proof bag should be open only if devices are ready to be used. Devices should be utilized within 72 hours after package has been opened.
- After opening the package, devices should be kept at a temperature of 5°C to 30°C and 60% R.H. or less.
- If the devices have exceeded the storage time or the humidity card indicates 60% relative humidity level, all devices should go through a baking treatment outside the original package prior to usage. Baking treatment: 60°C +/- 5°C for 24 hours.