

# Slotted Optical Switch

Series: OPB355T, OPB360, OPB370, OPB380  
OPB859, OPB860, OPB870, OPB880, OPB890

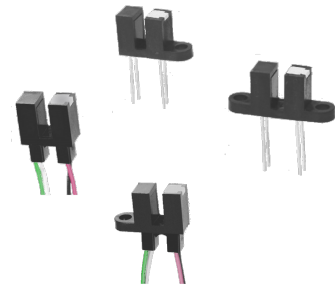

## Features:

- 0.125" (3.175 mm) slot width
- Choice of aperture (0.050" or 0.010" width)
- Choice of opaque or IR transmissive shell material
- Choice of mounting configurations
- Choice of lead spacing or wires

## Description:

The slotted optical sensors in this series provide the flexibility of a custom device from a standard product line.

Building from a standard housing with a 0.125" (3.18mm) wide slot, the user can specify output logic state, output driver circuit, aperture width, aperture surface and mounting tab locations. Furthermore, an option of wire or PCB leads allows electrical interface flexibility.

The device body is an opaque plastic which minimizes sensitivity to both visible and near-infrared external light sources which may impact operation. Aperture width choices provide different optical resolution for motion sensing. A covered aperture provides dust protection, while an open aperture provides maximum protection against external light sources.

Phototransistor sensor devices are: OPB360, OPB370, OPB380, OPB390, OPB859, OPB860, OPB870, OPB880, OPB890. The OPB355T provides a photodiode detector, which has a lower linear output-versus-light.

Wide electrical output current ranges are available. LED emissions are near-infrared (850-940 nm).

Custom electrical, wire and cabling services are available.  
Contact your local representative or OPTEK for more information.  
Compliant to EU RoHS Directive 2002/95/EC.

## Applications:

- Non-contact object sensing
- Assembly line automation
- Machine automation
- Equipment safety
- Machine safety

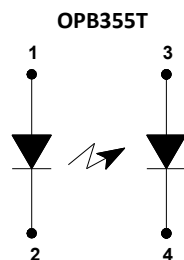

OPB360, OPB370, OPB380, OPB390  
OPB859  
OPB860, OPB870, OPB880, OPB890

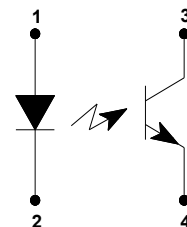

Wire Colors	
Color #	Description
1	Red
2	Black
3	White
4	Green

**CONTAINS POLYSULFONE**

To avoid stress cracking, we suggest using ND Industries' **Vibra-Tite** for thread-locking. **ND Vibra-Tite Formula 3** evaporates fast without causing structural failure in OPTEK's molded plastics.

**Applies to: OPB360, OPB370, OPB380, OPB390 and OPB860, OPB870, OPB880, OPB890.**



General Note  
TT Electronics reserves the right to make changes in product specification without notice or liability. All information is subject to TT Electronics' own data and is considered accurate at time of going to print.

TT Electronics | OPTEK Technology  
2900 E. Plano Pkwy, Plano, TX 75074 | Ph: +1 972 323 2200  
www.ttelectronics.com | sensors@ttelectronics.com

# Slotted Optical Switch

Series: OPB355T, OPB360, OPB370, OPB380

OPB859, OPB860, OPB870, OPB880, OPB890



## Part Number Guide (see active part number list) — OPB355

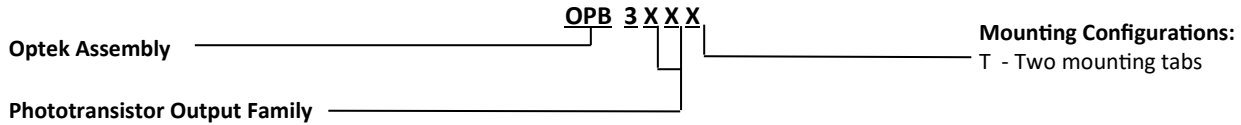

## Part Number Guide (see active part number list) — OPB360 / OPB370

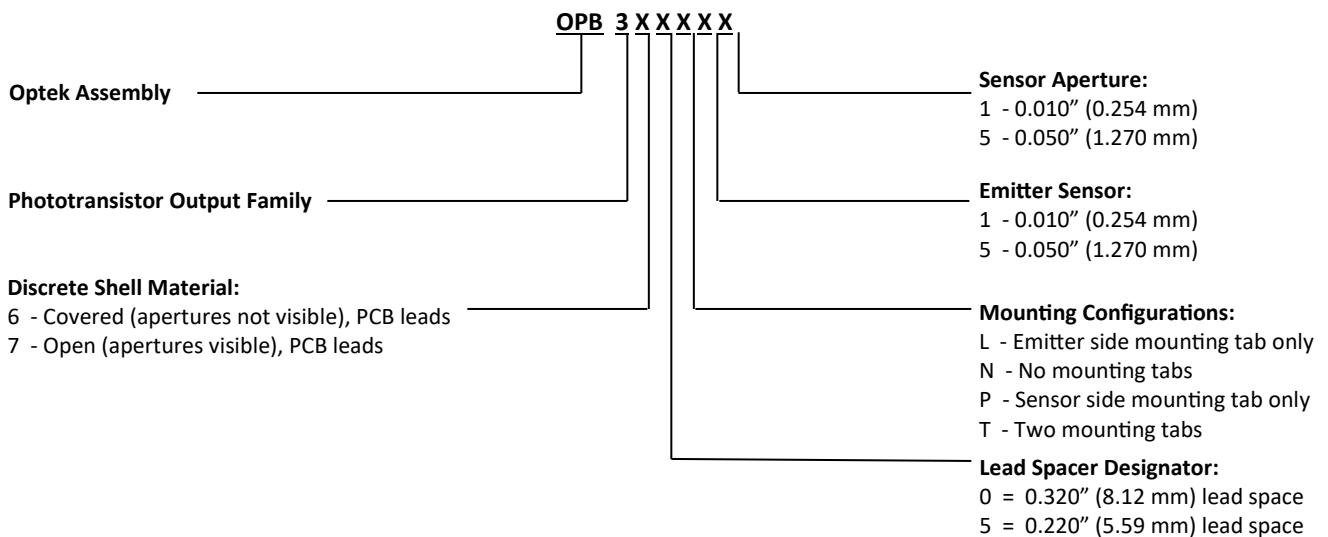

## Part Number Guide (see active part number list) — OPB380 / OPB390

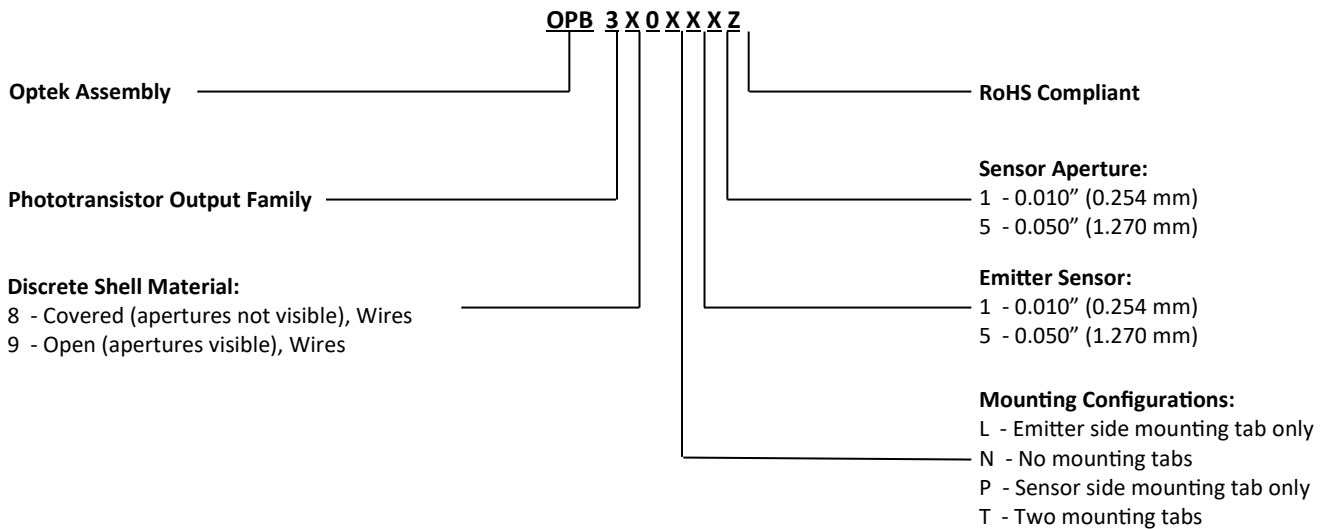

General Note  
TT Electronics reserves the right to make changes in product specification without notice or liability. All information is subject to TT Electronics' own data and is considered accurate at time of going to print.

# Slotted Optical Switch

Series: OPB355T, OPB360, OPB370, OPB380

OPB859, OPB860, OPB870, OPB880, OPB890



## Part Number Guide — OPB859

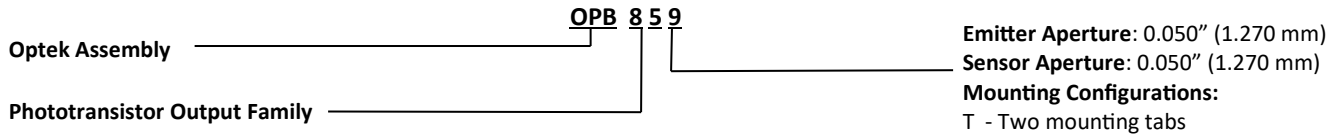

## Part Number Guide (see active part number list) — OPB860 / OPB870

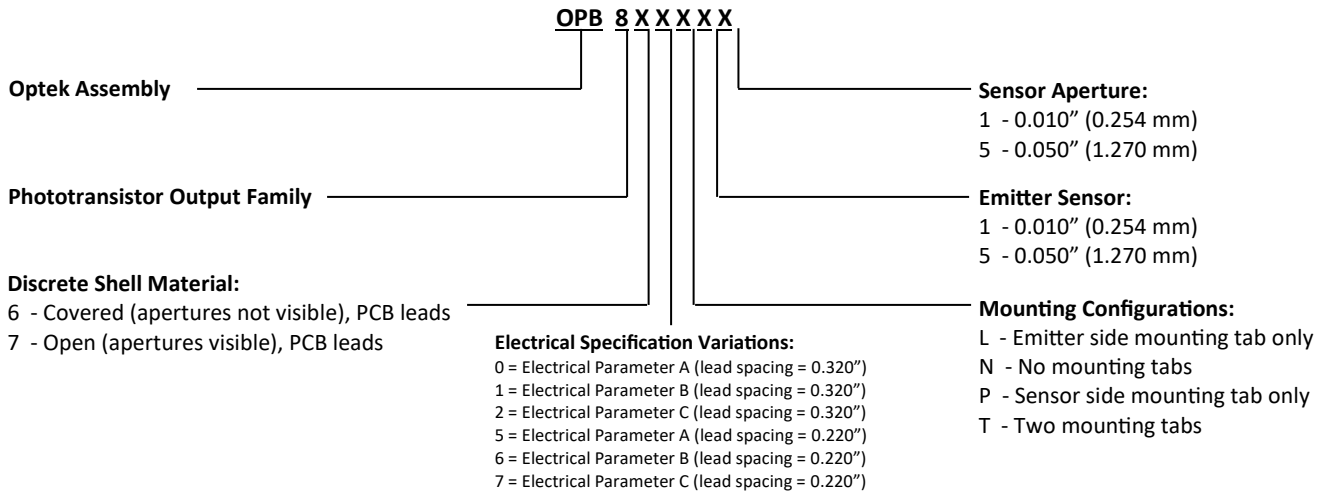

Note: Assemblies with dual 0.010" apertures are currently available with electrical parameter "A" only.

## Part Number Guide (see active part number list) — OPB880 / OPB890

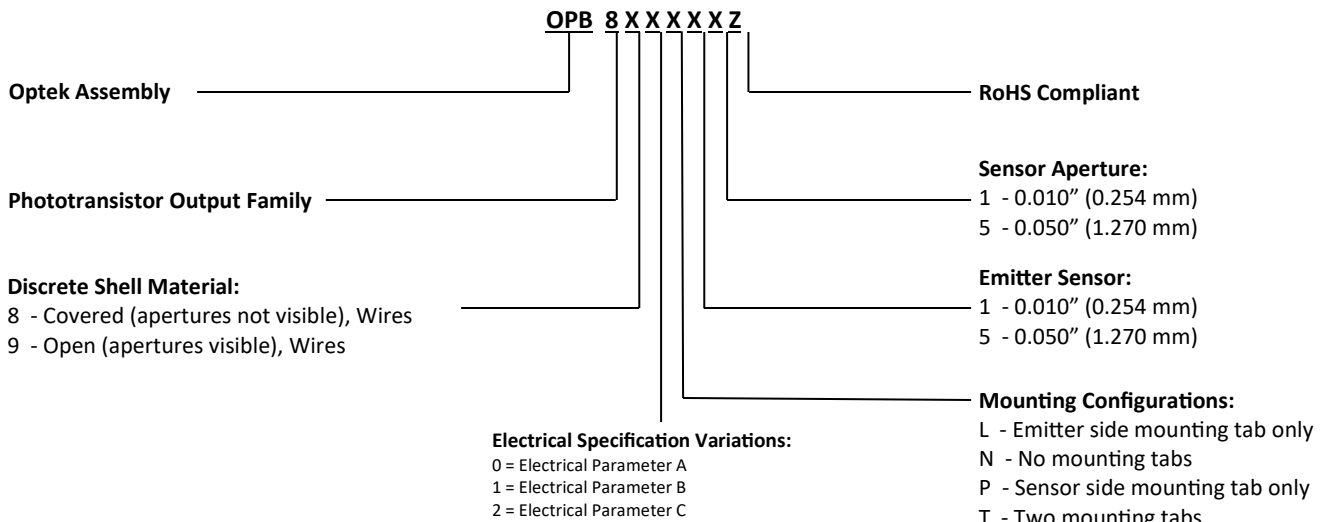

NOTE: Assemblies with dual 0.010" apertures are currently available with electrical parameter "A" only. Wires = 26AWG - 24" long. UL approved.

General Note  
TT Electronics reserves the right to make changes in product specification without notice or liability. All information is subject to TT Electronics' own data and is considered accurate at time of going to print.

TT Electronics | OPTEK Technology  
2900 E. Plano Pkwy, Plano, TX 75074 | Ph: +1 972 323 2200  
www.ttelectronics.com | sensors@ttelectronics.com

# Slotted Optical Switch

Series: OPB355T, OPB360, OPB370, OPB380

OPB859, OPB860, OPB870, OPB880, OPB890



Active Part Number List			
OPB355T	OPB380L55Z	OPB865N51	OPB880N55Z
OPB360L11	OPB380N11Z	OPB865T11	OPB880P51Z
OPB360L51	OPB380P51Z	OPB865T51	OPB880P55Z
OPB360L55	OPB380P55Z	OPB865T55	OPB880T11Z
OPB360N51	OPB380T11Z	OPB866P55	OPB880T51Z
OPB360T51	OPB380T51Z	OPB866T51	OPB880T55Z
OPB360T55	OPB380T55Z	OPB866T55	OPB881L51Z
OPB365L51	OPB390L11Z	OPB867T55	OPB881L55Z
OPB365N11	OPB390L51Z	OPB870N11	OPB881T51Z
OPB365N51	OPB390L55Z	OPB870N51	OPB881T55Z
OPB365N55	OPB390P11Z	OPB870N55	OPB882T51Z
OPB365P55	OPB390P51Z	OPB870P55	OPB882T55Z
OPB365T55	OPB390P55Z	OPB870T51	OPB890L11Z
OPB370L55	OPB390T11Z	OPB871N51	OPB890P11Z
OPB370N51	OPB390T51Z	OPB871N55	OPB890P51Z
OPB370N55	OPB390T55Z	OPB871T55	OPB890P55Z
OPB370T11	OPB859	OPB872T55	OPB890T11Z
OPB370T51	OPB860N51	OPB875N51	OPB890T51Z
OPB370T55	OPB860N55	OPB876N55	OPB890T55Z
OPB375L11	OPB860T11	OPB876T55	OPB891P55Z
OPB375N51	OPB861N55	OPB877N55	OPB891T51Z
OPB375T11	OPB861T55	OPB877T55	OPB891T55Z
OPB375T55	OPB862T51	OPB880L51Z	OPB892L51Z
OPB380L51Z	OPB865N11	OPB880N11Z	OPB892T55Z

#### General Note

TT Electronics reserves the right to make changes in product specification without notice or liability. All information is subject to TT Electronics' own data and is considered accurate at time of going to print.

TT Electronics | OPTEK Technology  
2900 E. Plano Pkwy, Plano, TX 75074 | Ph: +1 972 323 2200  
[www.ttelectronics.com](http://www.ttelectronics.com) | [sensors@ttelectronics.com](mailto:sensors@ttelectronics.com)

# Slotted Optical Switch

Series: OPB355T, OPB360, OPB370, OPB380



OPB859, OPB860, OPB870, OPB880, OPB890

## OPB355, OPB360, OPB370

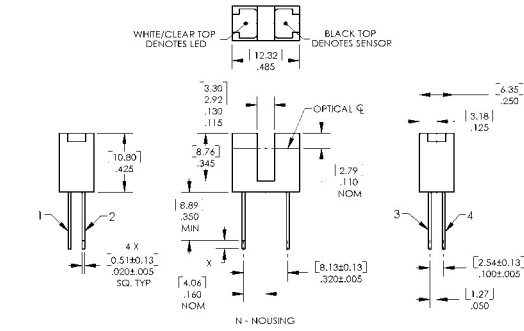

## OPB380, OPB390

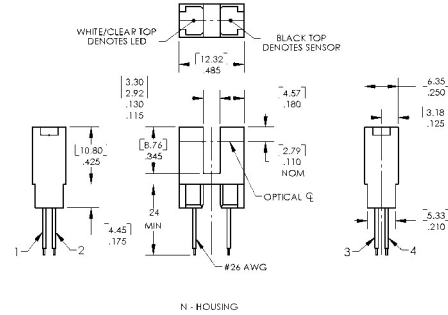

DIMENSIONS ARE IN INCHES AND MILLIMETERS  
TOLERANCES ARE ± .010" [.25].

## OPB859

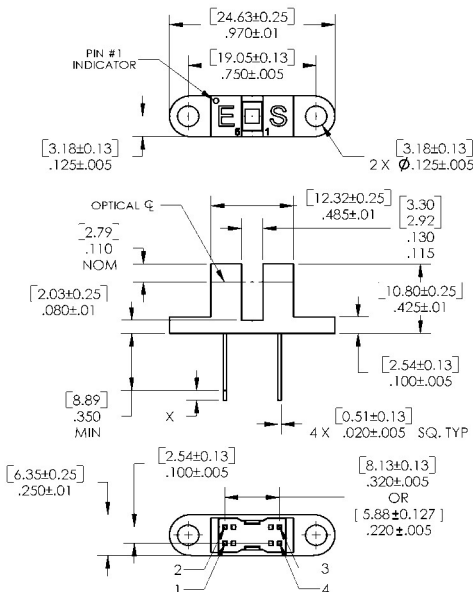

Pin #	Emitter	Pin #	Transistor/Diode
1	Anode	3	Collector / Anode
2	Cathode	4	Emitter / Cathode

## OPB880, OPB890

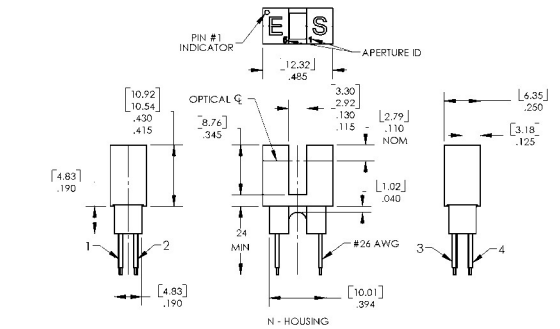

DIMENSIONS ARE IN: [ MILLIMETERS ]  
INCHES

### General Note

TT Electronics reserves the right to make changes in product specification without notice or liability. All information is subject to TT Electronics' own data and is considered accurate at time of going to print.

TT Electronics | OPTEK Technology  
2900 E. Plano Pkwy, Plano, TX 75074 | Ph: +1 972 323 2200  
www.ttelectronics.com | sensors@ttelectronics.com

# Slotted Optical Switch

Series: OPB355T, OPB360, OPB370, OPB380

OPB859, OPB860, OPB870, OPB880, OPB890



## OPB860, OPB870

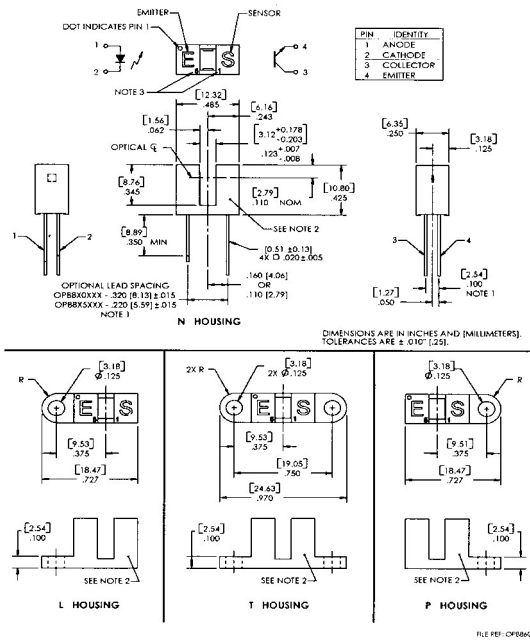

### General Note

TT Electronics reserves the right to make changes in product specification without notice or liability. All information is subject to TT Electronics' own data and is considered accurate at time of going to print.

TT Electronics | OPTEK Technology  
 2900 E. Plano Pkwy, Plano, TX 75074 | Ph: +1 972 323 2200  
 www.ttelectronics.com | sensors@ttelectronics.com

# Slotted Optical Switch

Series: OPB355T, OPB360, OPB370, OPB380

OPB859, OPB860, OPB870, OPB880, OPB890



## Electrical Specifications

**Absolute Maximum Ratings** ( $T_A = 25^\circ\text{C}$  unless otherwise noted)

Storage Temperature <sup>(1) (2)</sup> OPB355T, OPB360, OPB370, OPB859, OPB860, OPB870 Series OPB380, OPB390, OPB880, OPB890 Series	-40° C to +100° C -40° C to +85° C
Operating Temperature <sup>(1) (2)</sup>	-40° C to +85° C
Lead Soldering Temperature <sup>(7)</sup>	260° C
<b>Input LED</b>	
Forward DC Current OPB355T, OPB360, OPB370, OPB380, OPB390, OPB859, OPB860, OPB870, OPB880, OPB890	50 mA
Peak Forward Current (1 $\mu\text{s}$ pulse width, 300 pps)	1 A
Reverse DC Voltage	2 V
Power Dissipation <sup>(2)</sup>	75 mW
<b>Output Phototransistor/Diode</b>	
Cathode-Anode Reverse Voltage -OPB355T	60 V
Collector-Emitter Voltage OPB360, OPB370, OPB380, OPB390, OPB859, OPB860, OPB870, OPB880, OPB890 Series	30 V
Emitter-Collector Voltage	5 V
Collector DC Current	30 mA
Power Dissipation <sup>(1)</sup>	100 mW

Notes:

- (1) For wire series (OPB380, OPB390, OPB880 and OPB890), maximum storage and operating temperature is limited by the temperature rating of the lead wires.
- (2) Derate linearly 1.67 mW/° C above 25° C.
- (3) For OPB355T, OPB360 and OPB370, polarity is denoted by color of housing top: LED (clear); sensor (black).
- (4) Cleaning agents methanol and isopropanol are recommended. Spray or wipe; do not submerge.
- (5) OPB380 and OPB390 wire terminations have 24" of 7-strand 26 AWG UL approved insulated wire on each terminal. These devices incorporate a wire strain relief at the housing surface. The insulation colors and functions are: IRED anode (red); IRED cathode (black); phototransistor collector (white); phototransistor emitter (green).
- (6) RMA flux is recommended. Duration can be extended to 10 seconds maximum when flow soldering.
- (7) All parameters were tested using pulse technique.

### General Note

TT Electronics reserves the right to make changes in product specification without notice or liability. All information is subject to TT Electronics' own data and is considered accurate at time of going to print.

TT Electronics | OPTEK Technology  
2900 E. Plano Pkwy, Plano, TX 75074 | Ph: +1 972 323 2200  
www.ttelectronics.com | sensors@ttelectronics.com

# Slotted Optical Switch

Series: OPB355T, OPB360, OPB370, OPB380



OPB859, OPB860, OPB870, OPB880, OPB890

Electrical Characteristics ( $T_A = 25^\circ\text{C}$ unless otherwise noted)						
SYMBOL	PARAMETER	MIN	TYP	MAX	UNITS	TEST CONDITIONS
<b>Input Transistor/Diode</b>						
$V_F$	Forward Voltage	-	1.3	1.8	V	$I_F = 20\text{ mA}$
$I_R$	Reverse Current	-	-	100	$\mu\text{A}$	$V_R = 2\text{ V}$
<b>Output Diode — OPB355T</b>						
$V_{BR}$	Reverse Diode Breakdown Voltage	60	-	-	V	$I_R = 100\ \mu\text{A}$ , $I_F = 0$ , $E_E = 0$
$V_{FD}$	Forward Voltage Photodiode	-	-	1.2	V	$I_F = 1\text{ mA}$ , $I_F = 0$ , $E_E = 0$
ID	Reverse Dark Current	-	-	60	nA	$V_R = 30\text{ V}$ , $E_E = 0$ , $I_F = 0$
<b>Output Transistor</b>						
$V_{(BR)CEO}$	Collector-Emitter Breakdown Voltage	30	-	-	V	$I_C = 1\text{ mA}$
$V_{(BR)ECO}$	Emitter-Collector Breakdown Voltage	5	-	-	V	$I_E = 100\ \mu\text{A}$
$I_{CEO}$	Collector-Emitter Dark Current	-	-	100	nA	$V_{CE} = 10\text{ V}$ , $I_F = 0$ , $E_E = 0$
<b>Coupled</b>						
$I_L$	On-State Collector Current OPB355T	10	-	200	$\mu\text{A}$	$V_R = 5\text{ V}$ , $I_F = 40\text{ mA}$
$V_{CE(SAT)}$	Collector-Emitter Saturation Voltage OPB859 OPB860/870/865/875 (Para. A) OPB861/871/866/876 (Para. B) OPB862/872/867/877 (Para. C) OPB880/890/ (Para. A) OPB881/891 (Para. B) OPB882/892 (Para. C)	- - - - - - -	- - - - - - -	0.4 0.4 0.4 0.6 0.4 0.4 0.6	V	$I_C = 125\ \mu\text{A}$ , $I_F = 20\text{ mA}$ $I_C = 400\ \mu\text{A}$ , $I_F = 20\text{ mA}$ $I_C = 800\ \mu\text{A}$ , $I_F = 20\text{ mA}$ $I_C = 1800\ \mu\text{A}$ , $I_F = 20\text{ mA}$ $I_C = 400\ \mu\text{A}$ , $I_F = 20\text{ mA}$ $I_C = 800\ \mu\text{A}$ , $I_F = 10\text{ mA}$ $I_C = 1800\ \mu\text{A}$ , $I_F = 20\text{ mA}$
$I_{C(ON)}$	On-State Collector Current OPB36X, OPB37X (T, N, L, P 11) OPB36X, OPB37X (T, N, L, P 51) OPB36X, OPB37X (T, N, L, P 55) OPB38X, OPB39X (T, N, L, P 11) OPB38X, OPB39X (T, N, L, P 51) OPB38X, OPB39X (T, N, L, P 55)	1.0 2.5 3.5 1.0 2.5 3.5	- - - - - -	5 10 14 5 10 14	mA	$V_{CE} = 0.4\text{ V}$ , $I_F = 20\text{ mA}$
	OPB859	250	-	-	$\mu\text{A}$	$V_{CE} = 10\text{ V}$ , $I_F = 20\text{ mA}$
	OPB860/870/865/875 (Para. A) OPB861/871/866/876 (Para. B) OPB862/872/867/877 (Para. C) OPB880/890/ (Para. A) OPB881/891 (Para. B) OPB882/892 (Para. C)	0.5 1.0 1.8 0.5 1.0 1.8	- - - - - -	- - - - - -	mA	$V_{CE} = 10\text{ V}$ , $I_F = 20\text{ mA}$ $V_{CE} = 5\text{ V}$ , $I_F = 10\text{ mA}$ $V_{CE} = 0.6\text{ V}$ , $I_F = 20\text{ mA}$ $V_{CE} = 10\text{ V}$ , $I_F = 20\text{ mA}$ $V_{CE} = 5\text{ V}$ , $I_F = 10\text{ mA}$ $V_{CE} = 0.6\text{ V}$ , $I_F = 20\text{ mA}$

**General Note**

TT Electronics reserves the right to make changes in product specification without notice or liability. All information is subject to TT Electronics' own data and is considered accurate at time of going to print.

TT Electronics | OPTEK Technology  
2900 E. Plano Pkwy, Plano, TX 75074 | Ph: +1 972 323 2200  
www.ttelectronics.com | sensors@ttelectronics.com



# Slotted Optical Switch

Series: OPB355T, OPB360, OPB370, OPB380



OPB859, OPB860, OPB870, OPB880, OPB890

OPB355 - Flag Next to Emitter

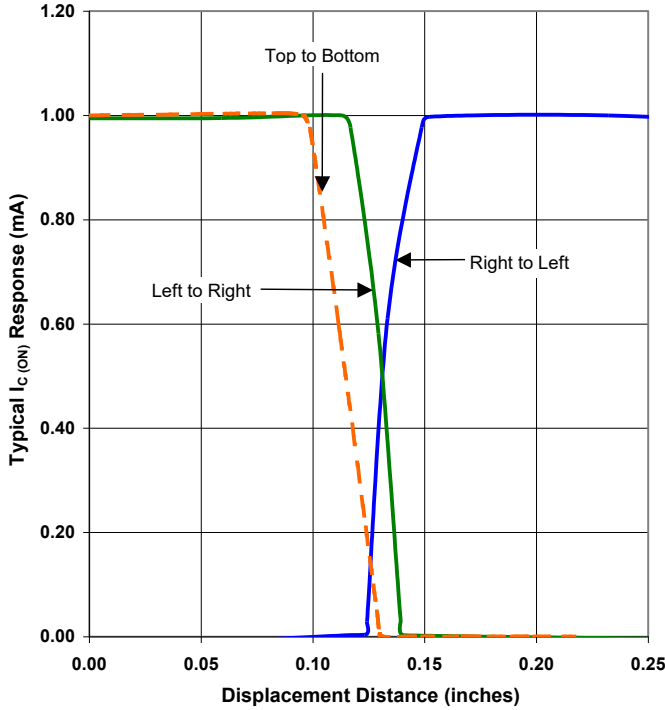

OPB355 - Flag Next to Sensor

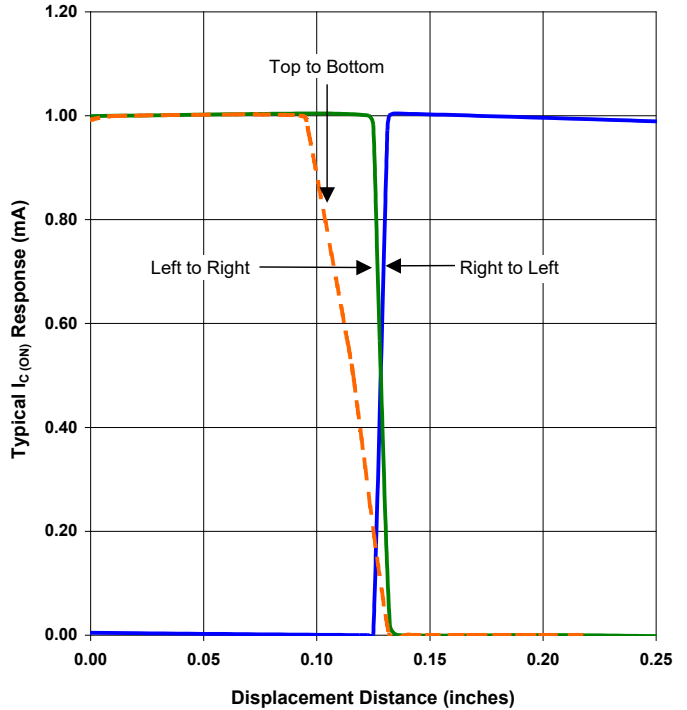

OPB355 - Flag in Middle of Slot

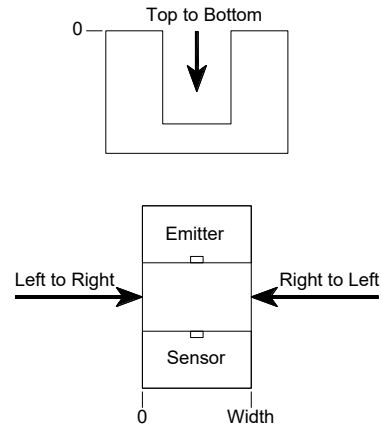
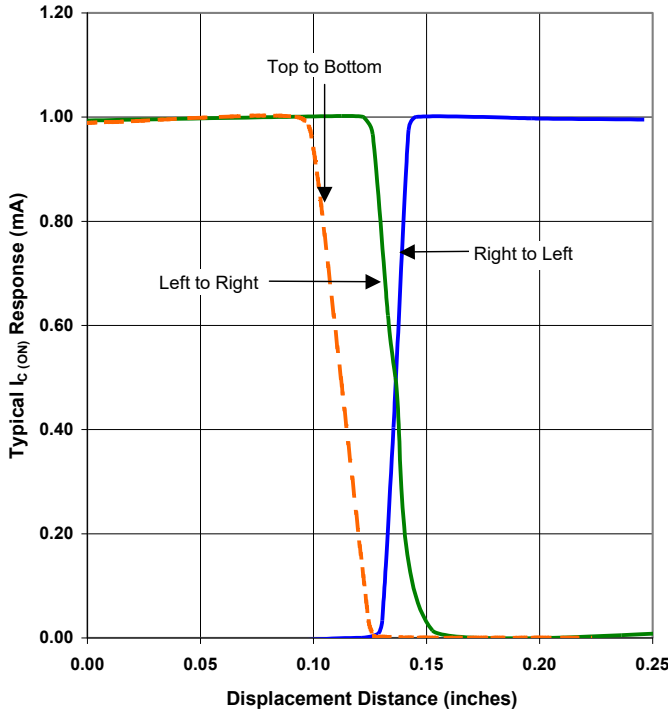

General Note

TT Electronics reserves the right to make changes in product specification without notice or liability. All information is subject to TT Electronics' own data and is considered accurate at time of going to print.

TT Electronics | OPTEK Technology  
 2900 E. Plano Pkwy, Plano, TX 75074 | Ph: +1 972 323 2200  
 www.ttelectronics.com | sensors@ttelectronics.com

# Slotted Optical Switch

Series: OPB355T, OPB360, OPB370, OPB380



OPB859, OPB860, OPB870, OPB880, OPB890

Aperture Configuration 11 - Flag Next to Emitter

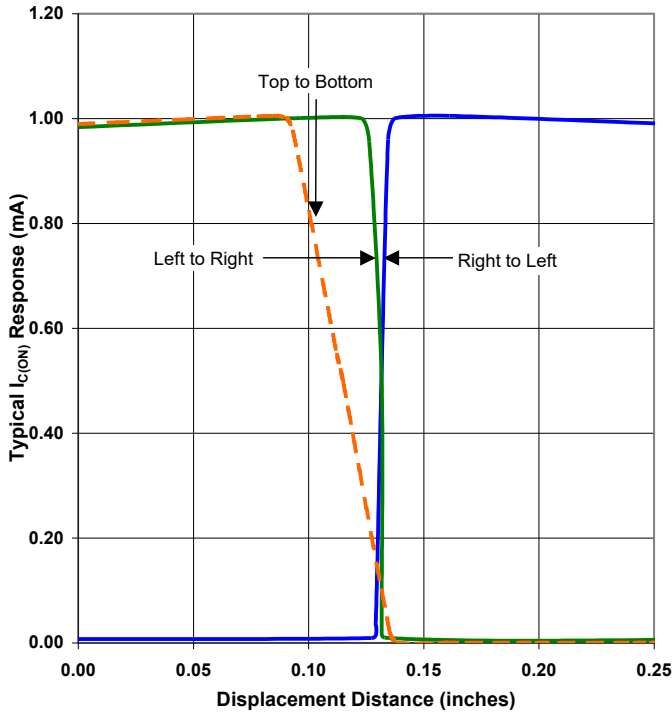

Aperture Configuration 11 - Flag Next to Sensor

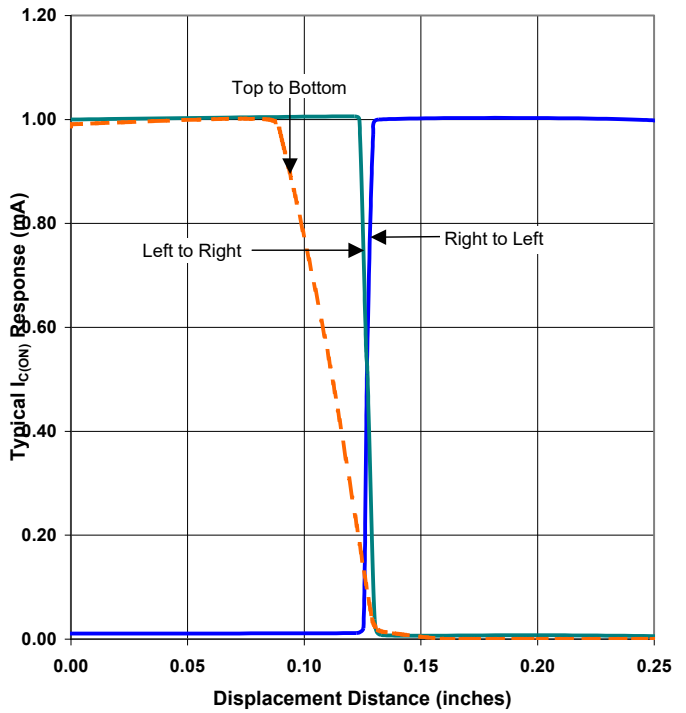

Aperture Configuration 11 - Flag in Middle of Slot

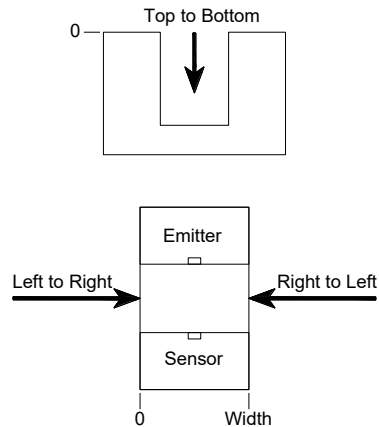
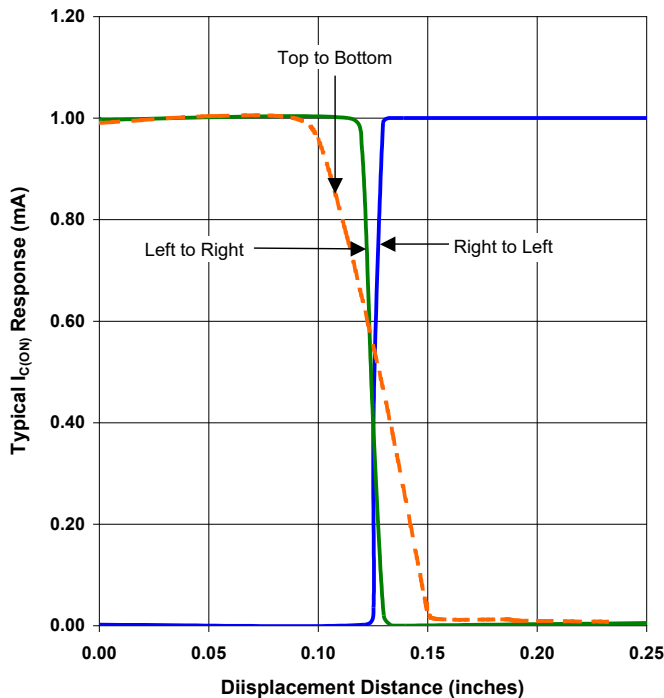

General Note  
 TT Electronics reserves the right to make changes in product specification without notice or liability. All information is subject to TT Electronics' own data and is considered accurate at time of going to print.

TT Electronics | OPTEK Technology  
 2900 E. Plano Pkwy, Plano, TX 75074 | Ph: +1 972 323 2200  
[www.ttelectronics.com](http://www.ttelectronics.com) | [sensors@ttelectronics.com](mailto:sensors@ttelectronics.com)

# Slotted Optical Switch

Series: OPB355T, OPB360, OPB370, OPB380



OPB859, OPB860, OPB870, OPB880, OPB890

Aperture Configuration 51 - Flag Next to Emitter

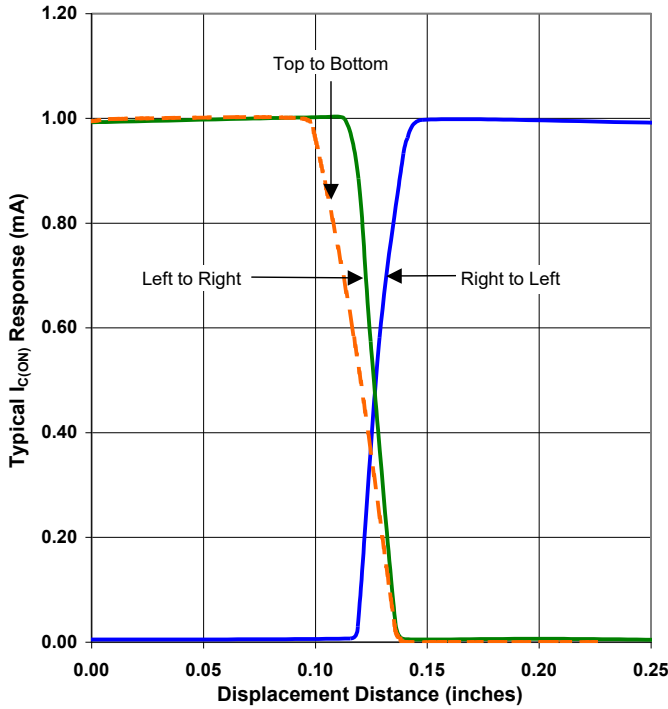

Aperture Configuration 51 - Flag Next to Sensor

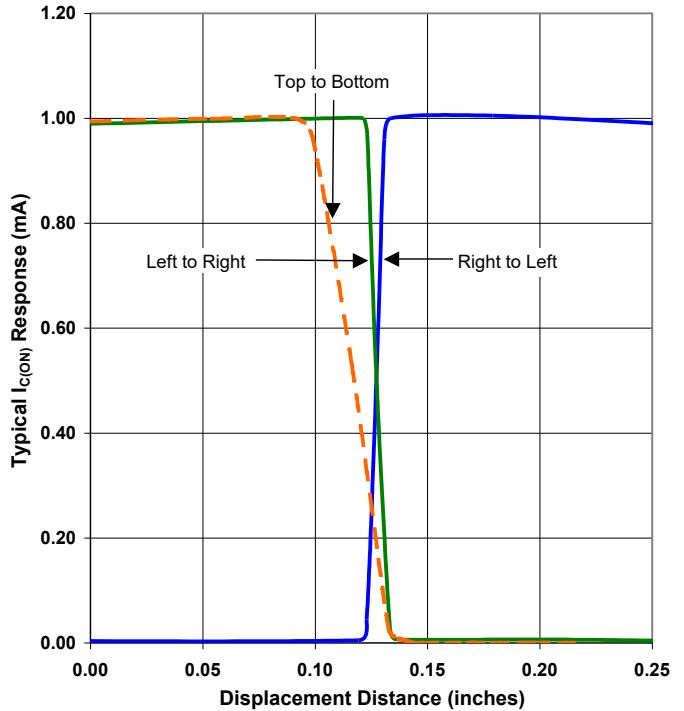

Aperture Configuration 51 - Flag in Middle of Slot

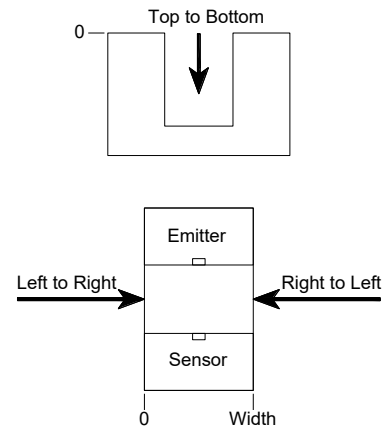
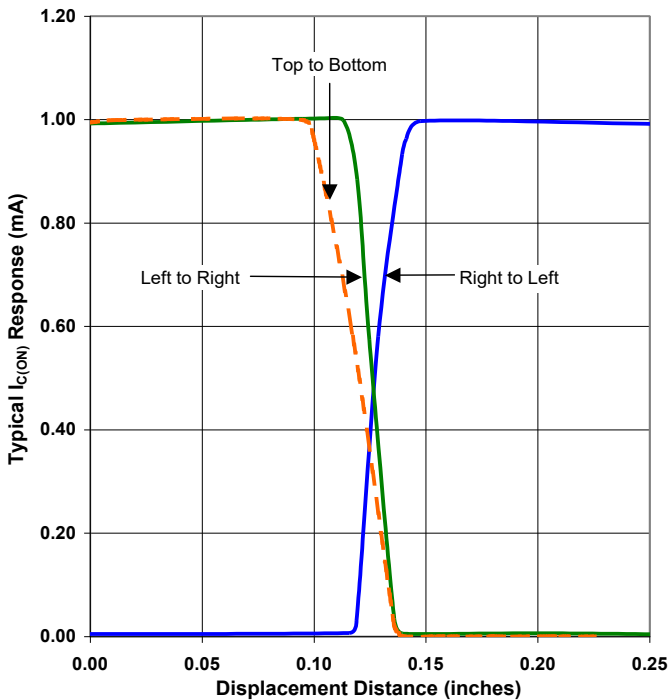

General Note

TT Electronics reserves the right to make changes in product specification without notice or liability. All information is subject to TT Electronics' own data and is considered accurate at time of going to print.

TT Electronics | OPTEK Technology  
2900 E. Plano Pkwy, Plano, TX 75074 | Ph: +1 972 323 2200  
www.ttelectronics.com | sensors@ttelectronics.com