

**ALTERA**  
UNIVERSITY  
PROGRAM

# DEO User Manual

Development and Education Board

*CONTENTS*

<b>Chapter 1 DE0 Package.....</b>	<b>1</b>
1.1 Package Contents .....	1
1.2 The DE0 Board Assembly.....	2
Getting Help.....	2
<b>Chapter 2 Altera DE0 Board.....</b>	<b>4</b>
2.1 Layout and Components .....	4
2.2 Block Diagram of the DE0 Board.....	5
2.3 Power-up the DE0 Board .....	8
<b>Chapter 3 DE0 Control Panel .....</b>	<b>10</b>
3.1 Control Panel Setup .....	10
3.2 Controlling the LEDs and 7-Segment Displays.....	12
3.3 Switches and Buttons .....	14
3.4 SDRAM and Flash Controller and Programmer.....	15
3.5 PS2 Device.....	16
3.6 SD CARD .....	17
3.7 VGA.....	18
<b>Chapter 4 Using the DE0 Board .....</b>	<b>20</b>
4.1 Configuring the Cyclone III FPGA.....	20
4.2 Using the LEDs and Switches.....	23
4.3 Using the 7-segment Displays.....	26
4.4 Clock Circuitry.....	28
4.5 Using the LCD Module.....	29
4.6 Using the Expansion Header.....	31
4.7 Using VGA .....	34
4.8 RS-232 Serial Port .....	37
4.9 PS/2 Serial Port .....	38
4.10 SD Card Socket.....	39
4.11 Using SDRAM and Flash .....	39
<b>Chapter 5 Examples of Advanced Demonstrations .....</b>	<b>44</b>
5.1 DE0 Factory Configuration.....	44
5.2 SD Card.....	45
5.3 VGA Color Pattern Demonstration .....	49
<b>Chapter 6 Appendix.....</b>	<b>53</b>
6.1 Revision History .....	53

6.2 Copyright Statement .....53

# Chapter 1

## DE0 Package

The DE0 package contains all the components needed to use the DE0 board in conjunction with a computer that runs the Microsoft Windows software.

### 1.1 Package Contents

Figure 1-1 shows a photograph of the DE0 package.

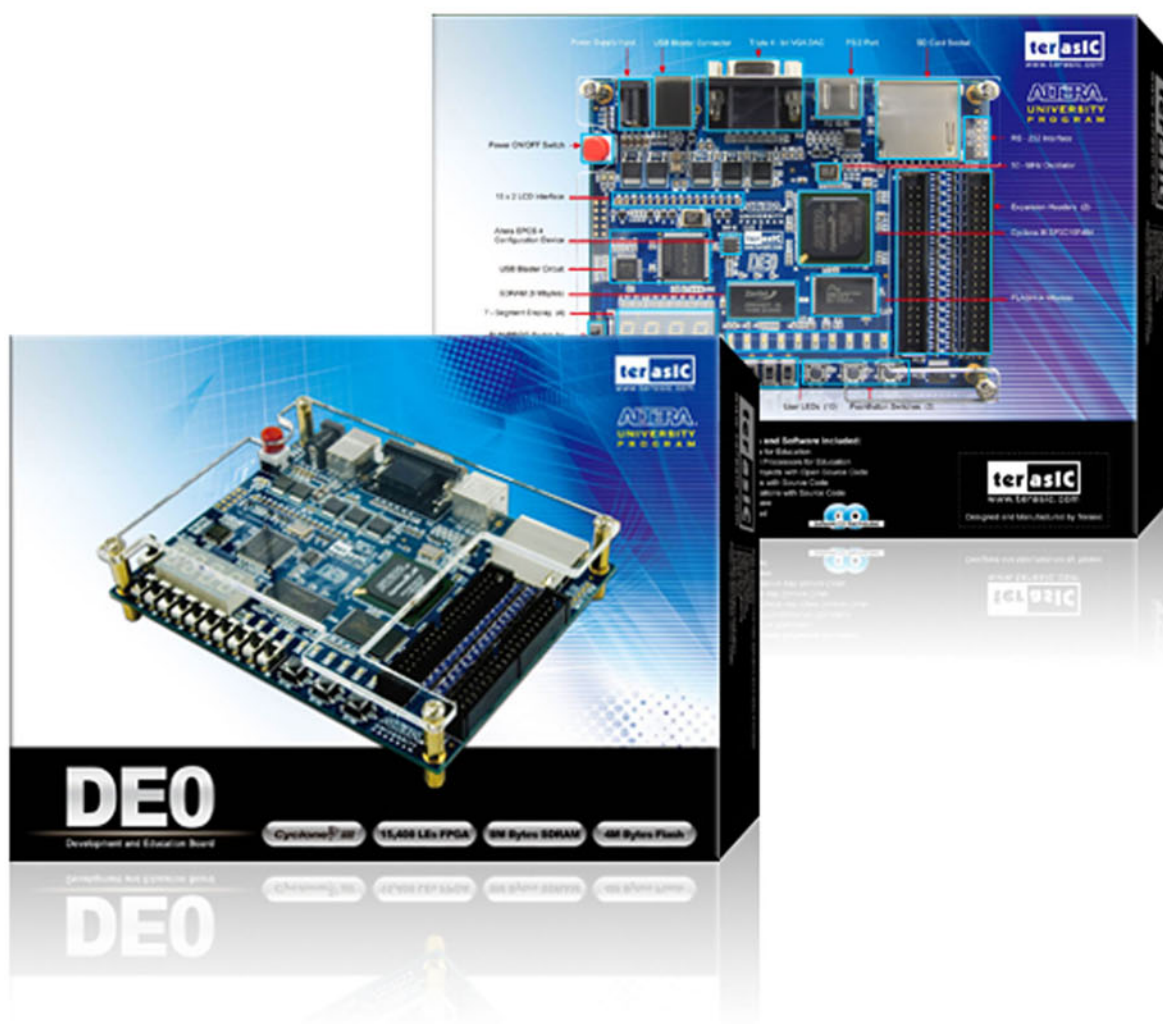

Figure 1-1 The DE0 package contents.

The DE0 package includes:

- The DE0 board
- USB Cable for FPGA programming and control
- DE0 System CD containing :
  - Altera's Quartus<sup>®</sup> II Web Edition and the Nios<sup>®</sup> II Embedded Design Suit Evaluation Edition software
  - the DE0 documentation and supporting materials, including the User Manual, the Control Panel utility, reference designs and demonstrations, device datasheets, tutorials, and a set of laboratory exercises
- Clear plastic cover for the board
- 7.5 DC wall-mount power supply

## 1.2 The DE0 Board Assembly

To assemble the included stands for the DE0 board:

- Assemble a rubber (silicon) cover, as shown in [Figure 1-2](#), for each of the four copper stands on the DE0 board
- The clear plastic cover provides extra protection, and is mounted over the top of the board by using additional stands and screws

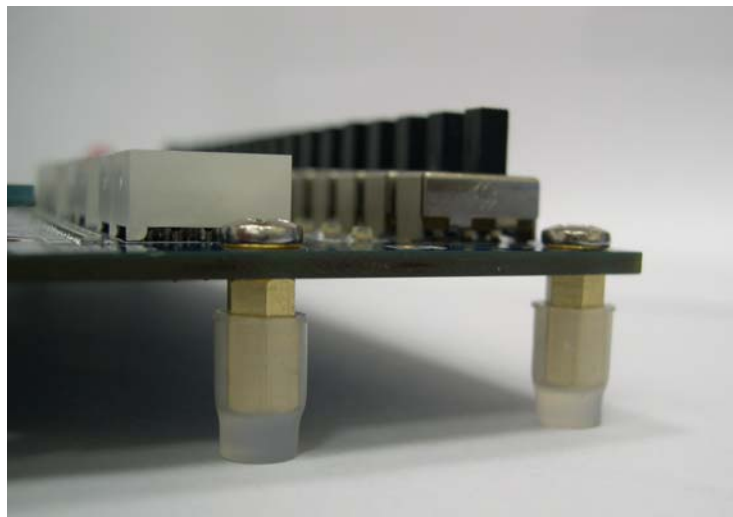

Figure 1-2 The feet for the DE0 board.

### ■ Getting Help

Here are the addresses where you can get help if you encounter problems:

- Altera Corporation  
101 Innovation Drive

San Jose, California, 95134 USA

Email: [university@altera.com](mailto:university@altera.com)

- Terasic Technologies  
No. 356, Sec. 1, Fusing E. Rd.  
Jhubei City, HsinChu County, Taiwan, 302  
Email: [support@terasic.com](mailto:support@terasic.com)  
Web: DE0.terasic.com

# Chapter 2

## Altera DE0 Board

This chapter presents the features and design characteristics of the DE0 board.

### 2.1 Layout and Components

A photograph of the DE0 board is shown in Figure 2-1. It depicts the layout of the board and indicates the location of the connectors and key components.

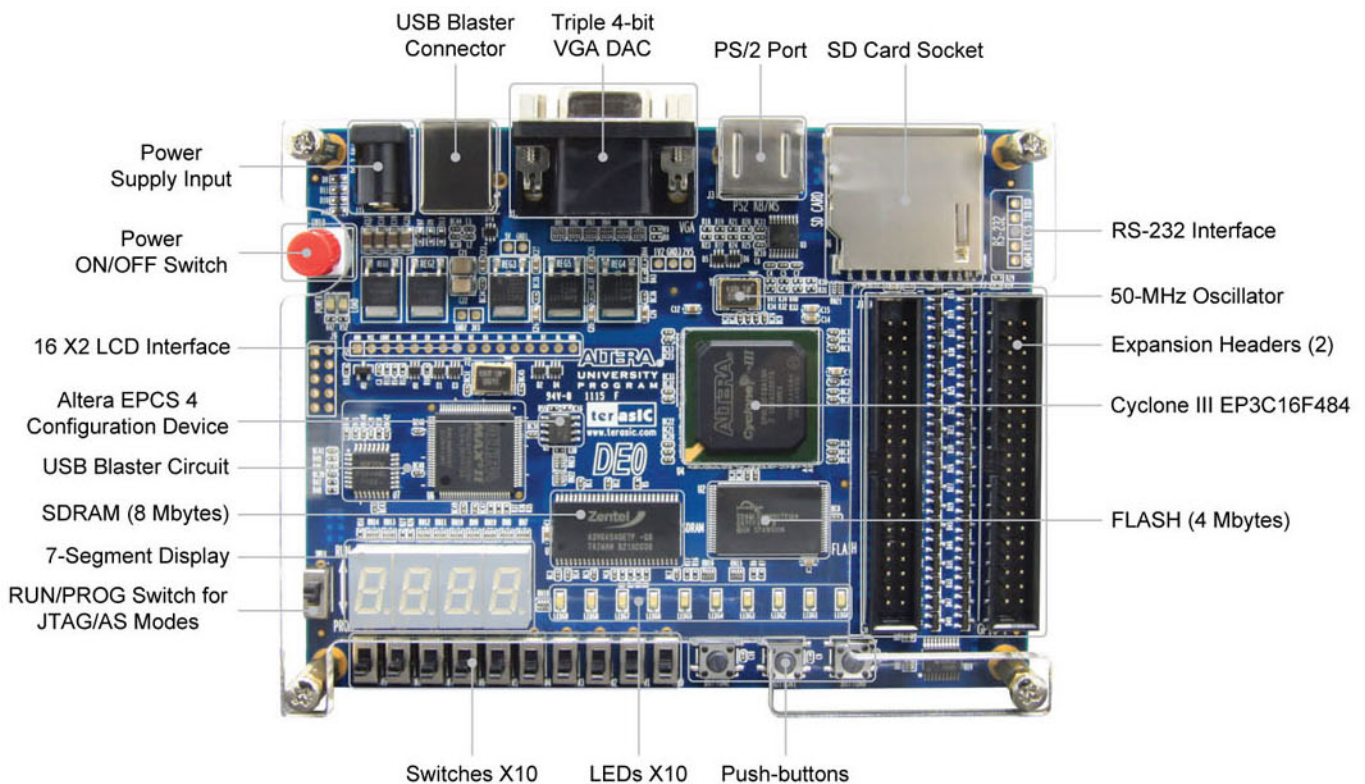

Figure 2-1 The DE0 board.

The DE0 board has many features that allow the user to implement a wide range of designed circuits, from simple circuits to various multimedia projects.

The following hardware is provided on the DE0 board:

- Altera Cyclone® III 3C16 FPGA device
- Altera Serial Configuration device – EPCS4
- USB Blaster (on board) for programming and user API control; both JTAG and Active Serial (AS) programming modes are supported
- 8-Mbyte SDRAM
- 4-Mbyte Flash memory
- SD Card socket
- 3 pushbutton switches
- 10 toggle switches
- 10 green user LEDs
- 50-MHz oscillator for clock sources
- VGA DAC (4-bit resistor network) with VGA-out connector
- RS-232 transceiver
- PS/2 mouse/keyboard connector
- Two 40-pin Expansion Headers

## 2.2 Block Diagram of the DE0 Board

Figure 2-2 gives the block diagram of the DE0 board. To provide maximum flexibility for the user, all connections are made through the Cyclone III FPGA device. Thus, the user can configure the FPGA to implement any system design.



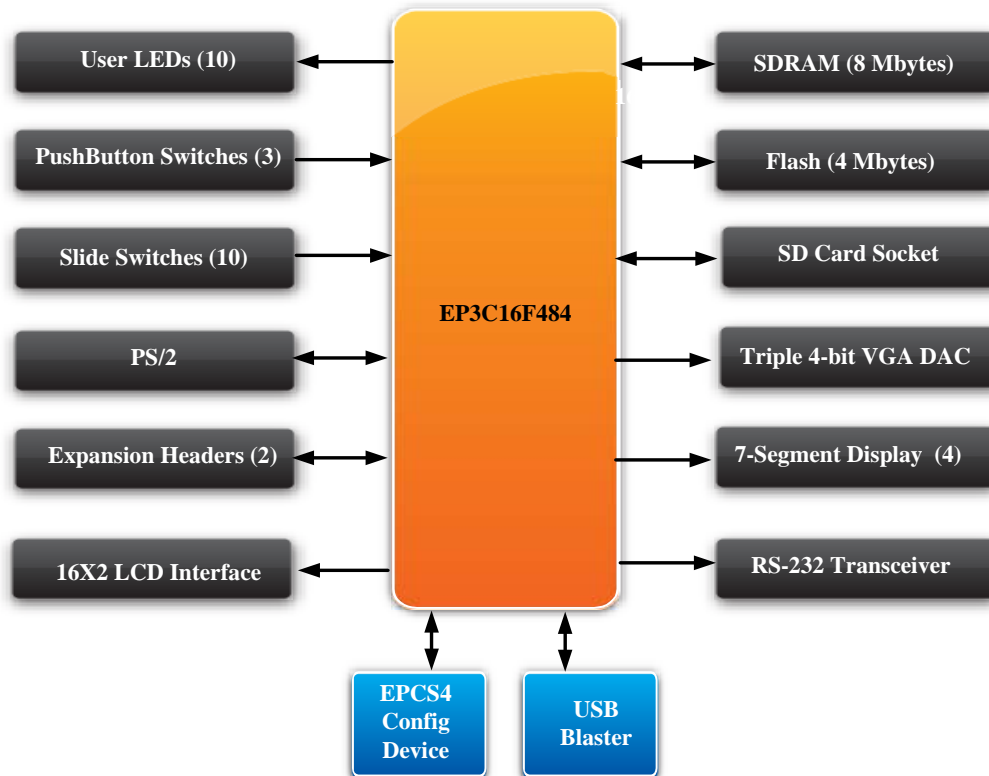

Figure 2-2 Block diagram of the DE0 board.

Following is more detailed information about the blocks in [Figure 2-2](#):

### Cyclone III 3C16 FPGA

- 15,408 LEs
- 56 M9K Embedded Memory Blocks
- 504K total RAM bits
- 56 embedded multipliers
- 4 PLLs
- 346 user I/O pins
- FineLine BGA 484-pin package

### Built-in USB Blaster circuit

- On-board USB Blaster for programming and user API (Application programming interface) control
- Using the Altera EPM240 CPLD

### SDRAM

- One 8-Mbyte Single Data Rate Synchronous Dynamic RAM memory chip
- Supports 16-bits data bus

**Flash memory**

- 4-Mbyte NOR Flash memory
- Support Byte (8-bits)/Word (16-bits) mode

**SD card socket**

- Provides both SPI and SD 1-bit mod SD Card access

**Pushbutton switches**

- 3 pushbutton switches
- Normally high; generates one active-low pulse when the switch is pressed

**Slide switches**

- 10 Slide switches
- A switch causes logic 0 when in the DOWN position and logic 1 when in the UP position

**General User Interfaces**

- 10 Green color LEDs (Active high)
- 4 seven-segment displays (Active low)
- 16x2 LCD Interface (Not include LCD module)

**Clock inputs**

- 50-MHz oscillator

**VGA output**

- Uses a 4-bit resistor-network DAC
- With 15-pin high-density D-sub connector
- Supports up to 1280x1024 at 60-Hz refresh rate

**Serial ports**

- One RS-232 port (Without DB-9 serial connector)
- One PS/2 port (Can be used through a PS/2 Y Cable to allow you to connect a keyboard and mouse to one port)

**Two 40-pin expansion headers**

- 72 Cyclone III I/O pins, as well as 8 power and ground lines, are brought out to two 40-pin expansion connectors
- 40-pin header is designed to accept a standard 40-pin ribbon cable used for IDE hard drives

## 2.3 Power-up the DE0 Board

The DE0 board comes with a preloaded configuration bit stream to demonstrate some features of the board. This bit stream also allows users to see quickly if the board is working properly. To power-up the board perform the following steps:

1. Connect the provided USB cable from the host computer to the USB Blaster connector on the DE0 board. For communication between the host and the DE0 board, it is necessary to install the Altera USB Blaster driver software. If this driver is not already installed on the host computer, it can be installed as explained in the tutorial *Getting Started with Altera's DE0 Board*. This tutorial is available in the directory *DE0\DE0\_user\_manual* on the **DE0 System CD-ROM**.
2. Connect the 7.5V adapter to the DE0 board
3. Connect a VGA monitor to the VGA port on the DE0 board
4. Turn the RUN/PROG switch on the left edge of the DE0 board to RUN position; the PROG position is used only for the AS Mode programming
5. Turn the power on by pressing the ON/OFF switch on the DE0 board

At this point you should observe the following:

- All user LEDs are flashing
- All 7-segment displays are cycling through the numbers 0 to F
- The VGA monitor displays the image shown in [Figure 2-3](#).



Figure 2-3 The default VGA output pattern.

# Chapter 3

## DE0 Control Panel

The DE0 board comes with a Control Panel facility that allows users to access various components on the board from a host computer. The host computer communicates with the board through an USB connection. The facility can be used to verify the functionality of components on the board or be used as a debug tool while developing RTL code.

This chapter first presents some basic functions of the Control Panel, then describes its structure in block diagram form, and finally describes its capabilities.

### 3.1 Control Panel Setup

The Control Panel Software Utility is located in the “DE0\_Control\_panel” folder in the **DE0 System CD-ROM**. To install it, just copy the whole folder to your host computer.

To activate the Control Panel, perform the following steps:

1. Make sure Quartus II and USB-Blaster Driver are installed successfully on your PC.
2. Connect the supplied USB cable to the USB Blaster port, connect the 7.5V power supply, and turn the power switch ON
3. Set the RUN/PROG switch to the RUN position
4. Start the executable *DE0\_ControlPanel.exe* on the host computer. The Control Panel user interface shown in [Figure 3-1](#) will appear.

**When the control panel window appears, it will automatically download the bit stream file .sof into the FPGA. If any error message shows up as shown in [Figure 3-2](#), please check steps 1 to 3 has been performed. Then, click *Download Code* button to program FPGA again. Note, the Control Panel will occupy the USB port until you close that port; you cannot use Quartus II to download a configuration file into the FPGA until you close the USB port.**

5. The Control Panel is now ready to be use; experiment by setting the value of the LEDs display and observe the result on the DE0 board.

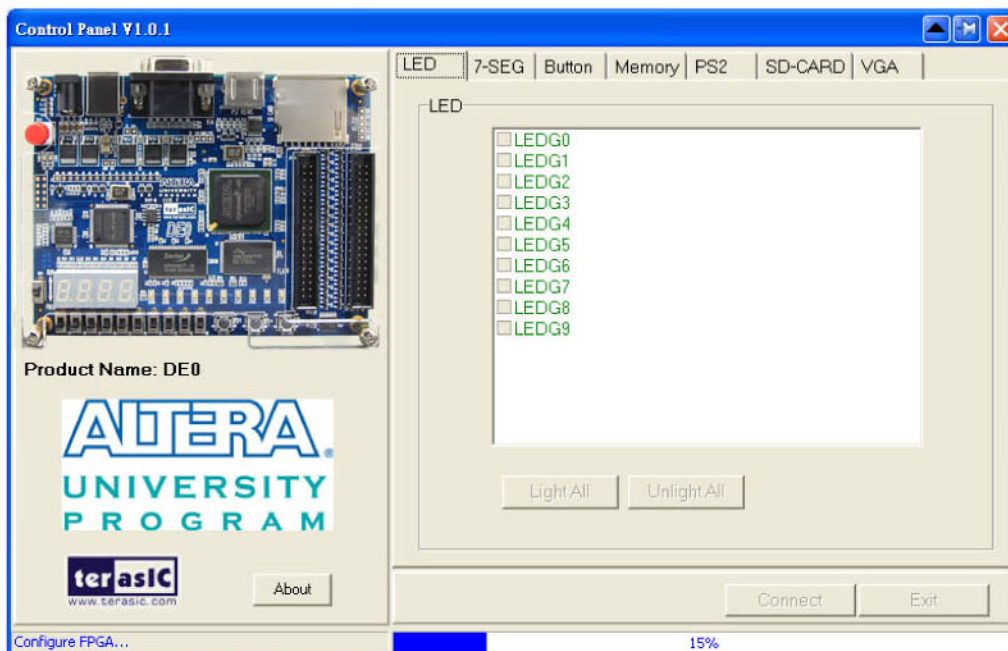

Figure 3-1. The DE0 Control Panel.

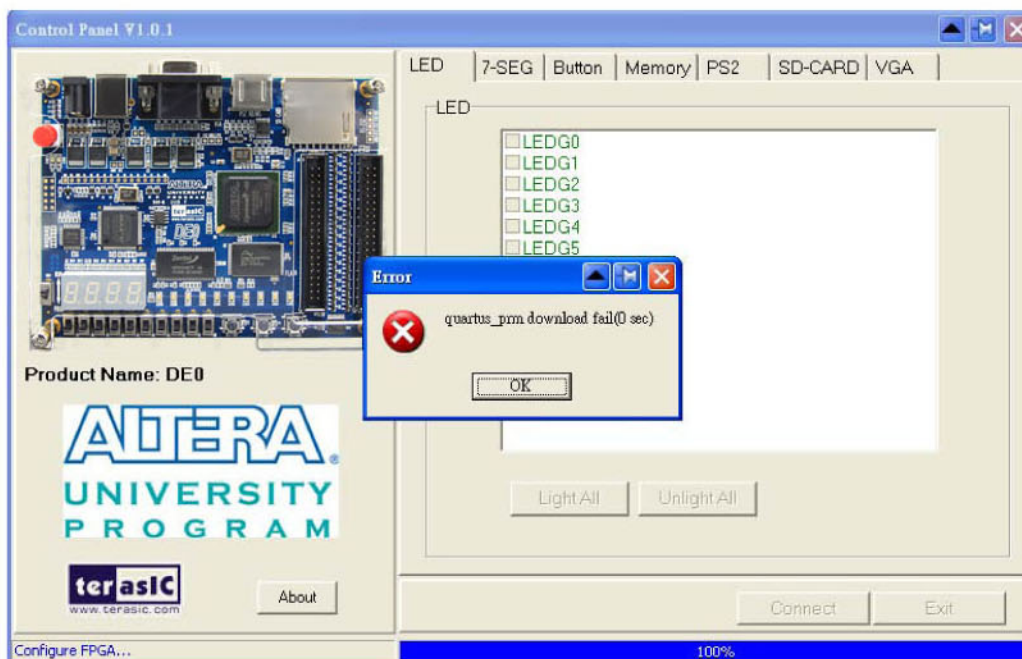

Figure 3-2. The error message of the DE0 Control Panel.

The concept of the DE0 Control Panel is illustrated in Figure 3-3. The “Control Codes” that perform the control functions is implemented in the FPGA board. It communicates with the Control Panel window, which is active on the host computer, via the USB Blaster link. The graphical interface is used to issue commands to the control codes. It handles all requests and performs data transfers between the computer and the DE0 board.

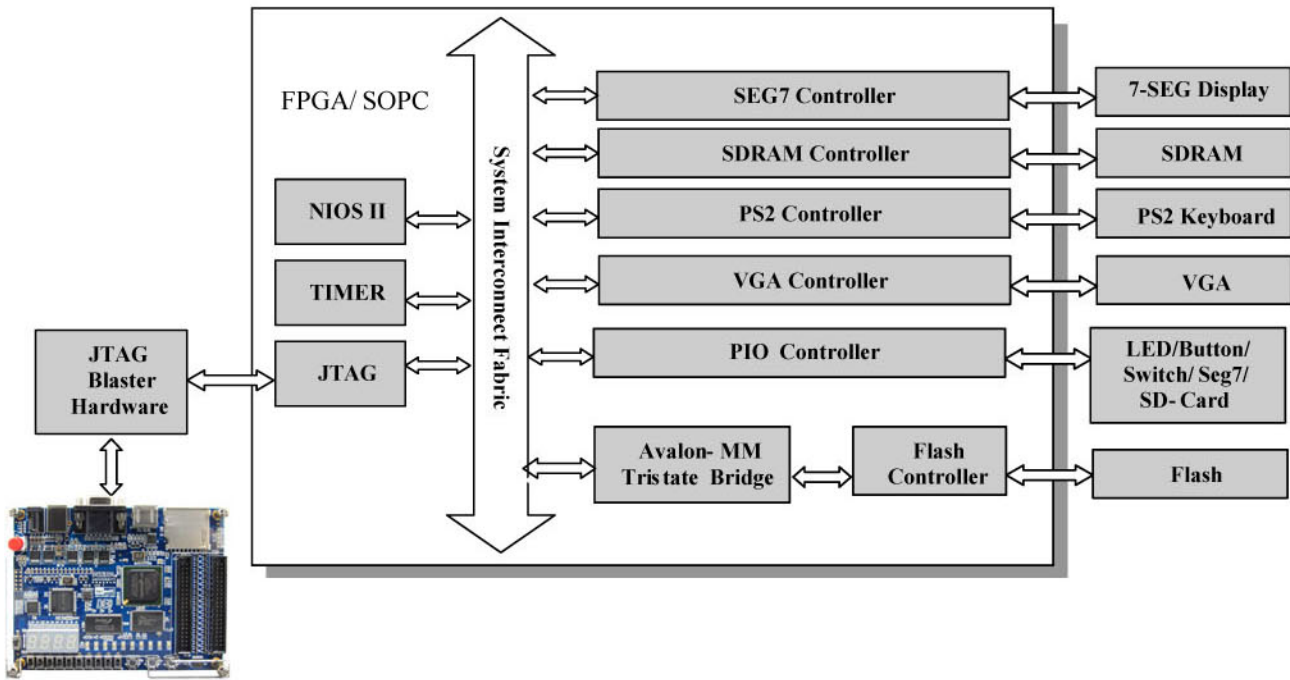

Figure 3-3. The DE0 Control Panel concept.

The DE0 Control Panel can be used to light up the LEDs, change the values displayed on 7-segment, monitor buttons/switches status, read/write the SDRAM and Flash Memory, read data from a PS/2 keyboard, output color pattern to LCD monitor via VGA connector, and read SD-CARD specification information. The feature of reading/writing a word or an entire file from/to the Flash Memory allows the user to develop multimedia application (Flash Picture Viewer) without worrying about how to build a Memory Programmer.

## 3.2 Controlling the LEDs and 7-Segment Displays

A simple function of the Control Panel is to allow setting the values displayed on LEDs and the 7-segment displays.

Choosing the **LED** tab leads to the window in [Figure 3-4](#). Here, you can directly turn the individual LEDs on or off by selecting them individually or by clicking “Light All” or “Unlight All”.

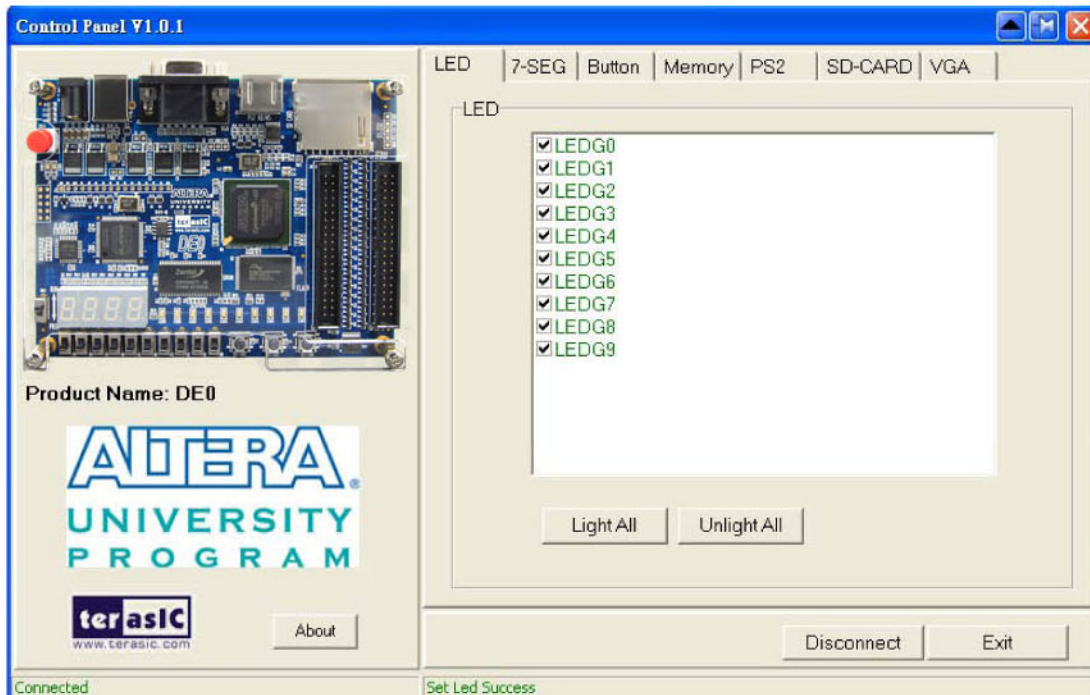

Figure 3-4. Controlling LEDs

Choosing the **7-SEG** tab leads to the window in [Figure 3-5](#). In the tab sheet, directly use the **Up-Down** control and **Dot** Check box to specified desired patterns, the 7-SEG patterns on the board will be updated immediately.

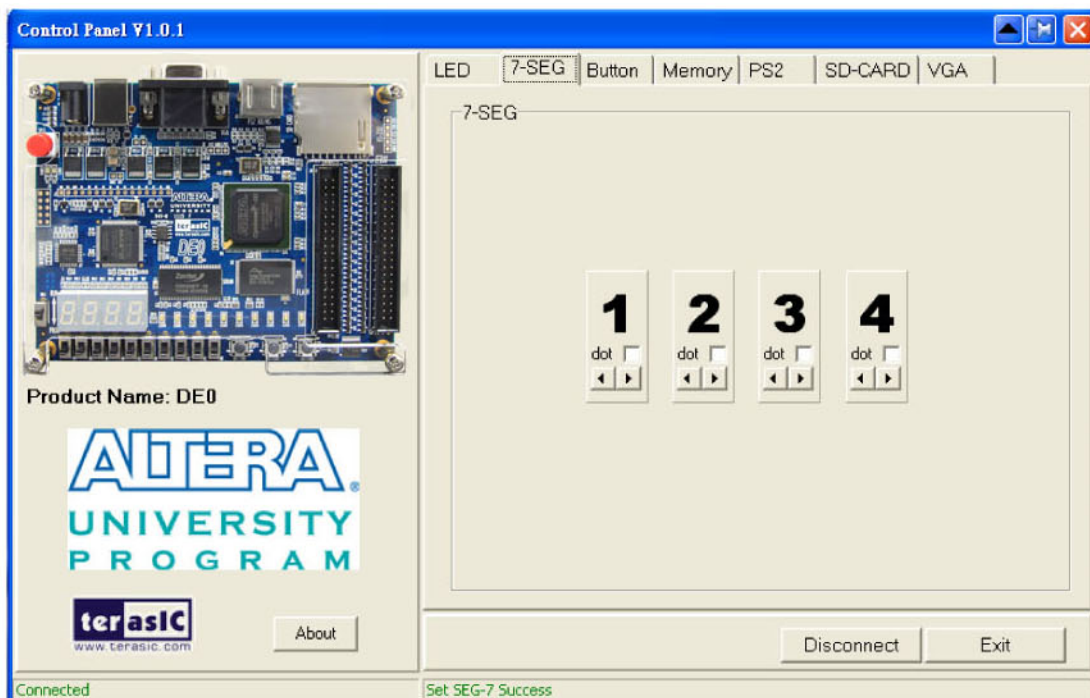

Figure 3-5. Controlling 7-SEG display.



The ability to set arbitrary values into simple display devices is not needed in typical design activities. However, it gives the user a simple mechanism for verifying that these devices are functioning correctly in case a malfunction is suspected. Thus, it can be used for troubleshooting purposes.

### 3.3 Switches and Buttons

Choosing the **Button** tab leads to the window in Figure 3-6. The function is designed to monitor the status of switches and buttons in real time and show the status in a graphical user interface. It can be used to verify the functionality of the switches and buttons.

Press the **Start** button to start button/switch status monitoring process, and button caption is changed from **Start** to **Stop**. In the monitoring process, the status of buttons and switches on the board is shown in the GUI window and updated in real time. Press **Stop** to end the monitoring process.

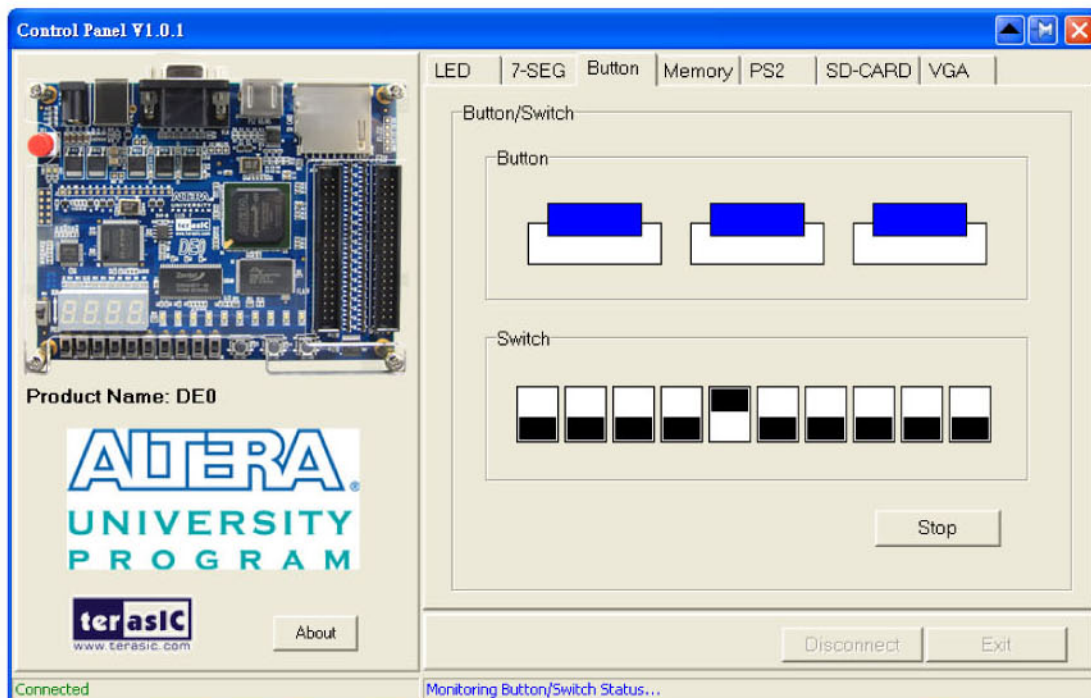

Figure 3-6. Monitoring switches and buttons.

The ability to check the status of button and switch is not needed in typical design activities. However, it provides users a simple mechanism for verifying if the buttons and switches are functioning correctly. Thus, it can be used for troubleshooting purposes.

### 3.4 SDRAM and Flash Controller and Programmer

The Control Panel can be used to write/read data to/from the SDRAM and FLASH chips on the DE0 board. Click on the **Memory** tab and select “SDRAM” to reach the window in Figure 3-7. Please note to erase the flash memory before writing data to it.

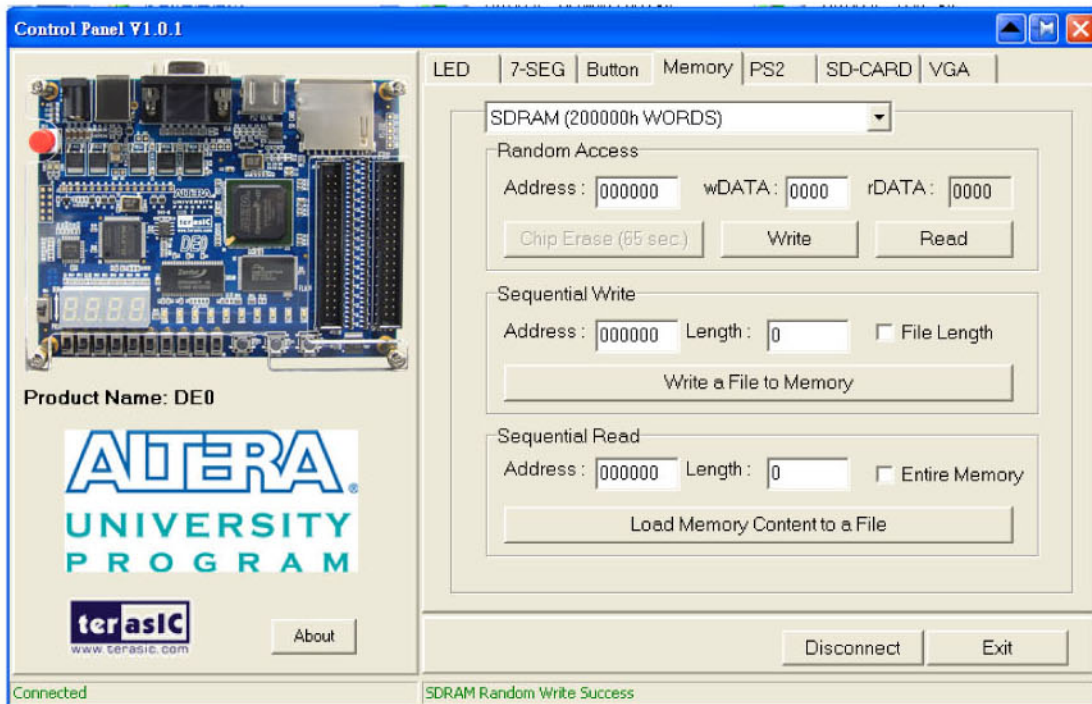

Figure 3-7. Accessing the SDRAM

A 16-bit word can be written into the SDRAM by entering the address of the desired location, specifying the data to be written, and pressing the **Write** button. Contents of the location can be read by pressing the **Read** button. Figure 3-7 depicts the result of writing the hexadecimal value 7eff into location 000000, followed by reading the same location.

The Sequential Write function of the Control Panel is used to write the contents of a file into the SDRAM as follows:

1. Specify the starting address in the **Address** box.
2. Specify the number of bytes to be written in the **Length** box. If the entire file is to be loaded, then a checkmark may be placed in the **File Length** box instead of giving the number of bytes.
3. To initiate the writing of data, click on the **Write a File to Memory** button.
4. When the Control Panel responds with the standard Windows dialog box asking for the source file, specify the desired file in the usual manner.

The Control Panel also supports loading files with a *.hex* extension. Files with a *.hex* extension are ASCII text files that specify memory values using ASCII characters to represent hexadecimal values. For example, a file containing the line

0123456789ABCDEF

defines four 8-bit values: 01, 23, 45, 67, 89, AB, CD, EF. These values will be loaded consecutively into the memory.

The Sequential Read function is used to read the contents of the SDRAM and place them into a file as follows:

1. Specify the starting address in the **Address** box.
2. Specify the number of bytes to be copied into the file in the **Length** box. If the entire contents of the SDRAM are to be copied (which involves all 8 Mbytes), then place a checkmark in the **Entire Memory** box.
3. Press **Load Memory Content to a File** button.
4. When the Control Panel responds with the standard Windows dialog box asking for the destination file, specify the desired file in the usual manner.

Users can use the similar way to access the Flash. Please note that users need to erase the flash before writing data to it.

### 3.5 PS2 Device

The Control Panel provides users a tool to receive the inputs from a PS2 keyboard in real time. The received scan-codes are translated to ASCII code and displayed in the control window. Only visible ASCII codes are displayed. For control key, only “Carriage Return/ENTER” key is implemented. This function can be used to verify the functionality of the PS2 Interface. Please follow the steps below to exercise the PS2 device:

1. Choosing the **PS2** tab leads to the window in [Figure 3-8](#).
2. Plug a PS2 Keyboard to the FPGA board. Then,
3. Press the **Start** button to start PS2Keyboard input receiving process; Button caption is changed from **Start** to **Stop**.
4. In the receiving process, users can start to press the attached keyboard. The input data will be displayed in the control window in real time. Press **Stop** to terminate the monitoring process.

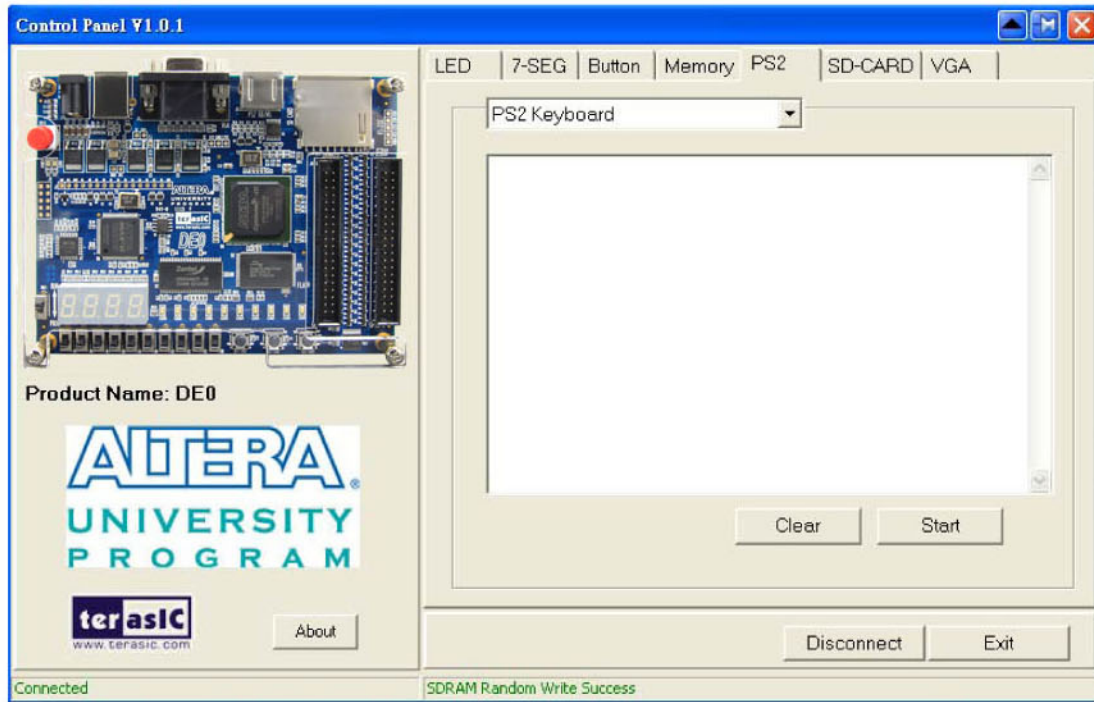

Figure 3-8. Reading the PS2 Keyboards

### 3.6 SD CARD

The function is designed to read the identification and specification of the SD card. The 1-bit SD MODE is used to access the SD card. This function can be used to verify the functionality of SD-CARD Interface. Follow the steps below to exercise the SD card:

1. Choosing the **SD-CARD** tab leads to the window in [Figure 3-9](#).
2. Insert a SD card to the DE0 board, then press the **Read** button to read the SD card. The SD card's identification and specification will be displayed in the control window.

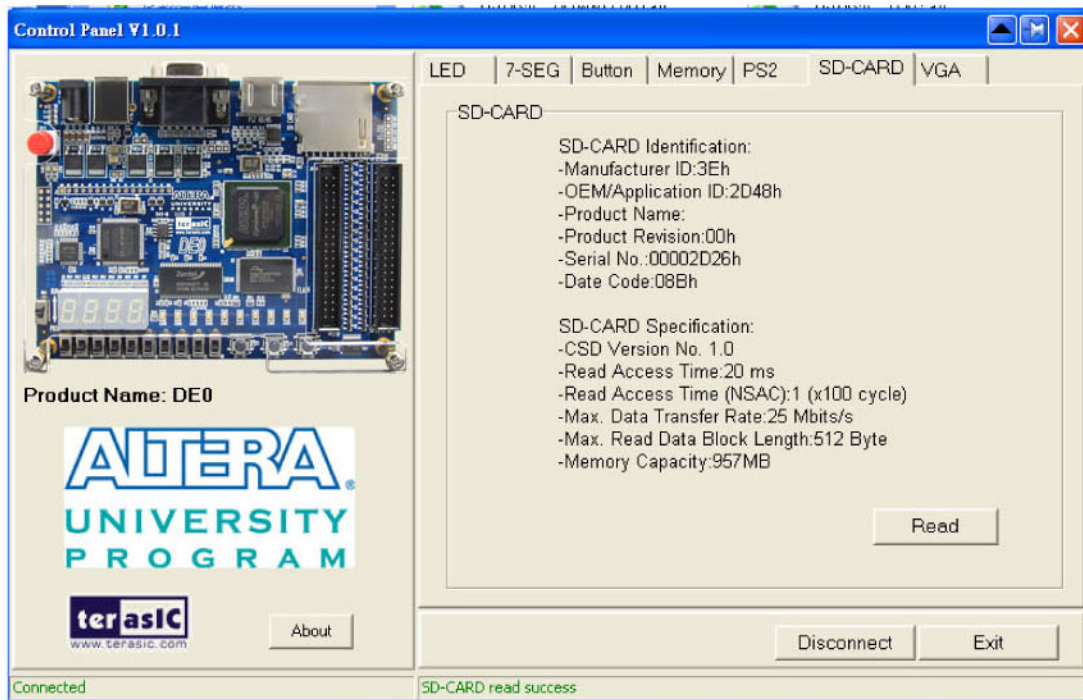

Figure 3-9. Reading the SD card Identification and Specification

### 3.7 VGA

DE0 control panel provides VGA pattern function that allows users to output color pattern to LCD/CRT monitor using the DE0 FPGA board. Please follow the steps below to generate the VGA pattern function:

1. Choosing the VGA tab leads to the window in [Figure 3-10](#).
2. Plug a D-sub cable to the VGA connector of the DE0 board and LCD/CRT monitor.
3. The LCD/CRT monitor will display the same color pattern on the control panel window.
4. Click the drop down menu shown in [Figure 3-10](#) where you can output the selected color individually.

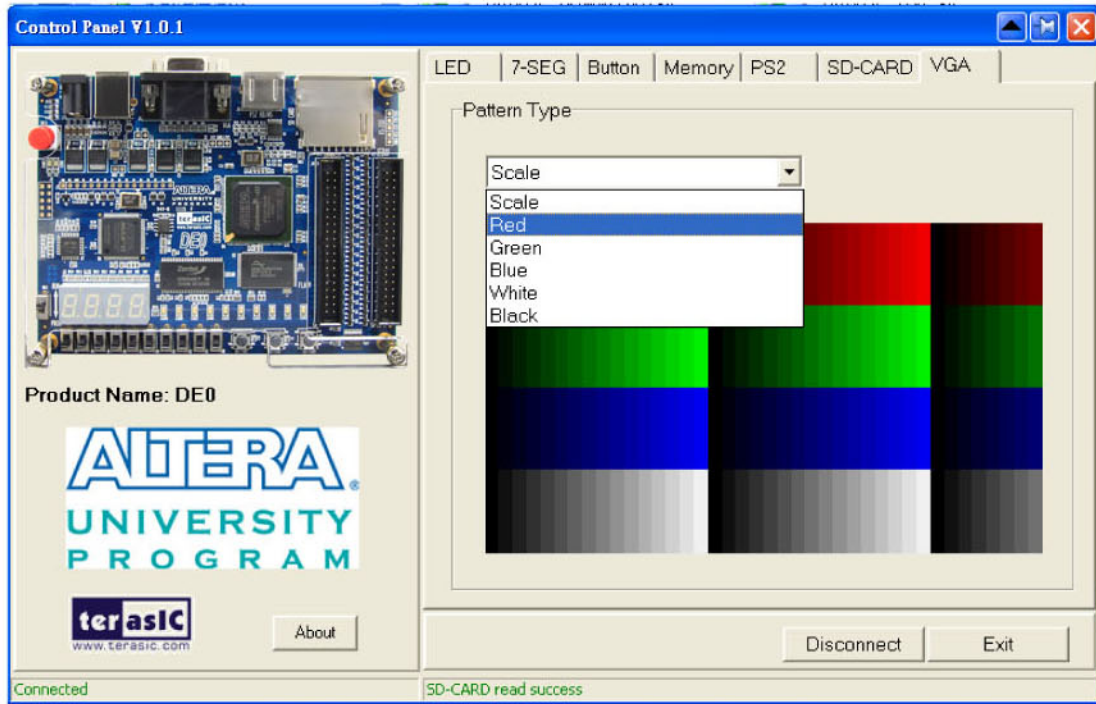

Figure 3-10. Controlling VGA display

# Chapter 4

## Using the DE0 Board

This chapter gives instructions for using the DE0 board and describes each of its I/O devices.

### 4.1 Configuring the Cyclone III FPGA

The procedure for downloading a circuit from a host computer to the DE0 board is described in the tutorial *Getting Started with Altera's DE0 Board*. This tutorial is found in the *user\_manual* folder on the **DE0 System CD-ROM**. The user is encouraged to read the tutorial first, and to treat the information below as a short reference.

The DE0 board contains a serial EEPROM chip that stores configuration data for the Cyclone III FPGA. This configuration data is automatically loaded from the EEPROM chip into the FPGA each time power is applied to the board. Using the Quartus II software, it is possible to reprogram the FPGA at any time, and it is also possible to change the non-volatile data that is stored in the serial EEPROM chip. Both types of programming methods are described below.

1. *JTAG* programming: In this method of programming, named after the IEEE standards *Joint Test Action Group*, the configuration bit stream is downloaded directly into the Cyclone III FPGA. The FPGA will retain this configuration as long as power is applied to the board; the configuration is lost when the power is turned off.
2. *AS* programming: In this method, called *Active Serial* programming, the configuration bit stream is downloaded into the Altera EPCS4 serial EEPROM chip. It provides non-volatile storage of the bit stream, so that the information is retained even when the power supply to the DE0 board is turned off. When the board's power is turned on, the configuration data in the EPCS4 device is automatically loaded into the Cyclone III FPGA.

The sections below describe the steps used to perform both JTAG and AS programming. For both methods the DE0 board is connected to a host computer via a USB cable. Using this connection, the board will be identified by the host computer as an Altera *USB Blaster* device. The process for installing on the host computer the necessary software device driver that communicates with the USB Blaster is described in the tutorial *Getting Started with Altera's DE0 Board*. This tutorial is available on the **DE0 System CD-ROM**.

### Configuring the FPGA in JTAG Mode

Figure 4-1 illustrates the JTAG configuration setup. To download a configuration bit stream into the Cyclone III FPGA, perform the following steps:

- Ensure that power is applied to the DE0 board
- Connect the supplied USB cable to the USB Blaster port on the DE0 board (see Figure 2-1)
- Configure the JTAG programming circuit by setting the RUN/PROG switch (see Figure 4-2) to the RUN position.
- The FPGA can now be programmed by using the Quartus II Programmer module to select a configuration bit stream file with the *.sof* filename extension

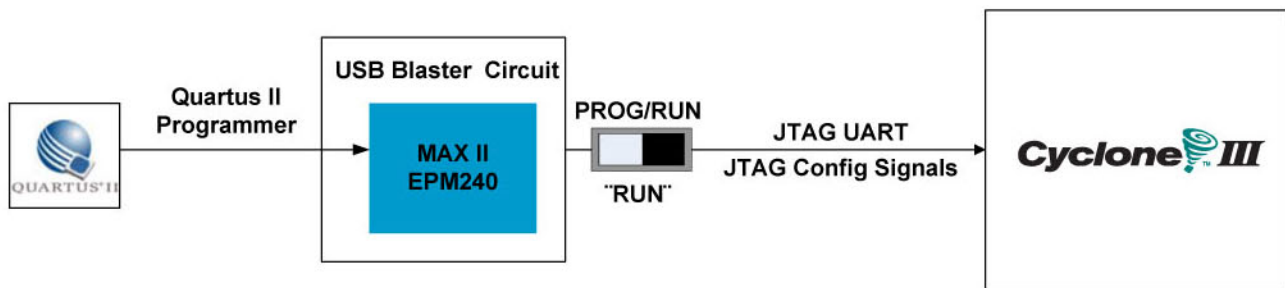

Figure 4-1. The JTAG configuration scheme

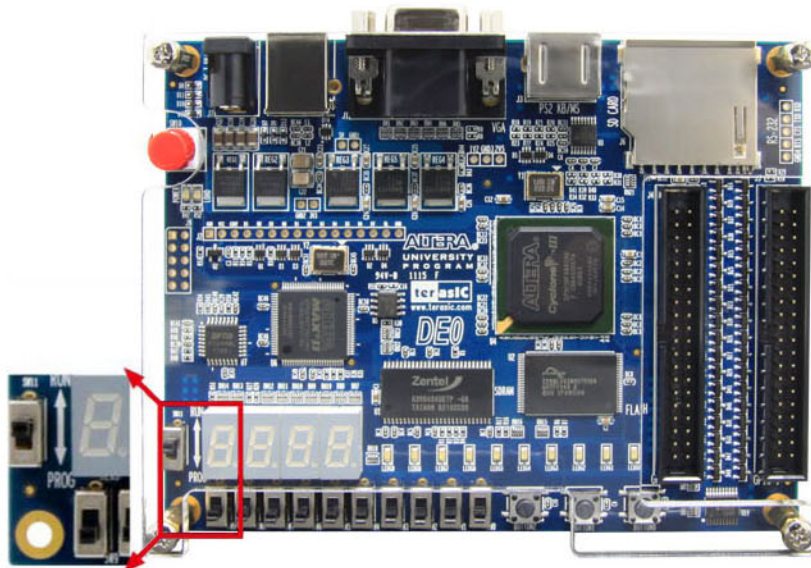

Figure 4-2. The RUN/PROG switch (SW11) is set in JTAG mode

### Configuring the EPCS4 in AS Mode

Figure 4-3 illustrates the AS configuration set up. To download a configuration bit stream into the EPCS4 serial EEPROM device, perform the following steps:

- Ensure that power is applied to the DE0 board



- Connect the supplied USB cable to the USB Blaster port on the DE0 board (see [Figure 2-1](#))
- Configure the JTAG programming circuit by setting the RUN/PROG switch (see [Figure 4-4](#)) to the PROG position.
- The EPCS4 chip can now be programmed by using the Quartus II Programmer module to select a configuration bit stream file with the *.pof* filename extension
- Once the programming operation is finished, set the RUN/PROG switch back to the RUN position and then reset the board by turning the power switch off and back on; this action causes the new configuration data in the EPCS4 device to be loaded into the FPGA chip.

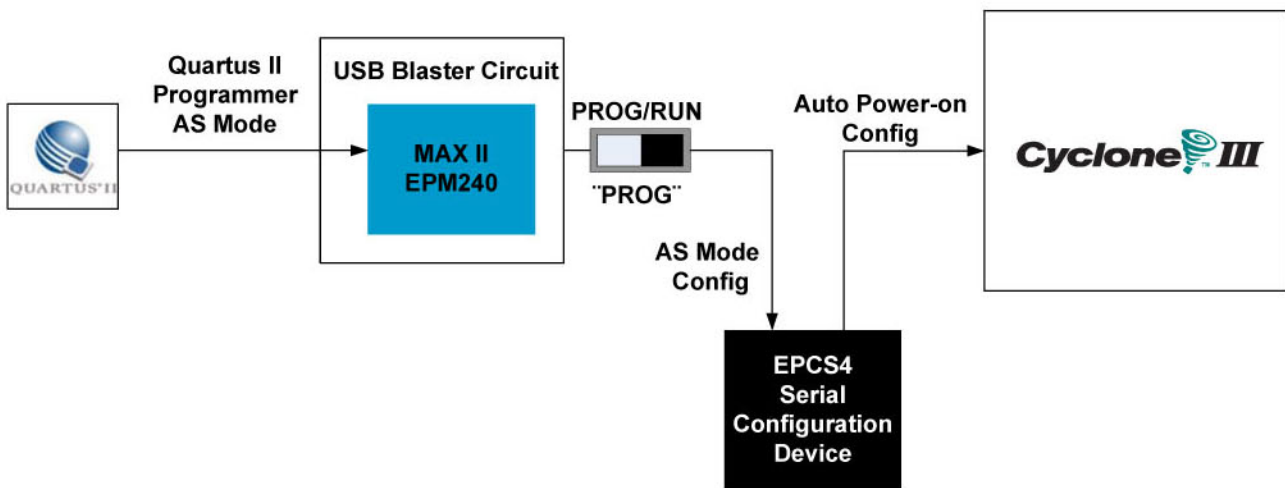

Figure 4-3. The AS configuration scheme

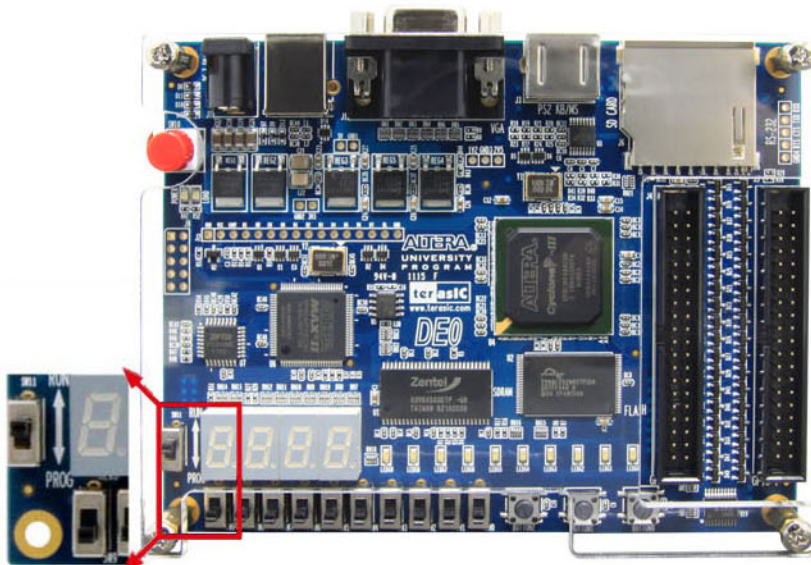

Figure 4-4. The RUN/PROG switch (SW11) is set in AS mode

In addition to its use for JTAG and AS programming, the USB Blaster port on the DE0 board can also be used to control some of the board's features remotely from a host computer. Details that describe this method of using the USB Blaster port are given in Chapter 3.

## 4.2 Using the LEDs and Switches

The DE0 board provides three pushbutton switches. The three outputs called *BUTTON0*, *BUTTON 1*, and *BUTTON2* are connected directly to the Cyclone III FPGA. Each switch provides a high logic level (3.3 volts) when it is not pressed, and provides a low logic level (0 volts) when depressed.

There are also 10 slide switches (sliders) on the DE0 board. These switches are not debounced, and are intended for use as level-sensitive data inputs to a circuit. Each switch is connected directly to a pin on the Cyclone III FPGA. When a switch is in the DOWN position (closest to the edge of the board) it provides a low logic level (0 volts) to the FPGA, and when the switch is in the UP position it provides a high logic level (3.3 volts).

There are 10 user-controllable LEDs on the DE0 board. Each LED is driven directly by a pin on the Cyclone III FPGA; driving its associated pin to a high logic level turns the LED on, and driving the pin low turns it off. [Figure 4-5](#) and [Figure 4-7](#) show the connections between the push buttons, slide switches, and Cyclone III FPGA

As indicated in [Figure 4-6](#), each of these switches is debounced using a Schmitt Trigger circuit. The three outputs called *BUTTON0*, *BUTTON1*, and *BUTTON2* of the Schmitt Trigger devices are connected directly to the Cyclone III FPGA (only PCB 10-0100730-A0 version contains the debounced circuit).

A list of the pin names on the Cyclone III FPGA that are connected to the toggle switches is given in [Table 4.1](#). Similarly, the pins used to connect to the pushbutton switches and LEDs are displayed in [Table 4.2](#) and [Table 4.3](#), respectively.

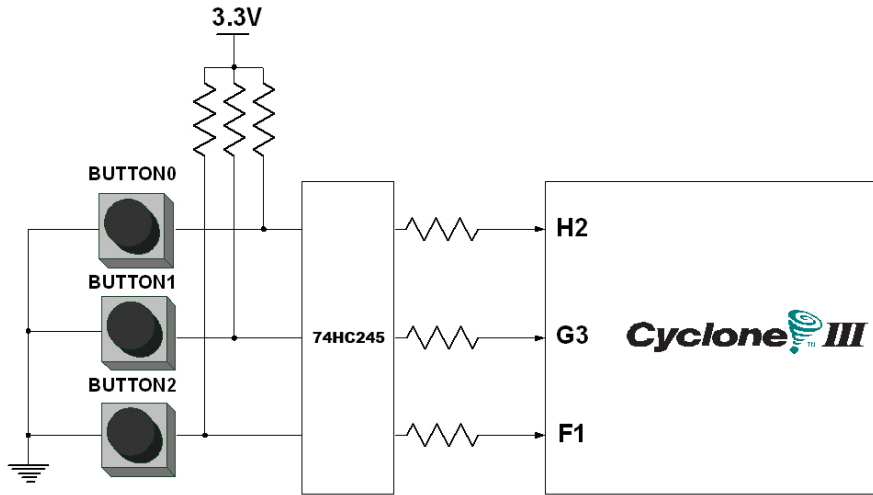

Figure 4-5. Connections between the pushbutton and Cyclone III FPGA

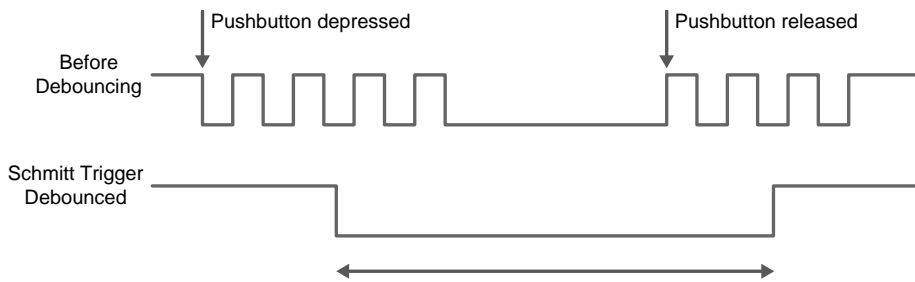

Figure 4-6 Switch debouncing

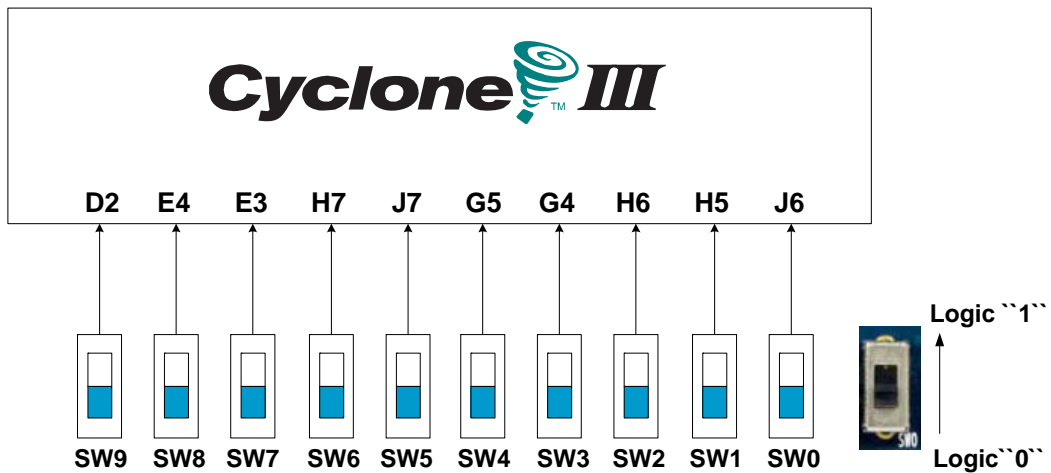

Figure 4-7 Connections between the toggle switches and Cyclone III FPGA

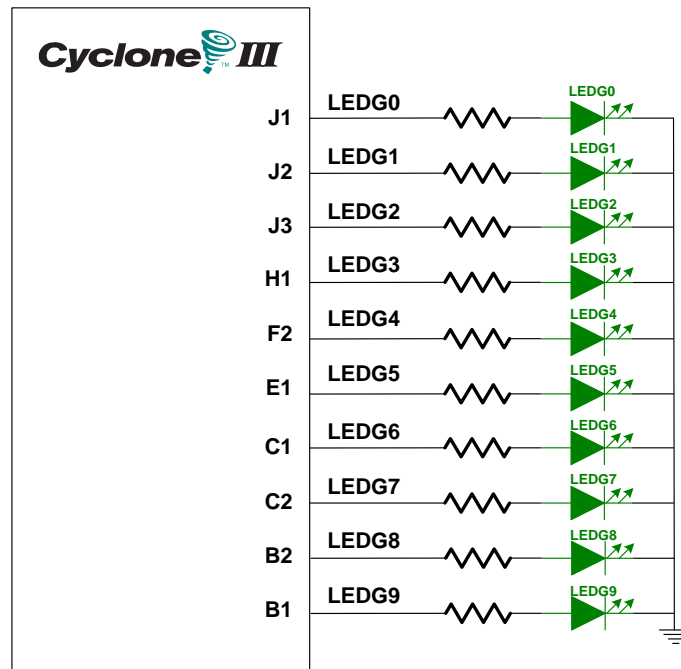

Figure 4-8 Connections between the LEDs and Cyclone III FPGA

Table 4.1. Pin assignments for the slide switches

Signal Name	FPGA Pin No.	Description
SW[0]	PIN_J6	Slide Switch[0]
SW[1]	PIN_H5	Slide Switch[1]
SW[2]	PIN_H6	Slide Switch[2]
SW[3]	PIN_G4	Slide Switch[3]
SW[4]	PIN_G5	Slide Switch[4]
SW[5]	PIN_J7	Slide Switch[5]
SW[6]	PIN_H7	Slide Switch[6]
SW[7]	PIN_E3	Slide Switch[7]
SW[8]	PIN_E4	Slide Switch[8]
SW[9]	PIN_D2	Slide Switch[9]

Table 4.2. Pin assignments for the pushbutton switches

Signal Name	FPGA Pin No.	Description
BUTTON [0]	PIN_H2	Pushbutton[0]
BUTTON [1]	PIN_G3	Pushbutton[1]
BUTTON [2]	PIN_F1	Pushbutton[2]

Table 4.3. Pin assignments for the LEDs

Signal Name	FPGA Pin No.	Description
LEDG[0]	PIN_J1	LED Green[0]
LEDG[1]	PIN_J2	LED Green[1]
LEDG[2]	PIN_J3	LED Green[2]
LEDG[3]	PIN_H1	LED Green[3]
LEDG[4]	PIN_F2	LED Green[4]
LEDG[5]	PIN_E1	LED Green[5]
LEDG[6]	PIN_C1	LED Green[6]
LEDG[7]	PIN_C2	LED Green[7]
LEDG[8]	PIN_B2	LED Green[8]
LEDG[9]	PIN_B1	LED Green[9]

### 4.3 Using the 7-segment Displays

The DE0 board has four 7-segment displays. These displays are arranged into two pairs and a group of four, with the intent of displaying numbers of various sizes. As indicated in Figure 4-9, the seven segments are connected to pins on the Cyclone III FPGA. Applying a low logic level to a segment causes it to light up, and applying a high logic level turns it off.

Each segment in a display is identified by an index from 0 to 6, with the positions given in Figure 4-10. In addition, the decimal point is identified as DP. Table 4.4 shows the connections between the FPGA pins to the 7-segment displays.

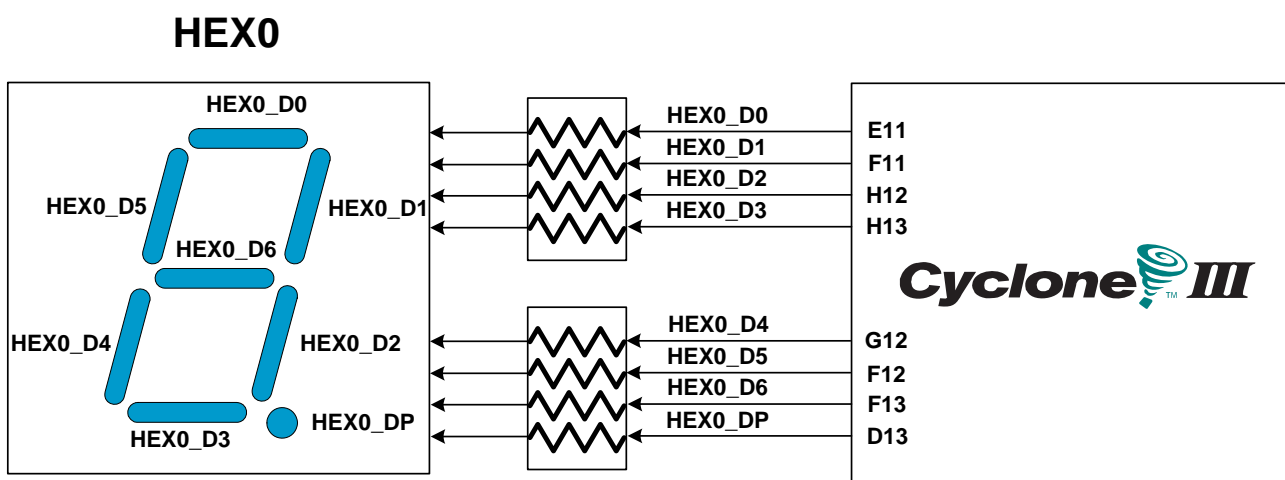

Figure 4-9 Connections between the 7-segment displays and Cyclone III FPGA

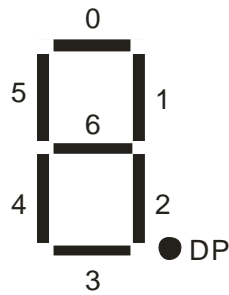

Figure 4-10 Position and index of each segment in a 7-segment display

Table 4.4. Pin assignments for the 7-segment displays.

Signal Name	FPGA Pin No.	Description
HEX0_D[0]	PIN_E11	Seven Segment Digit 0[0]
HEX0_D[1]	PIN_F11	Seven Segment Digit 0[1]
HEX0_D[2]	PIN_H12	Seven Segment Digit 0[2]
HEX0_D[3]	PIN_H13	Seven Segment Digit 0[3]
HEX0_D[4]	PIN_G12	Seven Segment Digit 0[4]
HEX0_D[5]	PIN_F12	Seven Segment Digit 0[5]
HEX0_D[6]	PIN_F13	Seven Segment Digit 0[6]
HEX0_DP	PIN_D13	Seven Segment Decimal Point 0
HEX1_D[0]	PIN_A13	Seven Segment Digit 1[0]
HEX1_D[1]	PIN_B13	Seven Segment Digit 1[1]
HEX1_D[2]	PIN_C13	Seven Segment Digit 1[2]
HEX1_D[3]	PIN_A14	Seven Segment Digit 1[3]
HEX1_D[4]	PIN_B14	Seven Segment Digit 1[4]
HEX1_D[5]	PIN_E14	Seven Segment Digit 1[5]
HEX1_D[6]	PIN_A15	Seven Segment Digit 1[6]
HEX1_DP	PIN_B15	Seven Segment Decimal Point 1
HEX2_D[0]	PIN_D15	Seven Segment Digit 2[0]
HEX2_D[1]	PIN_A16	Seven Segment Digit 2[1]
HEX2_D[2]	PIN_B16	Seven Segment Digit 2[2]
HEX2_D[3]	PIN_E15	Seven Segment Digit 2[3]
HEX2_D[4]	PIN_A17	Seven Segment Digit 2[4]
HEX2_D[5]	PIN_B17	Seven Segment Digit 2[5]
HEX2_D[6]	PIN_F14	Seven Segment Digit 2[6]
HEX2_DP	PIN_A18	Seven Segment Decimal Point 2

HEX3_D[0]	PIN_B18	Seven Segment Digit 3[0]
HEX3_D[1]	PIN_F15	Seven Segment Digit 3[1]
HEX3_D[2]	PIN_A19	Seven Segment Digit 3[2]
HEX3_D[3]	PIN_B19	Seven Segment Digit 3[3]
HEX3_D[4]	PIN_C19	Seven Segment Digit 3[4]
HEX3_D[5]	PIN_D19	Seven Segment Digit 3[5]
HEX3_D[6]	PIN_G15	Seven Segment Digit 3[6]
HEX3_DP	PIN_G16	Seven Segment Decimal Point 3

### 4.4 Clock Circuitry

The DE0 board includes a 50 MHz clock signals. This clock signal is connected to the FPGA that are used for clocking the user logic. In addition, all these clock inputs are connected to the phase lock loops (PLL) clock input pin of the FPGA allowed users can use these clocks as a source clock for the PLL circuit.

The clock distribution on the DE0 board is shown in Figure 4-11. The associated pin assignments for clock inputs to FPGA I/O pins are listed in Table 4.5.

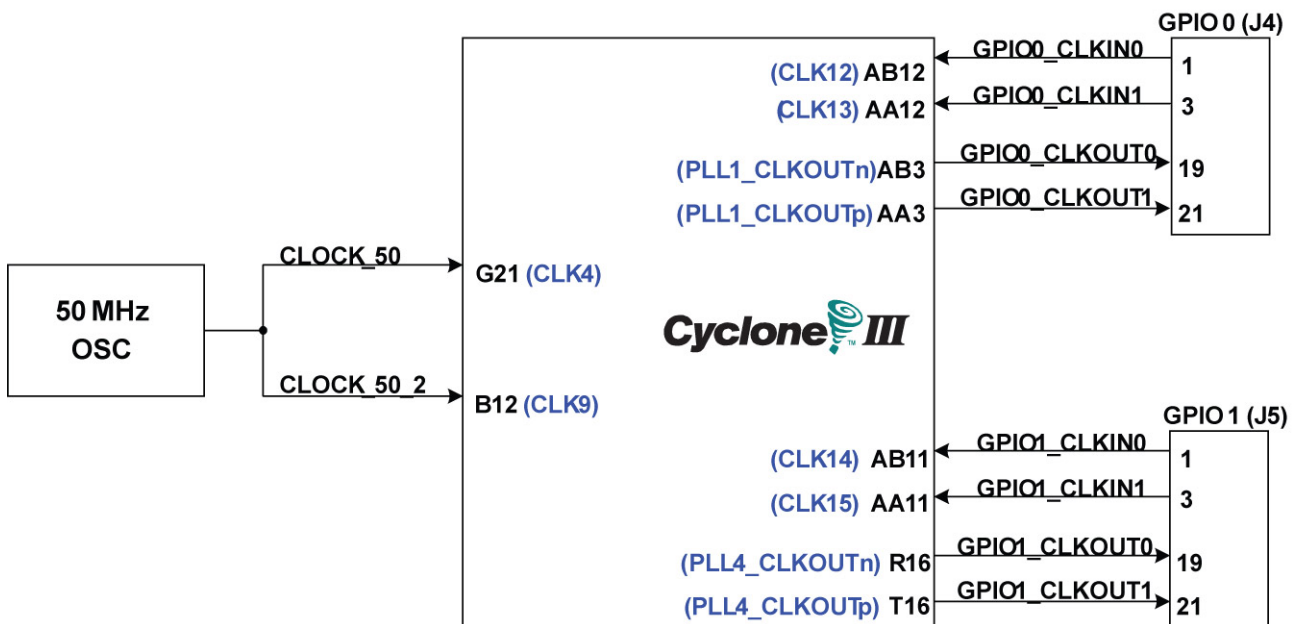

Figure 4-11 Block diagram of the clock distribution.

Table 4.5. Pin assignments for the clock inputs.

Signal Name	FPGA Pin No.	Description
CLOCK_50	PIN_G21	50 MHz clock input
CLOCK_50_2	PIN_B12	50 MHz clock input

## 4.5 Using the LCD Module

The DE0 board provides a 2x16 LCD interface. In order to use the LCD interface, users are required to solder a LCD module onto the DE0 board shown in [Figure 4-12](#). The detailed component reference is listed in [Table 4.6](#). **Also, users can buy this module from Terasic website (<http://de0.terasic.com>).**

Table 4.6. The listed information on the LCD module

Board Reference	Description
J2	2x16 LCD Module

The LCD module has built-in fonts and can be used to display text by sending appropriate commands to the display controller, which is called HD44780. Detailed information for using the display is available in its datasheet, which can be found on the manufacturer's web site, and from the *Datasheet/LCD* folder on the **DE0 System CD-ROM**. A schematic diagram of the LCD module showing connections to the Cyclone III FPGA is given in [Figure 4-13](#). The associated pin assignments appear in [Table 4.7](#).



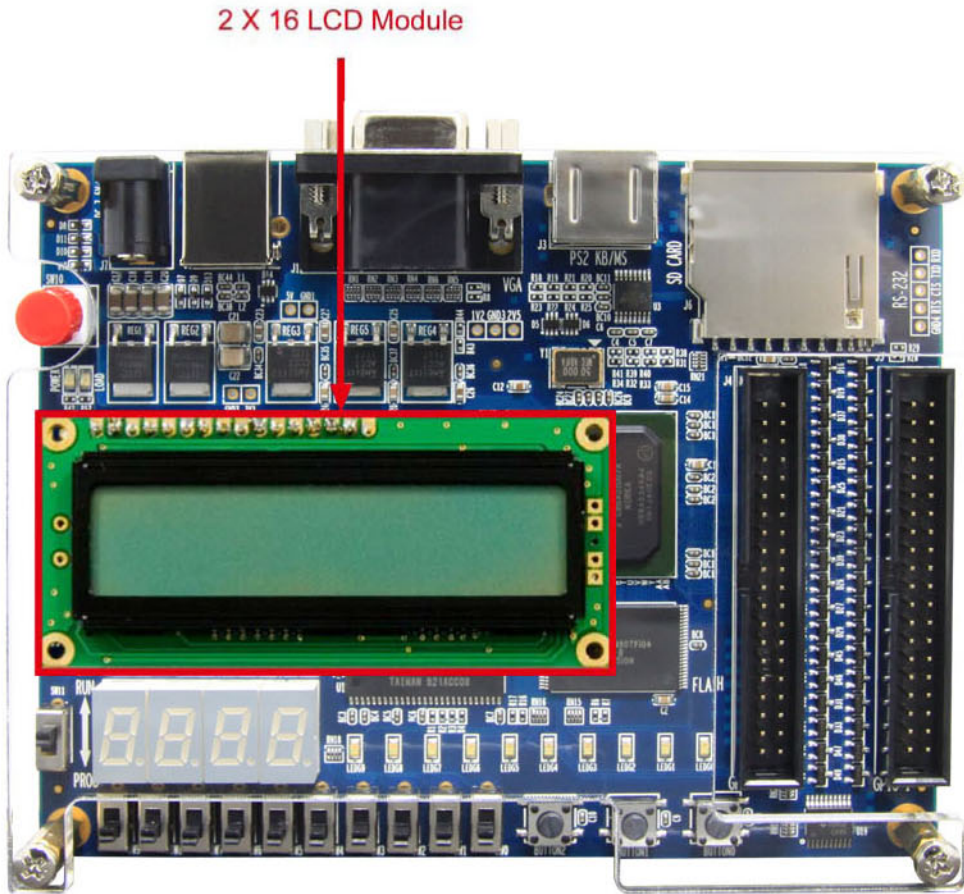

Figure 4-12 LCD module on DE0 board

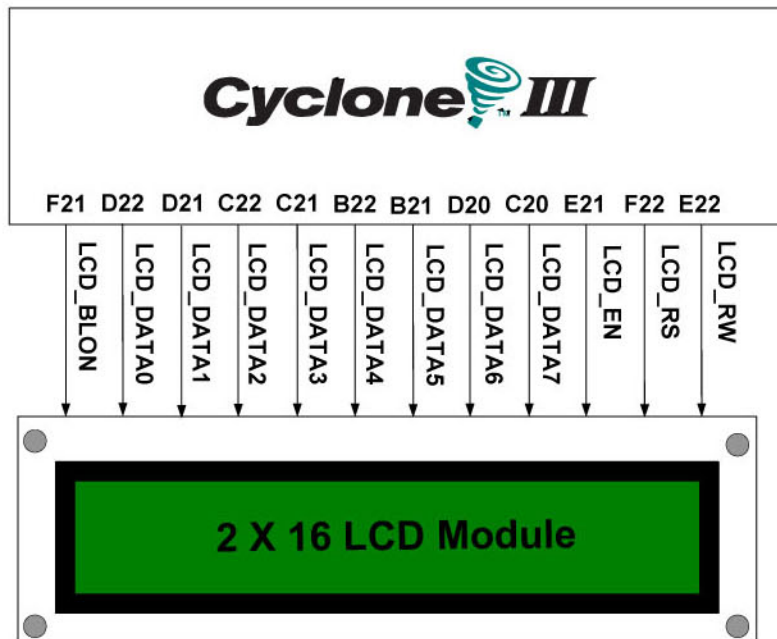

Figure 4-13 Connections between the LCD module and Cyclone III FPGA

Table 4.7. Pin assignments for the LCD module

Signal Name	FPGA Pin No.	Description
LCD_DATA[0]	PIN_D22	LCD Data[0]
LCD_DATA[1]	PIN_D21	LCD Data[1]
LCD_DATA[2]	PIN_C22	LCD Data[2]
LCD_DATA[3]	PIN_C21	LCD Data[3]
LCD_DATA[4]	PIN_B22	LCD Data[4]
LCD_DATA[5]	PIN_B21	LCD Data[5]
LCD_DATA[6]	PIN_D20	LCD Data[6]
LCD_DATA[7]	PIN_C20	LCD Data[7]
LCD_RW	PIN_E22	LCD Read/Write Select, 0 = Write, 1 = Read
LCD_EN	PIN_E21	LCD Enable
LCD_RS	PIN_F22	LCD Command/Data Select, 0 = Command, 1 = Data
LCD_BLON	PIN_F21	LCD Back Light ON/OFF

Note that some LCD modules do not have backlight. Therefore the LCD\_BLON signal should not be used in users' design projects.

## 4.6 Using the Expansion Header

The DE0 Board provides two 40-pin expansion headers. Each header connects directly to 36 pins of the Cyclone III FPGA, and also provides DC +5V (VCC5), DC +3.3V (VCC33), and two GND pins. Among these 36 I/O pins, 4 pins are connected to the PLL clock input and output pins of the FPGA allowing the expansion daughter cards to access the PLL blocks in the FPGA.

Finally, Figure 4-14 shows the related schematics. The figure shows the protection circuitry for only two of the pins on each header, but this circuitry is included for all 72 data pins. [Table 4.8](#) gives the pin assignments.

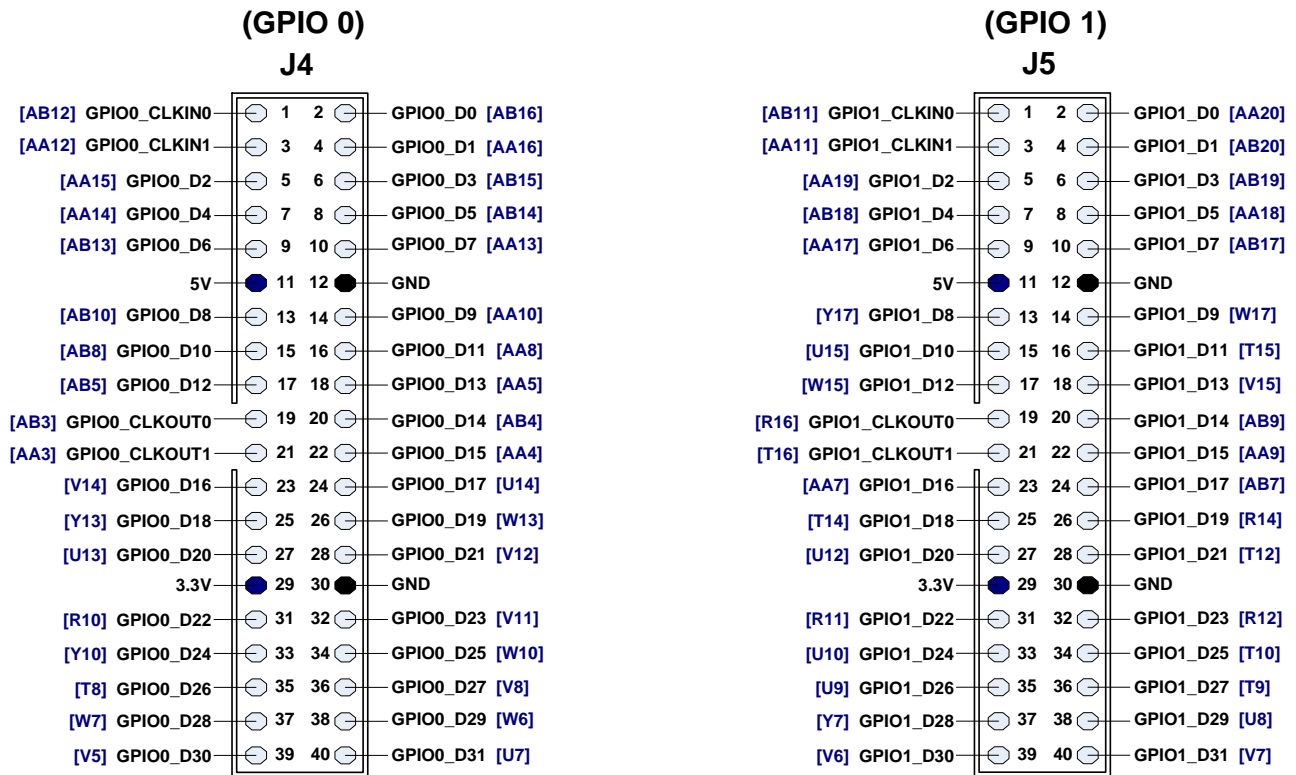

Figure 4-14 I/O distribution of the expansion headers

Table 4.8. Pin assignments for the expansion headers.

Signal Name	FPGA Pin No.	Description
GPIO0_D[0]	PIN_AB16	GPIO Connection 0 IO[0]
GPIO0_D[1]	PIN_AA16	GPIO Connection 0 IO[1]
GPIO0_D[2]	PIN_AA15	GPIO Connection 0 IO[2]
GPIO0_D[3]	PIN_AB15	GPIO Connection 0 IO[3]
GPIO0_D[4]	PIN_AA14	GPIO Connection 0 IO[4]
GPIO0_D[5]	PIN_AB14	GPIO Connection 0 IO[5]
GPIO0_D[6]	PIN_AB13	GPIO Connection 0 IO[6]
GPIO0_D[7]	PIN_AA13	GPIO Connection 0 IO[7]
GPIO0_D[8]	PIN_AB10	GPIO Connection 0 IO[8]
GPIO0_D[9]	PIN_AA10	GPIO Connection 0 IO[9]
GPIO0_D[10]	PIN_AB8	GPIO Connection 0 IO[10]
GPIO0_D[11]	PIN_AA8	GPIO Connection 0 IO[11]
GPIO0_D[12]	PIN_AB5	GPIO Connection 0 IO[12]
GPIO0_D[13]	PIN_AA5	GPIO Connection 0 IO[13]
GPIO0_D[14]	PIN_AB4	GPIO Connection 0 IO[14]
GPIO0_D[15]	PIN_AA4	GPIO Connection 0 IO[15]

GPIO0_D[16]	PIN_V14	GPIO Connection 0 IO[16]
GPIO0_D[17]	PIN_U14	GPIO Connection 0 IO[17]
GPIO0_D[18]	PIN_Y13	GPIO Connection 0 IO[18]
GPIO0_D[19]	PIN_W13	GPIO Connection 0 IO[19]
GPIO0_D[20]	PIN_U13	GPIO Connection 0 IO[20]
GPIO0_D[21]	PIN_V12	GPIO Connection 0 IO[21]
GPIO0_D[22]	PIN_R10	GPIO Connection 0 IO[22]
GPIO0_D[23]	PIN_V11	GPIO Connection 0 IO[23]
GPIO0_D[24]	PIN_Y10	GPIO Connection 0 IO[24]
GPIO0_D[25]	PIN_W10	GPIO Connection 0 IO[25]
GPIO0_D[26]	PIN_T8	GPIO Connection 0 IO[26]
GPIO0_D[27]	PIN_V8	GPIO Connection 0 IO[27]
GPIO0_D[28]	PIN_W7	GPIO Connection 0 IO[28]
GPIO0_D[29]	PIN_W6	GPIO Connection 0 IO[29]
GPIO0_D[30]	PIN_V5	GPIO Connection 0 IO[30]
GPIO0_D[31]	PIN_U7	GPIO Connection 0 IO[31]
GPIO0_CLKIN[0]	PIN_AB12	GPIO Connection 0 PLL In
GPIO0_CLKIN[1]	PIN_AA12	GPIO Connection 0 PLL In
GPIO0_CLKOUT[0]	PIN_AB3	GPIO Connection 0 PLL Out
GPIO0_CLKOUT[1]	PIN_AA3	GPIO Connection 0 PLL Out
GPIO1_D[0]	PIN_AA20	GPIO Connection 1 IO[0]
GPIO1_D[1]	PIN_AB20	GPIO Connection 1 IO[1]
GPIO1_D[2]	PIN_AA19	GPIO Connection 1 IO[2]
GPIO1_D[3]	PIN_AB19	GPIO Connection 1 IO[3]
GPIO1_D[4]	PIN_AB18	GPIO Connection 1 IO[4]
GPIO1_D[5]	PIN_AA18	GPIO Connection 1 IO[5]
GPIO1_D[6]	PIN_AA17	GPIO Connection 1 IO[6]
GPIO1_D[7]	PIN_AB17	GPIO Connection 1 IO[7]
GPIO1_D[8]	PIN_Y17	GPIO Connection 1 IO[8]
GPIO1_D[9]	PIN_W17	GPIO Connection 1 IO[9]
GPIO1_D[10]	PIN_U15	GPIO Connection 1 IO[10]
GPIO1_D[11]	PIN_T15	GPIO Connection 1 IO[11]
GPIO1_D[12]	PIN_W15	GPIO Connection 1 IO[12]
GPIO1_D[13]	PIN_V15	GPIO Connection 1 IO[13]
GPIO1_D[14]	PIN_AB9	GPIO Connection 1 IO[14]
GPIO1_D[15]	PIN_AA9	GPIO Connection 1 IO[15]
GPIO1_D[16]	PIN_AA7	GPIO Connection 1 IO[16]

GPIO1_D[17]	PIN_AB7	GPIO Connection 1 IO[17]
GPIO1_D[18]	PIN_T14	GPIO Connection 1 IO[18]
GPIO1_D[19]	PIN_R14	GPIO Connection 1 IO[19]
GPIO1_D[20]	PIN_U12	GPIO Connection 1 IO[20]
GPIO1_D[21]	PIN_T12	GPIO Connection 1 IO[21]
GPIO1_D[22]	PIN_R11	GPIO Connection 1 IO[22]
GPIO1_D[23]	PIN_R12	GPIO Connection 1 IO[23]
GPIO1_D[24]	PIN_U10	GPIO Connection 1 IO[24]
GPIO1_D[25]	PIN_T10	GPIO Connection 1 IO[25]
GPIO1_D[26]	PIN_U9	GPIO Connection 1 IO[26]
GPIO1_D[27]	PIN_T9	GPIO Connection 1 IO[27]
GPIO1_D[28]	PIN_Y7	GPIO Connection 1 IO[28]
GPIO1_D[29]	PIN_U8	GPIO Connection 1 IO[29]
GPIO1_D[30]	PIN_V6	GPIO Connection 1 IO[30]
GPIO1_D[31]	PIN_V7	GPIO Connection 1 IO[31]
GPIO1_CLKIN[0]	PIN_AB11	GPIO Connection 1 PLL In
GPIO1_CLKIN[1]	PIN_AA11	GPIO Connection 1 PLL In
GPIO1_CLKOUT[0]	PIN_R16	GPIO Connection 1 PLL Out
GPIO1_CLKOUT[1]	PIN_T16	GPIO Connection 1 PLL Out

## 4.7 Using VGA

The DE0 board includes a 16-pin D-SUB connector for VGA output. The VGA synchronization signals are provided directly from the Cyclone III FPGA, and a 4-bit DAC using resistor network is used to produce the analog data signals (red, green, and blue). The associated schematic is given in [Figure 4-15](#) and can support standard VGA resolution (640x480 pixels, at 25 MHz).

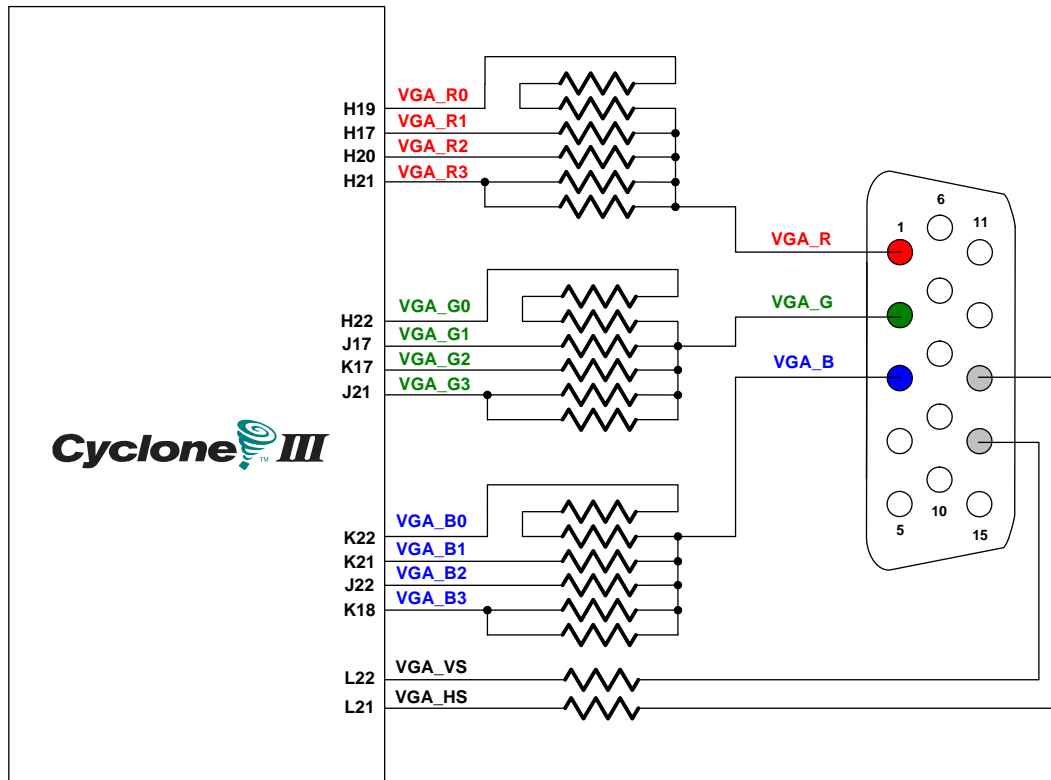

Figure 4-15 Connections between VGA circuit and Cyclone III FPGA

The timing specification for VGA synchronization and RGB (red, green, blue) data can be found on various educational web sites (for example, search for “VGA signal timing”). Figure 4-16 illustrates the basic timing requirements for each row (horizontal) that is displayed on a VGA monitor. An active-low pulse of specific duration (time *a* in the figure) is applied to the horizontal synchronization (*hsync*) input of the monitor, which signifies the end of one row of data and the start of the next. The data (RGB) inputs on the monitor must be off (driven to 0 V) for a time period called the *back porch* (*b*) after the *hsync* pulse occurs, which is followed by the display interval (*c*). During the data display interval the RGB data drives each pixel in turn across the row being displayed. Finally, there is a time period called the *front porch* (*d*) where the RGB signals must again be off before the next *hsync* pulse can occur. The timing of the vertical synchronization (*vsync*) is the same as shown in Figure 4-16, except that a *vsync* pulse signifies the end of one frame and the start of the next, and the data refers to the set of rows in the frame (horizontal timing). Table 4.9 and Table 4.10 show different resolutions of the durations of time periods *a*, *b*, *c*, and *d* for both horizontal and vertical timing.

Detailed information for using the ADV7123 video DAC is available in its datasheet, which can be found on the manufacturer's web site, or in the *Datasheet/VGA DAC* folder on the **DE0 System CD-ROM**. The pin assignments between the Cyclone III FPGA and the VGA connector are listed in Table 4.11. An example of code that drives a VGA display is described in Sections 5.3.

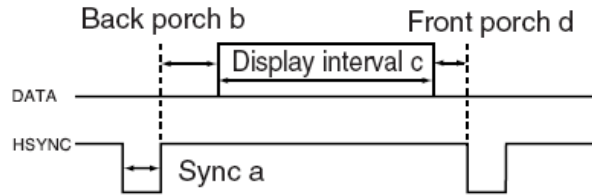

Figure 4-16 VGA horizontal timing specification

Table 4.9. VGA horizontal timing specification

VGA mode		Horizontal Timing Spec				
Configuration	Resolution(HxV)	a(us)	b(us)	c(us)	d(us)	Pixel clock(Mhz)
VGA(60Hz)	640x480	3.8	1.9	25.4	0.6	25 (640/c)

Table 4.10. VGA vertical timing specification

VGA mode		Vertical Timing Spec			
Configuration	Resolution (HxV)	a(lines)	b(lines)	c(lines)	d(lines)
VGA(60Hz)	640x480	2	33	480	10

Table 4.11. VGA pin assignments

Signal Name	FPGA Pin No.	Description
VGA_R[0]	PIN_H19	VGA Red[0]
VGA_R[1]	PIN_H17	VGA Red[1]
VGA_R[2]	PIN_H20	VGA Red[2]
VGA_R[3]	PIN_H21	VGA Red[3]
VGA_G[0]	PIN_H22	VGA Green[0]
VGA_G[1]	PIN_J17	VGA Green[1]
VGA_G[2]	PIN_K17	VGA Green[2]
VGA_G[3]	PIN_J21	VGA Green[3]
VGA_B[0]	PIN_K22	VGA Blue[0]
VGA_B[1]	PIN_K21	VGA Blue[1]
VGA_B[2]	PIN_J22	VGA Blue[2]
VGA_B[3]	PIN_K18	VGA Blue[3]
VGA_HS	PIN_L21	VGA H_SYNC
VGA_VS	PIN_L22	VGA V_SYNC

### 4.8 RS-232 Serial Port

The DE0 board uses the ADM3202 transceiver chip for RS-232 communications. Please note that the associated RS232 signals are connected to use as test point as shown in Figure 4-17. To use this interface, users need to connect these signals to 9-pin D-sub connector or RS232 cable. For detailed information on how to use the transceiver refer to the datasheet, which is available on the manufacturer’s web site, or in the *Datasheet/RS232* folder on the **DE0 System CD-ROM**. Figure 4-18 shows the related schematics, and Table 4.12 lists the Cyclone III FPGA pin assignments with the RS-232 serial port.

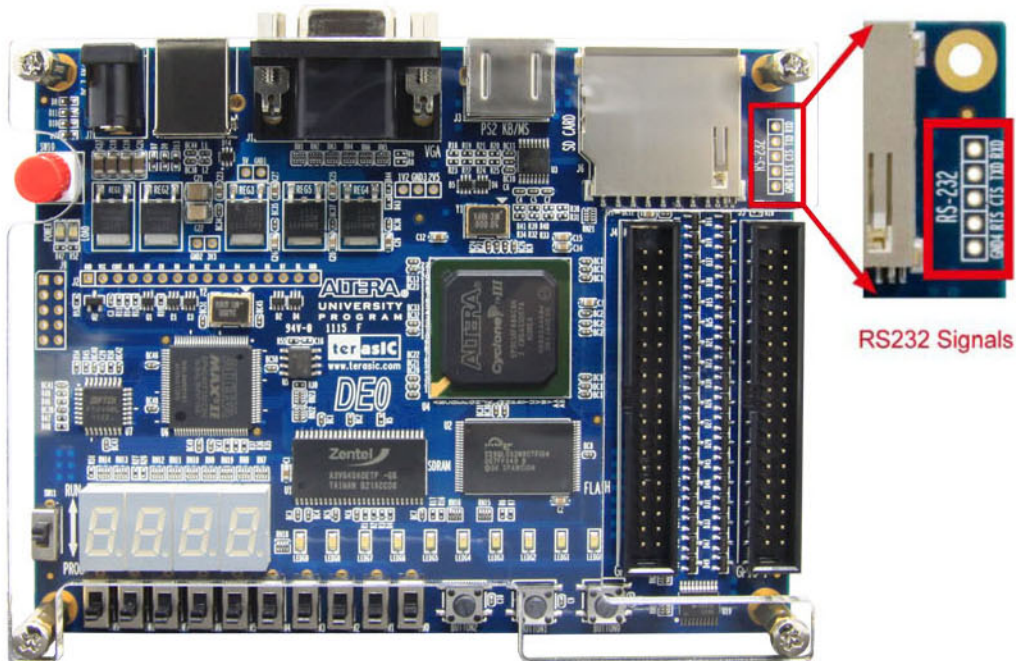

Figure 4-17 The placement of the RS232 signals

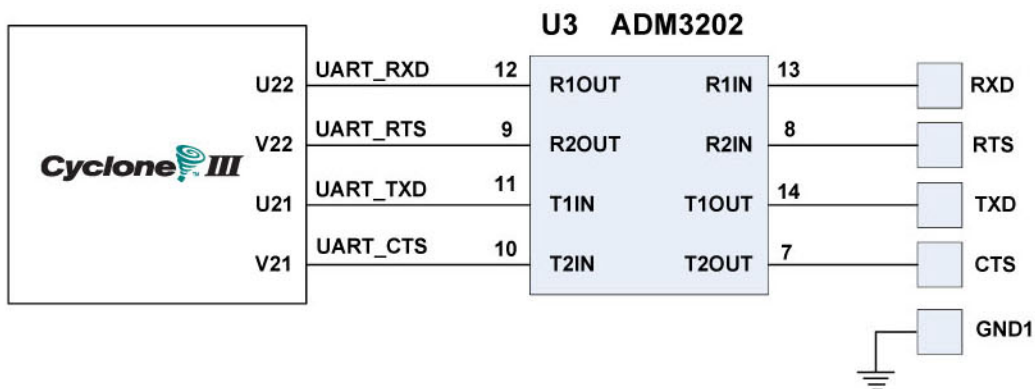

Figure 4-18 Connections between the ADM232 (RS-232) chip and Cyclone III FPGA



Table 4.12. RS-232 pin assignments

Signal Name	FPGA Pin No.	Description
UART_RXD	PIN_U22	UART Receiver
UART_TXD	PIN_U21	UART Transmitter
UART_CTS	PIN_V21	UART Clear to Send
UART_RTS	PIN_V22	UART Request to Send

## 4.9 PS/2 Serial Port

The DE0 board includes a standard PS/2 interface and a connector for a PS/2 keyboard or mouse. In addition, users can use the PS/2 keyboard and mouse on the DE0 board simultaneously by plugging an extension PS/2 Y-Cable. Note that both the *PS\_MSDAT* and *PS\_MSCLK* signals can be used only when the PS/2 Y-cable is connected to the PS/2 connector. Figure 4-19 shows the connections between the PS/2 circuit and FPGA. Instructions for using a PS/2 mouse or keyboard can be found by performing an appropriate search on various educational web sites. The pin assignments for the associated interface are shown in Table 4.13.

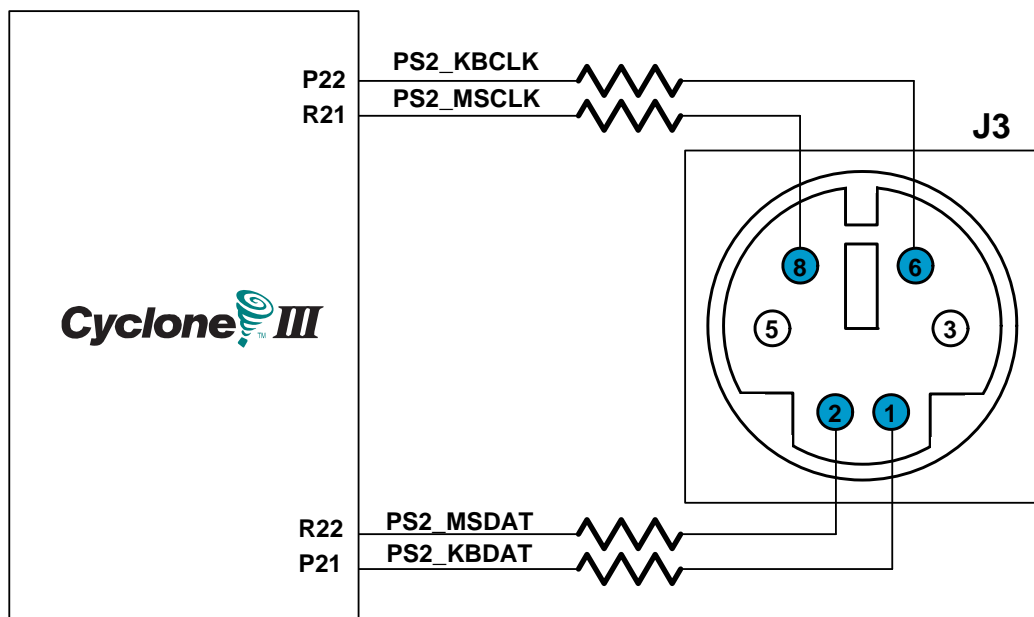

Figure 4-19 Connections between PS/2 and Cyclone III FPGA

Table 4.13. PS/2 pin assignments

Signal Name	FPGA Pin No.	Description
PS2_KBCLK	PIN_P22	PS/2 Clock
PS2_KBDAT	PIN_P21	PS/2 Data
PS2_MSCLK	PIN_R21	PS/2 Clock (reserved for second PS/2 device)
PS2_MSDAT	PIN_R22	PS/2 Data(reserved for second PS/2 device)

## 4.10 SD Card Socket

The DE0 board has a SD card socket and can be accessed as optional external memory in both SPI and 1-bit SD mode. Table 4.14 shows the pin assignments for the SD card socket with the Cyclone III FPGA.

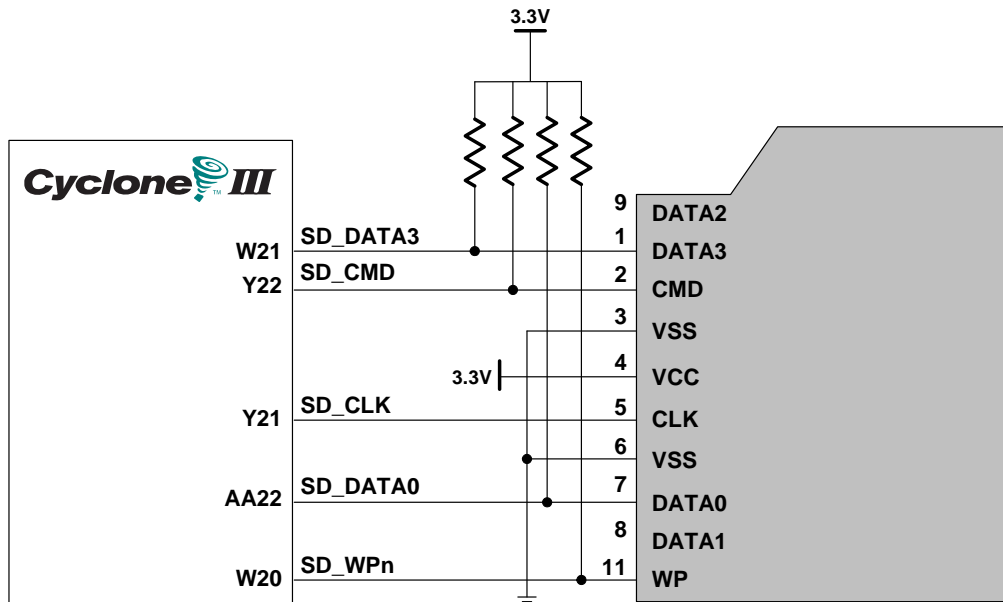

Figure 4-20 Connections between SD Card and Cyclone III FPGA

Table 4.14. SD Card pin assignments

Signal Name	FPGA Pin No.	Description
SD_CLK	PIN_Y21	SD Clock
SD_CMD	PIN_Y22	SD Command bidirectional signal
SD_DAT0	PIN_AA22	SD Data bidirectional signal
SD_DAT3	PIN_W21	SD Data bidirectional signal
SD_WP_N	PIN_W20	SD Card write protect signal (active low)

## 4.11 Using SDRAM and Flash

The DE0 board provides a 4-Mbyte Flash memory, and 8-Mbyte SDRAM chips. Figure 4-21 and Figure 4-22 show the connections between the memory chips and Cyclone III FPGA. The pin assignments for each device are listed in Tables 4.15 and 4.16. The datasheets for the memory chips are provided in the *Datasheet/Memory* folder on the **DE0 System CD-ROM**.

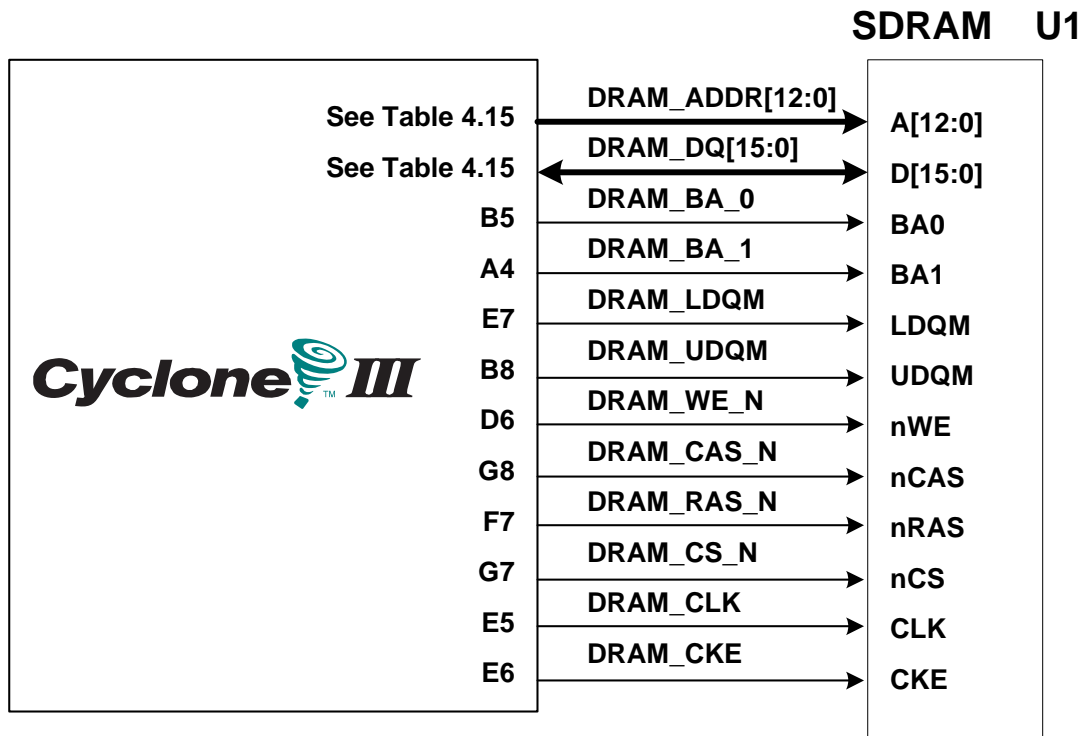

Figure 4-21 Connections between SDRAM and Cyclone III FPGA

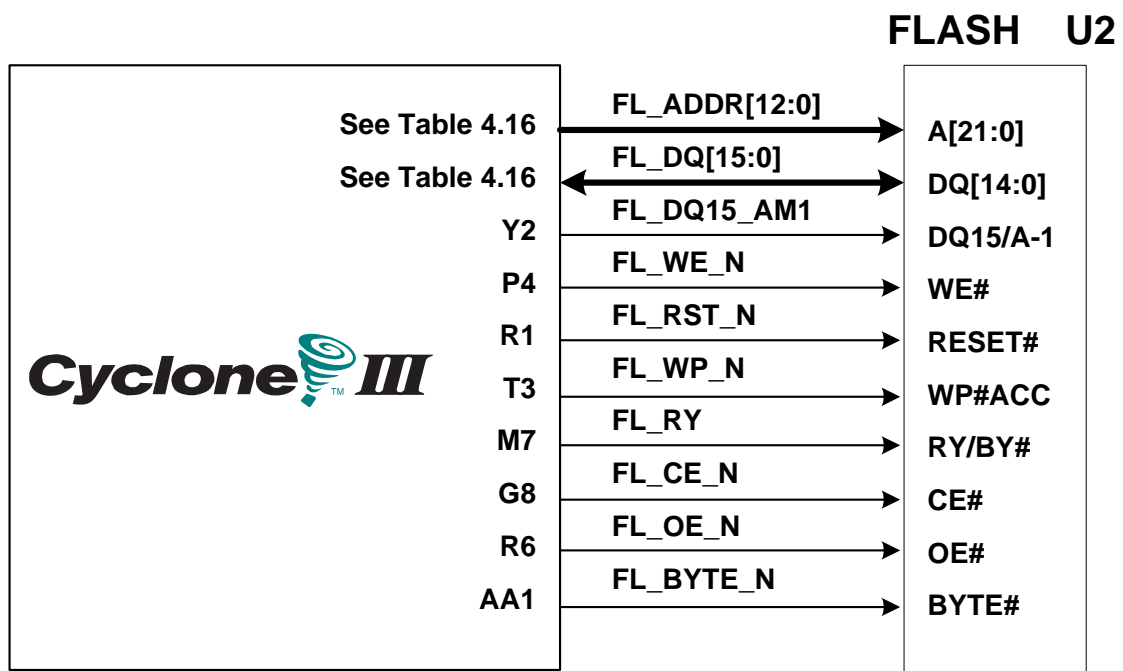

Figure 4-22 Connections between Flash and Cyclone III FPGA

Table 4.15. SDRAM pin assignments

Signal Name	FPGA Pin No.	Description
DRAM_ADDR[0]	PIN_C4	SDRAM Address[0]
DRAM_ADDR[1]	PIN_A3	SDRAM Address[1]
DRAM_ADDR[2]	PIN_B3	SDRAM Address[2]
DRAM_ADDR[3]	PIN_C3	SDRAM Address[3]
DRAM_ADDR[4]	PIN_A5	SDRAM Address[4]
DRAM_ADDR[5]	PIN_C6	SDRAM Address[5]
DRAM_ADDR[6]	PIN_B6	SDRAM Address[6]
DRAM_ADDR[7]	PIN_A6	SDRAM Address[7]
DRAM_ADDR[8]	PIN_C7	SDRAM Address[8]
DRAM_ADDR[9]	PIN_B7	SDRAM Address[9]
DRAM_ADDR[10]	PIN_B4	SDRAM Address[10]
DRAM_ADDR[11]	PIN_A7	SDRAM Address[11]
DRAM_ADDR[12]	PIN_C8	SDRAM Address[12]
DRAM_DQ[0]	PIN_D10	SDRAM Data[0]
DRAM_DQ[1]	PIN_G10	SDRAM Data[1]
DRAM_DQ[2]	PIN_H10	SDRAM Data[2]
DRAM_DQ[3]	PIN_E9	SDRAM Data[3]
DRAM_DQ[4]	PIN_F9	SDRAM Data[4]
DRAM_DQ[5]	PIN_G9	SDRAM Data[5]
DRAM_DQ[6]	PIN_H9	SDRAM Data[6]
DRAM_DQ[7]	PIN_F8	SDRAM Data[7]
DRAM_DQ[8]	PIN_A8	SDRAM Data[8]
DRAM_DQ[9]	PIN_B9	SDRAM Data[9]
DRAM_DQ[10]	PIN_A9	SDRAM Data[10]
DRAM_DQ[11]	PIN_C10	SDRAM Data[11]
DRAM_DQ[12]	PIN_B10	SDRAM Data[12]
DRAM_DQ[13]	PIN_A10	SDRAM Data[13]
DRAM_DQ[14]	PIN_E10	SDRAM Data[14]
DRAM_DQ[15]	PIN_F10	SDRAM Data[15]
DRAM_BA_0	PIN_B5	SDRAM Bank Address[0]
DRAM_BA_1	PIN_A4	SDRAM Bank Address[1]
DRAM_LDQM	PIN_E7	SDRAM Low-byte Data Mask
DRAM_UDQM	PIN_B8	SDRAM High-byte Data Mask
DRAM_RAS_N	PIN_F7	SDRAM Row Address Strobe
DRAM_CAS_N	PIN_G8	SDRAM Column Address Strobe

DRAM_CKE	PIN_E6	SDRAM Clock Enable
DRAM_CLK	PIN_E5	SDRAM Clock
DRAM_WE_N	PIN_D6	SDRAM Write Enable
DRAM_CS_N	PIN_G7	SDRAM Chip Select

Table 4.16. Flash pin assignments

Signal Name	FPGA Pin No.	Description
FL_ADDR[0]	PIN_P7	FLASH Address[0]
FL_ADDR[1]	PIN_P5	FLASH Address[1]
FL_ADDR[2]	PIN_P6	FLASH Address[2]
FL_ADDR[3]	PIN_N7	FLASH Address[3]
FL_ADDR[4]	PIN_N5	FLASH Address[4]
FL_ADDR[5]	PIN_N6	FLASH Address[5]
FL_ADDR[6]	PIN_M8	FLASH Address[6]
FL_ADDR[7]	PIN_M4	FLASH Address[7]
FL_ADDR[8]	PIN_P2	FLASH Address[8]
FL_ADDR[9]	PIN_N2	FLASH Address[9]
FL_ADDR[10]	PIN_N1	FLASH Address[10]
FL_ADDR[11]	PIN_M3	FLASH Address[11]
FL_ADDR[12]	PIN_M2	FLASH Address[12]
FL_ADDR[13]	PIN_M1	FLASH Address[13]
FL_ADDR[14]	PIN_L7	FLASH Address[14]
FL_ADDR[15]	PIN_L6	FLASH Address[15]
FL_ADDR[16]	PIN_AA2	FLASH Address[16]
FL_ADDR[17]	PIN_M5	FLASH Address[17]
FL_ADDR[18]	PIN_M6	FLASH Address[18]
FL_ADDR[19]	PIN_P1	FLASH Address[19]
FL_ADDR[20]	PIN_P3	FLASH Address[20]
FL_ADDR[21]	PIN_R2	FLASH Address[21]
FL_DQ[0]	PIN_R7	FLASH Data[0]
FL_DQ[1]	PIN_P8	FLASH Data[1]
FL_DQ[2]	PIN_R8	FLASH Data[2]
FL_DQ[3]	PIN_U1	FLASH Data[3]
FL_DQ[4]	PIN_V2	FLASH Data[4]
FL_DQ[5]	PIN_V3	FLASH Data[5]
FL_DQ[6]	PIN_W1	FLASH Data[6]

FL_DQ[7]	PIN_Y1	FLASH Data[7]
FL_DQ[8]	PIN_T5	FLASH Data[8]
FL_DQ[9]	PIN_T7	FLASH Data[9]
FL_DQ[10]	PIN_T4	FLASH Data[10]
FL_DQ[11]	PIN_U2	FLASH Data[11]
FL_DQ[12]	PIN_V1	FLASH Data[12]
FL_DQ[13]	PIN_V4	FLASH Data[13]
FL_DQ[14]	PIN_W2	FLASH Data[14]
FL_DQ15_AM1	PIN_Y2	FLASH Data[15]
FL_BYTE_N	PIN_AA1	FLASH Byte/Word Mode Configuration
FL_CE_N	PIN_N8	FLASH Chip Enable
FL_OE_N	PIN_R6	FLASH Output Enable
FL_RST_N	PIN_R1	FLASH Reset
FL_RY	PIN_M7	LASH Ready/Busy output
FL_WE_N	PIN_P4	FLASH Write Enable
FL_WP_N	PIN_T3	FLASH Write Protect /Programming Acceleration

# Chapter 5

## Examples of Advanced Demonstrations

This chapter provides a number of examples of advanced circuits implemented on the DE0 board. These circuits provide demonstrations of the major features on the board, such as its video capabilities and SD card storage. For each demonstration the Cyclone III FPGA (or EPCS4 serial EEPROM) configuration file is provided, as well as the full source code in Verilog HDL code. All of the associated files can be found in the *DE0\ demonstrations* folder from the **DE0 System CD-ROM**. For each of demonstrations described in the following sections, we give the name of the project directory for its files, which are subdirectories of the *DE0\_demonstrations* folder.

### Installing the Demonstrations

To install the demonstrations on your computer, perform the following

1. Copy the directory *DE0\_demonstrations* into a local directory of your choice. **It is important to ensure that the path to your local directory contains no spaces – otherwise, the Nios II software will not work.**

### 5.1 DE0 Factory Configuration

The DE0 board is shipped from the factory with a default configuration that demonstrates some of the basic features of the board. The setup required for this demonstration, and the locations of its files are shown below.

#### Demonstration Setup, File Locations, and Instructions

- Project directory: *DE0\_Default*
- Bit stream used: *DE0\_Default.sof* or *DE0\_Default.pof*
- Power on the DE0 board, with the USB cable connected to the USB Blaster port. If necessary (that is, if the default factory configuration of the DE0 board is not currently stored in EPCS4 device), download the bit stream to the board by using either JTAG or AS programming
- You should now be able to observe that the 7-segment displays are displaying a sequence of characters, and green LEDs are flashing.
- Optionally connect a VGA display to the VGA D-SUB connector. When connected, the VGA display should show a pattern of colors

The Verilog source code for this demonstration is provided in the *DE0\_Default* folder, which also includes the necessary files for the corresponding Quartus II project. The top-level Verilog file, called *DE0\_Default.v*, can be used as a template for other projects, because it defines ports that correspond to all of the user-accessible pins on the Cyclone III FPGA.

## 5.2 SD Card

Many applications use a large external storage device, such as a SD card or CF card, to store data. The DE0 board provides the hardware and software needed for SD card access. In this demonstration we will show how to browse files stored in the root directory of a SD card and how to read the file contents of a specific file. The size of the SD card should be less or equal to 2GB. Also, it is required to be formatted as FAT (FAT16 or FAT 32) File System in advance. Long file name is supported in this demonstration.

Figure 5-1 shows the hardware system block diagram of this demonstration. The system requires a 50 MHz clock provided from the board. Four PIO pins are connected to the SD card socket. They are SD\_CLK, SD\_CMD, SD\_DAT and SD\_WP\_N. The three pins SD\_CLK, SD\_CMD and SD\_DAT are used to implement SD 1-bit Mode protocol for accessing the SD card content. The SD 1-bit protocol and FAT File System function are all implemented by NIOS II software. The software is stored in the on-board SDRAM memory.

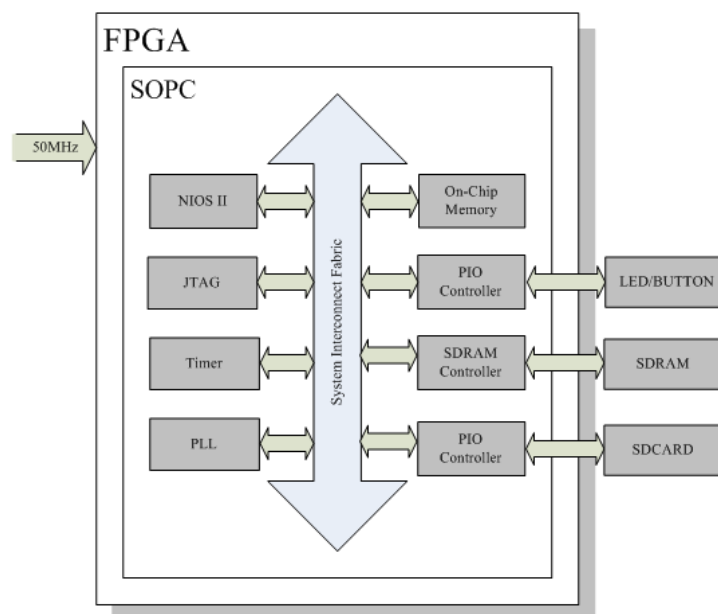

Figure 5-1 Block Diagram of the SD Card Demonstration

Figure 5-2 shows the software stack of this demonstration. The NIOS PIO block provides basic IO functions to access hardware directly. The functions are provided from NIOS II system and the



function prototype is defined in the header file `<io.h>`. The SD-CARD block implements SD 1-bit mode protocol for communication with the SD card. The FAT File System block implements reading function for FAT16 and FAT 32 file system. Long filename is supported. By calling the exported FAT functions, users can browse files under the root directory of the SD card. Furthermore, users can open a specified file and read the contents of the file.

The main block implements main control of this demonstration. When the program is executed, it detects whether a SD card is inserted. If a SD card is found, it will check whether the SD card is formatted as FAT file system. If a FAT file system is found, it searches all files in the root directory of the FAT file system and displays their names in the `nios2-terminal`. If a text file named “test.txt” is found, it will dump the file contents. If it successfully recognizes the FAT file system, it will turn on the all of green LED. On the other hand, it will turn off all of the green LED if it fails to parse the FAT file system. Half number of the green LED will be turn on if there is no SD card found in the SD Card socket. If users press `BUTTON2` of the DE0 board, the program will perform above process again.

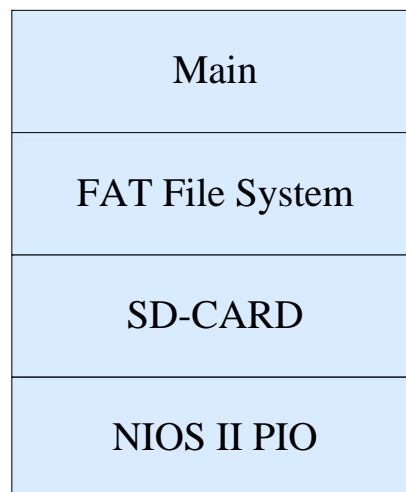

Figure 5-2. Clock Diagram of the SD Card Demonstration

## ■ Demonstration Source Code

- Project directory: `DE0_NIOS_SDCARD`
- Bit stream used: `DE0_TOP_SDCARD.sof`
- NIOS II Workspace: `DE0_NIOS_SDCARD\Software`

## ■ Demonstration Batch File

Demo Batch File Folder: *DE0\_NIOS\_SDCARD \Demo\_Batch*

The demo batch file includes following files:

- Batch File: test.bat, test\_bashrc
- FPGA Configure File: DE0\_TOP\_SDCARD.sof
- NIOS II Program: DE0\_SDCARD.elf

## ■ Demonstration Setup

- Make sure Quartus II and NIOS II are installed on your PC.
- Change Switch to “PROG” Mode to “RUN” mode in DE0 board.
- Power on the DE0 board.
- Connect USB Blaster to the DE0 board and install USB Blaster driver if necessary.
- Execute the demo batch file “*test.bat*” under the batch file folder, *DE0\_NIOS\_SDCARD\demo\_batch*.
- After NIOS II program is downloaded and executed successfully, a prompt message will be displayed in nios2-terminal
- Copy test files to the root directory of the SD Card.
- Insert the SD card into the SD Card socket of DE0, as shown in [Figure 5-3](#).
- Press **Button2** of the DE0 board to start reading SD Card.
- The program will display SD Card information, as shown in [Figure 5-4](#).

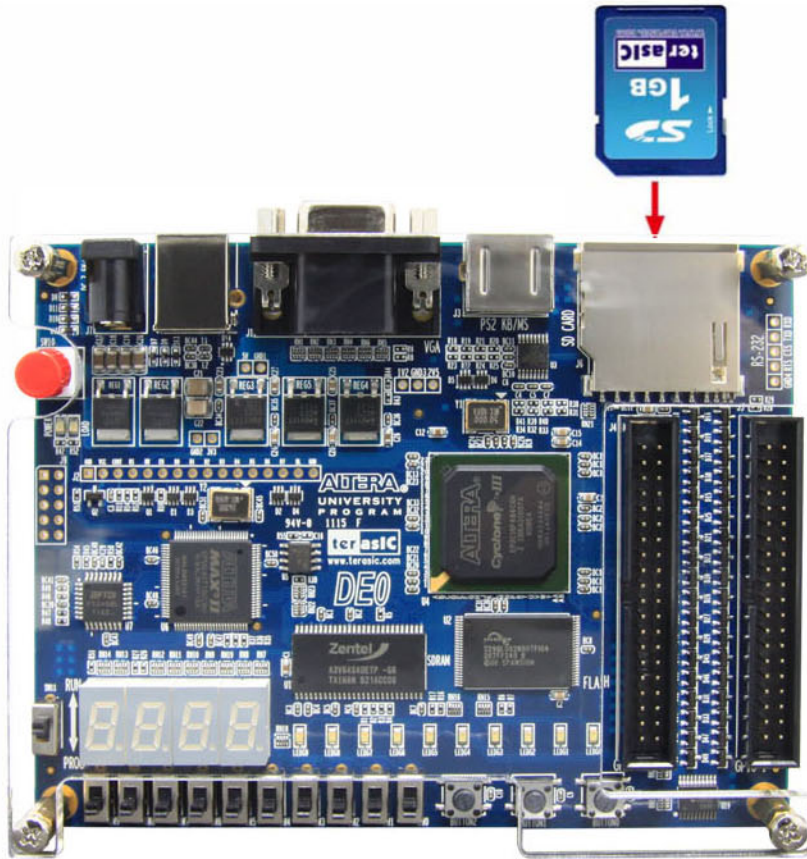

Figure 5-3. Insert SD Card for the SD-Card Demonstration



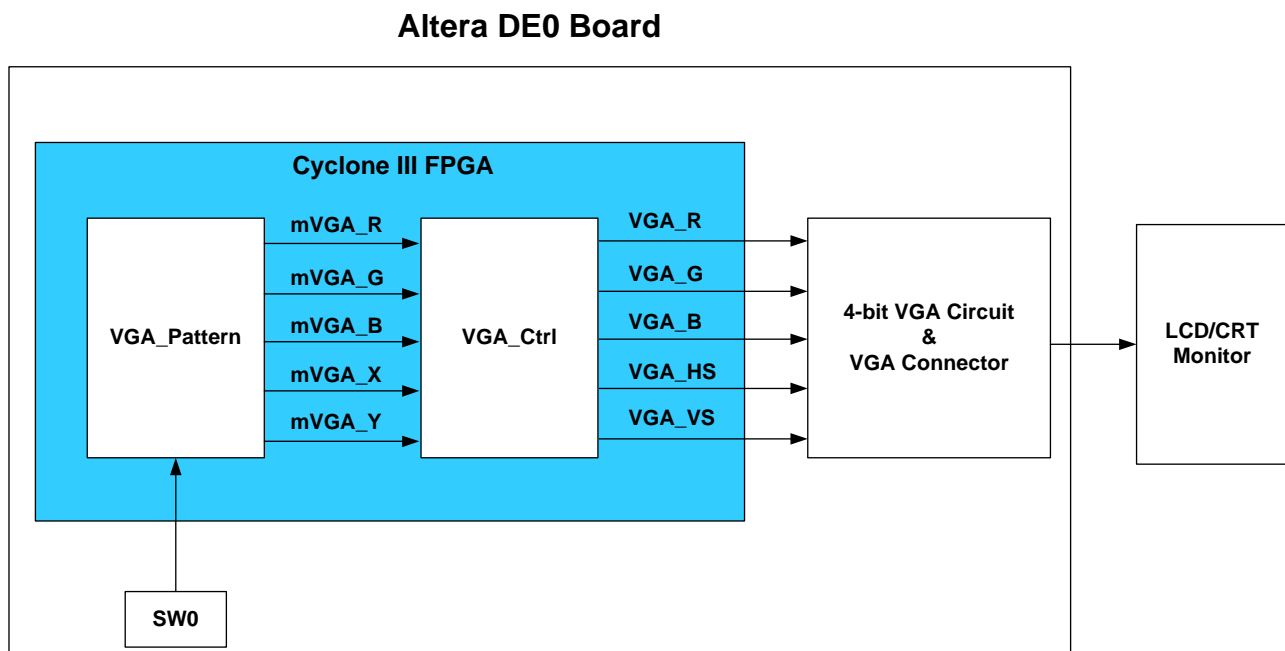

Figure 5-5. Block diagram of the VGA Color Pattern demonstration.

### Demonstration Setup, File Locations, and Instructions

- Project directory: *DE0\_VGA*
- Bit stream used: *DE0\_VGA.sof* or *DE0\_VGA.pof*
- Connect the VGA output of the DE0 board to a VGA monitor (both LCD and CRT type of monitors should work)
- Load the bit stream into FPGA.
- The LCD/CRT monitor should display the color pattern as shown in [Figure 5-6](#).
- Switch SW0 can change the color pattern (see [Figure 5-7](#)).

[Figure 5-6](#) illustrates the setup for this demonstration.

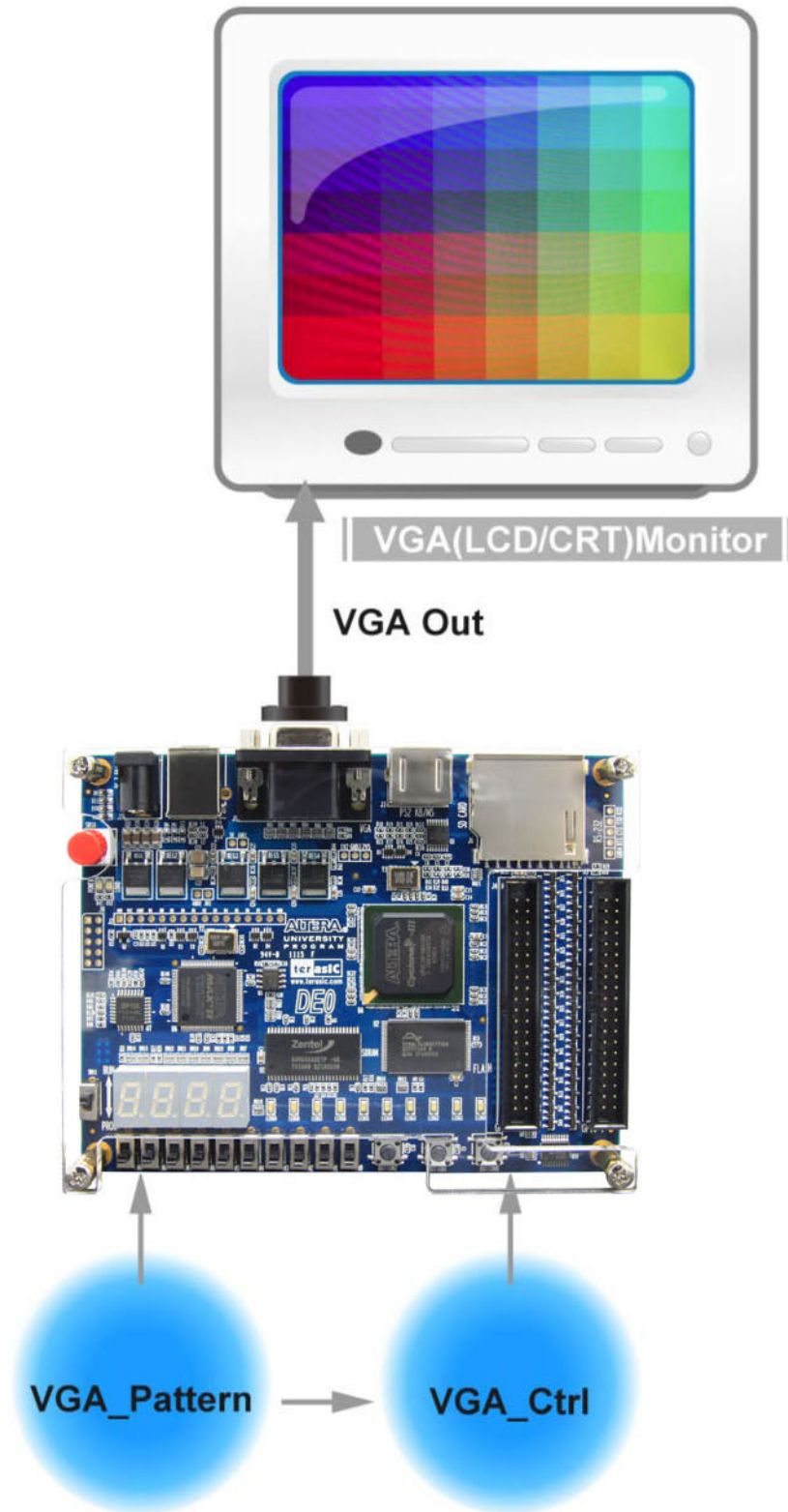

Figure 5-6. The setup for the VGA color pattern demonstration

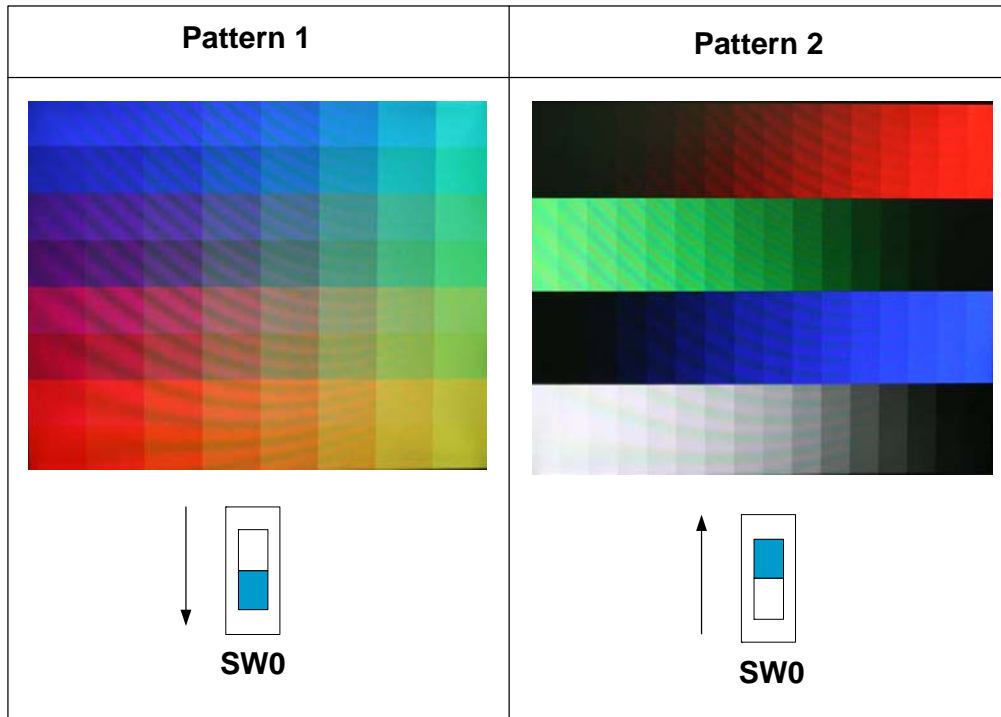

Figure 5-7. The output color pattern type for the demonstration