

SDI HSMC

Terasic SDI HSMC Board

User Manual

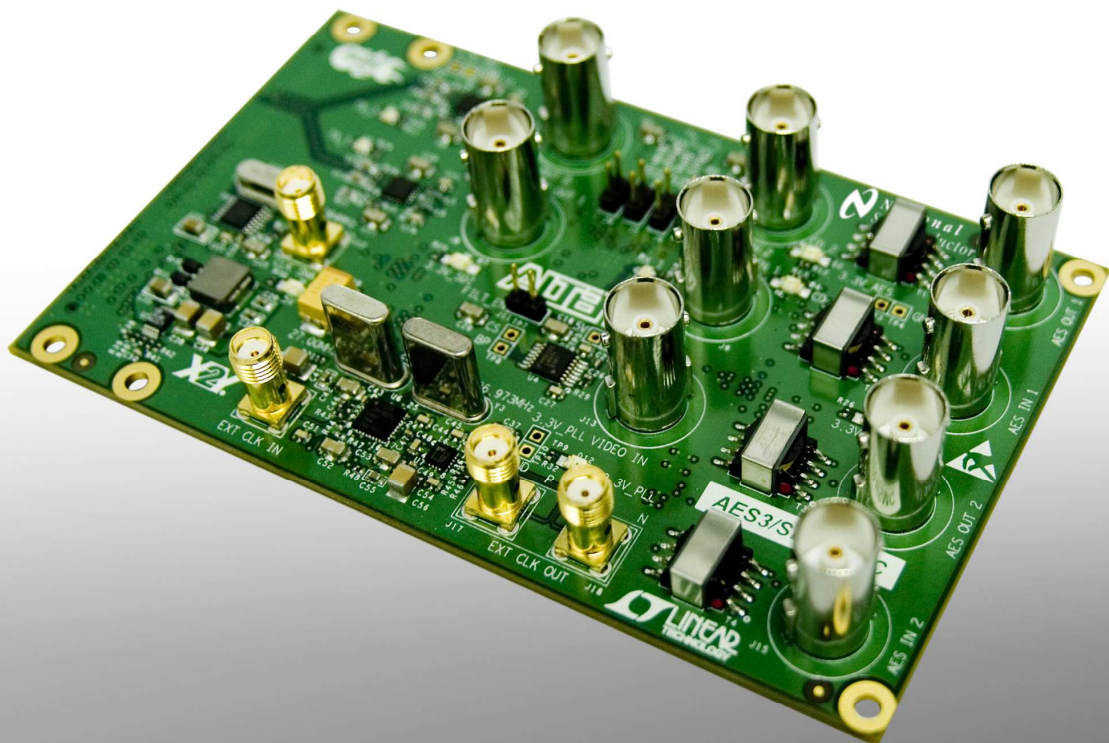

INTRODUCTION.....	1
1.1 1.1 FEATURES.....	1
1.2 1.2 ABOUT THE KIT	2
1.3 1.3 ASSEMBLE THE SDI HSMC BOARD	3
1.4 1.4 GETTING HELP	4
ARCHITECTURE.....	5
2.1 2.1 LAYOUT AND COMPONENTS.....	5
2.2 2.2 BLOCK DIAGRAM	7
BOARD COMPONENTS.....	8
3.1 3.1 THE SDI HSMC CONNECTOR	8
3.2 3.2 AUDIO/VIDEO INPUT AND OUTPUT	16
3.3 3.3 CLOCK CIRCUITRY.....	21
3.4 3.4 GENERAL USER INPUT/OUTPUT	24
3.5 3.5 POWER SUPPLY.....	25
DEMONSTRATION	26
4.1 4.1 INTRODUCTION	26
4.2 4.2 SYSTEM REQUIREMENTS	26
4.3 4.3 SETUP THE DEMONSTRATION	27
4.4 4.4 DEMO OPERATION.....	27
4.5 4.5 OVERVIEW	28
APPENDIX.....	30
5.1 5.1 REVISION HISTORY.....	30
5.2 5.2 ALWAYS VISIT SDI HSMC WEBPAGE FOR NEW MAIN BOARD.....	30

The SDI HSMC Board is a transceiver serial digital interface HSMC board that provides a hardware platform for developing video broadcasting systems. It is intended to be used by customers to implement and design SDI and AES systems based on transceiver-based host boards with HSMC interface. Furthermore, the SDI HSMC board is designed for professional video equipment developers with SDI interface that allows FPGA design to access to industry standard video transport signals.

1.1 Features

Figure 1.1 shows the photo of the SDI HSMC board. The important features are listed below:

- SDI
 - ✓ Two SDI transmit (TX) channels with SDI cable tri-speed drivers
 - ✓ Two SDI receive (RX) channels with SDI cable equalizers
 - ✓ Two 75-Ω BNC SDI TX interfaces
 - ✓ Two 75-Ω BNC SDI RX interfaces
 - ✓ Adjustable 1.1 V to 1.8 V and Standard 3.3 V CMOS Input Signal Levels
- AES3
 - ✓ Two RS422 transceivers for AES3 TX and AES3 RX channels
 - ✓ Two 75-Ω BNC AES3 RX interfaces
 - ✓ Two 75-Ω BNC AES3 TX interfaces
- Power
 - ✓ High frequency switching regulator for 12-V to 5-V power conversion
 - ✓ Three linear regulators for 5-V to 3.3-V low noise power conversion
 - ✓ FDTIM analysis for power distribution network (PDN) decoupling
- Clocks
 - ✓ One SDI multi-frequency VCXO femto clock video PLL
 - ✓ 98.304 MHz/90.3168 MHz/122.88 MHz/112.896 MHz voltage-controlled crystal oscillator (VCXO) based phase-locked loop (PLL)
 - ✓ One LVPECL differential clock buffer with two differential outputs – HSMC and SMA
- Four digital audio isolation transformers
- One multi-format video sync separator
- One HSMC connector for interface conversion, which is fully compatible with HSMC host boards

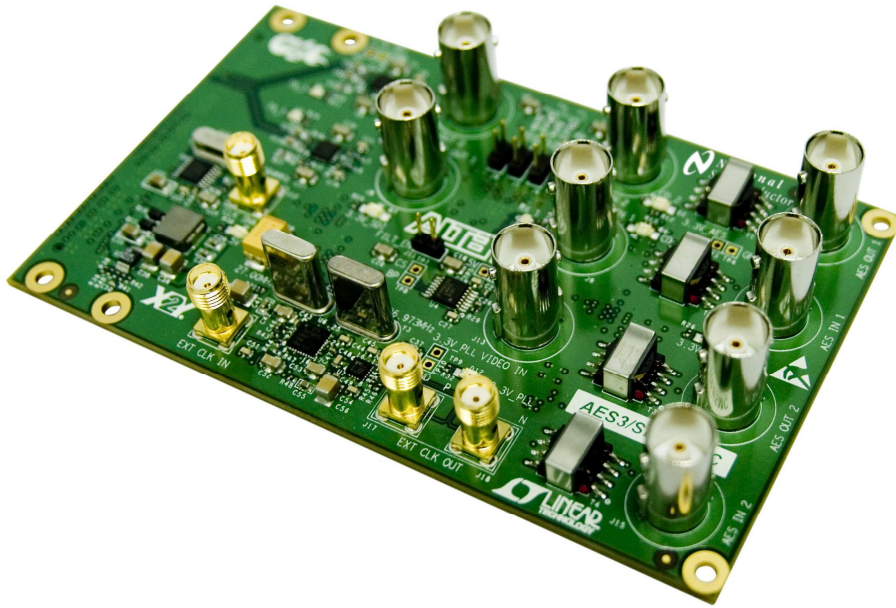

Figure 1.1. The SDI HSMC Board

1.2 About the KIT

This section describes the package content

- SDI HSMC Board x 1
- System CD-ROM x 1

The CD contains technical documents of the SDI HSMC, and one reference design along with the source code.

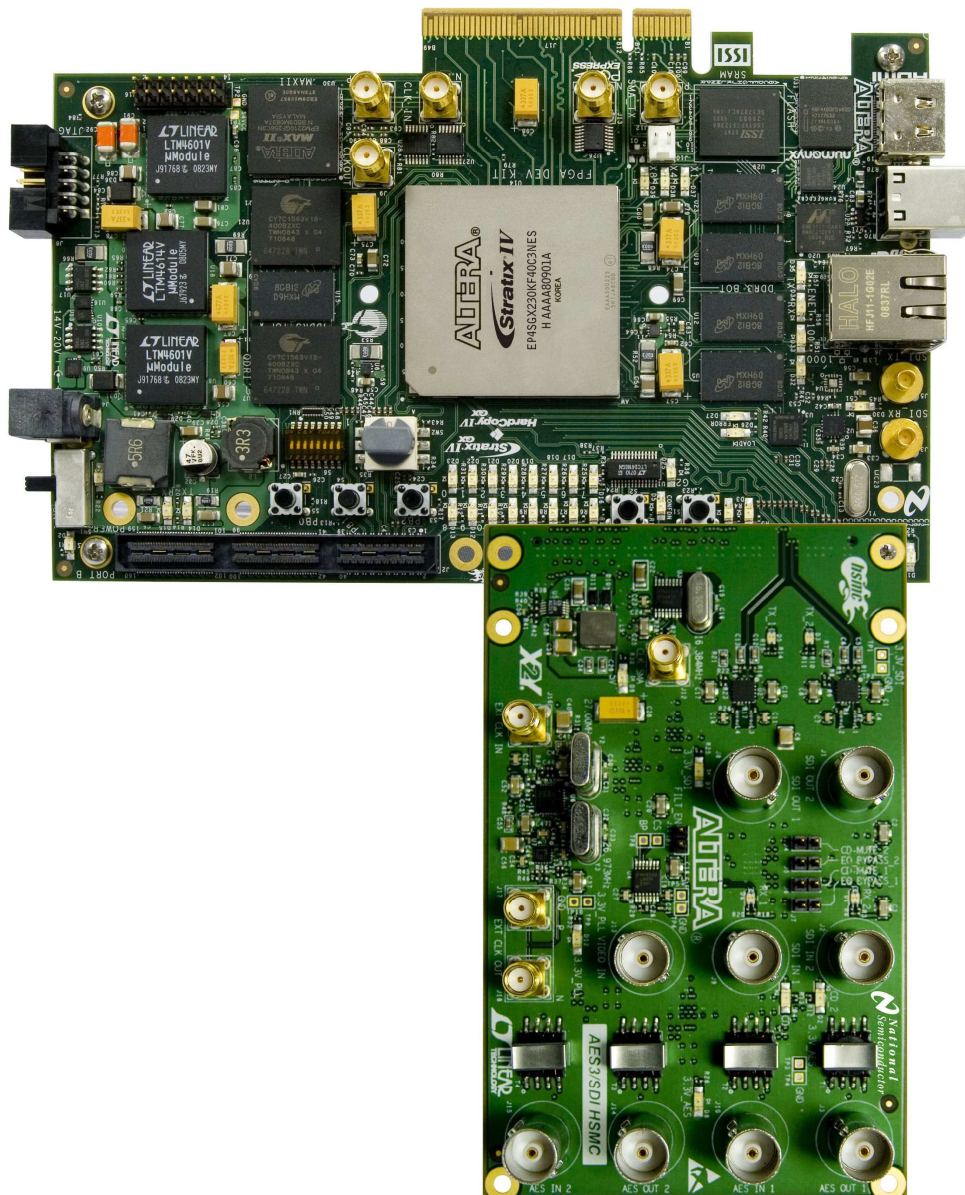

Figure 1.2 SDI HSMC Package

1.3 Assemble the SDI HSMC Board

This section describes how to connect the SDI HSMC board to a main board, and using the Stratix IV GX FPGA Development Board as an example.

The SDI HSMC board connects to the Stratix IV GX FPGA Development Board.



Note. Do not attempt to connect/remove the SDI HSMC daughter board to/from the main board when the power is on, or else the hardware could be damaged.

1.4 Getting Help

Here are some places to get help if you encounter any problem:

- ✓ Email to support@terasic.com
- ✓ Taiwan & China: +886-3-550-8800
- ✓ Korea : +82-2-512-7661
- ✓ Japan: +81-428-77-7000

This chapter covers the architecture of the SDI HSMC board including its PCB and block diagram.

2.1 Layout and Components

The picture of the SDI HSMC board is shown in Figure 2.1 and Figure 2.2. It depicts the layout of the board and indicates the location of the connectors and key components.

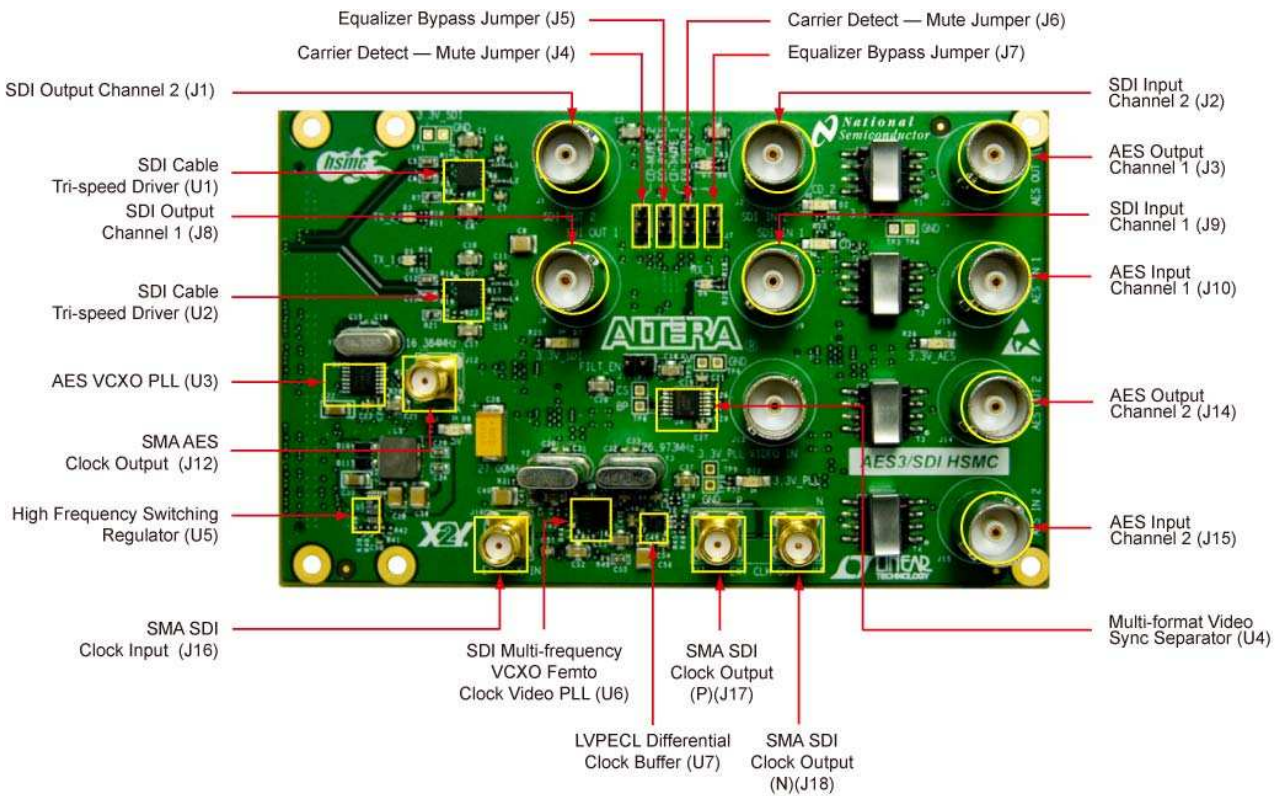

Figure 2.1. The SDI HSMC PCB and component diagram

Architecture

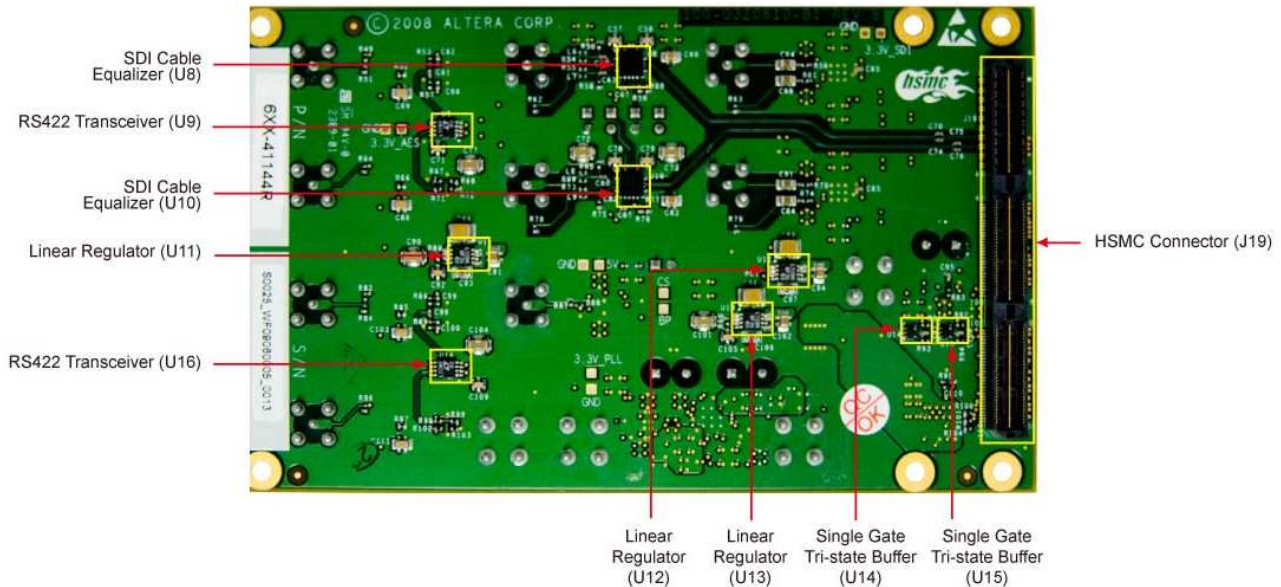

Figure 2.2. The SDI HSMC back side – HSMC connector view

The following components are provided on the SDI HSMC board :

- SDI Output Channel 2 (J1), SDI Input Channel 2 (J2), AES Output Channel 1 (J3), Equalizer Bypass Jumper (J5), Carrier Detect – Mute Jumper (J6), Equalizer Bypass Jumper (J7), SDI Output Channel 1 (J8), SDI Input Channel 1 (J9), AES Input Channel 1 (J10), SMA AES Clock Output (J12), AES Output Channel 2 (J14), AES Input Channel 2 (J15), SMA SDI Clock Input (J16), SMA SDI Clock Output (N) (J18)
- SDI Cable Tri-speed Driver (U1), SDI Cable Tri-speed Driver (U2), AES VCXO PLL (U3), Mutli-format Video Sync Separator (U4), High Frequency Switching Regulator (U5), SDI Multi-frequency VCXO Femto Clock Video PLL (U6), LVPECL Differential Clock Buffer (U7), SDI Cable Equalizer (U8), RS422 Transceiver (U9), SDI Cable Equalizer (U10), Linear Regulator (U11), Linear Regulator (U12), Linear Regulator (U13), Single Gate Tri-state Buffer (U14), Single Gate Tri-state Buffer (U15), RS422 Transceiver (U16), HSMC Connector (J19)

2.2 Block Diagram

Figure 2.3 shows the block diagram of the SDI HSMC board

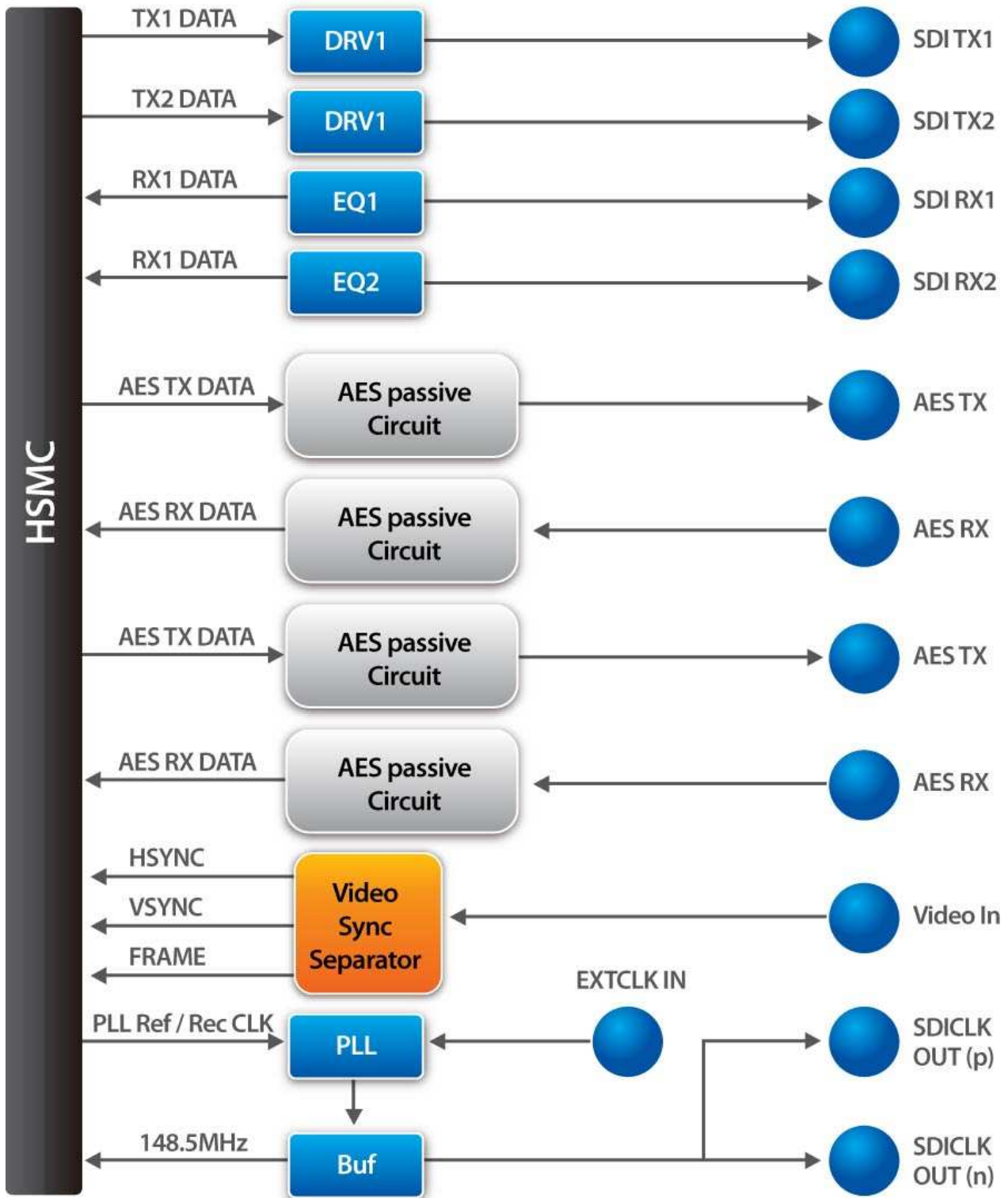

Figure 2.3. The block diagram of the SDI HSMC board

This section illustrates the detailed information of the components, connector interfaces, and the pin mapping tables of the SDI HSMC board.

3.1 The SDI HSMC Connector

This section describes pin definition of the SDI HSMC interface onboard

All the control and data signals of the SDI and AES are connected to the HSMC connector, so users can fully control the SDI HSMC board through the HSMC interface. Power is derived from 3.3V and 12V of the HSMC connector.

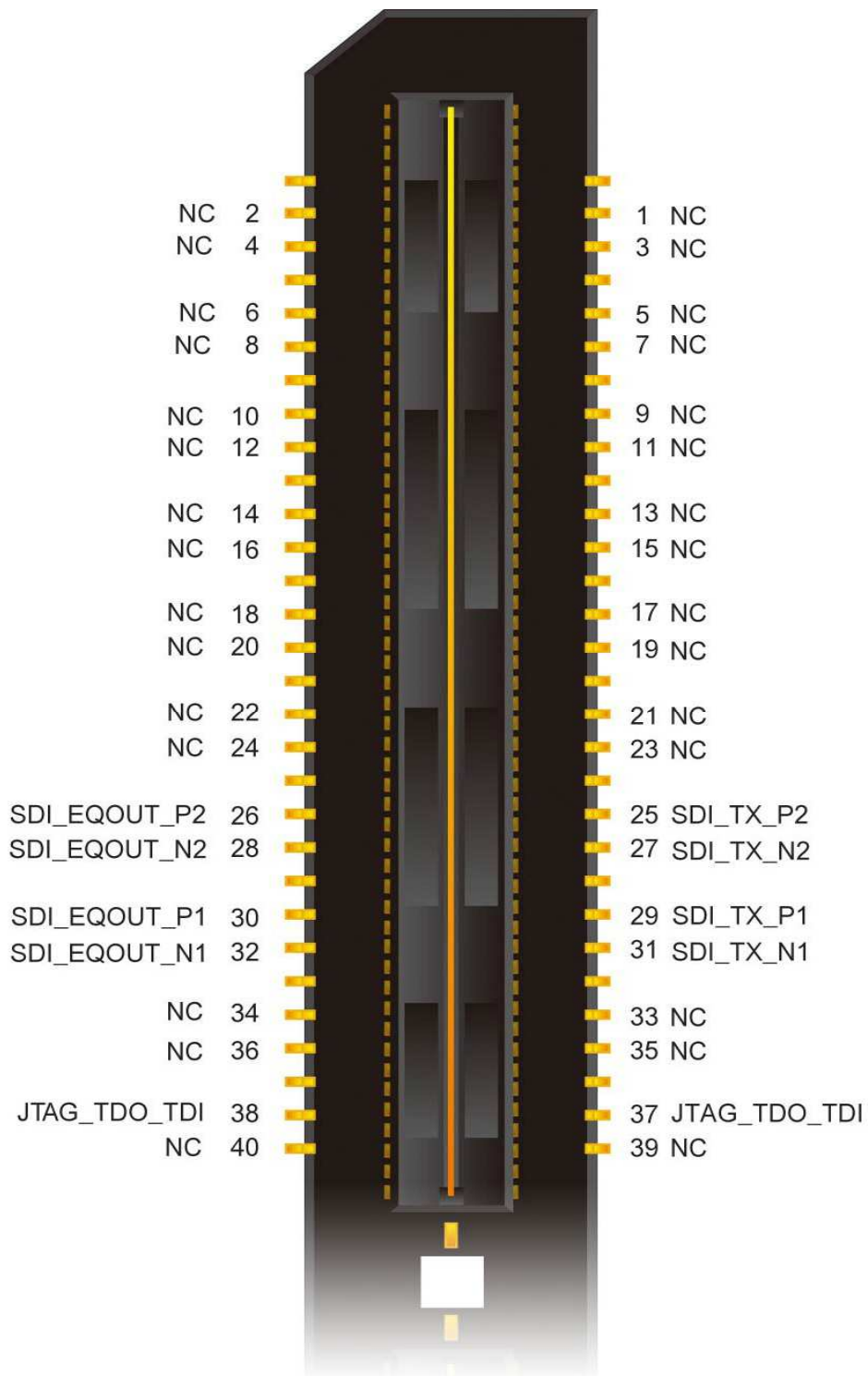

Figure 3.1. The pin-outs of Bank 1 on the HSMC connector

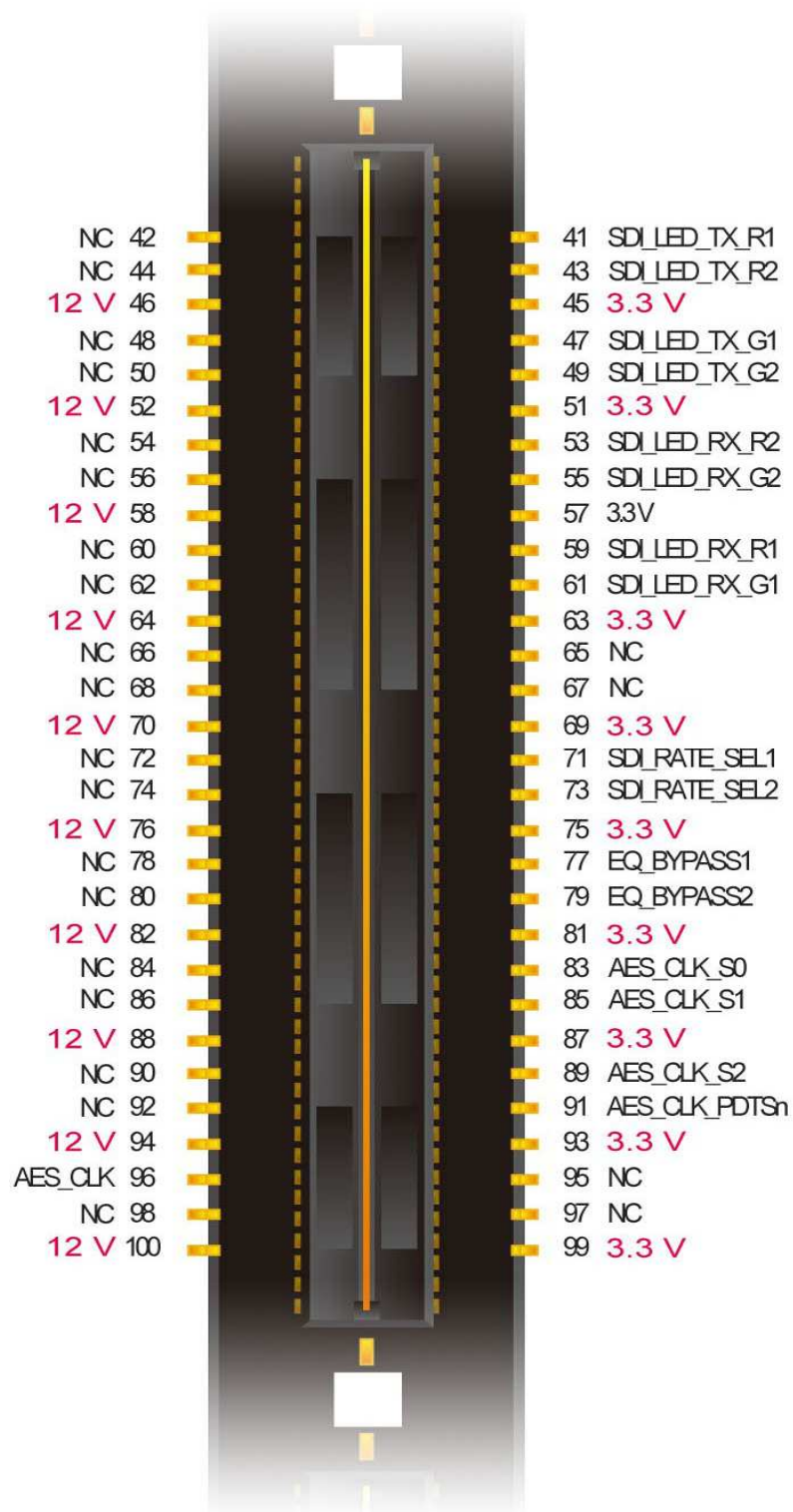

Figure 3.2. The pin-outs of Bank 2 of the HSMC connector.

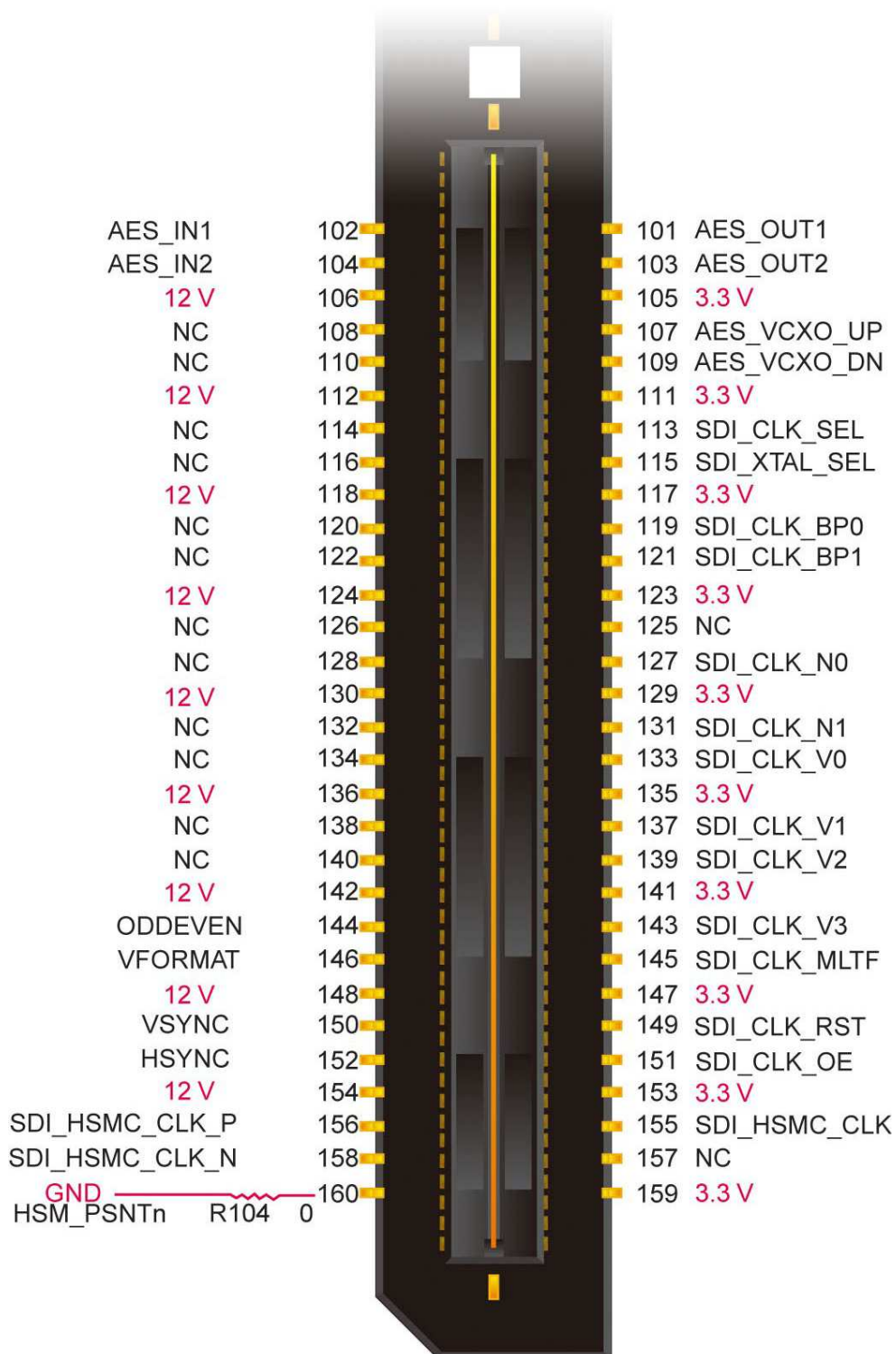

Figure 3.3. The pin-outs of Bank 3 of the HSMC connector

Board Components

The table 3.1 below lists the HSMC signal direction and description.

Table 3.1

Pin Numbers	Name	Direction	Description
1	N.C.	N/A	Not Connect
2	N.C.	N/A	Not Connect
3	N.C.	N/A	Not Connect
4	N.C.	N/A	Not Connect
5	N.C.	N/A	Not Connect
6	N.C.	N/A	Not Connect
7	N.C.	N/A	Not Connect
8	N.C.	N/A	Not Connect
9	N.C.	N/A	Not Connect
10	N.C.	N/A	Not Connect
11	N.C.	N/A	Not Connect
12	N.C.	N/A	Not Connect
13	N.C.	N/A	Not Connect
14	N.C.	N/A	Not Connect
15	N.C.	N/A	Not Connect
16	N.C.	N/A	Not Connect
17	N.C.	N/A	Not Connect
18	N.C.	N/A	Not Connect
19	N.C.	N/A	Not Connect
20	N.C.	N/A	Not Connect
21	N.C.	N/A	Not Connect
22	N.C.	N/A	Not Connect
23	N.C.	N/A	Not Connect
24	N.C.	N/A	Not Connect
25	SDI_TX_P2	Input	Differential transmitted data
26	SDI_EQOUT_P2	Output	Differential received data
27	SDI_TX_N2	Input	Differential transmitted data
28	SDI_EQOUT_N2	Output	Differential received data
29	SDI_TX_P1	Input	Differential transmitted data
30	SDI_EQOUT_P1	N/A	Differential received data
31	SDI_TX_N1	Input	Differential transmitted data
32	SDI_EQOUT_N1	Output	Differential received data
33	N.C.	N/A	Not Connect

Board Components

34	N.C.	N/A	Not Connect
35	N.C.	N/A	Not Connect
36	N.C.	N/A	Not Connect
37	JTAG_TDO_TDI	Inout	JTAG data loop through
38	JTAG_TDO_TDI	Inout	JTAG data loop through
39	N.C.	N/A	Not Connect
40	N.C.	N/A	Not Connect
41	SDI_LED_TX_R1	Input	Red LED signal transmit channel 1
42	N.C.	N/A	Not Connect
43	SDI_LED_TX_R2	Input	Red LED signal transmit channel 2
44	N.C.	N/A	Not Connect
45	3V3	Power	Power 3.3V
46	12V	Power	Power 12V
47	SDI_LED_TX_G1	Input	Green LED signal transmit channel 1
48	N.C.	N/A	Not Connect
49	SDI_LED_TX_G2	Input	Green LED signal transmit channel 2
50	N.C.	N/A	Not Connect
51	3V3	Power	Power 3.3V
52	12V	Power	Power 12V
53	SDI_LED_RX_R2	Output	Red LED signal receive channel 2
54	N.C.	N/A	Not Connect
55	SDI_LED_RX_G2	Output	Green LED signal receive channel 2
56	N.C.	N/A	Not Connect
57	3V3	Power	Power 3.3V
58	12V	Power	Power 12V
59	SDI_LED_RX_R1	Output	Red LED signal receive channel 1
60	N.C.	N/A	Not Connect
61	SDI_LED_RX_G1	Output	Green LED signal receive channel 1
62	N.C.	N/A	Not Connect
63	3V3	Power	Power 3.3V
64	12V	Power	Power 12V
65	N.C.	N/A	Not Connect
66	N.C.	N/A	Not Connect
67	N.C.	N/A	Not Connect
68	N.C.	N/A	Not Connect
69	3V3	Power	Power 3.3V
70	12V	Power	Power 12V
71	SDI_RATE_SEL1	Input	Cable driver's slew rate for desired bit rate

Board Components

72	N.C.	N/A	Not Connect
73	SDI_RATE_SEL2	Input	Cable driver's slew rate for desired bit rate
74	N.C.	N/A	Not Connect
75	3V3	Power	Power 3.3V
76	12V	Power	Power 12V
77	EQ_BYPASS1	Input	Equalizer bypass receive channel 1
78	N.C.	N/A	Not Connect
79	EQ_BYPASS2	Input	Equalizer bypass receive channel 2
80	N.C.	N/A	Not Connect
81	3V3	Power	Power 3.3V
82	12V	Power	Power 12V
83	AES_CLK_S0	Input	AES frequency select
84	N.C.	N/A	Not Connect
85	AES_CLK_S1	Input	AES frequency select
86	N.C.	N/A	Not Connect
87	3V3	Power	Power 3.3V
88	12V	Power	Power 12V
89	AES_CLK_S2	Input	AES frequency select
90	N.C.	N/A	Not Connect
91	AES_CLK_PDTSn	Input	AES clock power down and tri-state
92	N.C.	N/A	Not Connect
93	3V3	Power	Power 3.3V
94	12V	Power	Power 12V
95	N.C.	N/A	Not Connect
96	AES_CLK	Output	AES clock reference
97	N.C.	N/A	Not Connect
98	N.C.	N/A	Not Connect
99	3V3	Power	Power 3.3V
100	12V	Power	Power 12V
101	AES_OUT1	Input	AES data output 1
102	AES_IN1	Input	AES data input 1
103	AES_OUT2	Input	AES data output 2
104	AES_IN2	Input	AES data input 2
105	3V3	Power	Power 3.3V
106	12V	Power	Power 12V
107	AES_VCXO_UP	Input	AES VCXO frequency control
108	N.C.	N/A	Not Connect
109	AES_VCXO_DN	Input	AES VCXO frequency control

Board Components

110	N.C.	N/A	Not Connect
111	3V3	Power	Power 3.3V
112	12V	Power	Power 12V
113	SDI_CLK_SEL	Input	SDI clock input select
114	N.C.	N/A	Not Connect
115	SDI_XTAL_SEL	Input	SDI clock crystal select
116	N.C.	N/A	Not Connect
117	3V3	Power	Power 3.3V
118	12V	Power	Power 12V
119	SDI_CLK_BP0	Input	SDI clock control
120	N.C.	N/A	Not Connect
121	SDI_CLK_BP1	Input	SDI clock control
122	N.C.	N/A	Not Connect
123	3V3	Power	Power 3.3V
124	12V	Power	Power 12V
125	N.C.	N/A	Not Connect
126	N.C.	N/A	Not Connect
127	SDI_CLK_N0	Input	SDI clock control
128	N.C.	N/A	Not Connect
129	3V3	Power	Power 3.3V
130	12V	Power	Power 12V
131	SDI_CLK_N1	Input	SDI clock control
132	N.C.	N/A	Not Connect
133	SDI_CLK_V0	Input	SDI clock control
134	N.C.	N/A	Not Connect
135	3V3	Power	Power 3.3V
136	12V	Power	Power 12V
137	SDI_CLK_V1	Input	SDI clock control
138	N.C.	N/A	Not Connect
139	SDI_CLK_V2	Input	SDI clock control
140	N.C.	N/A	Not Connect
141	3V3	Power	Power 3.3V
142	12V	Power	Power 12V
143	SDI_CLK_V3	Input	SDI clock control
144	ODDEVEN	Output	Video sync output of odd/even field
145	SDI_CLK_MLTF	Input	SDI clock control
146	VFORMAT	Output	Video sync output
147	3V3	Power	Power 3.3V

Board Components			
148	12V	Power	Power 12V
149	SDI_CLK_RST	Input	SDI clock control
150	VSYNC	Output	Vertical sync output
151	SDI_CLK_OE	Input	SDI clock output enable
152	HSYNC	Output	Horizontal sync output
153	3V3	Power	Power 3.3V
154	12V	Power	Power 12V
155	SDI_HSMC_CLK	Input	SDI chip reference clock input
156	SDI_HSMC_CLK_P	Output	SDI clock hot reference clock
157	N.C.	N/A	Not Connect
158	SDI_HSMC_CLK_N	N/A	SDI clock hot reference clock
159	3V3	Power	Power 3.3V
160	GND	Power	Power Ground

3.2 Audio/Video Input and Output

This section describes the I/O channels of the SDI HSMC.

SDI RX Channels

The SDI RX channel consists of an SDI cable equalizer (LMH0344) with bypass, an input matching network, an input vertical mount with a 4-GHz BNC connector, a bypass control signal, DC blocking caps on the input and output, and a carrier detect LED.

The RX channel receives 270 Mbps, 1.485 Gbps, and 2.970 Gbps SDI signals through a single-ended 75-Ω BNC connector. The signals traverse an impedance-matching network provided by the manufacturer. The input signal is terminated to ground with a 75-Ω external resistor and is input into the SDI cable equalizer via a 1- μF DC blocking capacitor. The opposite leg of the SDI cable equalizer's differential input pin is terminated in the same way as the input signal and serves to correctly balance the input bias currents internal to the equalizer. The equalizer then equalizes the signal and outputs a 100-Ω differential signal to the SERDES receiver located on the host HSMC device. The differential output of the SDI cable equalizer passes through 1- μF DC blocking capacitors.

Figure 3.4 shows the SDI RX channel block diagram

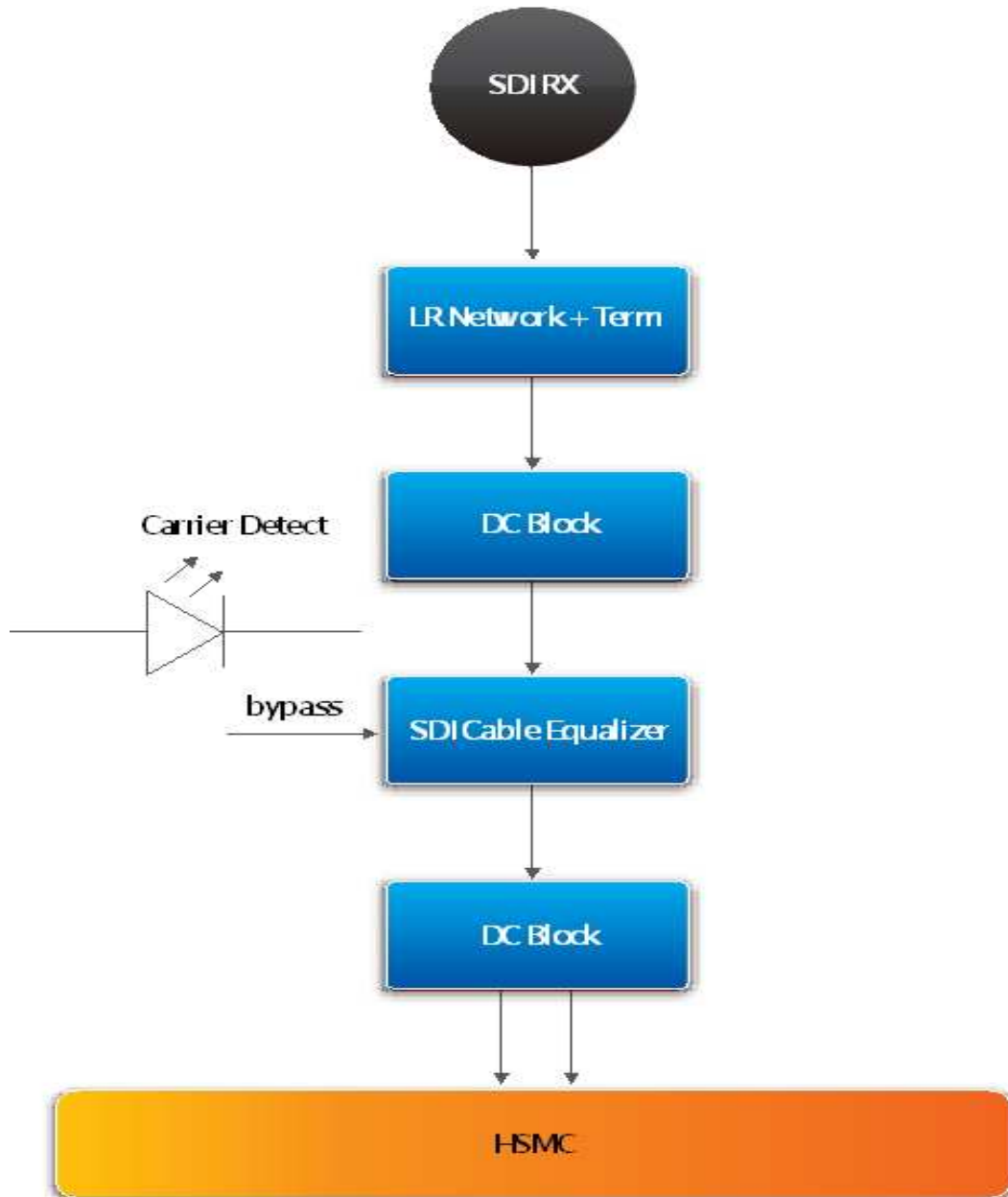

SDI TX Channels

The SDI TX channel consists of a SDI cable tri-speed driver (LMH0302) with slew rate control, an output impedance matching network, an output vertical mount with a 4-GHz BNC connector, an SDI rate select control signal, DC blocking caps on the input and output, and a red/green LED.

The SDI TX channel transmits at 270 Mbps, 1.485 Gbps and 2.970 Gbps rates using a 75-Ω coaxial cable. The SDI signals traverses an impedance matching network provided by the manufacturer and then goes through a DC blocking capacitor before being sent to the BNC connector. The output signal is back-terminated to 3.3 V externally with 75-Ω resistors. The output DC blocking capacitors consist of 4.7- μF

Board Components

capacitors. The opposite leg of the SDI cable driver's differential output pin is terminated in the same way as the output signal and serves to correctly balance the output currents internal to the device.

The output of the TX pins of the HSMC host boards should not be installed with DC blocking capacitors. If DC blocking capacitors are installed, remove the capacitors and install 0- Ω resistors of the same foot print size (0402). The input of the SDI cable driver is differentially terminated with a 100- Ω resistor and has 4.7- μ F DC blocking capacitors.

Figure 3.5 shows the SDI TX Channel block diagram

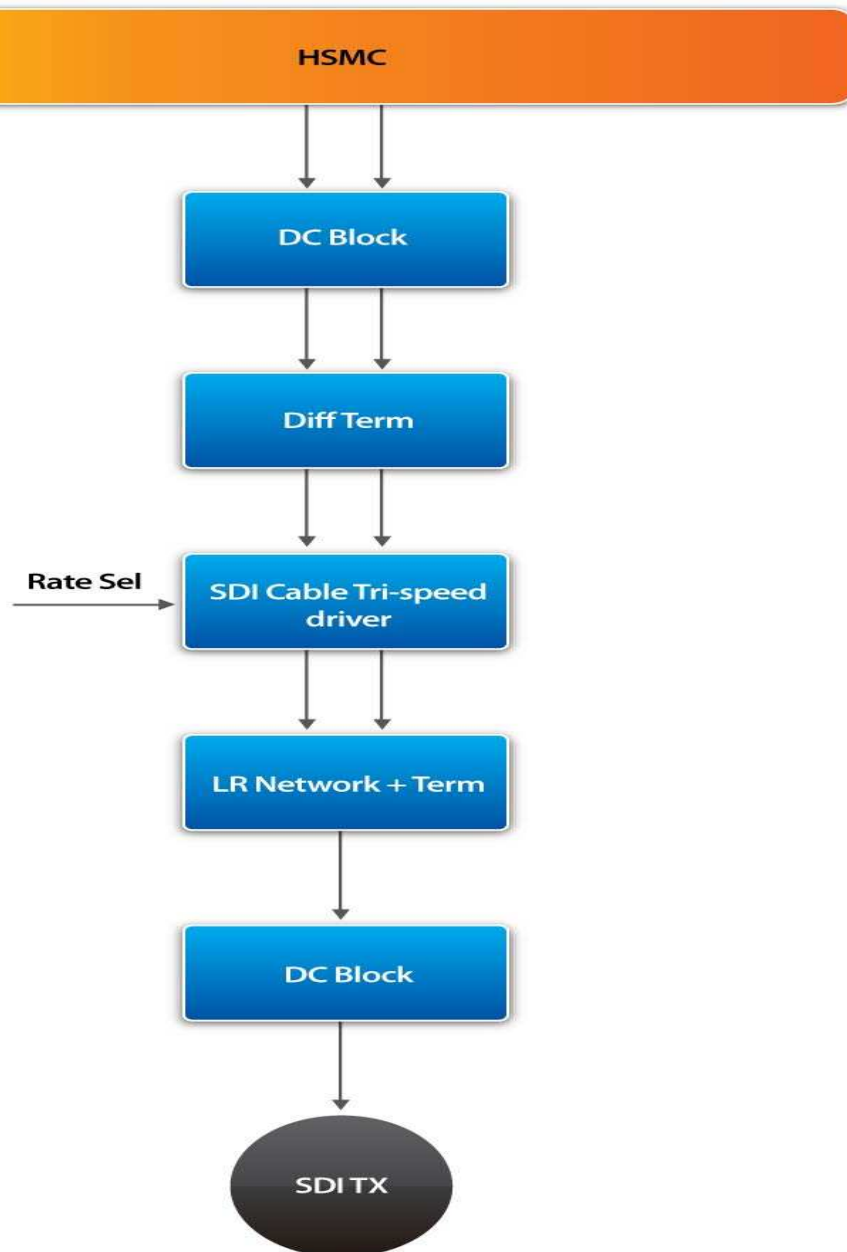

AES3 RX Channels

The AES3 RX channel delivers a 75-Ω load termination with a return loss of 25 dB or more. The signal is input through a 75-Ω BNC and terminated with a 75-Ω resistor to ground. The unbalanced signal is then balanced through an isolation transformer. The differential signal output from the transformer is biased and input to a RS422 transceiver. The output of the RS422 transceiver is a single-ended LVCMOS signal which is driven to the host board through the HSMC connector.

Figure 3.6 shows the AES3 RX Channel block diagram

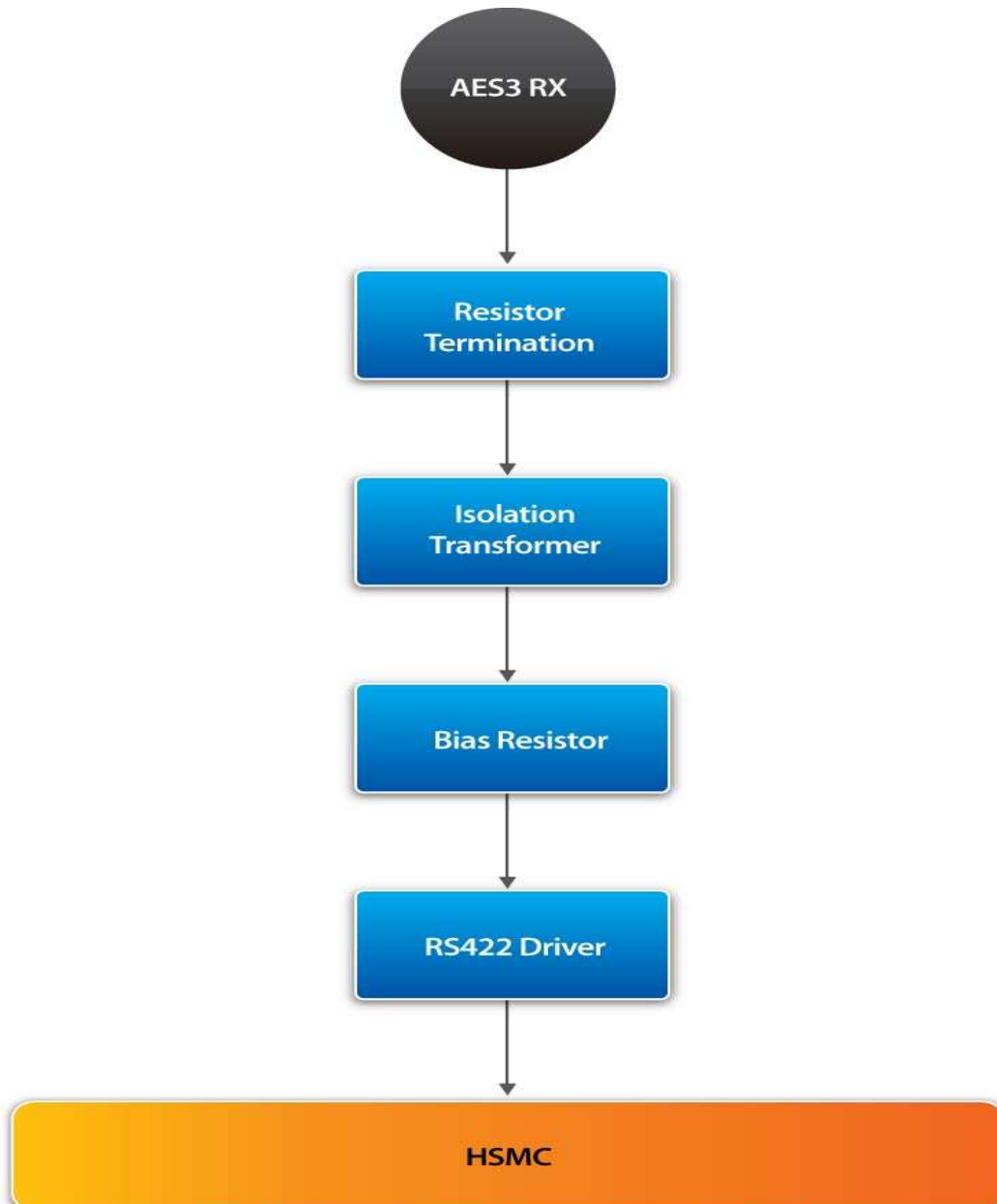

AES3 TX Channels

The AES3 TX channel is designed to have a balanced signal driver to the isolation transformer. The output of the RS422 transceiver has an RX network to limit the output slew rate, thus limiting the bandwidth of AES3 output. The AE3 channel is designed to support 192-kHz to 24-kHz sample rates. The output is unbalanced with a source impedance of 75 Ω and a return loss of 25 dB or more. The peak-to-peak output voltage is 1.0V centered around the ground of the transmitter.

Figure 3.7 shows the AES3 TX Channel block diagram

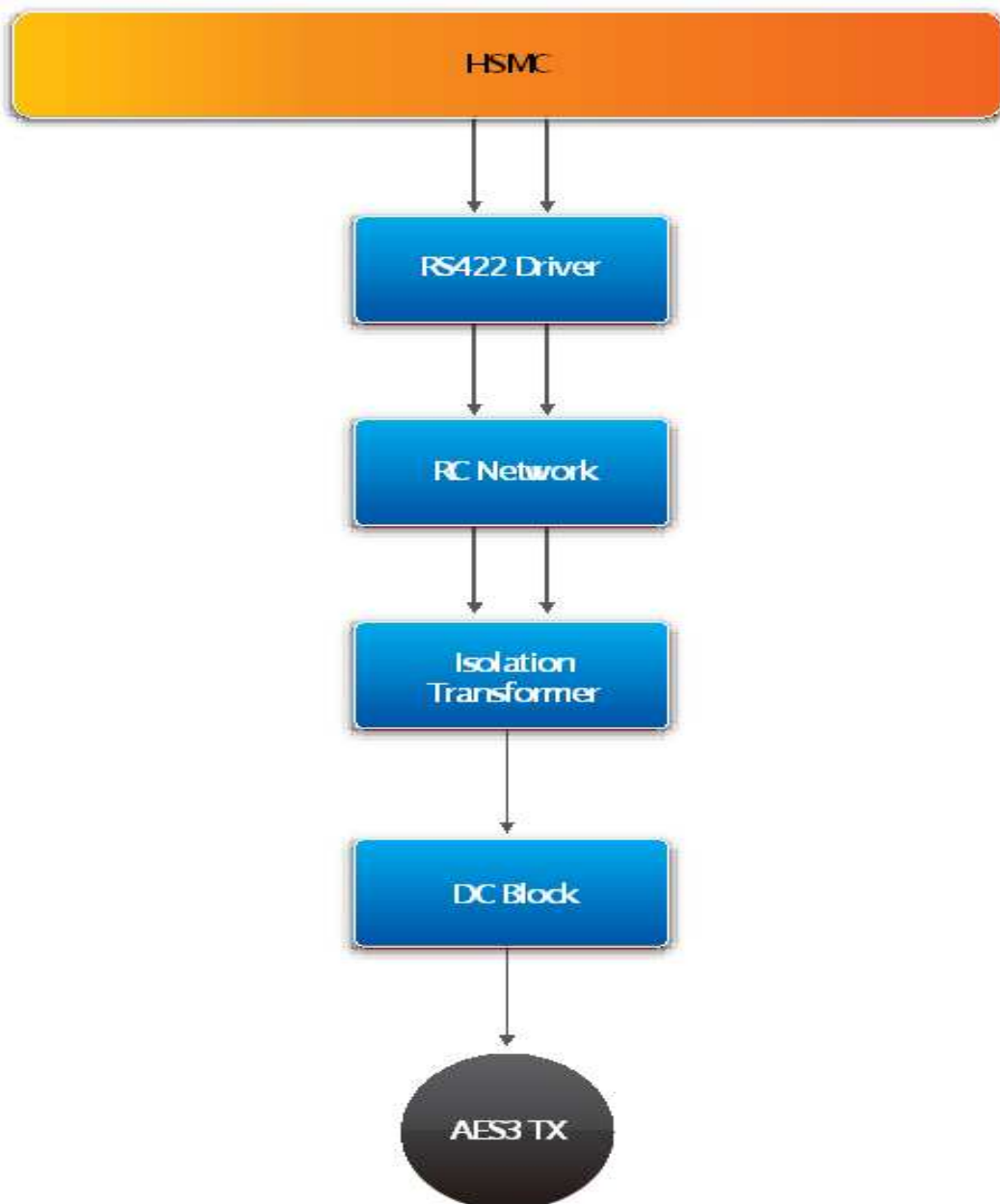

3.3 Clock Circuitry

This section describes the board's clock inputs and outputs.

SDI Clock

The reference clocks can be generated from the host board, external video sources, and external SDI sources. The output of the clock generator should produce frequency of 148.5 MHz or 148.5 MHz/1.001 (148.35 MHz) from the SMA outputs or the HSMC connector.

Figure 3.8 shows the SDI HSMC clocking diagram.

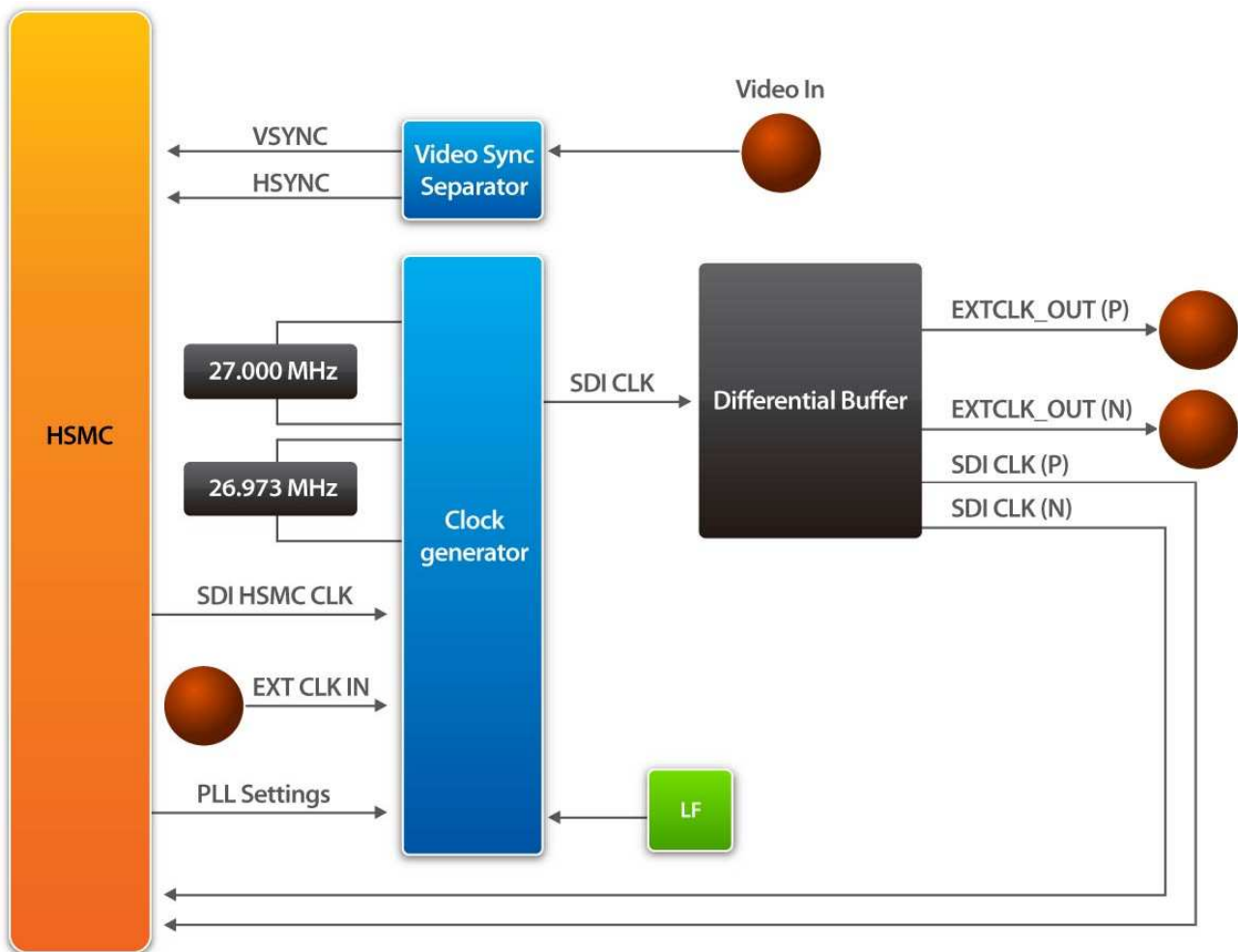

Figure 3.8 SDI HSMC Clocking diagram

The SDI multi-frequency VCXO femto clock video PLL (ICS810001-21) is utilized for the SDI reference clocks. The board inputs two crystals, 27 MHz and 26.973027 MHz to the clock generator which allow low-jitter operation for US and European SDI standard rates. The HSMC signal SDI_XTAL_SEL determines which crystal is locked by the internal VCXO. Clock inputs to the SDI PLL can come from either the HSMC host or through an SMA input where both inputs are end-terminated at 50 Ω to ground. The HSMC signal SDI_CLK_SEL determines which input is active.

The output of the clock generator is single-ended. A differential LVPECL clock buffer is used to convert the reference clock to differential signal and drive the signal to the host device to prevent common mode noise that might be present in the signaling path from the clock generator to the HSMC host device.

Host Board Reference Clock

You can select one of the several reference clock frequencies to input as a reference to the DI multi-frequency VCXO femto clock video PLL. For example, if the host board has a 100-MHz oscillator, you can divide the frequency by 6,400 to 15.625 kHz and drive that frequency to the clock generator to be multiplied to 148.5 MHz. We recommend locking the VCXO PLL to a stable oscillator which is located on the host board when the daughtercard is sourcing data or when the VCXO PLL is not locked onto a received signal or reference. This locking prevents wandering or frequency hunting.

Loop Back Reference Clock From SDI Input

When an RX channel is locked onto the input data stream, the recovered clock represents the actual bit rate of the stream. This recovered clock is often 74.25 MHz and can be buffered from the host board and driven out through the HSMC interface to the clock generator on the SDI HSMC. The clock output from the host is cleaned (jitter), multiplied to 148.5 MHz, and driven back to the host board to be used as the SERDES reference clock. Using this technique maintains the flow through timing.

Studio Reference Timing

If a studio clock source (a 27-MHz source) is available, the source can be connected to the EXT CLK IN SMA port on the daughtercard.

Studio Reference Video Timing

A video synchronizing separator is provided to synchronize the SDI video output streams to analog video. The horizontal and vertical syncs are driven to the host board and can be driven back to the video clock generator chip to produce a 148.5-MHz SERDES reference.

AES3 Clock

AES3 clocking uses clock device from IDT (ICS275-22) that comes with pre-programmed to produce 93.304 MHz, 90.3168 MHz (4x oversampling), 122.88 MHz, and 112.896 MHz (5x oversampling) from a 16.384-MHz crystal. Output CLK1 and CLK2 are connected to the HSMC and SMA connector respectively. Output CLK1 is connected to the MSHC connector and drives a signal to the host device. Output CLK2 can be used

for a reference, to trigger test equipment or to sync a signal to other devices in the AES3 system.

The base part (ICS275) is a VCXO that can have various combinations of input, output, and feedback dividers to produce variations of the crystal frequency. The control voltage input of the device is controlled by a passive network of resistors and capacitors that are connected to tri-state buffers, one driven high and the other driven low when in the active state (non-tri-stated). The single gate devices are powered by 3.3 V to allow full swing of the control voltage (Vin, AES_CLK_V) because the ICS275 is also powered by 3.3 V. The tri-state-enabled pins are controlled by the host device connected to the HSMC. These pins should not be allowed to float.

To use the ICS275 as a normally oscillator and not as a VCXO, drive signals AES_VCXO_UP and AES_VCXO_DN both to logic 1. Both output signals are enabled and the resulting voltage output after the resistor or capacitor network is a mid-voltage driven to the Vin of the ICS275 device.

To use the ICS275 as a VCXO in a PLL application, connect the phase detector to the AES3 up and down control signals.

Table 3.2 the audio rate and clock frequencies supported by the SDI HSMC

Audio Sample Rate (kHz)	Bit Rate Clock (MHz)	Oversampling Rate	VCXO Frequency
24.00	3.0720	32	98.3040
32.00	4.090	24	98.3040
44.10	5.6448	16	90.3168
48.00	6.1440	16	98.3040
88.20	11.2896	8	90.3168
96.00	12.2880	8	98.3040
176.4	22.5792	4	90.3168
192	24.5760	4	98.3040
24.00	3.0720	40	122.8800
32.00	4.0960	30	122.8800
44.10	5.6448	20	112.8960
48.00	6.1440	20	122.8800
88.20	11.2896	10	112.8960
96.00	12.2880	10	122.880
176.4	22.5792	5	112.8960
192	24.5760	5	122.8800

Table defines the frequency output with respect to the three 1-bit control signals, S [2:0]. Outputs from CLK3 and CLK4 are not used in the VCXO PLL. The frequencies programmed into the VCXO PLL support 4x and 5x over-sampling of the most popular audio sample rates.

Table 3.3 VCXO PLL Frequency Output

S2	S1	S0	CLK1 (MHz)	CLK2 (MHz)	CLK3	CLK4
0	0	0	98.304	98.304	OFF	OFF
0	0	1	90.3168	90.3168	OFF	OFF
0	1	0	122.88	122.88	OFF	OFF
0	1	1	112.896	112.896	OFF	OFF
1	0	0	98.304	122.88	OFF	OFF
1	0	1	90.3168	112.896	OFF	OFF
1	1	0	98.304	90.3168	OFF	OFF
1	1	1	122.88	112.896	OFF	OFF

3.4 General User Input/Output

This section describes the user I/O interface to the board

The SDI HSMC board has jumper switches CD_MUTE channels 1 and 2 and EQ_BYPASS channels 1 and 2. By default, the jumpers are installed on the CD_MUTE jumper switches (J4 and J6), while the EQ_BYPASS jumper switches (J5 and J7) are not installed. Jumpers J5 (EQ_BYPASS2) and J7 (EQ_BYPASS1) can be controlled from the host device.

Table 3.4 lists the jumper descriptions and schematic signal names

Board Reference	Schematic Signal Name	Description	I/O Standard
J4	CD_MUTE2	Carrier detect jumper switch which connects to RX channel 2 (CD_MUTE2) on U8. This jumper is normally installed.	Signal short
J5	EQ_BYPASS2	Equalizer bypass for RX channel 2. The equalizer can be by passed manually when EQ_BYPASS2 signal is tri-stated. This jumper is normally not installed and the switch is controlled by asserting the EQ_BYPASS2 signal. A high signal bypasses the SDI receiver equalizer.	CMOS
J6	CD_MUTE1	Carrier detect jumper switch which connects to RX channel 1 (CD_MUTE1) on U10. This jumper is normally installed.	Signal short
J7	EQ_BYPASS1	Equalizer bypass for RX channel 1. The equalizer can be bypassed manually when EQ_BYPASS1 signal is tri-stated this jumper is normally not installed and the switch is controlled by asserting the EQ_BYPASS1 signal. A high signal bypasses the SDI receiver equalizer.	CMOS

3.5 Power Supply

This section describes the power supply on the SDI HSMC board

The power distribution on the SDI HSMC board is shown in Figure 3.9

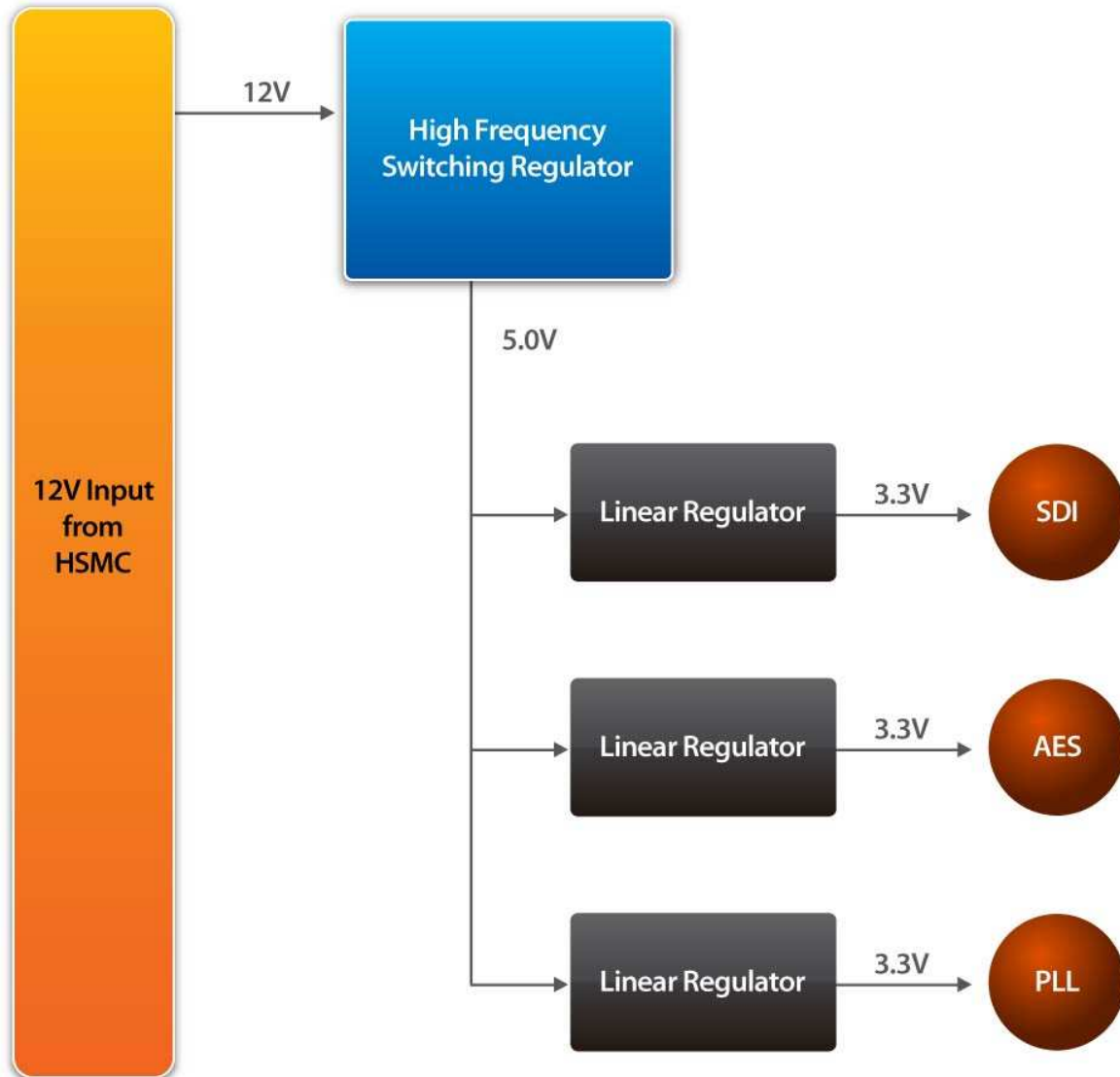

Figure 3.9 Power distribution on the SDI HSMC board

This Chapter illustrates the reference design for the SDI HSMC board

4.1 Introduction

This section describes the functionality of the demonstration briefly.

The demonstration shows how to use the Stratix IV GX FPGA Development Board to test the functionality of the SDI video and AES audio transmit and receive pairs. The tests are PRBS data pattern loopback tests using the two AES digital audio ports and the two SDI digital video ports on the SDI HSMC. AES audio channel tests run at 24 Mbps and SDI tests run at 2.97 Gbps.

4.2 System Requirements

The following items are required for the SDI HSMC demonstration.

- HSMC SDI Board x 1
- Stratix IV GX FPGA Development Board x 1
- 75-Ω BNC to BNC Cables x 4
- Jumpers for CD_MUTE x 2

4.3 Setup the Demonstration

Figure 4.3 shows how to setup hardware for the SDI HSMC demonstration.



Note: The SDI HSMC board must be connected to HSMC Slot “A” of the Stratix IV GX FPGA Development Board for this demonstration.

Figure 4.3

4.4 Demo Operation

This section describes the procedures of running the demonstration

FPGA Configuration

Demonstration Setup, File Locations, and Instructions

SDI HSMC Demo:

- Project directory: S4PCIe_HSMCAESSDI_test
- Bit Stream used: S4PCIe_HSMCAESSDI_test.sof

Demonstration

- Connect the AES/SDI HSMC board to the Stratix IV GX FPGA Development Board to HSMC Slot “A”
- Connect the 75-Ω BNC cables from:
 - J1 (SDI OUT 2) to J2 (SDI IN 2)
 - J8 (SDI OUT 1) to J9 (SDI IN 1)
 - J14 (AES OUT 2) to J2 (AES IN 2)
 - J3 (AES OUT 1) to J10 (AES IN 1)
- Install Jumpers for J4 (CD_MUTE 2) and J6 (CD_MUTE 1)
- Set the rotary switch (SW2) to the 1 position.
- Power on the Stratix IV GX FPGA Development Board and download with SOF file (S4PCIe_HSMCAESSDI_test.sof)
- Press reset button located on the host board to initiate the test

4.5 Overview

This section describes the design concepts for the SDI HSMC demonstration.

To monitor the results of each test, connect a BNC loopback cable between the corresponding, transmit and receive connectors. Tests run on all channels simultaneously, but only channels with loopback cables display accurate information.

When the Stratix IV GX FPGA Development Board is powered on, the LEDs (D1, D3, D5, D6) alternate between the states of: OFF, RED, GREEN, ORANGE.

Connection Test:

The connection test verifies the connections made on the SDI and AES channels.

By pressing pushbutton PB0 on the host board it will check if everything is connected correctly and data is being transmitted and received correctly. The USER LEDs 1, 2, 4, 5 on the host board correspond to links SDI port 1, SDI port2, AES port 1 and AES port2 respectively which will illuminate if the connection are connected correctly.

If LEDs 1, 2, 4, 5 do not illuminate then there is connectivity issue with that link, otherwise if they all illuminate then the receivers are receiving the correct data.

Error Insertion Test:

The error insertion test inserts a bit error into the transmit data stream each time you press the following push button:

By pressing pushbutton PB1 which forces an error links on SDI and AES1 that causes LEDs 2 and 5 to go out respectively.

By pressing pushbutton PB2 which forces an error links on SD2 and AES2 that causes LEDs 1 and 4 to go out respectively.

By pressing PB0, LEDS 1, 2, 4, 5 will turn back on.

Self-debugging Test:

Perform the following test to debug connectivity issues with the SDI transmitters to SDI receivers, and AES transmitters to AES receivers.

By disconnecting BNC from SDI OUT 1 (J8), LED 2 will go out.

By disconnecting BNC from SDI OUT 2 (J1), LED 1 will go out.

By disconnecting BNC from AES OUT 1 (J3), LED 5 will go out.

By disconnecting BNC from AES OUT 2 (J14), LED 4 will go out.

You may cross connect the SDI transmitters to the SDI receivers, as well as the AES transmitters to the AES receivers. If during a cross connection a channel fails, then the failure is in the transmitter of that channel that was failing.