

## Fast Turn-off Thyristor Type P0128SH10# to P0128SH12#

### Absolute Maximum Ratings

	VOLTAGE RATINGS	MAXIMUM LIMITS	UNITS
$V_{DRM}$	Repetitive peak off-state voltage, (note 1)	1000-1200	V
$V_{DSM}$	Non-repetitive peak off-state voltage, (note 1)	1000-1200	V
$V_{RRM}$	Repetitive peak reverse voltage, (note 1)	1000-1200	V
$V_{RSM}$	Non-repetitive peak reverse voltage, (note 1)	1100-1300	V

	OTHER RATINGS	MAXIMUM LIMITS	UNITS
$I_{T(AVM)}$	Maximum average on-state current, $T_{case}=55^{\circ}C$ , (note 2)	128	A
$I_{T(AVM)}$	Maximum average on-state current. $T_{case}=85^{\circ}C$ , (note 2)	83	A
$I_{T(RMS)}$	Nominal RMS on-state current, $T_{case}=25^{\circ}C$ , (note 2)	260	A
$I_{T(d.c.)}$	D.C. on-state current, $T_{case}=25^{\circ}C$	206	A
$I_{TSM}$	Peak non-repetitive surge $t_p=10ms$ , $V_{rm}=0.6V_{RRM}$ , (note 3)	1700	A
$I_{TSM2}$	Peak non-repetitive surge $t_p=10ms$ , $V_{rm}\leq 10V$ , (note 3)	1950	A
$I^2t$	$I^2t$ capacity for fusing $t_p=10ms$ , $V_{rm}=0.6V_{RRM}$ , (note 3)	19000	$A^2s$
$I^2t$	$I^2t$ capacity for fusing $t_p=10ms$ , $V_{rm}\leq 10V$ , (note 3)	13700	$A^2s$
$(di/dt)_{cr}$	Critical rate of rise of on-state current (repetitive), (Note 4)	500	$A/\mu s$
	Critical rate of rise of on-state current (non-repetitive), (Note 4)	1000	$A/\mu s$
$V_{RGM}$	Peak reverse gate voltage	5	V
$P_{G(AV)}$	Mean forward gate power	1.5	W
$P_{GM}$	Peak forward gate power	30	W
$T_{j op}$	Operating temperature range	-40 to +125	$^{\circ}C$
$T_{stg}$	Storage temperature range	-40 to +150	$^{\circ}C$

### Notes:-

- 1) De-rating factor of 0.13% per  $^{\circ}C$  is applicable for  $T_j$  below  $25^{\circ}C$ .
- 2) Single phase; 50Hz,  $180^{\circ}$  half-sinewave.
- 3) Half-sinewave,  $125^{\circ}C$   $T_j$  initial.
- 4)  $V_D=67\% V_{DRM}$ ,  $I_{FG}=2A$ ,  $t_r\leq 0.5\mu s$ ,  $T_{case}=125^{\circ}C$ .

**Characteristics**

	PARAMETER	MIN.	TYP.	MAX.	TEST CONDITIONS (Note 1)	UNITS
V <sub>TM</sub>	Maximum peak on-state voltage	-	-	2.30	I <sub>TM</sub> =280A	V
V <sub>TM</sub>	Maximum peak on-state voltage	-	-	2.60	I <sub>TM</sub> =384A	V
V <sub>T0</sub>	Threshold voltage	-	-	1.60		V
r <sub>T</sub>	Slope resistance	-	-	2.49		mΩ
(dv/dt) <sub>cr</sub>	Critical rate of rise of off-state voltage	200	-	-	V <sub>D</sub> =80% V <sub>DRM</sub> , Linear ramp, Gate o/c	V/μs
I <sub>DRM</sub>	Peak off-state current	-	-	20	Rated V <sub>DRM</sub>	mA
I <sub>RDM</sub>	Peak reverse current	-	-	20	Rated V <sub>RRM</sub>	mA
V <sub>GT</sub>	Gate trigger voltage	-	-	3.0	T <sub>J</sub> =25°C V <sub>D</sub> =10V, I <sub>T</sub> =3A	V
I <sub>GT</sub>	Gate trigger current	-	-	200		mA
V <sub>GD</sub>	Gate non-trigger voltage	-	-	0.25		Rated V <sub>DRM</sub>
I <sub>H</sub>	Holding current	-	-	600	T <sub>J</sub> =25°C	mA
t <sub>gd</sub>	Gate controlled turn-on delay time	-	0.4	1.0	V <sub>D</sub> =67% V <sub>DRM</sub> , I <sub>TM</sub> =500A, di/dt=10A/μs, I <sub>FG</sub> =2A, t <sub>r</sub> =0.5μs, T <sub>J</sub> =25°C	μs
t <sub>gt</sub>	Turn-on time	-	0.8	2.0		
Q <sub>rr</sub>	Recovered charge	-	50	-	I <sub>TM</sub> =100A, t <sub>p</sub> =500μs, di/dt=10A/μs, V <sub>r</sub> =50V	μC
Q <sub>ra</sub>	Recovered charge, 50% Chord	-	25	45		μC
I <sub>rm</sub>	Reverse recovery current	-	15	-		A
t <sub>rr</sub>	Reverse recovery time	-	3.0	-		μs
t <sub>q</sub>	Turn-off time (note 2)	10	-	15	I <sub>TM</sub> =100A, t <sub>p</sub> =500μs, di/dt=10A/μs, V <sub>r</sub> =50V, V <sub>dr</sub> =80% V <sub>DRM</sub> , dV <sub>dr</sub> /dt=20V/μs	μs
		20	-	25	I <sub>TM</sub> =100A, t <sub>p</sub> =500μs, di/dt=10A/μs, V <sub>r</sub> =50V, V <sub>dr</sub> =80% V <sub>DRM</sub> , dV <sub>dr</sub> /dt=200V/μs	
R <sub>thJ-C</sub>	Thermal resistance, junction to case	-	-	0.23	DC	K/W
R <sub>thJ-K</sub>	Thermal resistance, case to heatsink	-	-	0.08	DC	K/W
F	Mounting torque	11.5	-	14.5		Nm
W <sub>t</sub>	Weight	-	130	-		g

Notes:-

- 1) Unless otherwise indicated T<sub>J</sub>=125°C.
- 2) The required t<sub>q</sub> (specified with dV<sub>dr</sub>/dt=200V/μs) is represented by a '#' in the device part number. See ordering information for details of t<sub>q</sub> codes.

**Notes on Ratings and Characteristics**

1.0 Voltage Grade Table

Voltage Grade	$V_{DRM}$ $V_{DSM}$ $V_{RRM}$ V	$V_{RSM}$ V	$V_D$ $V_R$ DC V
10	1000	1100	700
12	1200	1300	810

2.0 Extension of Voltage Grades

This report is applicable to other and higher voltage grades when supply has been agreed by Sales/Production.

3.0 Extension of Turn-off Time

This Report is applicable to other  $t_q$ /re-applied  $dv/dt$  combinations when supply has been agreed by Sales/Production.

4.0 Repetitive  $dv/dt$

Higher  $dv/dt$  selections are available up to 1000V/ $\mu$ s on request.

5.0 De-rating Factor

A blocking voltage de-rating factor of 0.13%/ $^{\circ}$ C is applicable to this device for  $T_j$  below 25 $^{\circ}$ C.

6.0 Snubber Components

When selecting snubber components, care must be taken not to use excessively large values of snubber capacitor or excessively small values of snubber resistor. Such excessive component values may lead to device damage due to the large resultant values of snubber discharge current. If required, please consult the factory for assistance.

7.0 Rate of rise of on-state current

The maximum un-primed rate of rise of on-state current must not exceed 1500A/ $\mu$ s at any time during turn-on on a non-repetitive basis. For repetitive performance, the on-state rate of rise of current must not exceed 1000A/ $\mu$ s at any time during turn-on. Note that these values of rate of rise of current apply to the total device current including that from any local snubber network.

8.0 Gate Drive

The nominal requirement for a typical gate drive is illustrated below. An open circuit voltage of at least 30V is assumed. This gate drive must be applied when using the full  $di/dt$  capability of the device.

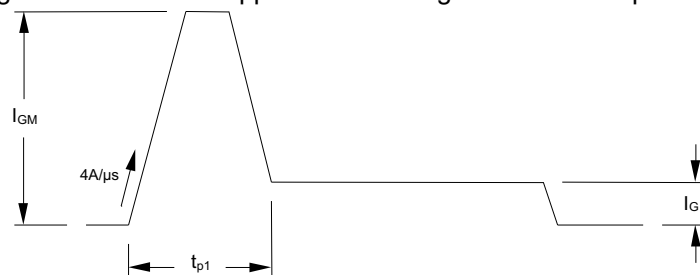

The magnitude of  $I_{GM}$  should be between five and ten times  $I_{GT}$ , which is shown on page 2. Its duration ( $t_{p1}$ ) should be 20 $\mu$ s or sufficient to allow the anode current to reach ten times  $I_L$ , whichever is greater. Otherwise, an increase in pulse current could be needed to supply the necessary charge to trigger. The 'back-porch' current  $I_G$  should remain flowing for the same duration as the anode current and have a magnitude in the order of 1.5 times  $I_{GT}$ .

9.0 Frequency Ratings

The curves illustrated in figures 11 to 16 are for guidance only and are superseded by the maximum ratings shown on page 1.

10.0 Square wave ratings

These ratings are given for load component rate of rise of forward current of 100 and 500 A/μs.

11.0 Duty cycle lines

The 100% duty cycle is represented on all the ratings by a straight line. Other duties can be included as parallel to the first.

12.0 Maximum Operating Frequency

The maximum operating frequency is set by the on-state duty, the time required for the thyristor to turn off ( $t_q$ ) and for the off-state voltage to reach full value ( $t_v$ ), i.e.

$$f_{max} = \frac{1}{t_{pulse} + t_q + t_v}$$

13.0 On-State Energy per Pulse Characteristics

These curves enable rapid estimation of device dissipation to be obtained for conditions not covered by the frequency ratings.

Let  $E_p$  be the Energy per pulse for a given current and pulse width, in joules  
 Let  $R_{th(J-Hs)}$  be the steady-state d.c. thermal resistance (junction to sink)  
 and  $T_{SINK}$  be the heat sink temperature.

Then the average dissipation will be:

$$W_{AV} = E_p \cdot f \text{ and } T_{SINK(max.)} = 125 - (W_{AV} \cdot R_{th(J-Hs)})$$

14.0 Reverse recovery ratings

(i)  $Q_{ra}$  is based on 50%  $I_{RM}$  chord as shown in Fig. 1

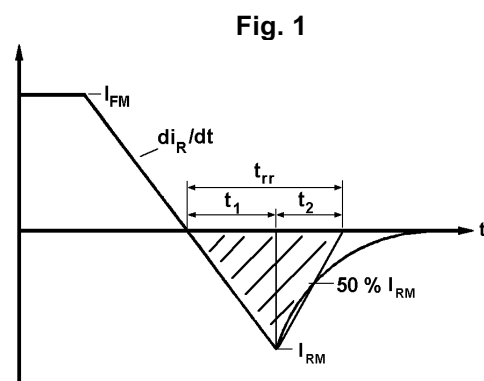

(ii)  $Q_{rr}$  is based on a 150μs integration time i.e.

$$Q_{rr} = \int_0^{150\mu s} i_{rr} \cdot dt$$

(iii)

$$K \text{ Factor} = \frac{t_1}{t_2}$$

## 15.0 Reverse Recovery Loss

### 15.1 Determination by Measurement

From waveforms of recovery current obtained from a high frequency shunt (see Note 1, Page 5) and reverse voltage present during recovery, an instantaneous reverse recovery loss waveform must be constructed. Let the area under this waveform be E joules per pulse. A new heat sink temperature can then be evaluated from the following:

$$T_{SINK(new)} = T_{SINK(original)} - E \cdot (k + f \cdot R_{th(J-Hs)})$$

Where  $k=0.227$  ( $^{\circ}\text{C}/\text{W}/\text{s}$ )

E = Area under reverse loss waveform per pulse in joules (W.s.)

f = rated frequency Hz at the original heat sink temperature.

$R_{th(J-Hs)}$  = d.c. thermal resistance ( $^{\circ}\text{C}/\text{W}$ ).

The total dissipation is now given by:

$$W_{(TOT)} = W_{(original)} + E \cdot f$$

### 15.2 Determination without Measurement

In circumstances where it is not possible to measure voltage and current conditions, or for design purposes, the additional losses E in joules may be estimated as follows.

Let E be the value of energy per reverse cycle in joules (curves in Figure 9).

Let f be the operating frequency in Hz

$$T_{SINK(new)} = T_{SINK(original)} - (E \cdot R_{th} \cdot f)$$

Where  $T_{SINK(new)}$  is the required maximum heat sink temperature and

$T_{SINK(original)}$  is the heat sink temperature given with the frequency ratings.

A suitable R-C snubber network is connected across the thyristor to restrict the transient reverse voltage to a peak value ( $V_{rm}$ ) of 67% of the maximum grade. If a different grade is being used or  $V_{rm}$  is other than 67% of Grade, the reverse loss may be approximated by a pro rata adjustment of the maximum value obtained from the curves.

### **NOTE 1- Reverse Recovery Loss by Measurement**

This thyristor has a low reverse recovered charge and peak reverse recovery current. When measuring the charge, care must be taken to ensure that:

- a.c. coupled devices such as current transformers are not affected by prior passage of high amplitude forward current.
- A suitable, polarised, clipping circuit must be connected to the input of the measuring oscilloscope to avoid overloading the internal amplifiers by the relatively high amplitude forward current signal
- Measurement of reverse recovery waveform should be carried out with an appropriate critically damped snubber, connected across diode anode to cathode. The formula used for the calculation of this snubber is shown below:

$$R^2 = 4 \cdot \frac{V_r}{C_s \cdot di/dt}$$

Where:  $V_r$  = Commutating source voltage  
 $C_s$  = Snubber capacitance  
 $R$  = Snubber resistance

**16.0 Computer Modelling Parameters**

**16.1 Calculating  $V_T$  using ABCD Coefficients**

The on-state characteristic  $I_T$  vs  $V_T$ , on page 7 is represented in two ways;

- (i) the well established  $V_0$  and  $r_s$  tangent used for rating purposes and
- (ii) a set of constants A, B, C, D, forming the coefficients of the representative equation for  $V_T$  in terms of  $I_T$  given below:

$$V_T = A + B \cdot \ln(I_T) + C \cdot I_T + D \cdot \sqrt{I_T}$$

The constants, derived by curve fitting software, are given in this report for hot and cold characteristics where possible. The resulting values for  $V_T$  agree with the true device characteristic over a current range, which is limited to that plotted.

25°C Coefficients		125°C Coefficients	
A	2.17025103	A	2.44502153
B	0.259583	B	-0.3427962
C	$2.93999 \times 10^{-3}$	C	$1.10355 \times 10^{-3}$
D	-0.0993591	D	0.08830165

**16.2 D.C. Thermal Impedance Calculation**

$$r_t = \sum_{p=1}^{p=n} r_p \cdot \left( 1 - e^{-\frac{t}{\tau_p}} \right)$$

Where  $p = 1$  to  $n$ ,  $n$  is the number of terms in the series.

- $t$  = Duration of heating pulse in seconds.
- $r_t$  = Thermal resistance at time  $t$ .
- $r_p$  = Amplitude of  $p^{\text{th}}$  term.
- $\tau_p$  = Time Constant of  $r_{\text{th}}$  term.

D.C. Single Side Cooled				
Term	1	2	3	4
$r_p$	0.04349271	0.09448932	0.08616715	0.01286952
$\tau_p$	3.338537	0.850259	0.09835131	$4.24 \times 10^{-3}$

**Curves**

Figure 1 - On-state characteristics of Limit device

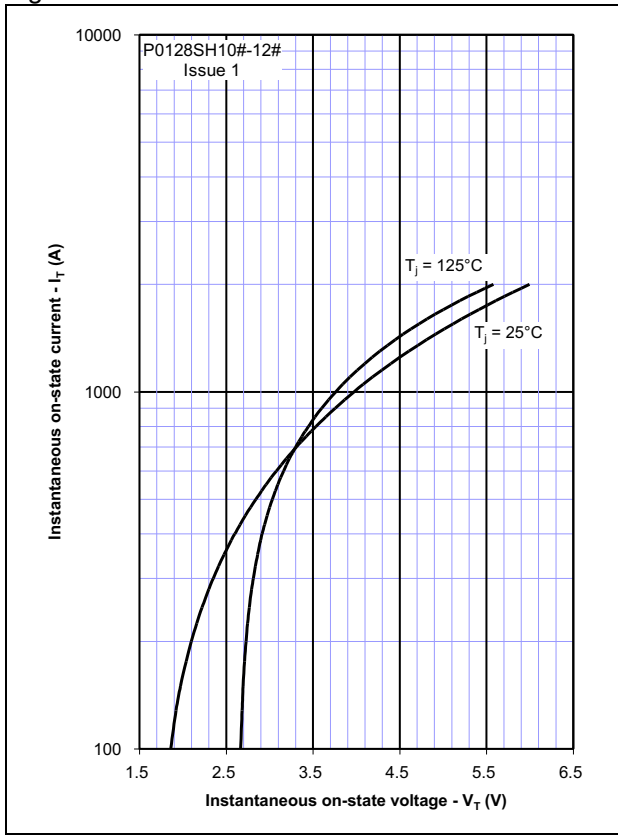

Figure 2 - Transient thermal impedance

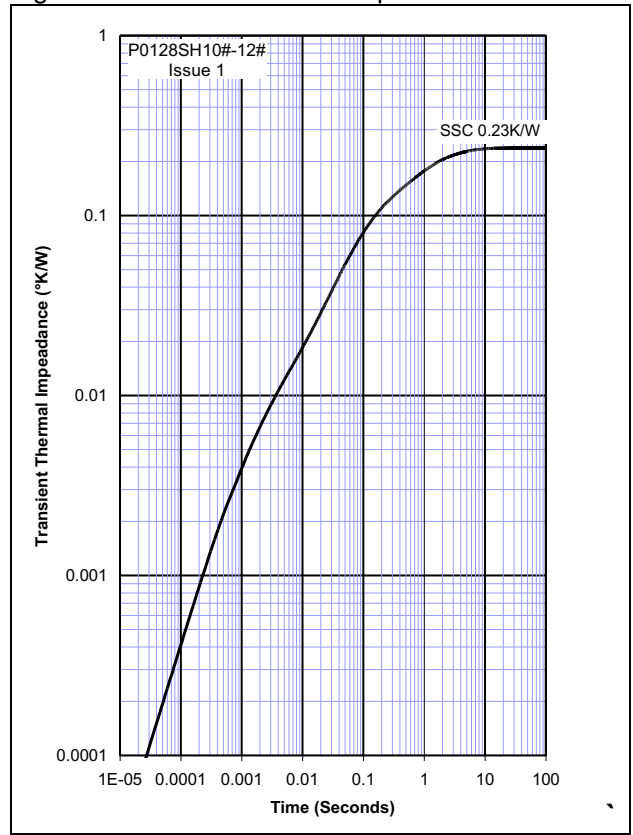

Figure 3 - Gate characteristics - Trigger limits

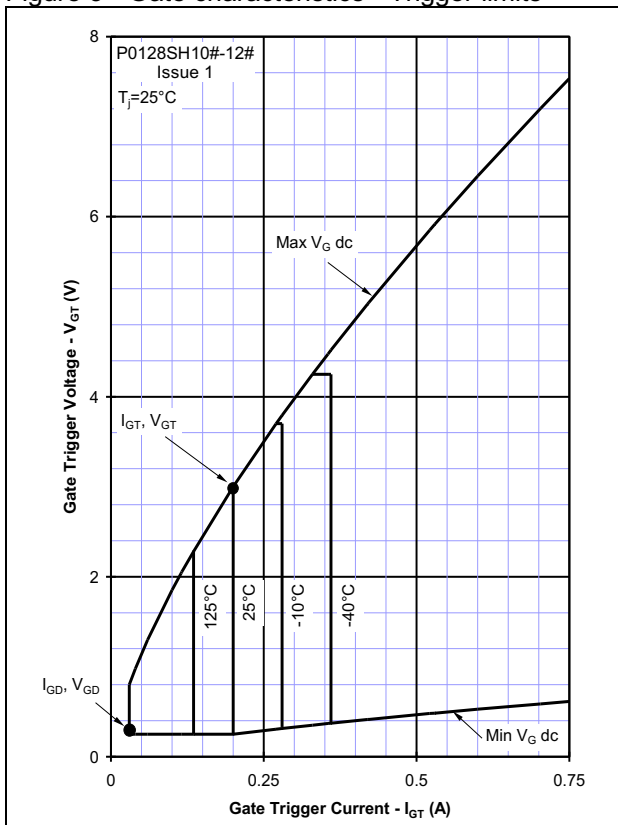

Figure 4 - Gate characteristics - Power curves

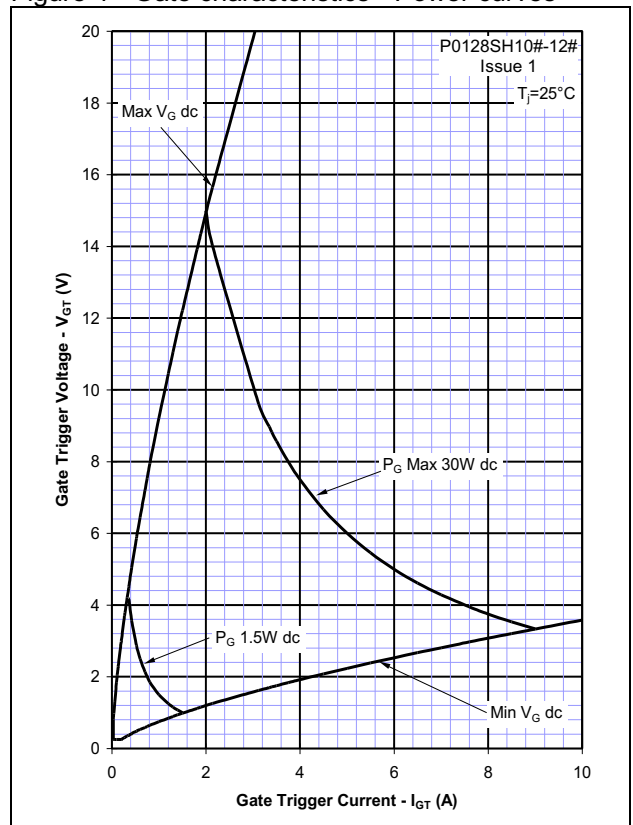

Figure 5 - Total recovered charge,  $Q_{rr}$

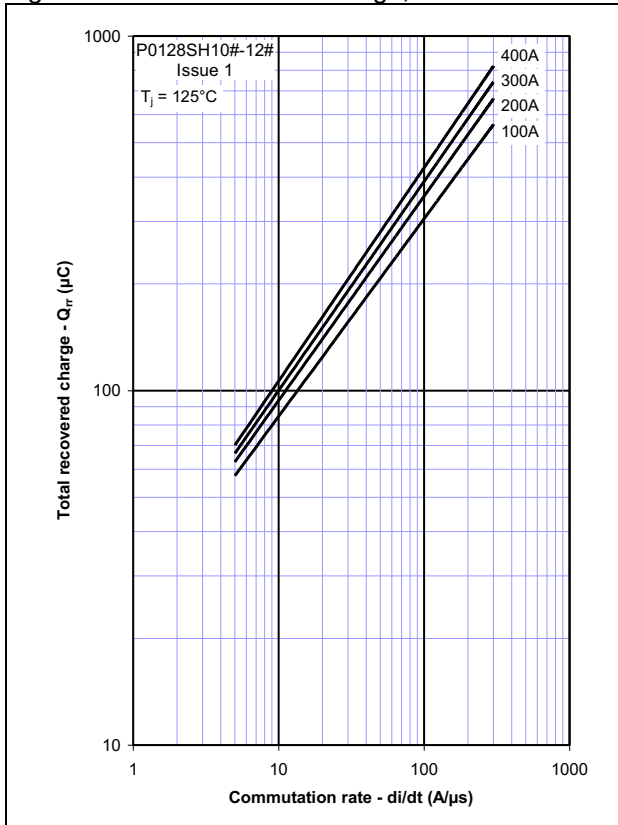

Figure 6 - Recovered charge,  $Q_{ra}$  (50% chord)

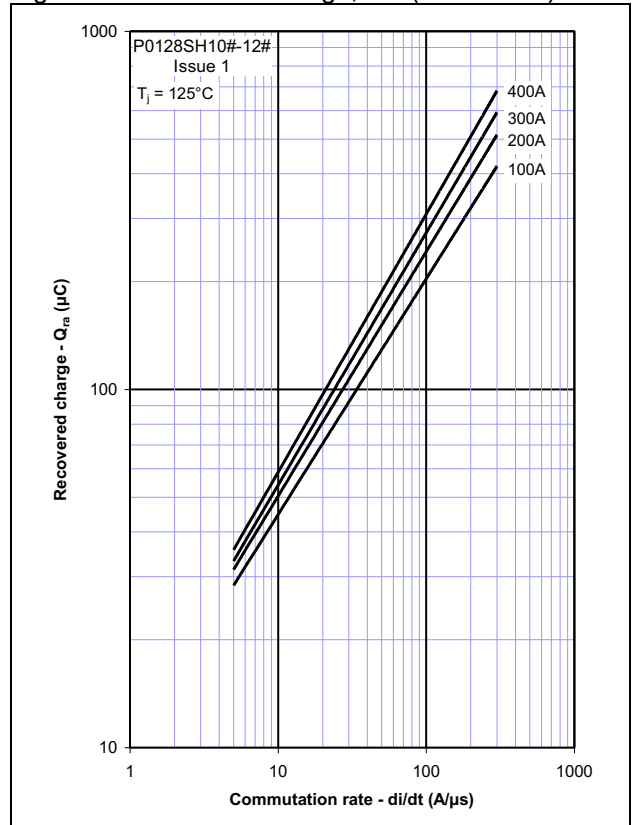

Figure 7 - Peak reverse recovery current,  $I_{rm}$

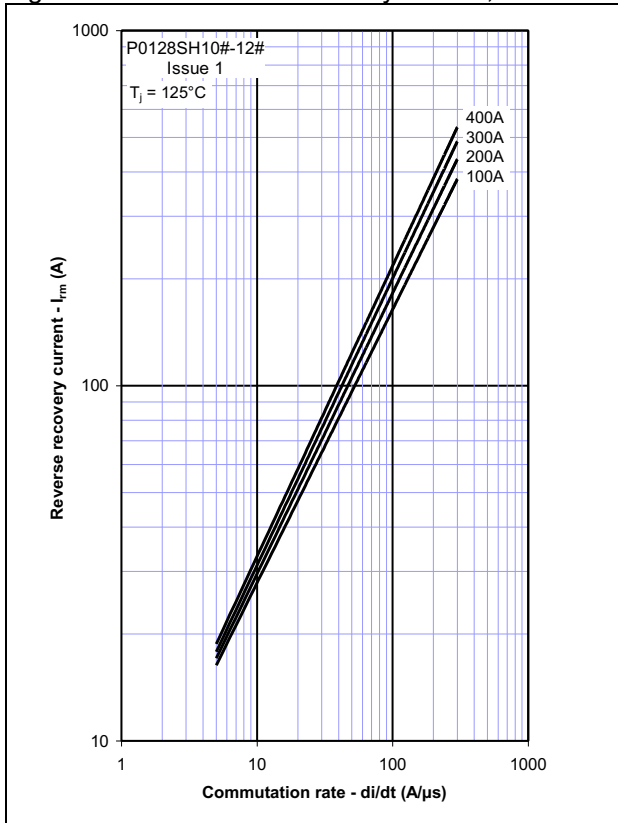

Figure 8 - Maximum recovery time,  $t_{rr}$  (50% chord)

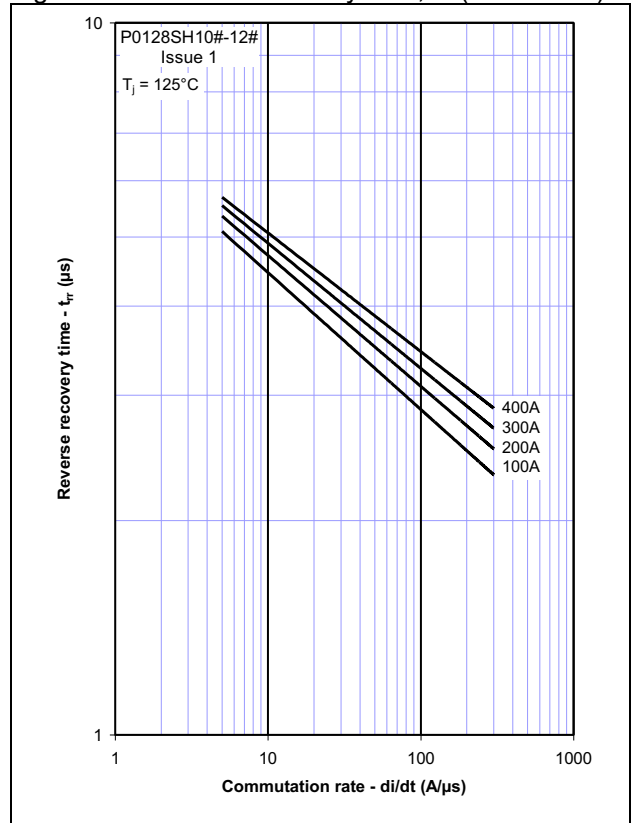



Figure 9 – Reverse recovery energy per pulse



Figure 10 - Sine wave energy per pulse



Figure 11 - Sine wave frequency ratings



Figure 12 - Sine wave frequency ratings



Figure 13 - Square wave frequency ratings



Figure 14 - Square wave frequency ratings

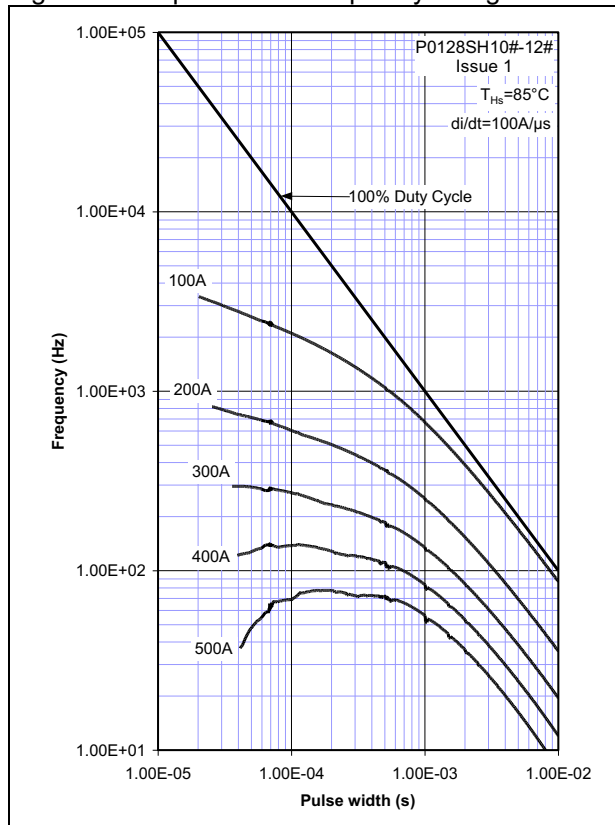

Figure 15 - Square wave frequency ratings



Figure 16 - Square wave frequency ratings

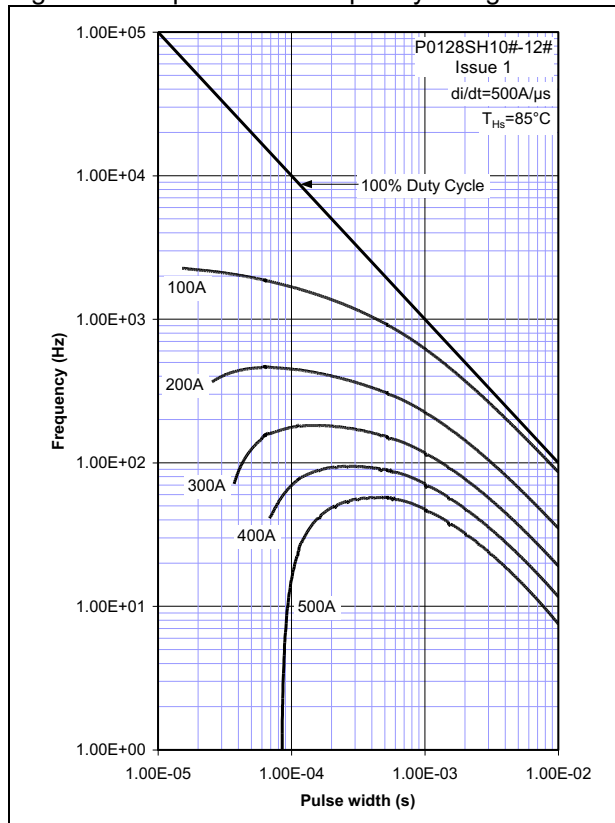

Figure 17 - Square wave energy per pulse

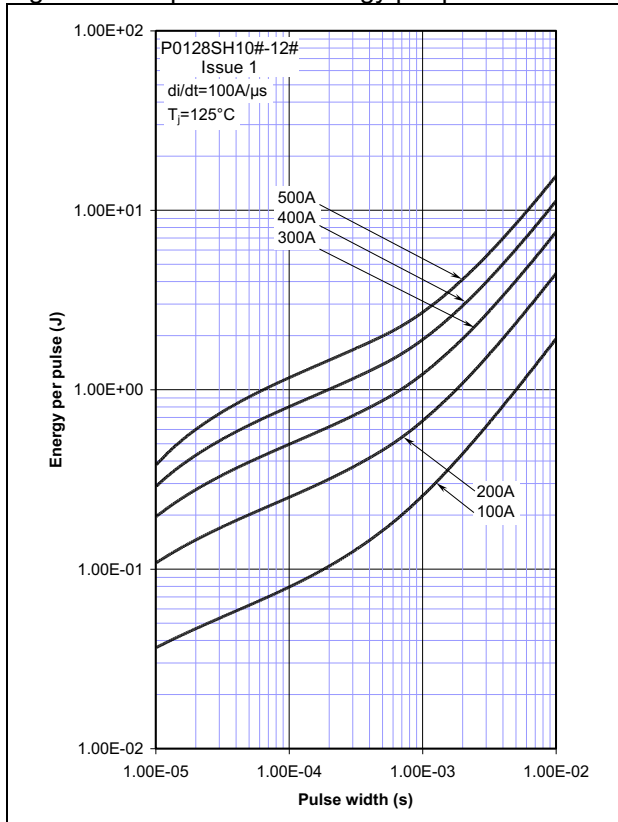

Figure 18 - Square wave energy per pulse

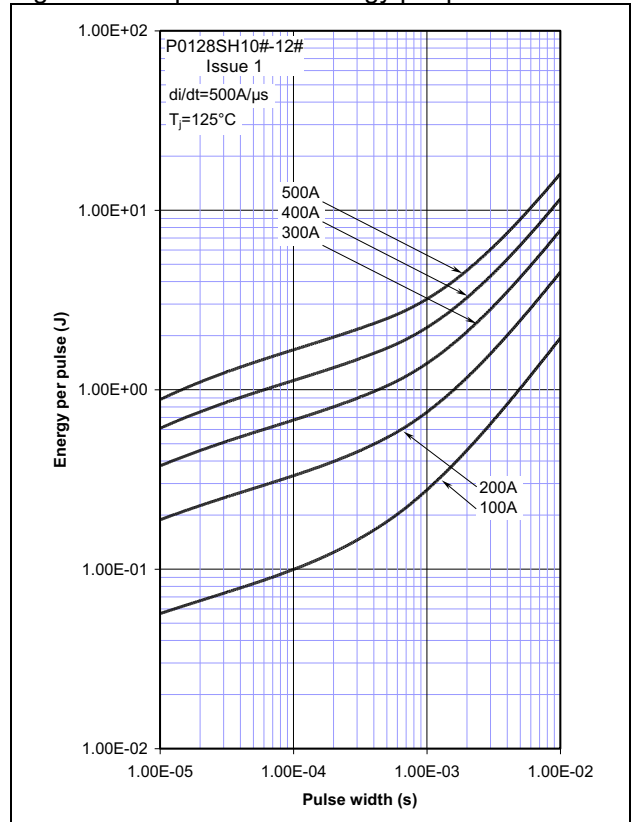
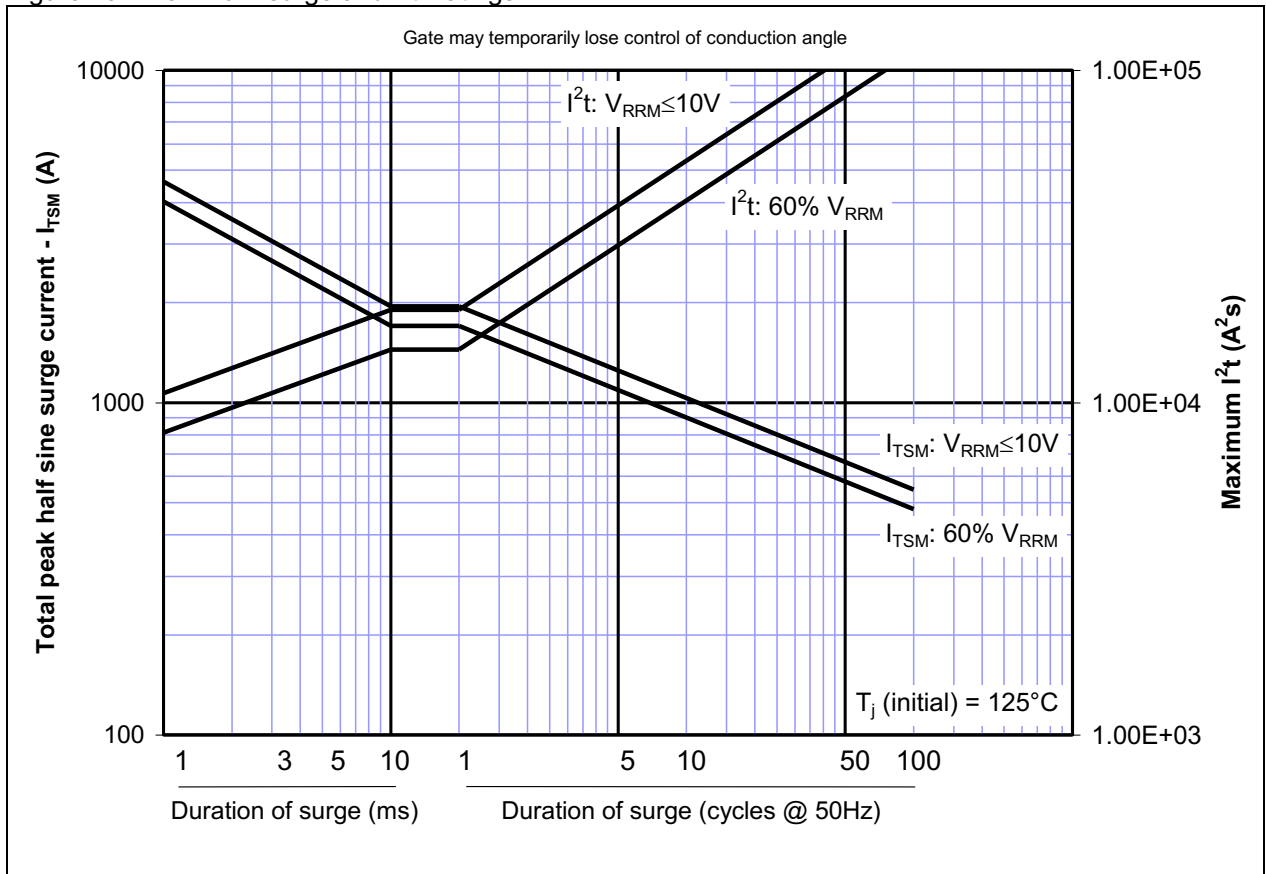

Figure 19 - Maximum surge and  $I^2t$  Ratings



**Outline Drawing & Ordering Information**



**ORDERING INFORMATION** (Please quote 10 digit code as below)

P0128	S	H	◆ ◆	#
Fixed Type Code	Fixed Polarity Code	Fixed Outline Code	Voltage Code V <sub>DRM</sub> /100 10-12	t <sub>q</sub> Code D=20μs, E=25μs

Typical order code: P0128SH10E – 1000V V<sub>DRM</sub>, V<sub>RRM</sub>, 25μs t<sub>q</sub>.

**IXYS Semiconductor GmbH**  
 Edisonstraße 15  
 D-68623 Lampertheim  
 Tel: +49 6206 503-0  
 Fax: +49 6206 503-627  
 E-mail: [marcom@ixys.de](mailto:marcom@ixys.de)

**WESTCODE**  
 An IXYS Company

**Westcode Semiconductors Ltd**  
 Langley Park Way, Langley Park,  
 Chippenham, Wiltshire, SN15 1GE.  
 Tel: +44 (0)1249 444524  
 Fax: +44 (0)1249 659448  
 E-mail: [WSL.sales@westcode.com](mailto:WSL.sales@westcode.com)

**IXYS Corporation**  
 3540 Bassett Street  
 Santa Clara CA 95054 USA  
 Tel: +1 (408) 982 0700  
 Fax: +1 (408) 496 0670  
 E-mail: [sales@ixys.com](mailto:sales@ixys.com)

[www.westcode.com](http://www.westcode.com)

[www.ixys.com](http://www.ixys.com)

**Westcode Semiconductors Inc**  
 3270 Cherry Avenue  
 Long Beach CA 90807 USA  
 Tel: +1 (562) 595 6971  
 Fax: +1 (562) 595 8182  
 E-mail: [WSI.sales@westcode.com](mailto:WSI.sales@westcode.com)

The information contained herein is confidential and is protected by Copyright. The information may not be used or disclosed except with the written permission of and in the manner permitted by the proprietors Westcode Semiconductors Ltd.

© Westcode Semiconductors Ltd.

In the interest of product improvement, Westcode reserves the right to change specifications at any time without prior notice.

Devices with a suffix code (2-letter, 3-letter or letter/digit/letter combination) added to their generic code are not necessarily subject to the conditions and limits contained in this report.