

DE10-Lite

User Manual

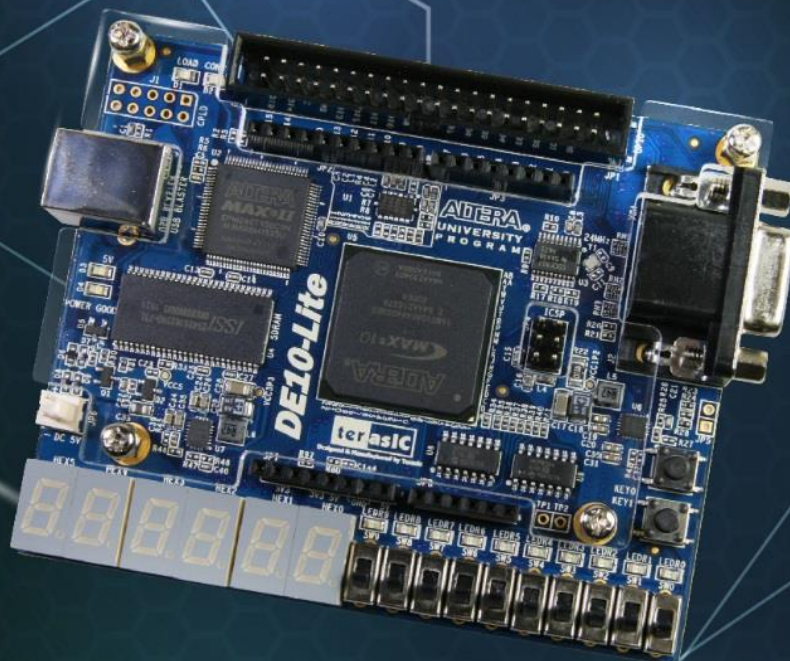

terasic
www.terasic.com

Copyright © 2003-2017 Terasic Inc. All Rights Reserved.

CONTENTS

Chapter 1	Introduction	3
1.1	Package Contents	3
1.2	DE10-Lite System CD	4
1.3	Layout and Components	4
1.4	Block Diagram of the Board	6
1.5	Getting Help.....	7
Chapter 2	Control Panel	8
2.1	Control Panel Setup.....	8
2.2	Controlling the LEDs, 7-segment Displays.....	10
2.3	Switches and Push-buttons.....	12
2.4	SDRAM Controller and Programmer	12
2.5	Accelerometer	14
2.6	VGA	15
2.7	Overall Structure of the DE10-Lite Control Panel.....	16
Chapter 3	Using the Starter Kit	17
3.1	Configuration of MAX 10 FPGA on DE10-Lite.....	17
3.2	Clock Circuitry.....	24
3.3	Using the Push-buttons, Switches and LEDs.....	25
3.4	Using the 7-segment Displays.....	28
3.5	Using 2x20 GPIO Expansion Headers	30
3.6	Using Arduino Uno R3 Expansion Header	32
3.7	A/D Converter and Analog Input	34
3.8	Using VGA.....	35
3.9	Using SDRAM.....	37
3.10	Using Accelerometer Sensor	39
Chapter 4	DE10-Lite System Builder	41
4.1	Introduction.....	41
4.2	General Design Flow.....	42

4.3	Using DE10-Lite System Builder	43
Chapter 5	Examples of Advanced Demonstrations.....	48
5.1	DE10-Lite Factory Configuration	48
5.2	SDRAM Test in Nios II.....	50
5.3	SDRAM Test in Verilog	53
5.4	VGA Pattern	55
5.5	G-Sensor.....	57
5.6	ADC Measurement.....	59
Chapter 6	Programming the Configuration Flash Memory	61
6.1	Internal Configuration.....	62
6.2	Using Dual Compressed Images	64

Chapter 1

Introduction

The DE10-Lite presents a robust hardware design platform built around the Altera MAX 10 FPGA. The MAX 10 FPGA is well equipped to provide cost effective, single-chip solutions in control plane or data path applications and industry-leading programmable logic for ultimate design flexibility. With MAX 10 FPGA, you can get lower power consumption / cost and higher performance. When you need high-volume applications, including protocol bridging, motor control drive, analog to digital conversion, image processing, and handheld devices, the MAX 10 Lite FPGA is your best choice.

The DE10-Lite development board includes hardware such as on-board USB Blaster, 3-axis accelerometer, video capabilities and much more. By leveraging all of these capabilities, the DE10-Lite is the perfect solution for showcasing, evaluating, and prototyping the true potential of the Altera MAX 10 FPGA.

The DE10-Lite contains all components needed to use the board in conjunction with a computer that runs the Win 7/Win 10 64-bit version or later.

1.1 Package Contents

Figure 1-1 shows a photograph of the DE10-Lite package.

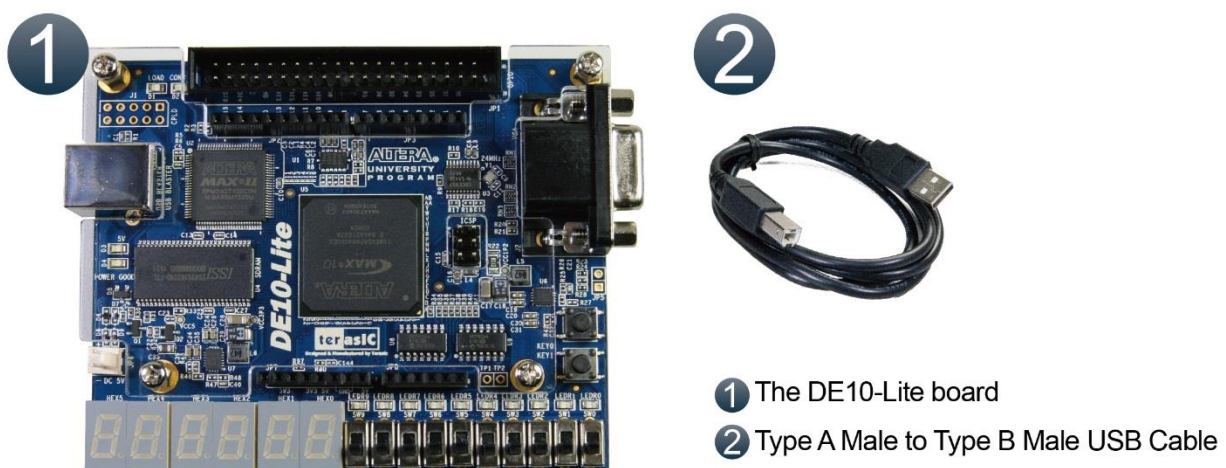

Figure 1-1 The DE10-Lite package contents

The DE10-Lite package includes:

- The DE10-Lite board
- Type A Male to Type B Male USB Cable

1.2 DE10-Lite System CD

The DE10-Lite System CD contains the documentation and supporting materials, including the User Manual, Control Panel, System Builder, reference designs and device datasheets.

User can download this System CD from the web (<http://DE10-Lite.terasic.com/cd>).

1.3 Layout and Components

This section presents the features and design characteristics of the board.

A photograph of the board is shown in **Figure 1-2** and **Figure 1-3**. It depicts the layout of the board and indicates the location of the connectors and key components.

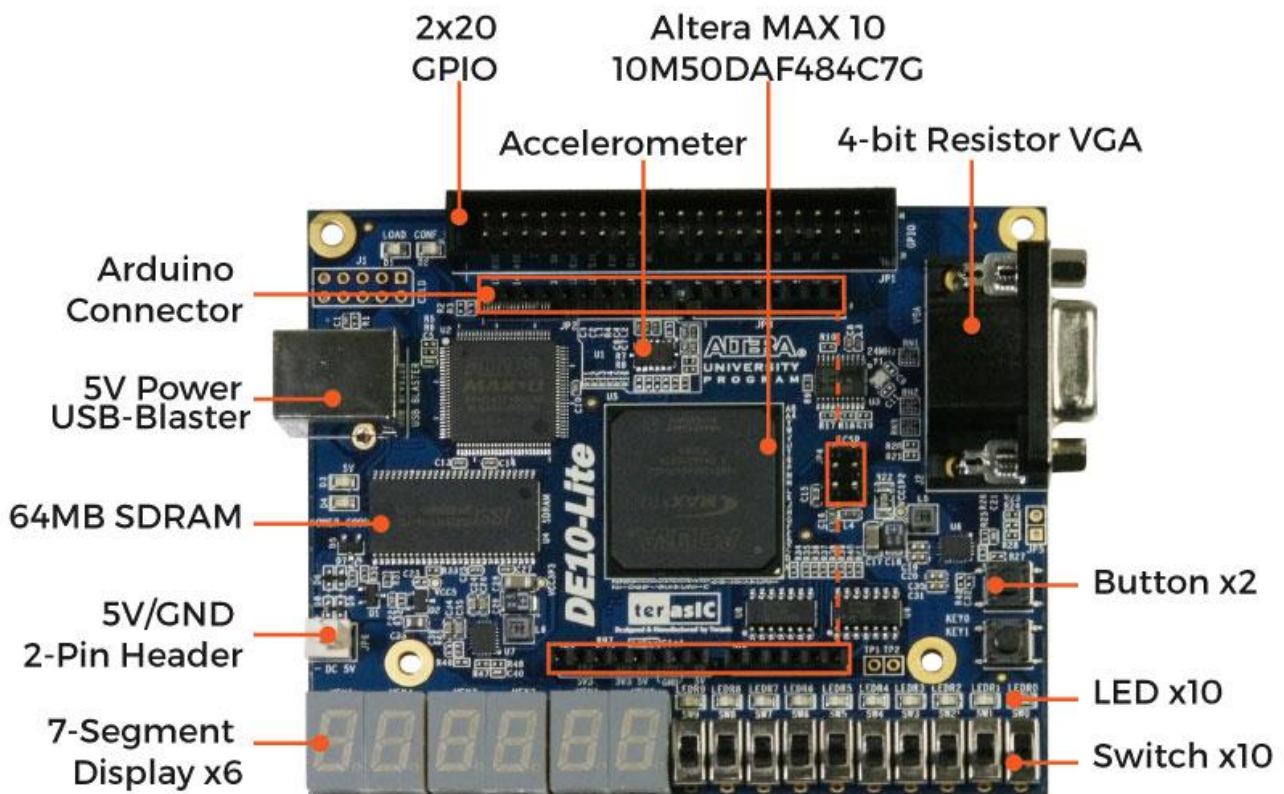

Figure 1-2 Development Board (top view)

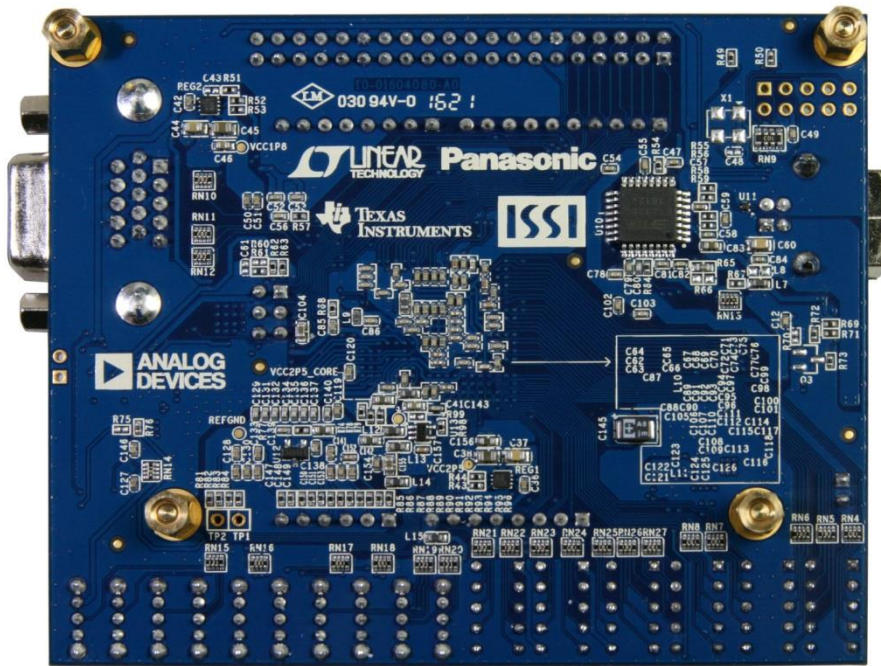

Figure 1-3 Development Board (bottom view)

This board has many features that allow users to implement a wide range of designed circuits, from simple circuits to various multimedia projects.

The following hardware are provided on the board:

FPGA Device

- MAX 10 10M50DAF484C7G Device
- Integrated dual ADCs, each ADC supports 1 dedicated analog input and 8 dual function pins
- 50K programmable logic elements
- 1,638 Kbits M9K Memory
- 5,888 Kbits user flash memory
- 144 18×18 Multiplier
- 4 PLLs

Programming and Configuration

- On-Board USB Blaster (Normal type B USB connector)

Memory Device

- 64MB SDRAM, x16 bits data bus

Connectors

- 2x20 GPIO Header
- Arduino Uno R3 Connector, including six ADC channels.

Display

- 4-bit resistor-network DAC for VGA (With 15-pin high-density D-sub connector)

Switches, Buttons and LEDs

- 10 LEDs
- 10 Slide Switches
- 2 Push Buttons with Debounced.
- Six 7-Segments

Power

- 5V DC input from USB or external power connector.

1.4 Block Diagram of the Board

Figure 1-4 gives the block diagram of the board. To provide maximum flexibility for the user, all connections are made through the MAX 10 FPGA device. Thus, the user can configure the FPGA to implement any system design.

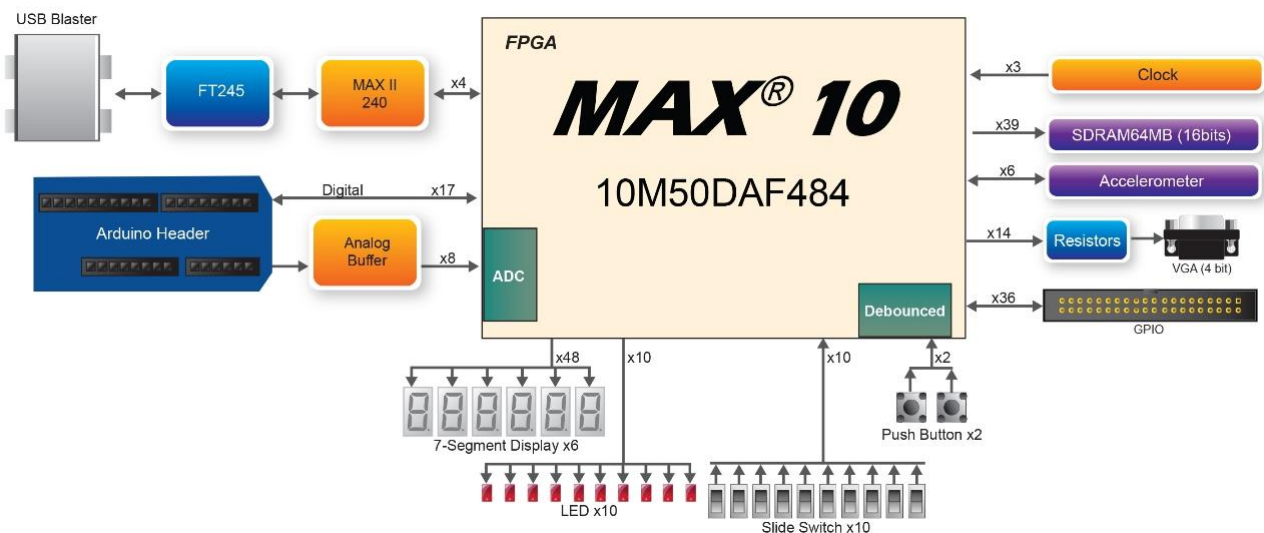

Figure 1-4 Board Block Diagram

1.5 Getting Help

Here are the addresses where you can get help if you encounter any problem:

- Terasic Inc.

9F., No.176, Sec.2, Gongdao 5th Rd, East Dist, Hsinchu City, 30070. Taiwan

Email: support@terasic.com

Tel.: +886-3-5750-880

Web: <http://DE10-Lite.terasic.com>

The DE10-Lite board comes with a Control Panel program that allows users to access various components on the board from a host computer. The host computer communicates with the board through a USB connection. The program can be used to verify the functionality of components on the board or be used as a debug tool while developing any RTL code.

This chapter first presents some basic functions of the Control Panel, then describes its structure in the block diagram form, and finally describes its capabilities.

2.1 Control Panel Setup

The Control Panel Software Utility is located in the directory “Tools/ControlPanel” in the **DE10-Lite System CD**. It's free of installation, just copy the whole folder to your host computer and launch the control panel by executing the “DE10_Lite_ControlPanel.exe”.

Specific control circuits should be downloaded to your FPGA board before the control panel can request it to perform required tasks. The program will call Quartus Prime tools to download the control circuit to the FPGA board through the USB-Blaster [USB-0] connection.

To activate the Control Panel, perform the following steps:

1. Make sure Quartus Prime 16.0 or a later version is installed successfully on your PC.
2. Connect the USB cable provided to the USB Blaster port.
3. Download bin32 folder from link <http://mail.terasic.com.cn/~wyzhou/bin32.zip> , unzip and copy the bin32 folder to the <Path to Quartus Prime installation>\quartus folder (for example: C:\intelFPGA\16.0\quartus).

Note: DE10_Lite_ControlPanel is created to support working with 32bit OS. However, it does not support the 32bit OS in the Quartus Prime 15.1 or later.

4. Start the executable *DE10_Lite_ControlPanel.exe* on the host computer. The Control Panel user interface shown in **Figure 2-1** will appear.

5. The DE10_Lite_ControlPanel.sof bit stream is loaded automatically as soon as the *DE10_Lite_ControlPanel.exe* is launched.

6. In case of a disconnection, click on CONNECT where the .sof will be re-loaded onto the board.

Please note that the Control Panel will occupy the USB port until you close that port; you cannot use Quartus II to download a configuration file into the FPGA until the USB port is closed.

7. The Control Panel is now ready to use; experience it by setting the ON/OFF status for some LEDs and observing the result on the DE10-Lite board.



Figure 2-1 The DE10-Lite Control Panel

The concept of the DE10-Lite Control Panel is illustrated in **Figure 2-2**. The “Control Circuit” that performs the control functions is implemented in the FPGA board. It communicates with the Control Panel window, which is active on the host computer, via the USB Blaster link. The graphical interface is used to send commands to the control circuit. It handles all the requests and performs data transfers between the computer and the DE10-Lite board.

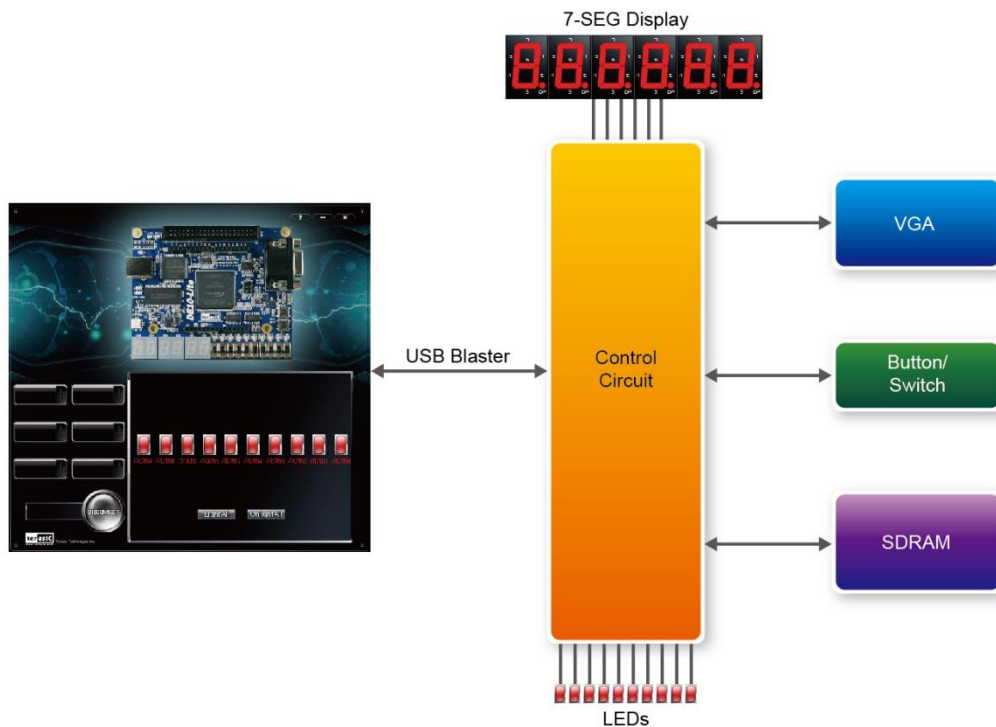

Figure 2-2 The DE10-Lite Control Panel concept

The DE10-Lite Control Panel can be used to light up LEDs, change the values displayed on the 7-segment, monitor buttons/switches status, read/write the SDRAM Memory, output VGA color pattern to VGA monitor. The feature of reading/writing a word or an entire file from/to the Memory allows the user to develop multimedia applications without worrying about how to build a Memory Programmer.

2. 2 Controlling the LEDs, 7-segment Displays

A simple function the Control Panel is capable of is the modification of settings for the 7-segment LED displays.

Choosing the **LED** tab leads you to the window in **Figure 2-3**. Here, you can directly turn the LEDs on or off individually or by clicking “Light All” or “Unlight All”.



Figure 2-3 Controlling LEDs

Choosing the 7-SEG tab leads you to the window shown in **Figure 2-4**. From the window, directly use the left-right arrows to control the 7-SEG patterns on the DE10-Lite board which are updated immediately. Note that the dots of the 7-SEGs are not enabled on the DE10-Lite board.

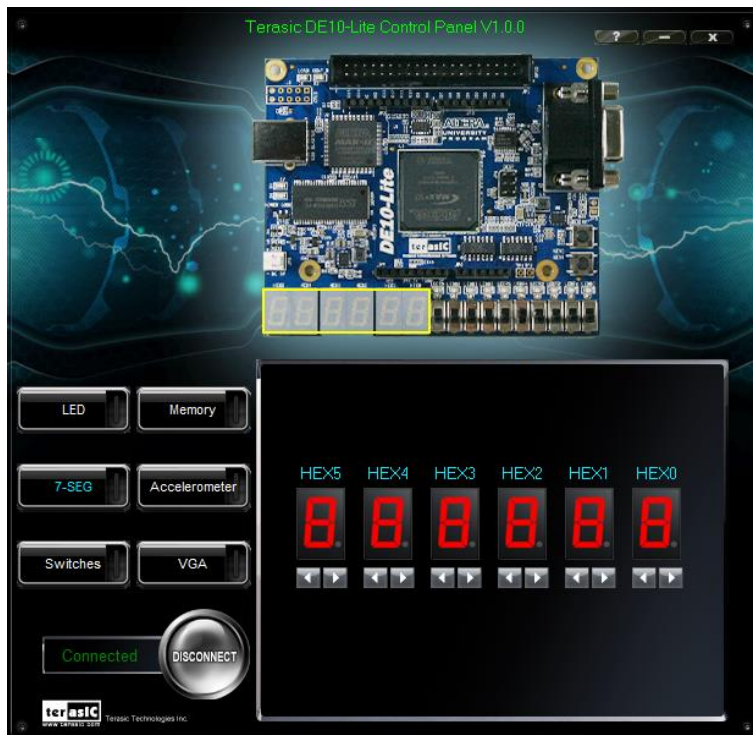

Figure 2-4 Controlling 7-SEG display

The ability to set arbitrary values into simple display devices is not needed in typical design activities. However, it gives users a simple mechanism for verifying that these devices are functioning correctly in case a malfunction is suspected. Thus, it can be used for troubleshooting purposes.

2.3 Switches and Push-buttons

Choosing the Switches tab leads you to the window in **Figure 2-5**. The function is designed to monitor the status of slide switches and push buttons in real time and show the status in a graphical user interface. It can be used to verify the functionality of the slide switches and push-buttons.



Figure 2-5 Monitoring switches and buttons

The ability to check the status of push-button and slide switch is not needed in typical design activities. However, it provides users a simple mechanism to verify if the buttons and switches are functioning correctly. Thus, it can be used for troubleshooting purposes.

2.4 SDRAM Controller and Programmer

The Control Panel can be used to write/read data to/from the SDRAM chips on the DE10-Lite board. As shown below, we will describe how the SDRAM may be accessed; Click on the Memory tab and select “SDRAM” to reach the window in **Figure 2-6**.



Figure 2-6 Accessing the SDRAM

A 8-bit word can be written into the SDRAM by entering the address of the desired location, specifying the data to be written, and pressing the Write button. Contents of the location can be read by pressing the Read button. **Figure 2-6** depicts the result of writing the **hexadecimal** value AB into **hexadecimal** offset address C00, followed by reading the same location.

The Sequential Write function of the Control Panel is used to write the contents of a file into the SDRAM as follows:

1. Specify the hexadecimal starting address in the Address box.
2. Specify the hexadecimal number of bytes to be written in the Length box. If the entire file is to be loaded, then a checkmark may be placed in the File Length box instead of giving the number of bytes.
3. To initiate the writing process, click on the Write a File to Memory button.
4. When the Control Panel responds with the standard Windows dialog box asking for the source file, specify the desired file location in the usual manner.

The Control Panel also supports loading files with a .hex extension. Files with a .hex extension are ASCII text files that specify memory values using ASCII characters to represent hexadecimal values. For example, a file containing the line

0123456789ABCDEF

defines eight 8-bit values: 01, 23, 45, 67, 89, AB, CD, EF. These values will be loaded consecutively into the memory.

The Sequential Read function is used to read the contents of the SDRAM and fill them into a file as follows:

1. Specify the hexadecimal starting address in the Address box.
2. Specify the hexadecimal number of bytes to be copied into the file in the Length box. If the entire contents of the SDRAM are to be copied (which involves all 64 Mbytes), then place a checkmark in the Entire Memory box.
3. Press Load Memory Content to a File button.
4. When the Control Panel responds with the standard Windows dialog box asking for the destination file, specify the desired file in the usual manner.

2.5 Accelerometer

The G-Sensor in the accelerometer utilizes a spirit level to function. The user can rotate the DE10-Lite board different directions, up or down, left or right. The bubble will travel quickly in respect to the user's movements. Meanwhile, the control panel will show the accelerated data in x-axis, y-axis and z-axis as shown in **Figure 2-7**. Note that the resolution measurement of 3-axes accelerometer is set to +/- 2g.



Figure 2-7 Level by G-Sensor

2.6 VGA

DE10-Lite Control Panel provides VGA pattern function that allows users to output color pattern to LCD/CRT monitor using the DE10-Lite board. Follow the steps below to generate the VGA pattern function:

Choosing the VGA tab leads you to the window in **Figure 2-8**.

Plug a D-sub cable to the VGA connector of the DE10-Lite board and LCD /CRT monitor.

The LCD/CRT monitor will display the same color pattern on the control panel window.

Click the drop down menu shown in **Figure 2-8** where you can output the selected pattern individually.

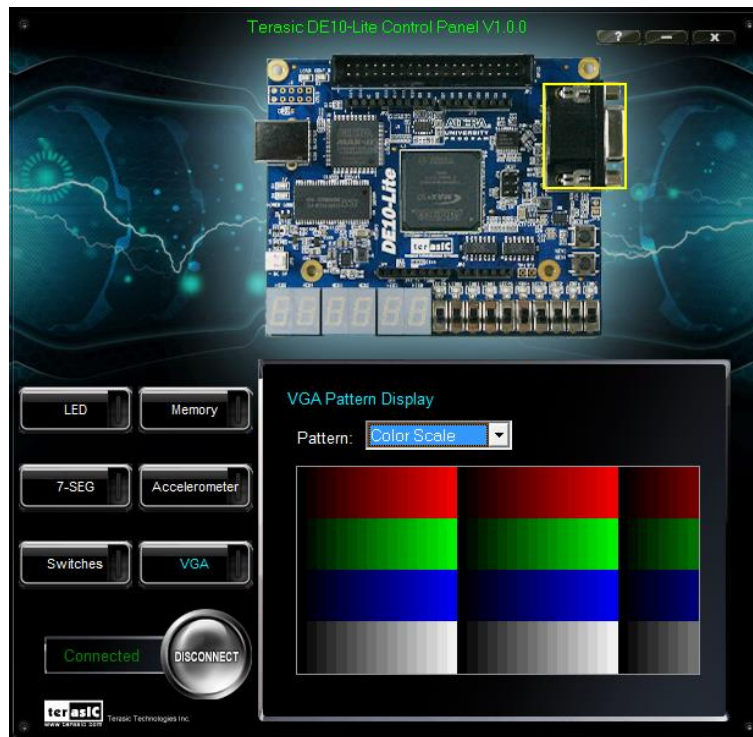

Figure 2-8 Controlling VGA display under Control Panel

2.7 Overall Structure of the DE10-Lite Control Panel

The DE10-Lite Control Panel is based on a Nios II Qsys system instantiated in the MAX 10 FPGA with software running on the on-chip memory. The software was implemented in coding Language C; and the hardware was implemented in Verilog HDL code with Qsys builder. The source code is not available on the DE10-Lite System CD.

To run the Control Panel, users should follow the configuration setting according to Section 3.1. **Figure 2-9** depicts the structure of the Control Panel. Each input/output device is controlled by the Nios II Processor instantiated in the FPGA chip. The communication with the PC is done via the USB Blaster link. The Nios II interprets the commands sent from the PC and performs the corresponding actions.

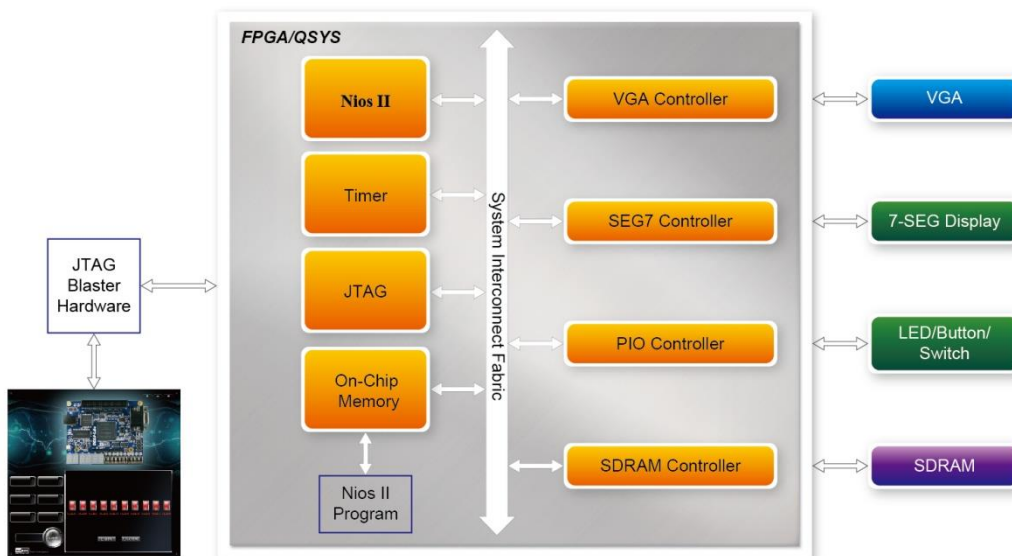

Figure 2-9 The block diagram of the DE10-Lite control panel

This chapter provides instructions to use the board and describes the peripherals.

3.1 Configuration of MAX 10 FPGA on DE10-Lite

There are two types of configuration method supported by DE10-Lite:

1. JTAG configuration: configuration using JTAG ports.

JTAG configuration scheme allows you to directly configure the device core through JTAG pins - TDI, TDO, TMS, and TCK pins. The Quartus II software automatically generates .sof files that are used for JTAG configuration with a download cable in the Quartus II software program.

2. Internal configuration: configuration using internal flash.

Before internal configuration, you need to program the configuration data into the configuration flash memory (CFM) which provides non-volatile storage for the bit stream. The information is retained within CFM even if the DE10-Lite board is turned off. When the board is powered on, the configuration data in the CFM is automatically loaded into the MAX 10 FPGA.

■ JTAG Chain on DE10-Lite Board

The FPGA device can be configured through JTAG interface on DE10-Lite board, but the JTAG chain must form a closed loop, which allows Quartus II programmer to detect FPGA device. **Figure 3-1** illustrates the JTAG chain on DE10-Lite board

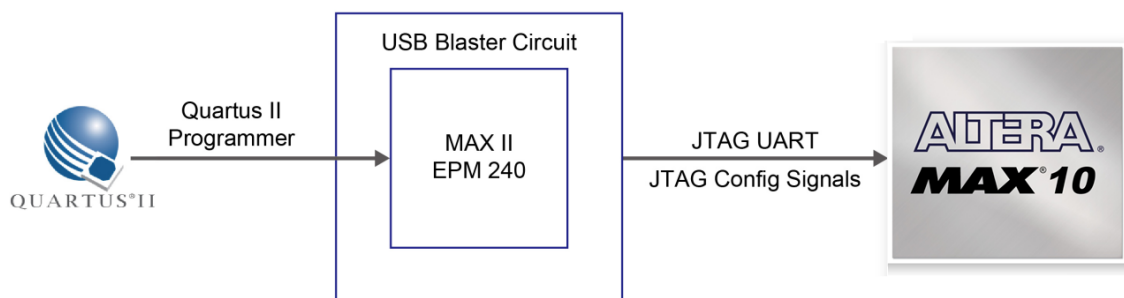

Figure 3-1 The JTAG configuration scheme

■ Configure the FPGA in JTAG Mode

The following shows how the FPGA is programmed in JTAG mode step by step.

1. Open the Quartus II programmer, please Choose Tools > Programmer. The Programmer window opens. See [Figure 3-2](#).

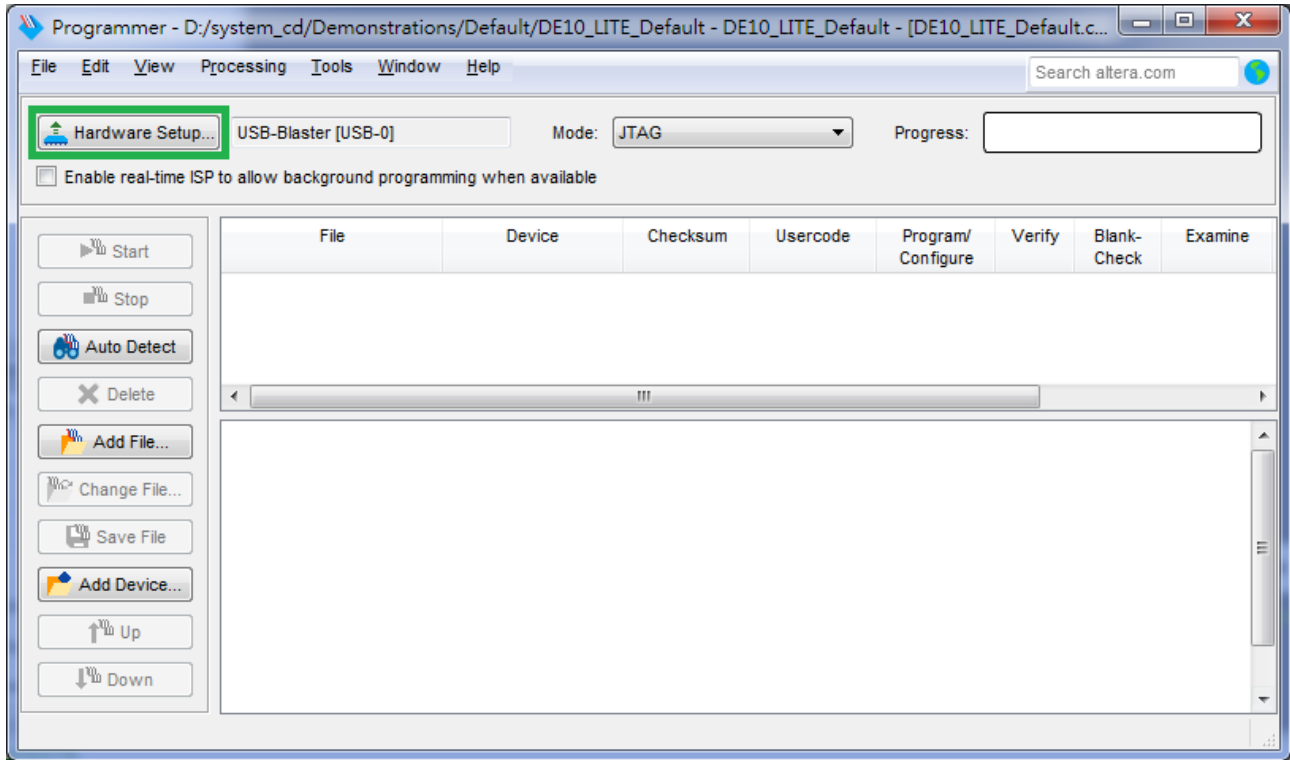

Figure 3-2 Programmer Window

2. Click “Hardware Setup”, as circled in [Figure 3-2](#).
3. If it is not already turned on, turn on the USB-Blaster [USB-0] option under currently selected hardware and click “Close” to close the window. See [Figure 3-3](#).

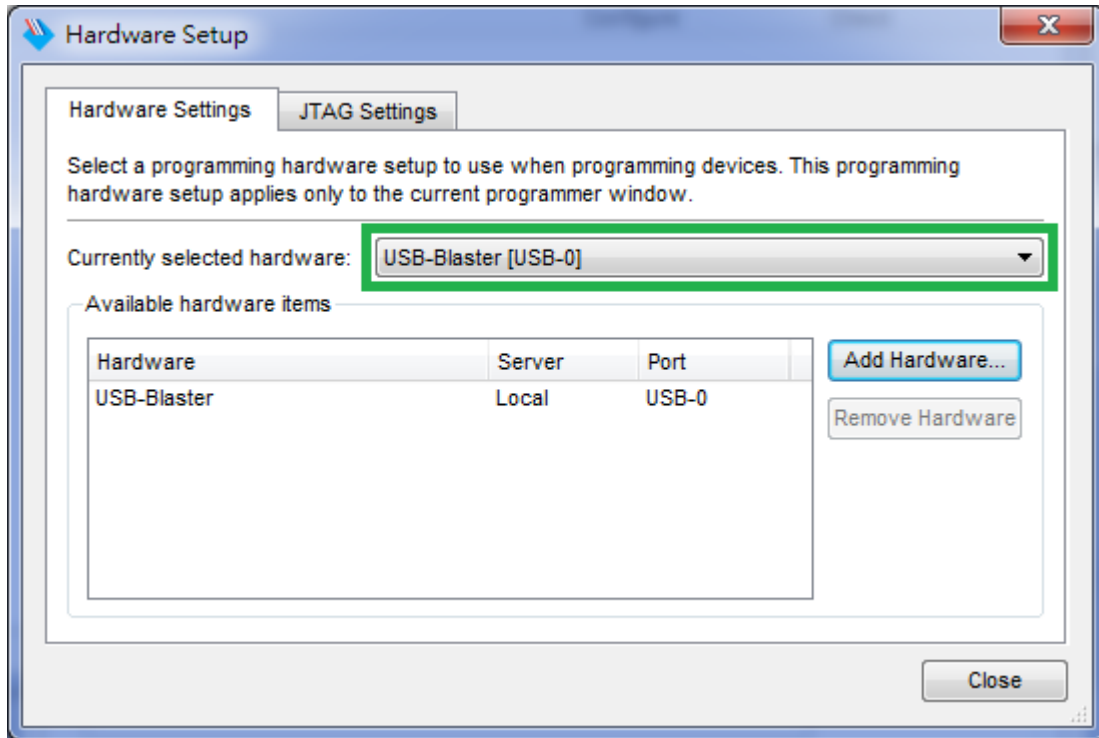

Figure 3-3 Hardware Setting

4. Click “Auto Detect” to detect all the devices on the JTAG chain, as circled in **Figure 3-4**.

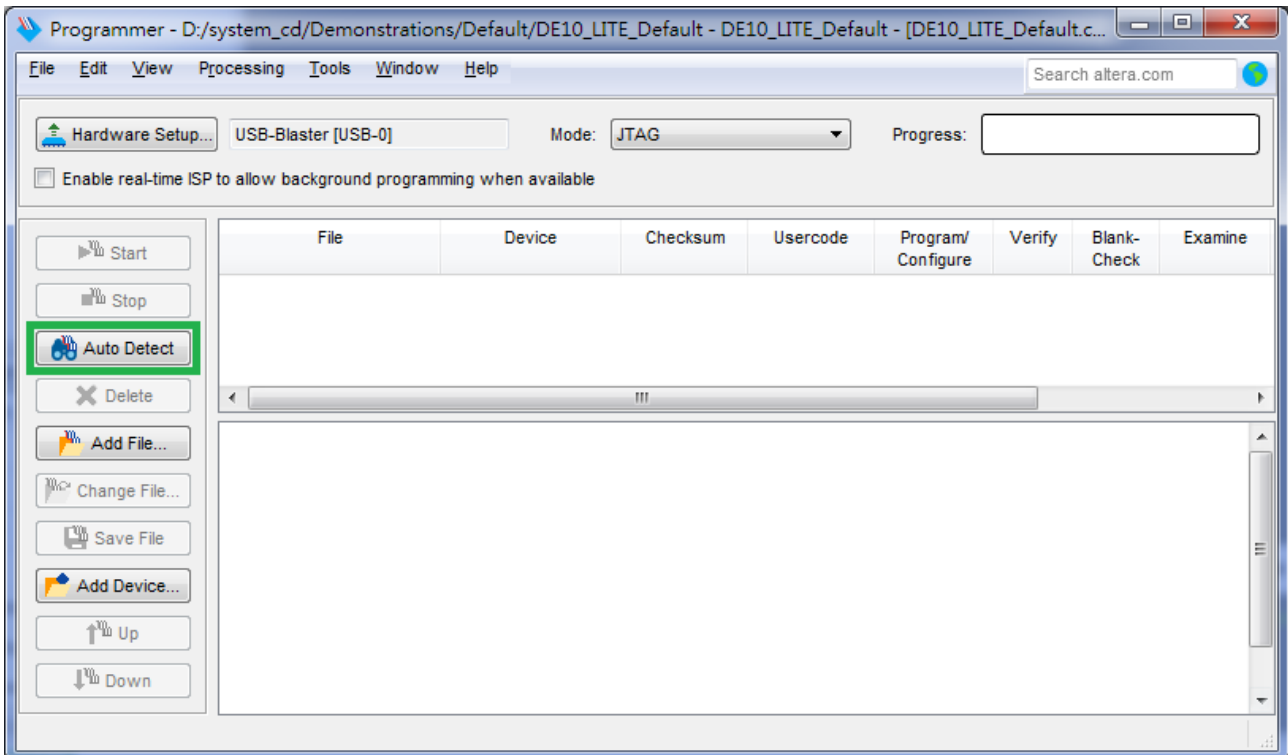

Figure 3-4 Detect FPGA device in JTAG mode

5. Select detected device associated with the board, as circled in **Figure 3-5**.

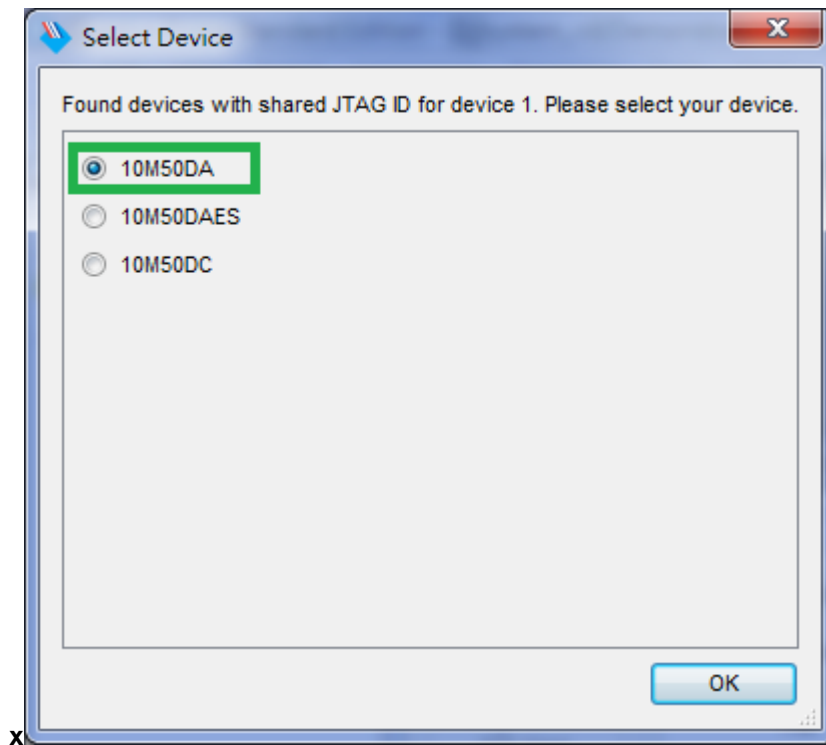

Figure 3-5 Select 10M50DA device

6. FPGA is detected, as shown in **Figure 3-6**.

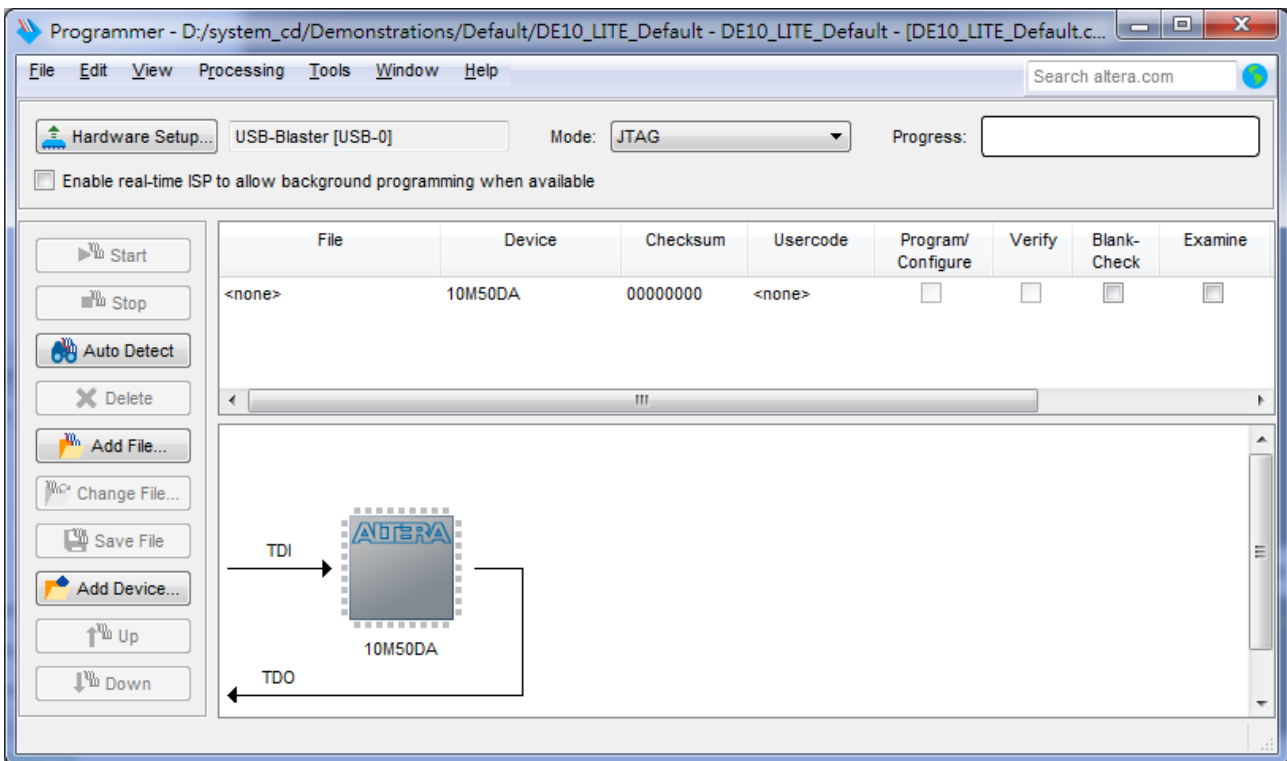

Figure 3-6 FPGA detected in Quartus II programmer

- Right click on the FPGA device and click “Change File” to open the .sof file to be programmed, as highlighted in **Figure 3-7**.

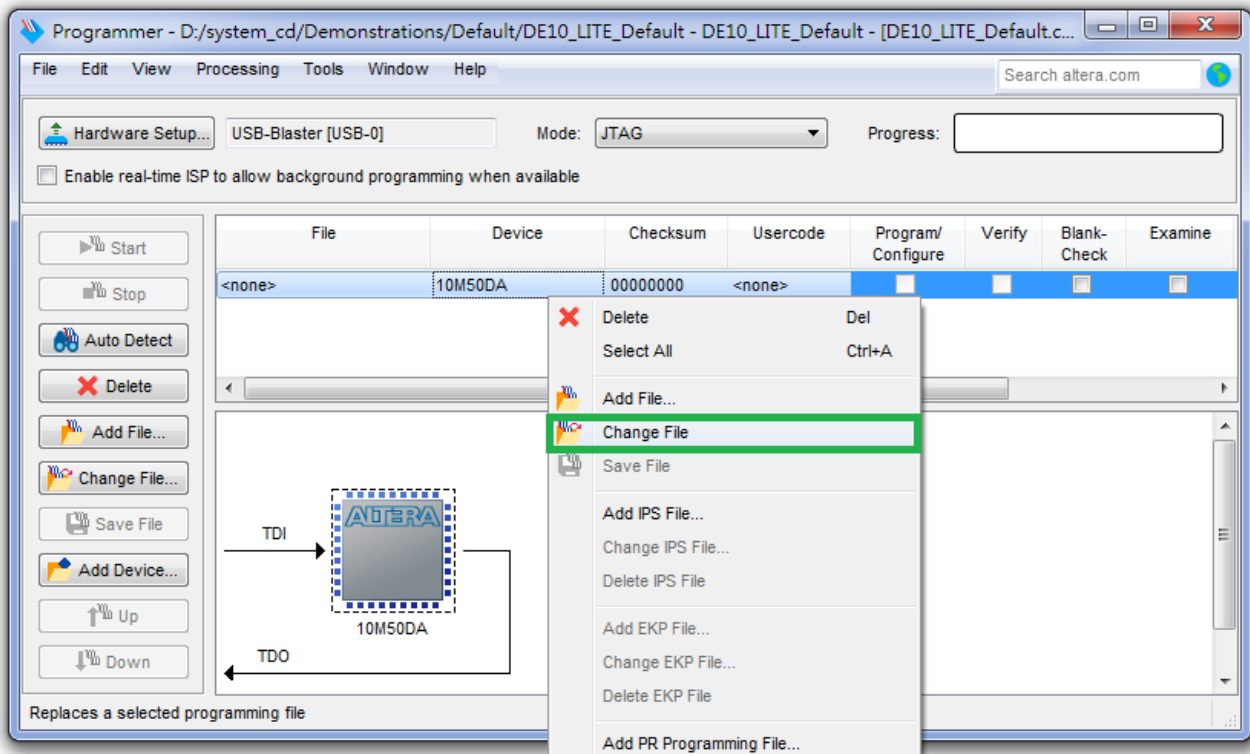

Figure 3-7 Open the .sof file to be programmed into the FPGA device

- Select the .sof file to be programmed, as shown in **Figure 3-8**.

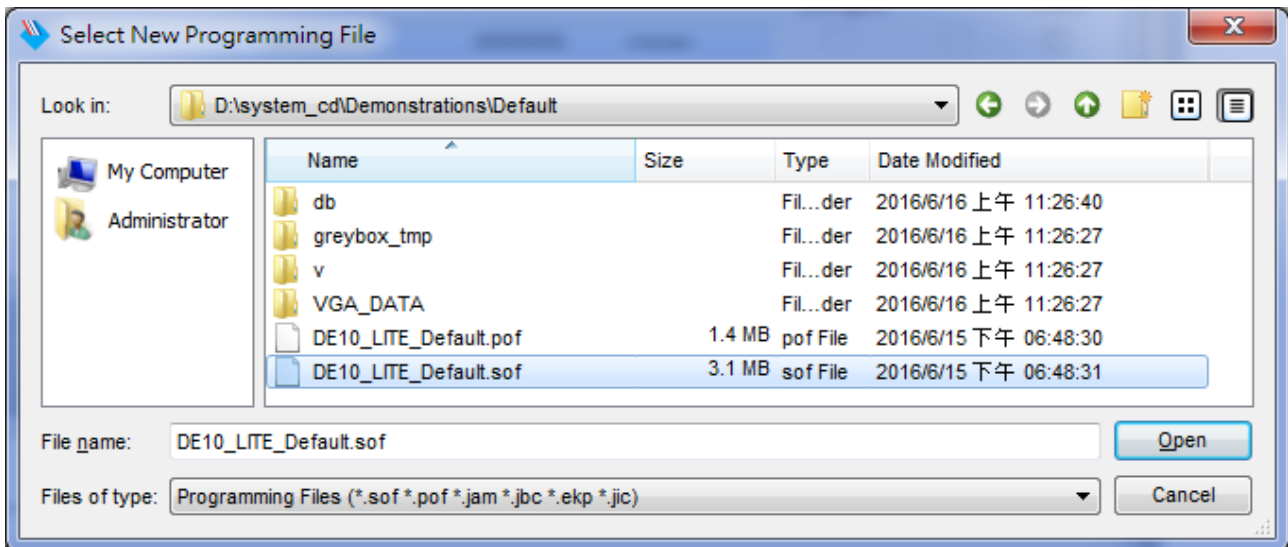

Figure 3-8 Select the .sof file to be programmed into the FPGA device

- Click “Program/Configure” check box and then click “Start” button to download the .sof file into the FPGA device, as shown in **Figure 3-9**.

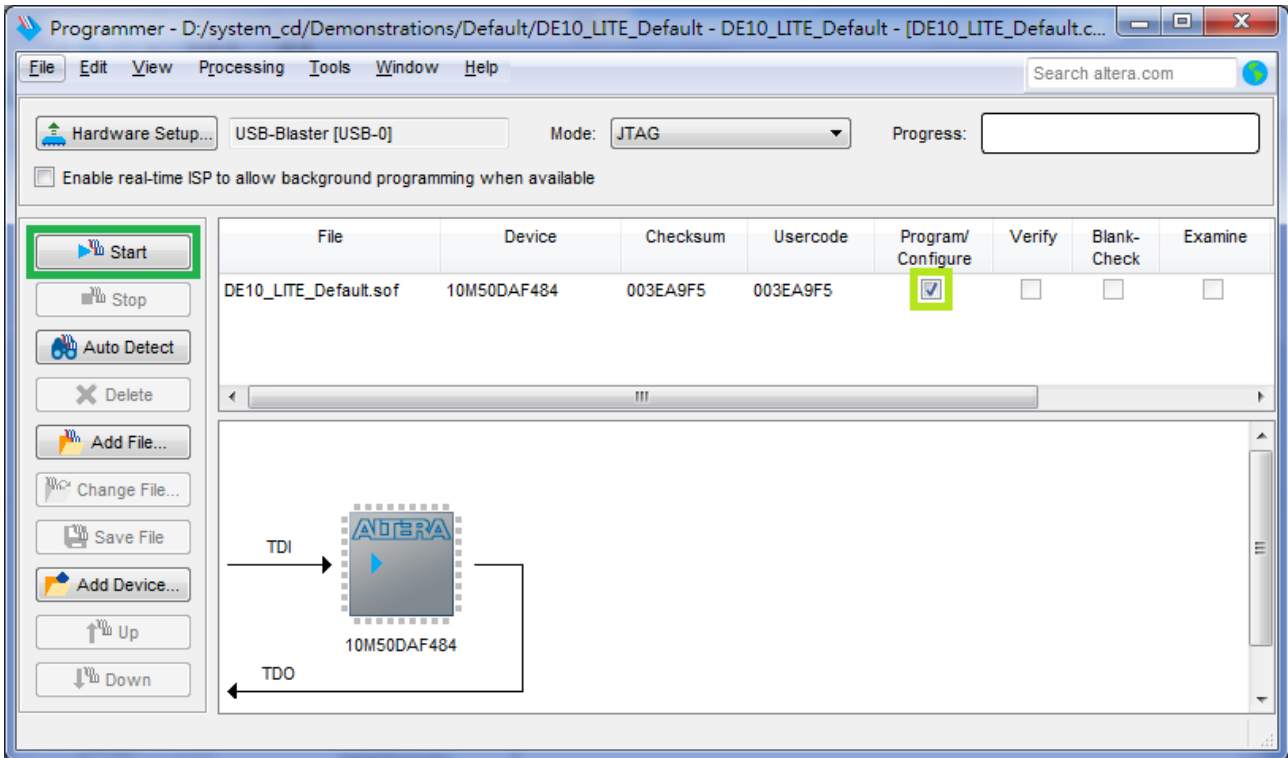

Figure 3-9 Program .sof file into the FPGA device

■ Internal Configuration

- The configuration data to be written to CFM will be part of the programmer object file (.pof). This configuration data is automatically loaded from the CFM into the MAX 10 devices when the board is powered up.
- Please refer to Chapter 8: Programming the Configuration Flash Memory (CFM) for the basic programming instruction on the configuration flash memory (CFM).

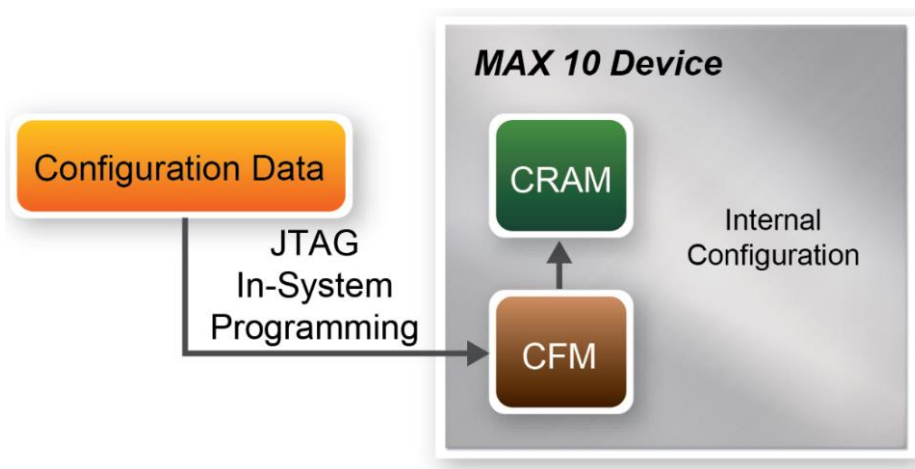

Figure 3-10 High-Level Overview of Internal Configuration for MAX 10 Devices

■ Status LED

The DE10-Lite development board includes board-specific status LEDs to indicate board status. Please refer to **Table 3-1** for the description of the LED indicator. Please refer to **Figure 3-11** for detailed LED location.

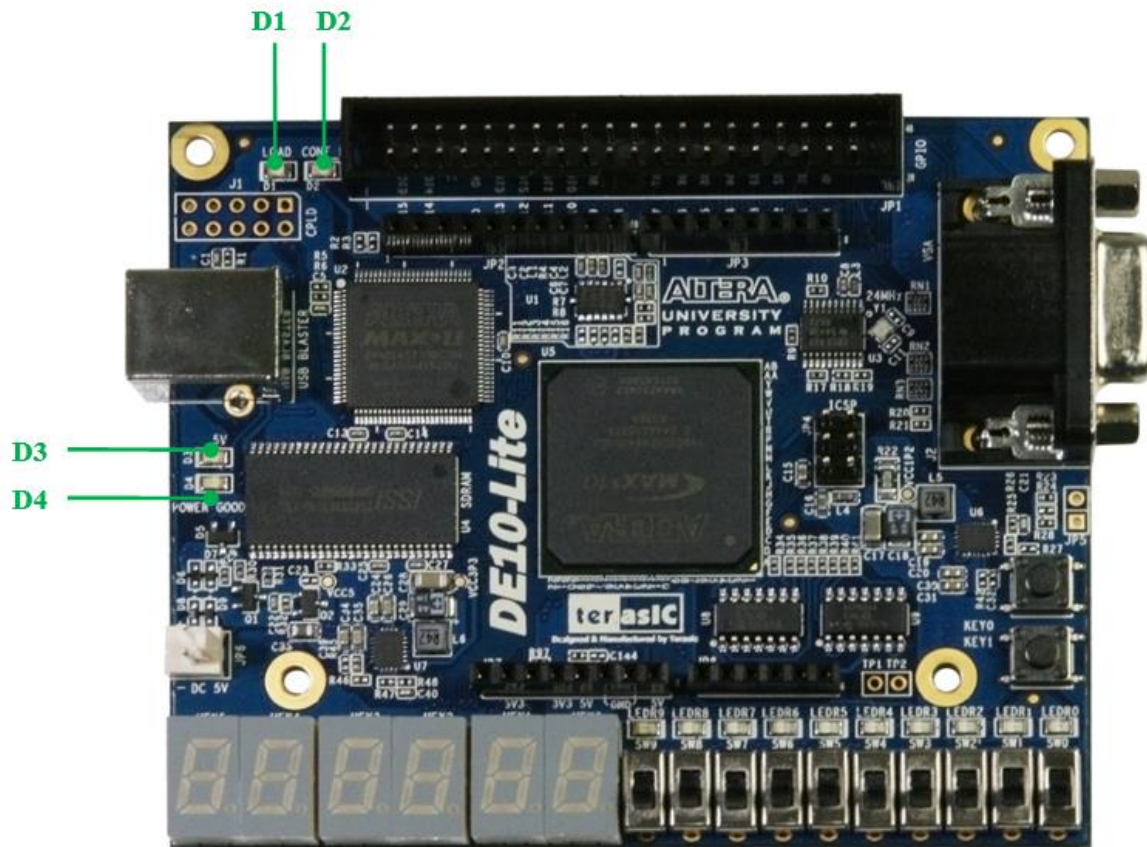

Figure 3-11 Status LED position

Table 3-1 Status LED

Reference	LED Name	Description
D1	ULED	Illuminates when the on-board USB-Blaster is working
D2	CONF_DONE	Illuminates when the FPGA is successfully configured.
D3	5V	Illuminates when Input power is active. Not Installed.
D4	Power Good	Illuminates when board power system is OK.

3.2 Clock Circuitry

Figure 3-12 shows the default frequency of all external clocks to the MAX 10 FPGA. A clock generator is used to distribute clock signals with low jitter. The two 50MHz clock signals connected to the FPGA are used as clock sources for user logic. One 24MHz clock signal is connected to the clock inputs of USB microcontroller of USB Blaster. One 10MHz clock signal is connected to the PLL1 and PLL3 of FPGA, the outputs of these two PLLs can drive ADC clock. The associated pin assignment for clock inputs to FPGA I/O pins is listed in Table 3-2.

Warning !!

Do not modify the clock generator settings.

Incorrect setting will cause the system to not work.

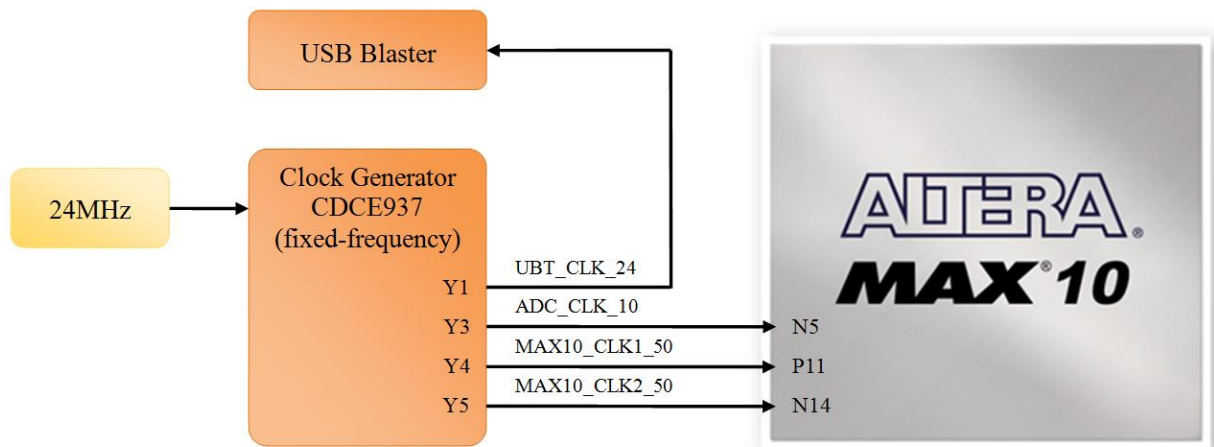

Figure 3-12 Clock circuit of the FPGA Board

Table 3-2 Pin Assignment of Clock Inputs

Signal Name	FPGA Pin No.	Description	I/O Standard
ADC_CLK_10	PIN_N5	10 MHz clock input for ADC (Bank 3B)	3.3-V LVTTTL
MAX10_CLK1_50	PIN_P11	50 MHz clock input(Bank 3B)	3.3-V LVTTTL
MAX10_CLK2_50	PIN_N14	50 MHz clock input(Bank 3B)	3.3-V LVTTTL

3.3 Using the Push-buttons, Switches and LEDs

■ User-Defined Push-buttons

The board includes two user defined push-buttons that allow users to interact with the MAX 10 FPGA device. Each of these switches is debounced using a Schmitt Trigger circuit as indicated in **Figure 3-13**. A Schmitt trigger feature introduces hysteresis to the input signal for improved noise immunity, especially for signal with slow edge rate and act as switch debounce in **Figure 3-14** for the push-buttons connected. **Table 3-3** list the pin assignment of user push-buttons.

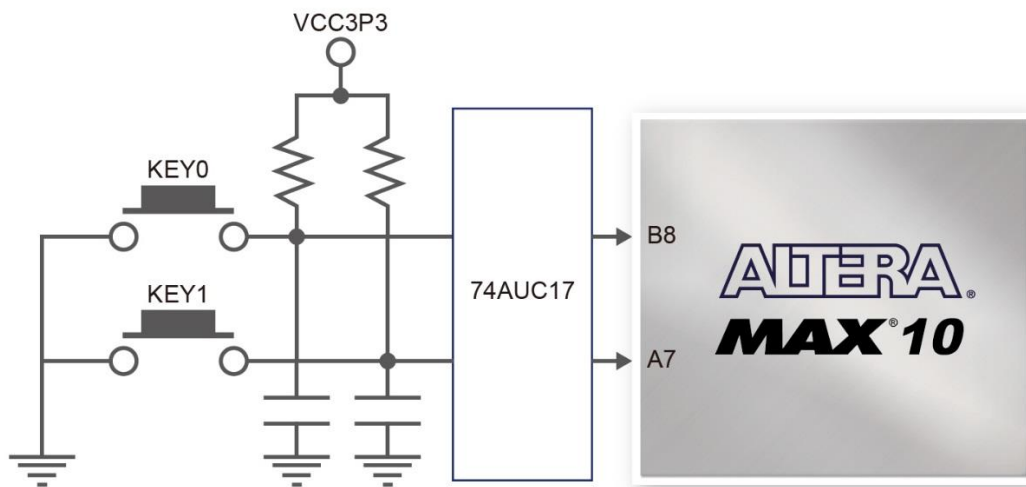

Figure 3-13 Connections between the push-button and MAX 10 FPGA

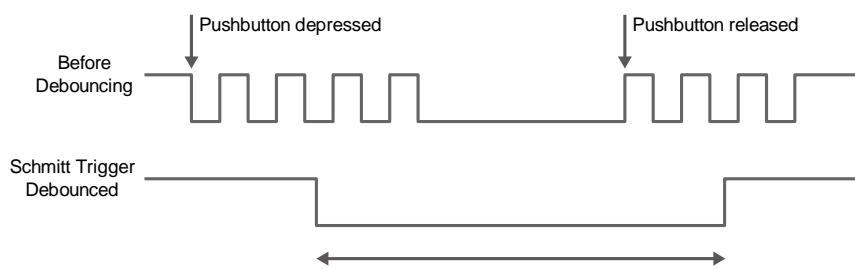

Figure 3-14 Switch debouncing

Table 3-3 Pin Assignment of Push-buttons

Signal Name	FPGA Pin No.	Description	I/O Standard
KEY0	PIN_B8	Push-button[0]	3.3 V SCHMITT TRIGGER"
KEY1	PIN_A7	Push-button[1]	3.3 V SCHMITT TRIGGER"

■ User-Defined Slide Switch

There are ten slide switches connected to FPGA on the board (See [Figure 3-15](#)). These switches are used as level-sensitive data inputs to a circuit. Each switch is connected directly and individually to a pin on the MAX 10 FPGA. When the switch is in the DOWN position (closest to the edge of the board), it provides a low logic level to the FPGA, and when the switch is in the UP position it provides a high logic level. [Table 3-4](#) list the pin assignments of the user switches.



Figure 3-15 Connections between the slide switches and MAX 10 FPGA

Table 3-4 Pin Assignment of Slide Switches

Signal Name	FPGA Pin No.	Description	I/O Standard
SW0	PIN_C10	Slide Switch[0]	3.3-V LVTTTL
SW1	PIN_C11	Slide Switch[1]	3.3-V LVTTTL
SW2	PIN_D12	Slide Switch[2]	3.3-V LVTTTL
SW3	PIN_C12	Slide Switch[3]	3.3-V LVTTTL
SW4	PIN_A12	Slide Switch[4]	3.3-V LVTTTL
SW5	PIN_B12	Slide Switch[5]	3.3-V LVTTTL
SW6	PIN_A13	Slide Switch[6]	3.3-V LVTTTL
SW7	PIN_A14	Slide Switch[7]	3.3-V LVTTTL
SW8	PIN_B14	Slide Switch[8]	3.3-V LVTTTL
SW9	PIN_F15	Slide Switch[9]	3.3-V LVTTTL

■ User-Defined LEDs

There are also ten user-controllable LEDs connected to FPGA on the board. Each LED is driven directly and individually by a pin on the MAX 10 FPGA; driving its associated pin to a high logic level turns the LED on, and driving the pin low turns it off. **Figure 3-16** shows the connections between LEDs and MAX 10 FPGA. **Table 3-5** list the pin assignment of user LEDs.

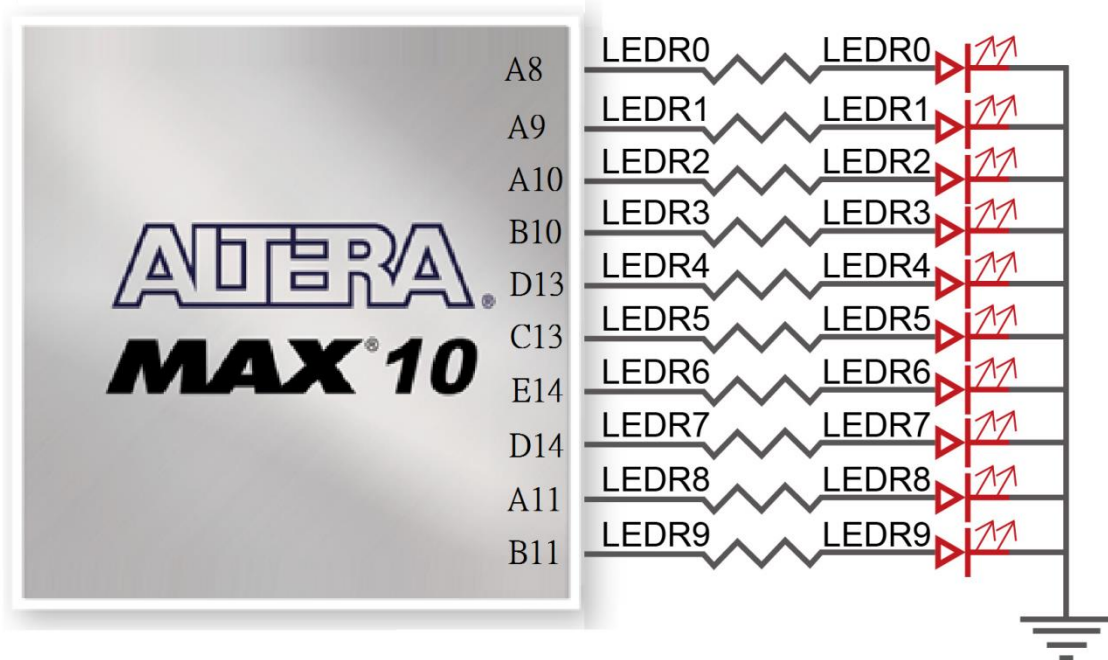

Figure 3-16 Connections between the LEDs and MAX 10 FPGA

Table 3-5 Pin Assignment of LEDs

Signal Name	FPGA Pin No.	Description	I/O Standard
LEDR0	PIN_A8	LED [0]	3.3-V LVTTTL
LEDR1	PIN_A9	LED [1]	3.3-V LVTTTL
LEDR2	PIN_A10	LED [2]	3.3-V LVTTTL
LEDR3	PIN_B10	LED [3]	3.3-V LVTTTL
LEDR4	PIN_D13	LED [4]	3.3-V LVTTTL
LEDR5	PIN_C13	LED [5]	3.3-V LVTTTL
LEDR6	PIN_E14	LED [6]	3.3-V LVTTTL
LEDR7	PIN_D14	LED [7]	3.3-V LVTTTL
LEDR8	PIN_A11	LED [8]	3.3-V LVTTTL
LEDR9	PIN_B11	LED [9]	3.3-V LVTTTL

3.4 Using the 7-segment Displays

The DE10-Lite board has six 7-segment displays to display numbers. **Figure 3-17** shows the connection of seven segments (common anode) to pins on MAX 10 FPGA. The segment can be turned on or off by applying a low logic level or high logic level from the FPGA, respectively.

Each segment in a display is indexed from 0 to 6 and DP (decimal point), with corresponding positions given in **Figure 3-17**. **Table 3-6** shows the pin assignment of FPGA to the 7-segment displays.

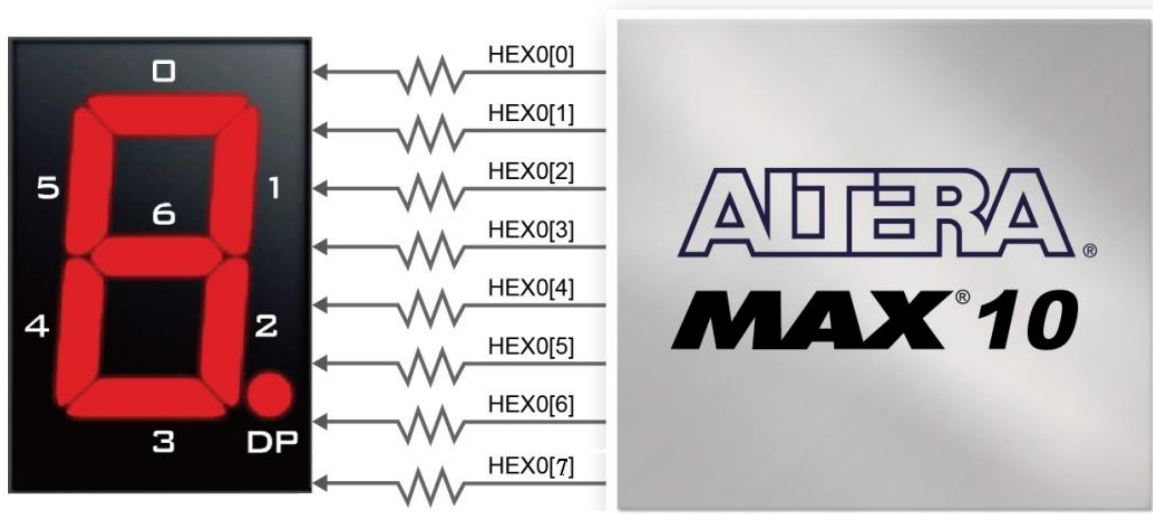

Figure 3-17 Connections between the 7-segment display HEX0 and the MAX 10 FPGA

Table 3-6 Pin Assignment of 7-segment Displays

Signal Name	FPGA Pin No.	Description	I/O Standard
HEX00	PIN_C14	Seven Segment Digit 0[0]	3.3-V LVTTTL
HEX01	PIN_E15	Seven Segment Digit 0[1]	3.3-V LVTTTL
HEX02	PIN_C15	Seven Segment Digit 0[2]	3.3-V LVTTTL
HEX03	PIN_C16	Seven Segment Digit 0[3]	3.3-V LVTTTL
HEX04	PIN_E16	Seven Segment Digit 0[4]	3.3-V LVTTTL
HEX05	PIN_D17	Seven Segment Digit 0[5]	3.3-V LVTTTL
HEX06	PIN_C17	Seven Segment Digit 0[6]	3.3-V LVTTTL
HEX07	PIN_D15	Seven Segment Digit 0[7], DP	3.3-V LVTTTL
HEX10	PIN_C18	Seven Segment Digit 1[0]	3.3-V LVTTTL
HEX11	PIN_D18	Seven Segment Digit 1[1]	3.3-V LVTTTL
HEX12	PIN_E18	Seven Segment Digit 1[2]	3.3-V LVTTTL
HEX13	PIN_B16	Seven Segment Digit 1[3]	3.3-V LVTTTL

HEX14	PIN_A17	Seven Segment Digit 1[4]	3.3-V LVTTTL
HEX15	PIN_A18	Seven Segment Digit 1[5]	3.3-V LVTTTL
HEX16	PIN_B17	Seven Segment Digit 1[6]	3.3-V LVTTTL
HEX17	PIN_A16	Seven Segment Digit 1[7] , DP	3.3-V LVTTTL
HEX20	PIN_B20	Seven Segment Digit 2[0]	3.3-V LVTTTL
HEX21	PIN_A20	Seven Segment Digit 2[1]	3.3-V LVTTTL
HEX22	PIN_B19	Seven Segment Digit 2[2]	3.3-V LVTTTL
HEX23	PIN_A21	Seven Segment Digit 2[3]	3.3-V LVTTTL
HEX24	PIN_B21	Seven Segment Digit 2[4]	3.3-V LVTTTL
HEX25	PIN_C22	Seven Segment Digit 2[5]	3.3-V LVTTTL
HEX26	PIN_B22	Seven Segment Digit 2[6]	3.3-V LVTTTL
HEX27	PIN_A19	Seven Segment Digit 2[7] , DP	3.3-V LVTTTL
HEX30	PIN_F21	Seven Segment Digit 3[0]	3.3-V LVTTTL
HEX31	PIN_E22	Seven Segment Digit 3[1]	3.3-V LVTTTL
HEX32	PIN_E21	Seven Segment Digit 3[2]	3.3-V LVTTTL
HEX33	PIN_C19	Seven Segment Digit 3[3]	3.3-V LVTTTL
HEX34	PIN_C20	Seven Segment Digit 3[4]	3.3-V LVTTTL
HEX35	PIN_D19	Seven Segment Digit 3[5]	3.3-V LVTTTL
HEX36	PIN_E17	Seven Segment Digit 3[6]	3.3-V LVTTTL
HEX37	PIN_D22	Seven Segment Digit 3[7] , DP	3.3-V LVTTTL
HEX40	PIN_F18	Seven Segment Digit 4[0]	3.3-V LVTTTL
HEX41	PIN_E20	Seven Segment Digit 4[1]	3.3-V LVTTTL
HEX42	PIN_E19	Seven Segment Digit 4[2]	3.3-V LVTTTL
HEX43	PIN_J18	Seven Segment Digit 4[3]	3.3-V LVTTTL
HEX44	PIN_H19	Seven Segment Digit 4[4]	3.3-V LVTTTL
HEX45	PIN_F19	Seven Segment Digit 4[5]	3.3-V LVTTTL
HEX46	PIN_F20	Seven Segment Digit 4[6]	3.3-V LVTTTL
HEX47	PIN_F17	Seven Segment Digit 4[7] , DP	3.3-V LVTTTL
HEX50	PIN_J20	Seven Segment Digit 5[0]	3.3-V LVTTTL
HEX51	PIN_K20	Seven Segment Digit 5[1]	3.3-V LVTTTL
HEX52	PIN_L18	Seven Segment Digit 5[2]	3.3-V LVTTTL
HEX53	PIN_N18	Seven Segment Digit 5[3]	3.3-V LVTTTL
HEX54	PIN_M20	Seven Segment Digit 5[4]	3.3-V LVTTTL
HEX55	PIN_N19	Seven Segment Digit 5[5]	3.3-V LVTTTL
HEX56	PIN_N20	Seven Segment Digit 5[6]	3.3-V LVTTTL
HEX57	PIN_L19	Seven Segment Digit 5[7] , DP	3.3-V LVTTTL

3.5 Using 2x20 GPIO Expansion Headers

The board has one 40-pin expansion headers. Each header has 36 user pins connected directly to the MAX 10 FPGA. It also comes with DC +5V (VCC5), DC +3.3V (VCC3P3), and two GND pins. Both 5V and 3.3V can provide a total of 5W power.

Figure 3-18 shows the related schematics. Table 3-7 shows the pin assignment of GPIO headers.

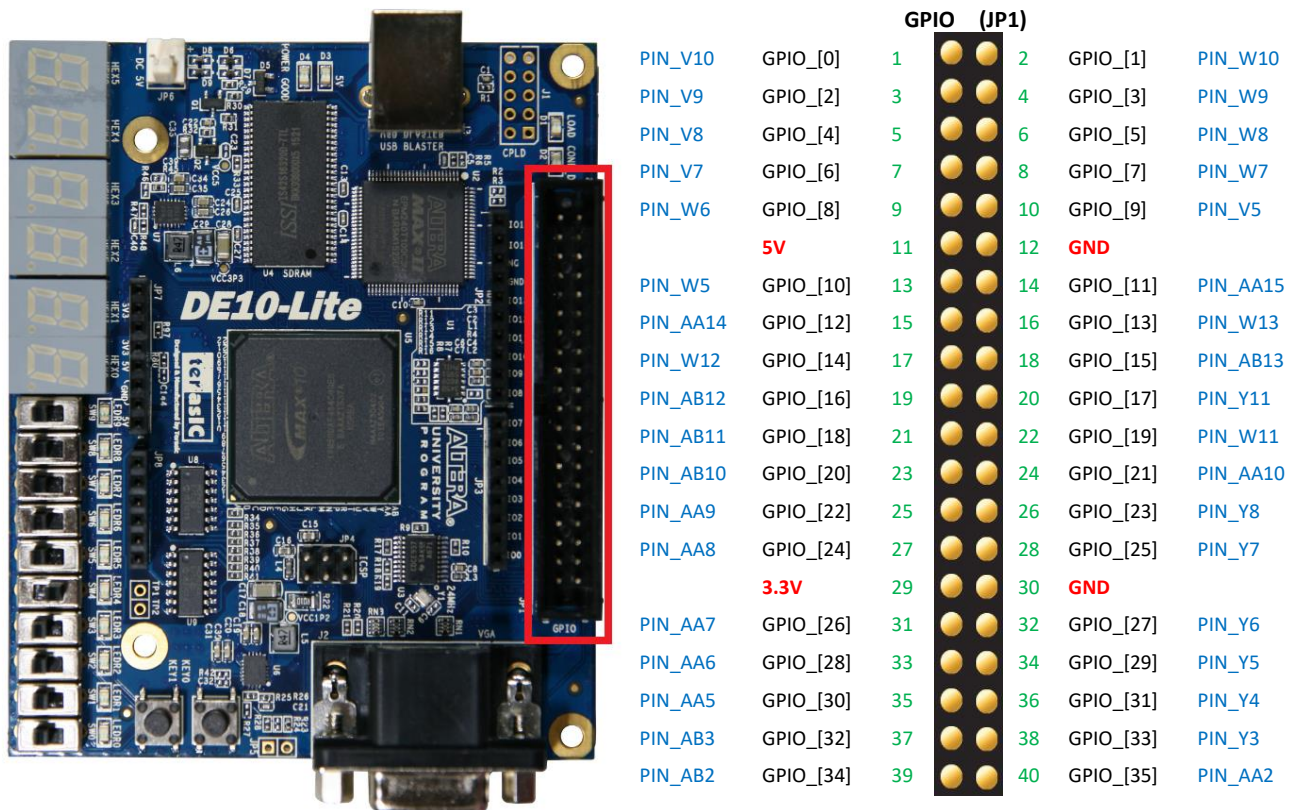

Figure 3-18 I/O distribution of the expansion headers

Table 3-7 Show all Pin Assignment of Expansion Headers

Signal Name	FPGA Pin No.	Description	I/O Standard
GPIO_0	PIN_V10	GPIO Connection [0]	3.3-V LVTTTL
GPIO_1	PIN_W10	GPIO Connection [1]	3.3-V LVTTTL
GPIO_2	PIN_V9	GPIO Connection [2]	3.3-V LVTTTL
GPIO_3	PIN_W9	GPIO Connection [3]	3.3-V LVTTTL
GPIO_4	PIN_V8	GPIO Connection [4]	3.3-V LVTTTL
GPIO_5	PIN_W8	GPIO Connection [5]	3.3-V LVTTTL
GPIO_6	PIN_V7	GPIO Connection [6]	3.3-V LVTTTL
GPIO_7	PIN_W7	GPIO Connection [7]	3.3-V LVTTTL
GPIO_8	PIN_W6	GPIO Connection [8]	3.3-V LVTTTL
GPIO_9	PIN_V5	GPIO Connection [9]	3.3-V LVTTTL
GPIO_10	PIN_W5	GPIO Connection [10]	3.3-V LVTTTL
GPIO_11	PIN_AA15	GPIO Connection [11]	3.3-V LVTTTL
GPIO_12	PIN_AA14	GPIO Connection [12]	3.3-V LVTTTL
GPIO_13	PIN_W13	GPIO Connection [13]	3.3-V LVTTTL
GPIO_14	PIN_W12	GPIO Connection [14]	3.3-V LVTTTL
GPIO_15	PIN_AB13	GPIO Connection [15]	3.3-V LVTTTL
GPIO_16	PIN_AB12	GPIO Connection [16]	3.3-V LVTTTL
GPIO_17	PIN_Y11	GPIO Connection [17]	3.3-V LVTTTL
GPIO_18	PIN_AB11	GPIO Connection [18]	3.3-V LVTTTL
GPIO_19	PIN_W11	GPIO Connection [19]	3.3-V LVTTTL
GPIO_20	PIN_AB10	GPIO Connection [20]	3.3-V LVTTTL
GPIO_21	PIN_AA10	GPIO Connection [21]	3.3-V LVTTTL
GPIO_22	PIN_AA9	GPIO Connection [22]	3.3-V LVTTTL
GPIO_23	PIN_Y8	GPIO Connection [23]	3.3-V LVTTTL
GPIO_24	PIN_AA8	GPIO Connection [24]	3.3-V LVTTTL
GPIO_25	PIN_Y7	GPIO Connection [25]	3.3-V LVTTTL
GPIO_26	PIN_AA7	GPIO Connection [26]	3.3-V LVTTTL
GPIO_27	PIN_Y6	GPIO Connection [27]	3.3-V LVTTTL
GPIO_28	PIN_AA6	GPIO Connection [28]	3.3-V LVTTTL
GPIO_29	PIN_Y5	GPIO Connection [29]	3.3-V LVTTTL
GPIO_30	PIN_AA5	GPIO Connection [30]	3.3-V LVTTTL
GPIO_31	PIN_Y4	GPIO Connection [31]	3.3-V LVTTTL
GPIO_32	PIN_AB3	GPIO Connection [32]	3.3-V LVTTTL
GPIO_33	PIN_Y3	GPIO Connection [33]	3.3-V LVTTTL
GPIO_34	PIN_AB2	GPIO Connection [34]	3.3-V LVTTTL
GPIO_35	PIN_AA2	GPIO Connection [35]	3.3-V LVTTTL

3.6 Using Arduino Uno R3 Expansion Header

The board provides Arduino Uno revision 3 compatibility expansion header which comes with four independent headers. The expansion header has 17 user pins (16pins GPIO and 1pin Reset) connected directly to the MAX 10 FPGA. 6-pins Analog input connects to ADC, and also provides DC +5V (VCC5), DC +3.3V (VCC3P3 and IOREF), and three GND pins.

Please refer to **Figure 3-19** for detailed pin-out information. The blue font represents the Arduino Uno R3 board pin-out definition.

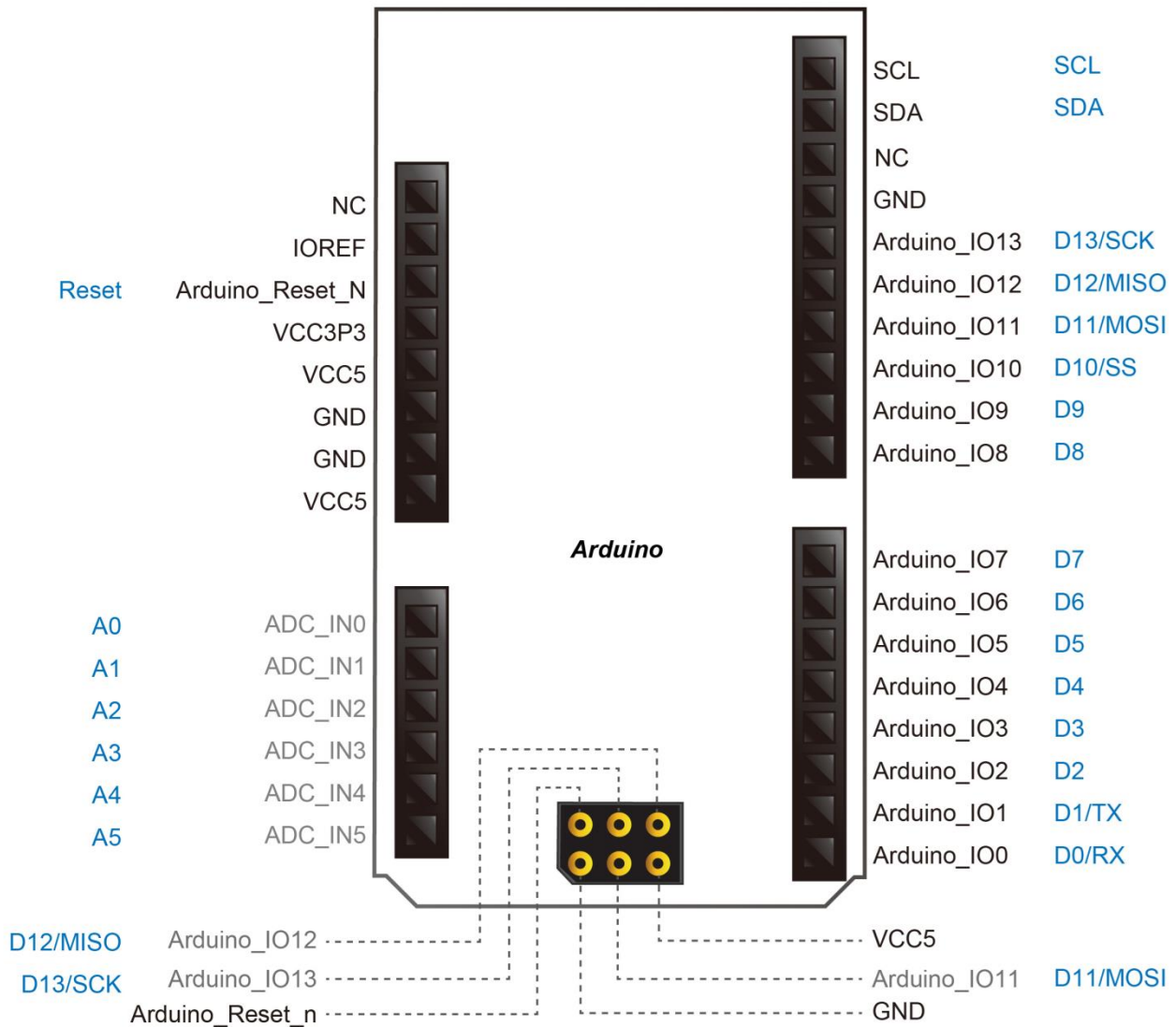

Figure 3-19 lists the all the pin-out signal name of the Arduino Uno connector. The blue font represents the Arduino pin-out definition.

The 16 GPIO pins are provided to the Arduino Header for digital I/O. **Table 3-8** lists the all the pin assignments of the Arduino Uno connector (digital), signal names relative to the MAX 10 FPGA.

Table 3-8 Pin Assignments for Arduino Uno Expansion Header connector

Schematic Signal Name	FPGA Pin No.	Description	Specific features For Arduino	I/O Standard
Arduino_IO0	PIN_AB5	Arduino IO0	RXD	3.3-V LVTTTL
Arduino_IO1	PIN_AB6	Arduino IO1	TXD	3.3-V LVTTTL
Arduino_IO2	PIN_AB7	Arduino IO2		3.3-V LVTTTL
Arduino_IO3	PIN_AB8	Arduino IO3		3.3-V LVTTTL
Arduino_IO4	PIN_AB9	Arduino IO4		3.3-V LVTTTL
Arduino_IO5	PIN_Y10	Arduino IO5		3.3-V LVTTTL
Arduino_IO6	PIN_AA11	Arduino IO6		3.3-V LVTTTL
Arduino_IO7	PIN_AA12	Arduino IO7		3.3-V LVTTTL
Arduino_IO8	PIN_AB17	Arduino IO8		3.3-V LVTTTL
Arduino_IO9	PIN_AA17	Arduino IO9		3.3-V LVTTTL
Arduino_IO10	PIN_AB19	Arduino IO10	SS	3.3-V LVTTTL
Arduino_IO11	PIN_AA19	Arduino IO11	MOSI	3.3-V LVTTTL
Arduino_IO12	PIN_Y19	Arduino IO12	MISO	3.3-V LVTTTL
Arduino_IO13	PIN_AB20	Arduino IO13	SCK	3.3-V LVTTTL
Arduino_IO14	PIN_AB21	Arduino IO14	SDA	3.3-V LVTTTL
Arduino_IO15	PIN_AA20	Arduino IO15	SCL	3.3-V LVTTTL
ARDUINO_RESET_N	PIN_F16	Reset signal, low active.		3.3 V SCHMITT TRIGGER"

Besides 16 pins for digital GPIO, there are also 6 analog inputs on the Arduino Uno R3 Expansion Header (ADC_IN0 ~ ADC_IN5). Consequently, we use MAX 10 FPGA ADC on the board for possible future analog-to-digital applications. We will introduce in the next section.

3.7 A/D Converter and Analog Input

The DE10-Lite board has eight analog inputs are connected to MAX 10 FPGA ADC1, through a 1x6 and a 1x2 header input, wherein the 1x2 header is reserved and not mounted with parts.

Any analog inputs signals sourced through the Arduino header JP8 are first filtered by the Analog Front-End circuit. This circuit scales the maximum allowable voltage per the Arduino specification (5.0V) to the maximum allowable voltage per the MAX 10 FPGA ADC IP block (2.5V).

These Analog inputs are shared with the Arduino's analog input pin (ADC_IN0 ~ ADC_IN5), **Figure 3-20** shows the connections between the Arduino Analog input and FPGA.

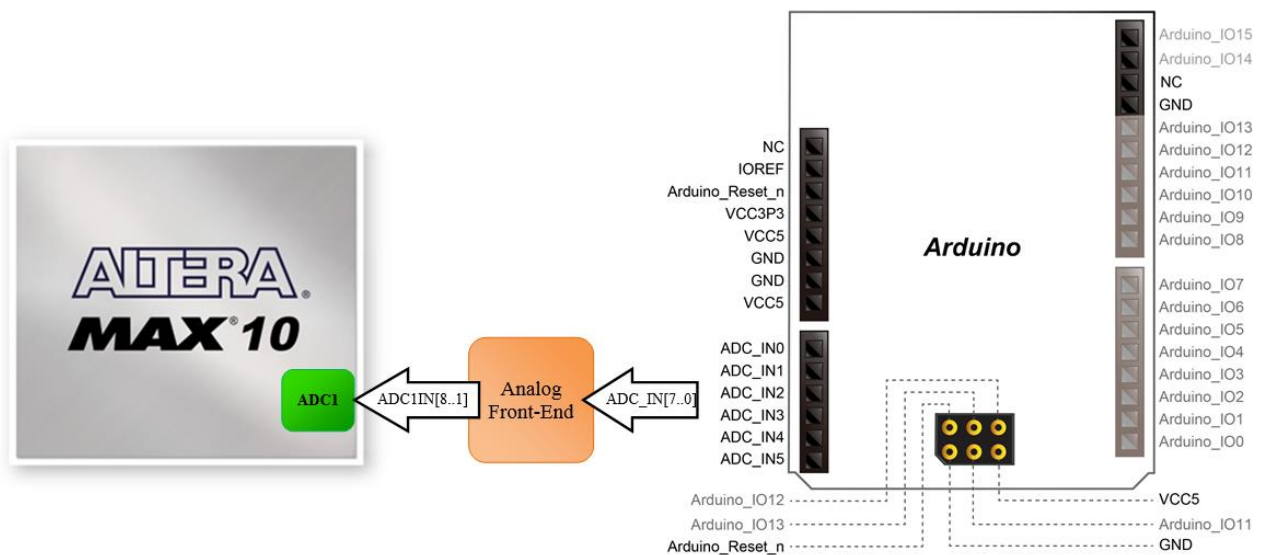

Figure 3-20 Connections between the Arduino Analog input and MAX 10 FPGA

3. 8 Using VGA

The DE10-Lite board includes a 15-pin D-SUB connector for VGA output. The VGA synchronization signals are provided directly from the MAX 10 FPGA, and a 4-bit DAC using resistor network is used to produce the analog data signals (red, green, and blue). The associated schematic is given in **Figure 3-21** and can support standard VGA resolution (640x480 pixels, at 25 MHz).

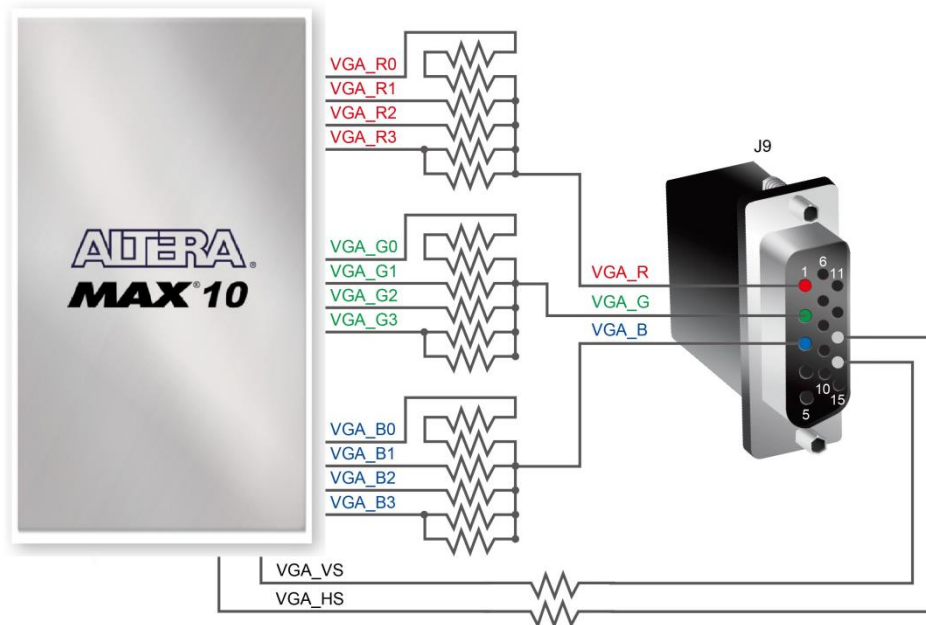

Figure 3-21 Connections between the VGA and MAX 10 FPGA

The timing specification for VGA synchronization and RGB (red, green, blue) data can be easily found on website nowadays. **Figure 3-21** illustrates the basic timing requirements for each row (horizontal) displayed on a VGA monitor. An active-low pulse of specific duration is applied to the horizontal synchronization (hsync) input of the monitor, which signifies the end of one row of data and the start of the next. The data (RGB) output to the monitor must be off (driven to 0 V) for a time period called the back porch (b) after the hsync pulse occurs, which is followed by the display interval (c). During the data display interval the RGB data drives each pixel in turn across the row being displayed. Finally, there is a time period called the front porch (d) where the RGB signals must again be off before the next hsync pulse can occur. The timing of vertical synchronization (vsync) is similar to the one shown in **Figure 3-22**, except that a vsync pulse signifies the end of one frame and the start of the next, and the data refers to the set of rows in the frame (horizontal timing). **Table 3-9** and **Table 3-10** show different resolutions and durations of time period a, b, c, and d for both horizontal and vertical timing.

The pin assignments between the MAX 10 FPGA and the VGA connector are listed in **Table 3-11**.

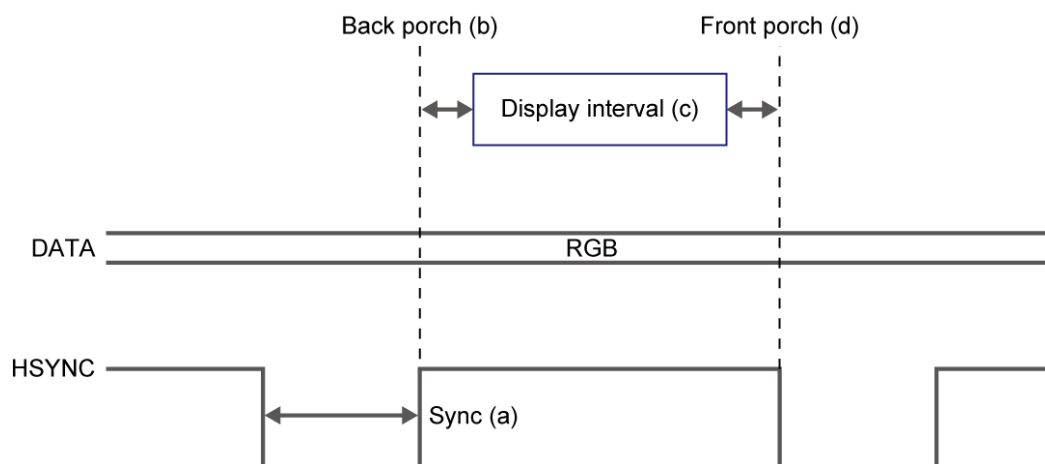

Figure 3-22 VGA horizontal timing specification

Table 3-9 VGA Horizontal Timing Specification

VGA mode		Horizontal Timing Spec				
Configuration	Resolution(HxV)	a(pixel clock cycle)	b(pixel clock cycle)	c(pixel clock cycle)	d(pixel clock cycle)	Pixel clock(MHz)
VGA(60Hz)	640x480	96	48	640	16	25

Table 3-10 VGA Vertical Timing Specification

VGA mode		Vertical Timing Spec				
Configuration	Resolution(HxV)	a(lines)	b(lines)	c(lines)	d(lines)	Pixel clock(MHz)
VGA(60Hz)	640x480	2	33	480	10	25

Table 3-11 Pin Assignment of VGA

Signal Name	FPGA Pin No.	Description	I/O Standard
VGA_R0	PIN_AA1	VGA Red[0]	3.3-V LVTTTL
VGA_R1	PIN_V1	VGA Red[1]	3.3-V LVTTTL
VGA_R2	PIN_Y2	VGA Red[2]	3.3-V LVTTTL
VGA_R3	PIN_Y1	VGA Red[3]	3.3-V LVTTTL
VGA_G0	PIN_W1	VGA Green[0]	3.3-V LVTTTL
VGA_G1	PIN_T2	VGA Green[1]	3.3-V LVTTTL
VGA_G2	PIN_R2	VGA Green[2]	3.3-V LVTTTL
VGA_G3	PIN_R1	VGA Green[3]	3.3-V LVTTTL
VGA_B0	PIN_P1	VGA Blue[0]	3.3-V LVTTTL
VGA_B1	PIN_T1	VGA Blue[1]	3.3-V LVTTTL
VGA_B2	PIN_P4	VGA Blue[2]	3.3-V LVTTTL
VGA_B3	PIN_N2	VGA Blue[3]	3.3-V LVTTTL
VGA_HS	PIN_N3	VGA Horizontal sync	3.3-V LVTTTL
VGA_VS	PIN_N1	VGA Vertical sync	3.3-V LVTTTL

3.9 Using SDRAM

The board features 64MB of SDRAM with a single 64MB (32Mx16) SDRAM chip. The chip consists of 16-bit data line, control line, and address line connected to the FPGA. This chip uses the 3.3V LVCMOS signaling standard. Connections between the FPGA and SDRAM are shown in **Figure 3-23**, and the pin assignment is listed in **Table 3-12**. Detailed information on using the SDRAM is available on the manufacturer’s website, or under the `\Datasheets\SDRAM` folder on the DE10-Lite System CD.

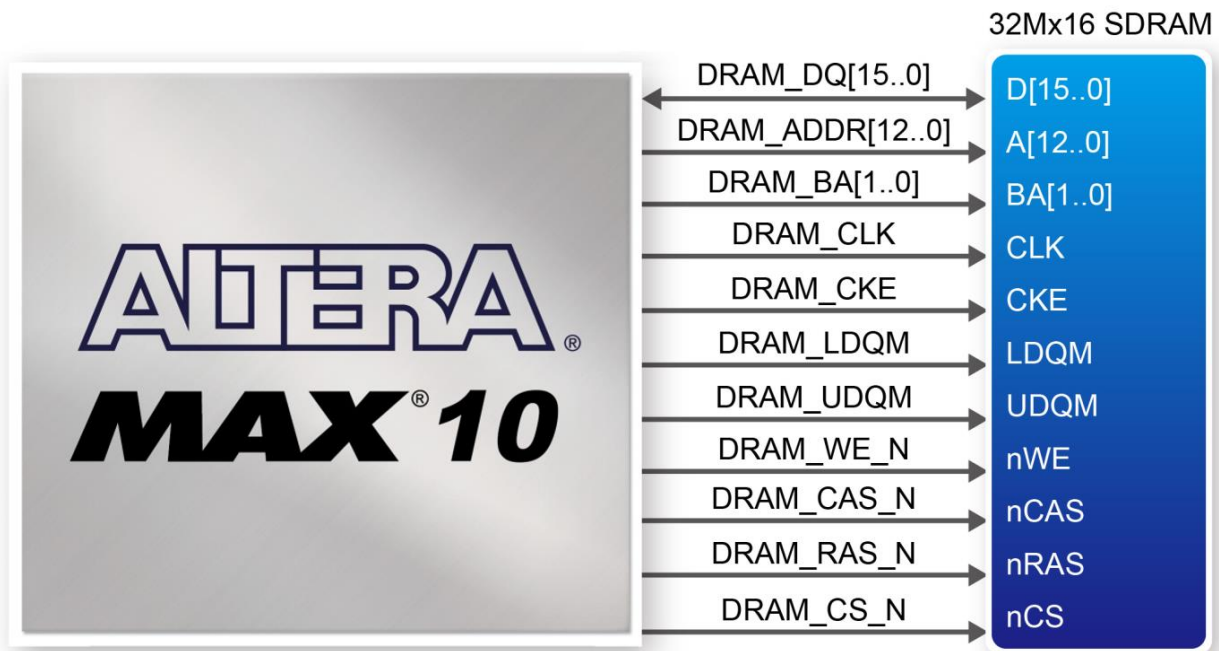

Figure 3-23 Connections between the SDRAM and MAX 10 FPGA

Table 3-12 Pin Assignment of SDRAM

Signal Name	FPGA Pin No.	Description	I/O Standard
DRAM_ADDR0	PIN_U17	SDRAM Address[0]	3.3-V LVTTTL
DRAM_ADDR1	PIN_W19	SDRAM Address[1]	3.3-V LVTTTL
DRAM_ADDR2	PIN_V18	SDRAM Address[2]	3.3-V LVTTTL
DRAM_ADDR3	PIN_U18	SDRAM Address[3]	3.3-V LVTTTL
DRAM_ADDR4	PIN_U19	SDRAM Address[4]	3.3-V LVTTTL
DRAM_ADDR5	PIN_T18	SDRAM Address[5]	3.3-V LVTTTL
DRAM_ADDR6	PIN_T19	SDRAM Address[6]	3.3-V LVTTTL
DRAM_ADDR7	PIN_R18	SDRAM Address[7]	3.3-V LVTTTL
DRAM_ADDR8	PIN_P18	SDRAM Address[8]	3.3-V LVTTTL
DRAM_ADDR9	PIN_P19	SDRAM Address[9]	3.3-V LVTTTL
DRAM_ADDR10	PIN_T20	SDRAM Address[10]	3.3-V LVTTTL
DRAM_ADDR11	PIN_P20	SDRAM Address[11]	3.3-V LVTTTL
DRAM_ADDR12	PIN_R20	SDRAM Address[12]	3.3-V LVTTTL
DRAM_DQ0	PIN_Y21	SDRAM Data[0]	3.3-V LVTTTL
DRAM_DQ1	PIN_Y20	SDRAM Data[1]	3.3-V LVTTTL
DRAM_DQ2	PIN_AA22	SDRAM Data[2]	3.3-V LVTTTL
DRAM_DQ3	PIN_AA21	SDRAM Data[3]	3.3-V LVTTTL
DRAM_DQ4	PIN_Y22	SDRAM Data[4]	3.3-V LVTTTL
DRAM_DQ5	PIN_W22	SDRAM Data[5]	3.3-V LVTTTL
DRAM_DQ6	PIN_W20	SDRAM Data[6]	3.3-V LVTTTL
DRAM_DQ7	PIN_V21	SDRAM Data[7]	3.3-V LVTTTL
DRAM_DQ8	PIN_P21	SDRAM Data[8]	3.3-V LVTTTL
DRAM_DQ9	PIN_J22	SDRAM Data[9]	3.3-V LVTTTL
DRAM_DQ10	PIN_H21	SDRAM Data[10]	3.3-V LVTTTL
DRAM_DQ11	PIN_H22	SDRAM Data[11]	3.3-V LVTTTL
DRAM_DQ12	PIN_G22	SDRAM Data[12]	3.3-V LVTTTL
DRAM_DQ13	PIN_G20	SDRAM Data[13]	3.3-V LVTTTL
DRAM_DQ14	PIN_G19	SDRAM Data[14]	3.3-V LVTTTL
DRAM_DQ15	PIN_F22	SDRAM Data[15]	3.3-V LVTTTL
DRAM_BA0	PIN_T21	SDRAM Bank Address[0]	3.3-V LVTTTL
DRAM_BA1	PIN_T22	SDRAM Bank Address[1]	3.3-V LVTTTL
DRAM_LDQM	PIN_V22	SDRAM byte Data Mask[0]	3.3-V LVTTTL
DRAM_UDQM	PIN_J21	SDRAM byte Data Mask[1]	3.3-V LVTTTL
DRAM_RAS_N	PIN_U22	SDRAM Row Address Strobe	3.3-V LVTTTL
DRAM_CAS_N	PIN_U21	SDRAM Column Address Strobe	3.3-V LVTTTL
DRAM_CKE	PIN_N22	SDRAM Clock Enable	3.3-V LVTTTL
DRAM_CLK	PIN_L14	SDRAM Clock	3.3-V LVTTTL
DRAM_WE_N	PIN_V20	SDRAM Write Enable	3.3-V LVTTTL
DRAM_CS_N	PIN_U20	SDRAM Chip Select	3.3-V LVTTTL

3. 10 Using Accelerometer Sensor

The board comes with a digital accelerometer sensor module (ADXL345), commonly known as G-sensor. This G-sensor is a small, thin, ultralow power assumption 3-axis accelerometer with high-resolution measurement. Digitalized output is formatted as 16-bit in two's complement and can be accessed through SPI (3- and 4-wire) and I2C digital interfaces.

With GSENSOR_CS_N signal to high, the ADXL345 is in I2C mode. With the GSENSOR_SDO signal to high, the 7-bit I2C address for the device is 0x1D, followed by the R/W bit. This translates to 0x3A for a write and 0x3B for a read. An alternate I2C address of 0x53 (followed by the R/W bit) can be chosen by low the GSENSOR_SDO signal. This translates to 0xA6 for a write and 0xA7 for a read.

More information about this chip can be found in its datasheet, which is available on manufacturer's website or in the directory `\Datasheet\G-Sensor` folder of DE10-Lite system CD.

Figure 3-24 shows the connections between the accelerometer sensor and MAX 10 FPGA. **Table 3-13** lists the pin assignment of accelerometer to the MAX 10 FPGA.

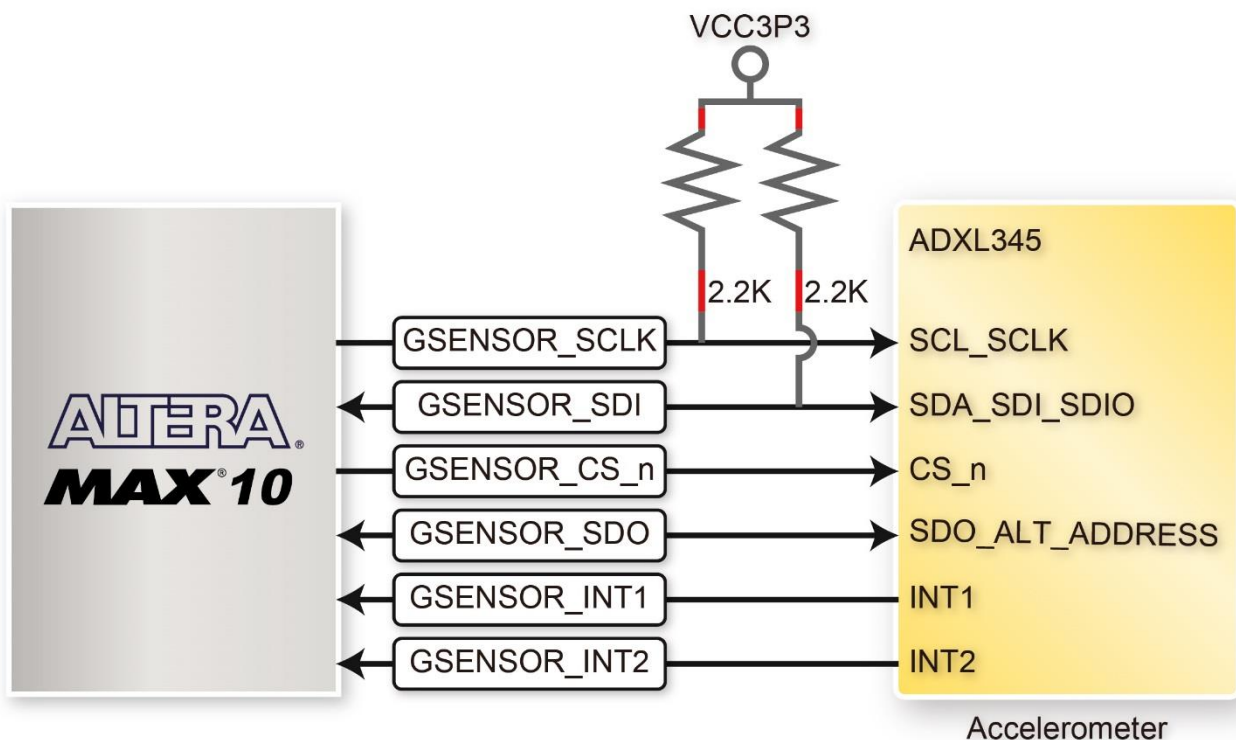

Figure 3-24 shows the connections between the accelerometer sensor and MAX 10 FPGA.

Table 3-13 Pin Assignment of Accelerometer Sensor

Signal Name	FPGA Pin No.	Description	I/O Standard
GSENSOR_SDI	PIN_V11	I2C serial data SPI serial data input (SPI 4-wire) SPI serial data input and output (SPI 3-wire)	3.3-V LVTTTL
GSENSOR_SDO	PIN_V12	SPI serial data output (SPI 4-wire) Alternate I2C address select	3.3-V LVTTTL
GSENSOR_CS_n	PIN_AB16	I2C/SPI mode selection: 1: SPI idle mode / I2C communication enabled 0: SPI communication mode / I2C disabled SPI Chip Select	3.3-V LVTTTL
GSENSOR_SCLK	PIN_AB15	I2C serial clock SPI serial clock (3- and 4-wire)	3.3-V LVTTTL
GSENSOR_INT1	PIN_Y14	Interrupt pin 1	3.3-V LVTTTL
GSENSOR_INT2	PIN_Y13	Interrupt pin 2	3.3-V LVTTTL

DE10-Lite System Builder

This chapter describes how users can create a custom design project with the tool named DE10-Lite System Builder.

4. 1 Introduction

The DE10-Lite System Builder is a Windows-based utility. It is designed to help users create a Quartus II project for DE10-Lite within minutes. The generated Quartus II project files include:

Quartus II project file (.qpf)

Quartus II setting file (.qsf)

Top-level design file (.v)

Synopsis design constraints file (.sdc)

Pin assignment document (.htm)

The above files generated by the DE10-Lite System Builder can also prevent occurrence of situations that are prone to compilation error when users manually edit the top-level design file or place pin assignment. The common mistakes that users encounter are:

Board is damaged due to incorrect bank voltage setting or pin assignment.

Board is malfunctioned because of wrong device chosen, declaration of pin location or direction is incorrect or forgotten.

Performance degradation due to improper pin assignment.

4.2 General Design Flow

This section provides an introduction to the design flow of building a Quartus II project for DE10-Lite under the DE10-Lite System Builder. The design flow is illustrated in **Figure 4-1**.

The DE10-Lite System Builder will generate two major files, a top-level design file (.v) and a Quartus II setting file (.qsf) after users launch the DE10-Lite System Builder and create a new project according to their design requirements.

The top-level design file contains a top-level Verilog HDL wrapper for users to add their own design/logic. The Quartus II setting file contains information such as FPGA device type, top-level pin assignment, and the I/O standard for each user-defined I/O pin.

Finally, the Quartus II programmer is used to download .sof file to the development board via JTAG interface.

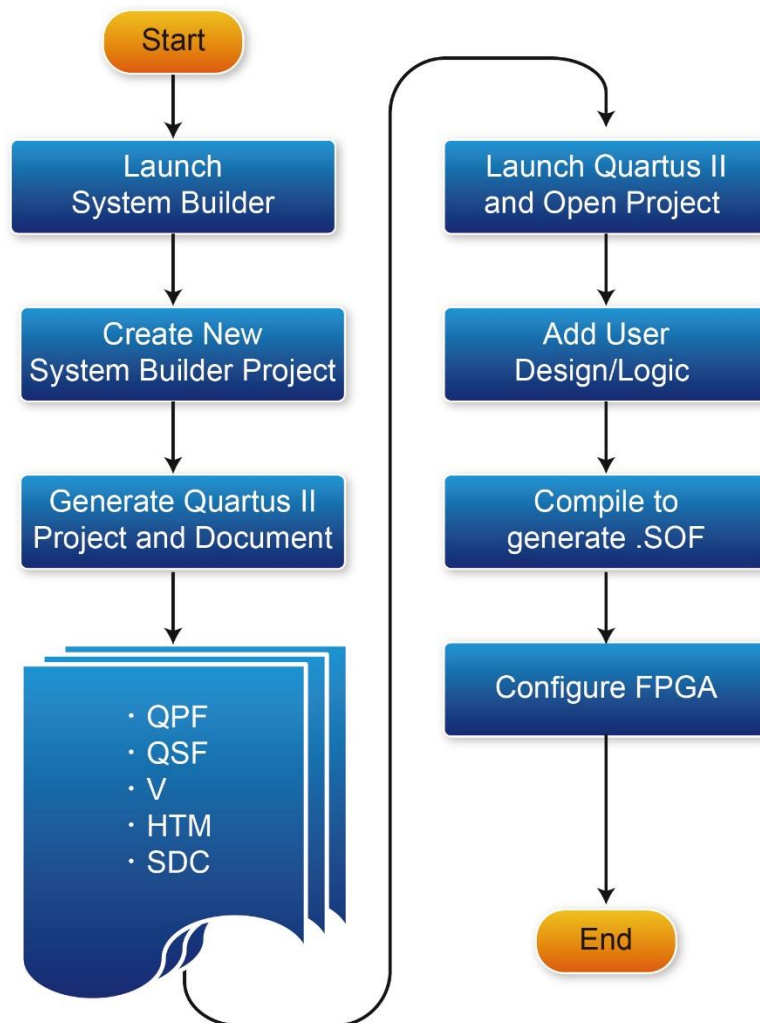

Figure 4-1 Design flow of building a project from the beginning to the end

4.3 Using DE10-Lite System Builder

This section provides the procedures in details on how to use the DE10-Lite System Builder.

■ Install and Launch the DE10-Lite System Builder

The DE10-Lite System Builder is located in the directory: “Tools\SystemBuilder” of the DE10-Lite System CD. Users can copy the entire folder to a host computer without installing the utility. A window will pop up, as shown in **Figure 4-2**, after executing the DE10-Lite SystemBuilder.exe on the host computer.

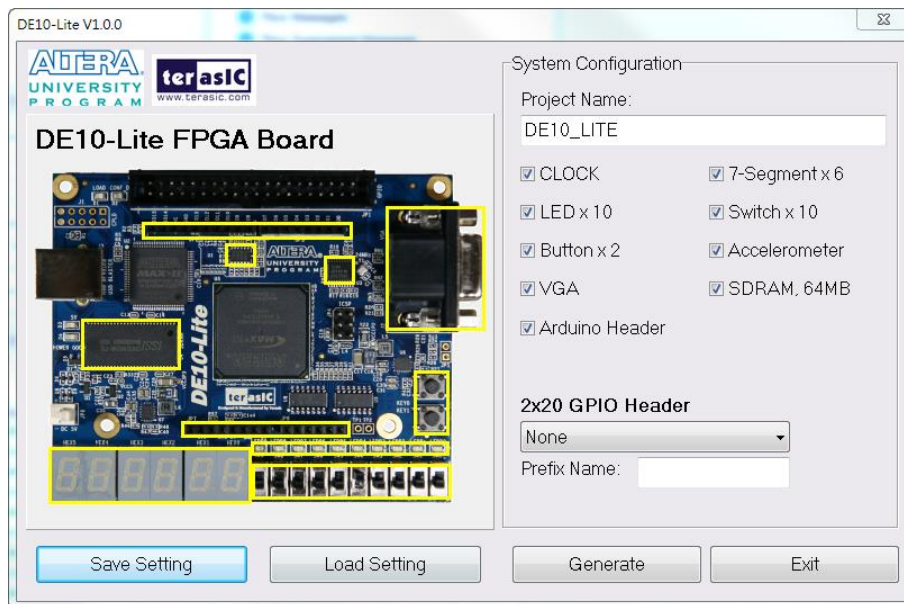

Figure 4-2 The GUI of DE10-Lite System Builder

■ Enter Project Name

Enter the project name in the circled area, as shown in **Figure 4-3**.

The project name typed in will be assigned automatically as the name of your top-level design entity.

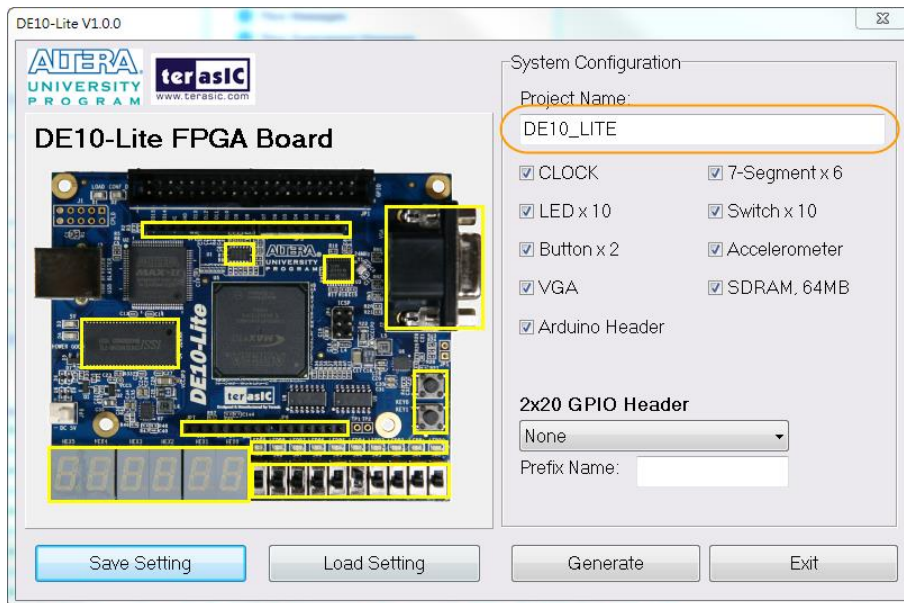

Figure 4-3 Enter the project name

■ System Configuration

Users are given the flexibility in the System Configuration to include their choice of components in the project, as shown in **Figure 4-4**. Each component onboard is listed and users can enable or disable one or more components at will. If a component is enabled, the DE10-Lite System Builder will automatically generate its associated pin assignment, including the pin name, pin location, pin direction, and I/O standard.

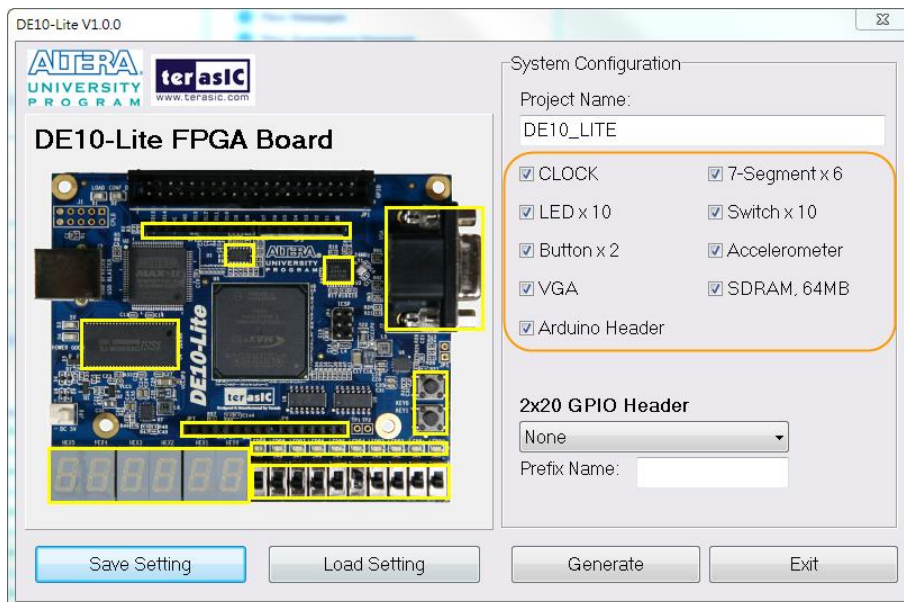

Figure 4-4 System configuration group

■ GPIO Expansion

If users connect any Terasic GPIO-based daughter card to the GPIO connector(s) on DE10-Lite, the DE10-Lite System Builder can generate a project that include the corresponding module, as shown in **Figure 4-5**. It will also generate the associated pin assignment automatically, including pin name, pin location, pin direction, and I/O standard.

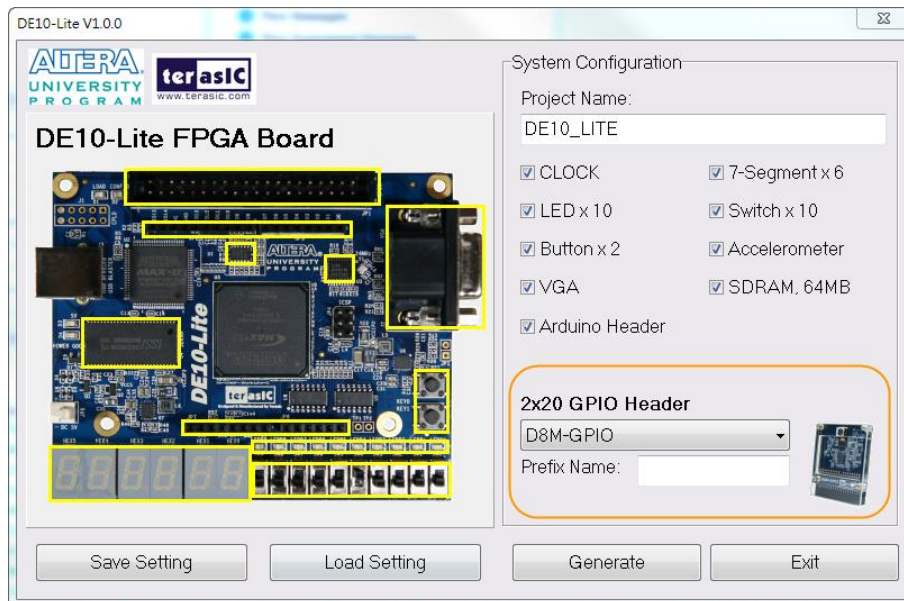

Figure 4-5 GPIO expansion group

The “Prefix Name” is an optional feature that denote the pin name of the daughter card assigned in your design. Users may leave this field blank.

■ Project Setting Management

The DE10-Lite System Builder also provides the option to load a setting or save users' current board configuration in .cfg file, as shown in **Figure 4-6**.

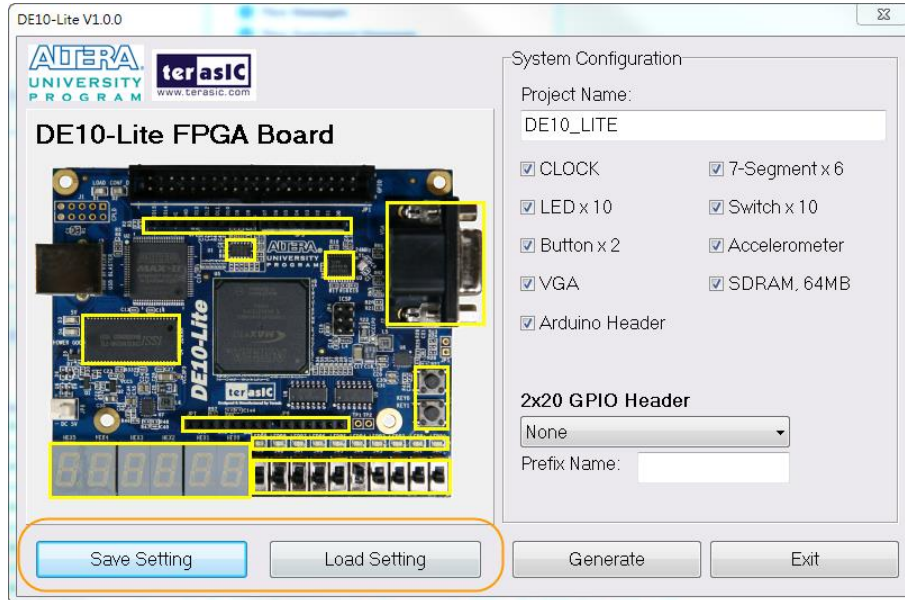

Figure 4-6 Project Settings

■ Project Generation

When users press the *Generate* button as shown in **Figure 4-7**, the DE10-Lite System Builder will generate the corresponding Quartus II files and documents, as listed in **Table 4-1**:

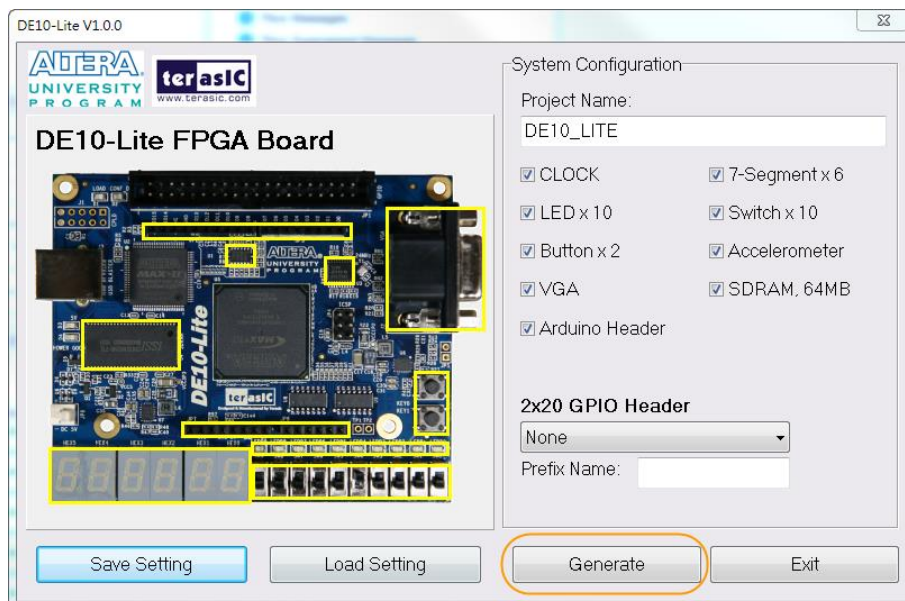

Figure 4-7 Generate Quartus Project

Table 4-1 Files generated by the DE10-Lite System Builder

No.	Filename	Description
1	<Project name>.v	Top level Verilog HDL file for Quartus II
2	<Project name>.qpf	Quartus II Project File
3	<Project name>.qsf	Quartus II Setting File
4	<Project name>.sdc	Synopsis Design Constraints file for Quartus II
5	<Project name>.htm	Pin Assignment Document

Users can add custom logic into the project in Quartus II and compile the project to generate the SRAM Object File (.sof).

Chapter 5

Examples of Advanced Demonstrations

This chapter provides examples of advanced designs implemented by RTL or Qsys on the DE10-Lite board. These reference designs cover the features of peripherals connected to the FPGA, such as VGA, SDRAM, and Accelerometer Sensor. All the associated files can be found in the directory \Demonstrations of DE10-Lite System CD.

■ Installation of Demonstrations

To install the demonstrations on your computer:

Copy the folder Demonstrations to a local directory of your choice. It is important to make sure the path to your local directory contains NO space. Otherwise, it will lead to error in Nios II.

Note : Quartus II v16.0 or later is required for all DE10-Lite demonstrations to support MAX 10 FPGA device.

5. 1 DE10-Lite Factory Configuration

The DE10-Lite board has a default configuration bit-stream pre-programmed, which demonstrates some of the basic features onboard. The setup required for this demonstration and the location of its files are shown below.

Demonstration File Locations

- Project directory: \Default
- Bitstream used: DE10_LITE_Default.sof , DE10_LITE_Default.pof

Demonstration Setup and Instructions

- Connect the DE10-Lite board (J3) to the host PC with a USB cable and install the USB-Blaster driver if necessary.
- Execute the demo batch file “**test.bat**” from the directory \Default\demo_batch\
- You should now be able to observe the 7-segment displays are showing a sequence of characters, and the red LEDs are blinking. When putting SW0 to high position and swing the board, the red LEDs will act like gradienter.
- Press **KEY0** to make red LEDs and 7-segment all light up.
- If the VGA D-SUB connector is connected to a VGA display, it would show a color picture.

Restore Factory Configuration

Connect the DE10-Lite board (J3) to the host PC with a USB cable and install the USB-Blaster driver if necessary.

Execute the demo batch file “**program.bat**” from the directory \Default\demo_batch\

After the program is executed successfully, the program message as shown in **Figure 5-1**. Please press any key to continue and the window will be closed.

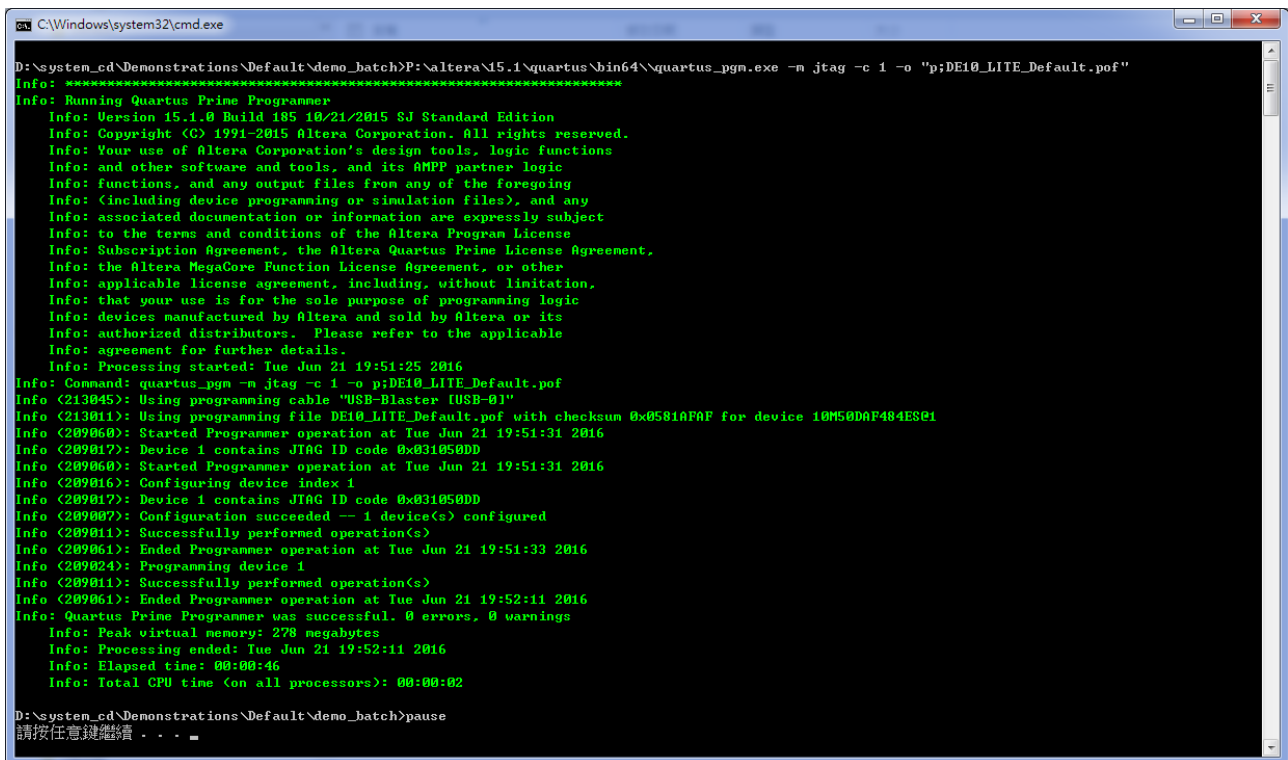

```
C:\Windows\system32\cmd.exe
D:\system_cd\Demonstrations\Default\demo_batch>P:\altera\15.1\quartus\bin64\quartus_pgm.exe -n jtag -c 1 -o "p;DE10_LITE_Default.pof"
Info:
Info: Running Quartus Prime Programmer
Info: Version 15.1.0 Build 185 10/21/2015 SJ Standard Edition
Info: Copyright (C) 1991-2015 Altera Corporation. All rights reserved.
Info: Your use of Altera Corporation's design tools, logic functions
Info: and other software and tools, and its AMPP partner logic
Info: functions, and any output files from any of the foregoing
Info: (including device programming or simulation files), and any
Info: associated documentation or information are expressly subject
Info: to the terms and conditions of the Altera Program License
Info: Subscription Agreement, the Altera Quartus Prime License Agreement,
Info: the Altera MegaCore Function License Agreement, or other
Info: applicable license agreement, including, without limitation,
Info: that your use is for the sole purpose of programming logic
Info: devices manufactured by Altera and sold by Altera or its
Info: authorized distributors. Please refer to the applicable
Info: agreement for further details.
Info: Processing started: Tue Jun 21 19:51:25 2016
Info: Command: quartus_pgm -m jtag -c 1 -o p;DE10_LITE_Default.pof
Info (213045): Using programming cable "USB-Blaster [USB-01]"
Info (213011): Using programming file DE10_LITE_Default.pof with checksum 0x0581AF0F for device 10M50DAF484ESE1
Info (209060): Started Programmer operation at Tue Jun 21 19:51:31 2016
Info (209017): Device 1 contains JTAG ID code 0x031050DD
Info (209060): Started Programmer operation at Tue Jun 21 19:51:31 2016
Info (209016): Configuring device index 1
Info (209017): Device 1 contains JTAG ID code 0x031050DD
Info (209007): Configuration succeeded -- 1 device(s) configured
Info (209011): Successfully performed operation(s)
Info (209061): Ended Programmer operation at Tue Jun 21 19:51:33 2016
Info (209024): Programming device 1
Info (209011): Successfully performed operation(s)
Info (209061): Ended Programmer operation at Tue Jun 21 19:52:11 2016
Info: Quartus Prime Programmer was successful. 0 errors, 0 warnings
Info: Peak virtual memory: 278 megabytes
Info: Processing ended: Tue Jun 21 19:52:11 2016
Info: Elapsed time: 00:00:46
Info: Total CPU time (on all processors): 00:00:02
D:\system_cd\Demonstrations\Default\demo_batch>pause
請按任意鍵繼續 . . . .
```

Figure 5-1 Quartus II Program MAX 10 CFM message

5. 2 SDRAM Test in Nios II

There are many applications using SDRAM as a temporary storage. Both hardware and software designs are provided to illustrate how to perform memory access in Qsys in this demonstration. It also shows how Altera's SDRAM controller IP accesses SDRAM and how the Nios II processor reads and writes the SDRAM for hardware verification. The SDRAM controller handles complex aspects of accessing SDRAM such as initializing the memory device, managing SDRAM banks, and keeping the devices refreshed at certain interval.

■ System Block Diagram

Figure 5-2 shows the system block diagram of this demonstration. The system requires a 50 MHz clock input from the board. The SDRAM controller is configured as a 64MB controller. The working frequency of the SDRAM controller is 120 MHz, and the Nios II program is running on the on-chip memory.

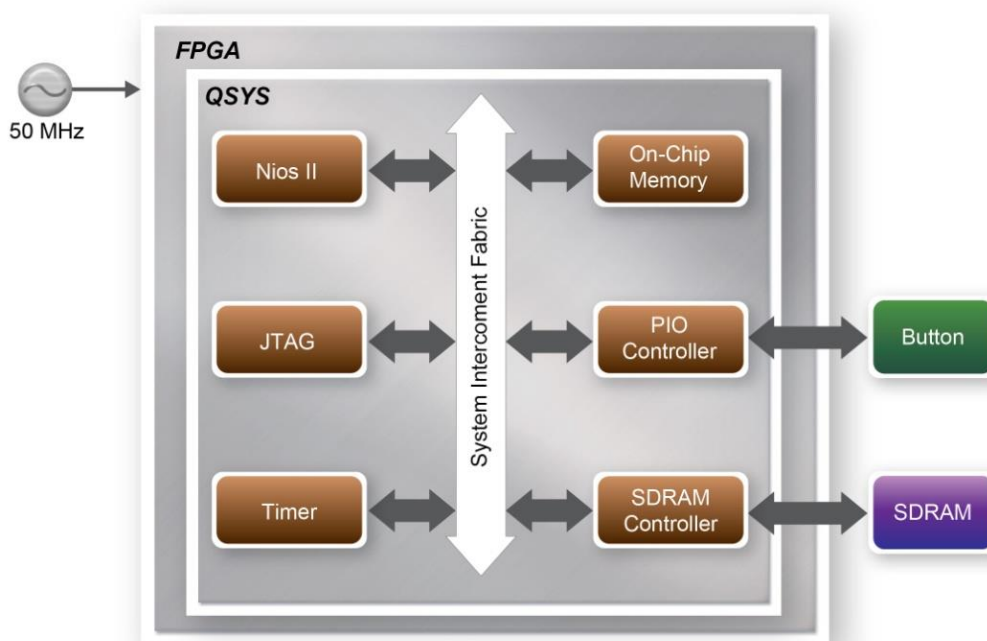

Figure 5-2 Block diagram of the SDRAM test in Nios II

The system flow is controlled by a program running in Nios II. The Nios II program writes test patterns into the entire 64MB of SDRAM first before calling the Nios II system function, `alt_dcache_flush_all`, to make sure all of the data is written to the SDRAM. It then reads data from the SDRAM for data verification. The program will show the progress in nios-terminal when writing/reading data to/from the SDRAM. When the verification process reaches 100%, the result will be displayed in nios-terminal.

Design Tools

- Quartus II v16.0
- Nios II Eclipse v16.0

Demonstration Source Code

- Quartus project directory: \SDRAM_Nios_Test
- Nios II Eclipse directory: \SDRAM_Nios_Test\Software

Nios II Project Compilation

- Click “Clean” from the “Project” menu of Nios II Eclipse before compiling the reference design in Nios II Eclipse.

Demonstration Batch File

The files are located in the director: \SDRAM_Nios_Test\demo_batch

The folder includes the following files:

- Batch file for USB-Blaster : test.bat and test.sh
- FPGA configuration file : DE10_LITE_SDRAM_Nios_Test.sof
- Nios II program: DE10_LITE_SDRAM_Nios_Test.elf

Demonstration Setup

- Quartus II v16.0 and Nios II v16.0 must be pre-installed on the host PC.
- Connect the DE10-Lite board (J3) to the host PC with a USB cable and install the USB-Blaster driver if necessary.
- Execute the demo batch file “**test.bat**” from the directory \SDRAM_Nios_Test\demo_batch
- After the program is downloaded and executed successfully, a prompt message will be displayed in nios2-terminal.
- Press any button (**KEY0~KEY1**) to start the SDRAM verification process. Press **KEY0** to run the test continuously.
- The program will display the test progress and result, as shown in **Figure 5-3**.

```
Resetting and pausing target processor: OK
Initializing CPU cache (if present)
OK
Downloaded 71KB in 1.0s (71.0KB/s)
Verified OK
Starting processor at address 0x04020240
nios2-terminal: connected to hardware target using JTAG UART on cable
nios2-terminal: "USB-Blaster [USB-0]", device 1, instance 0
nios2-terminal: (Use the IDE stop button or Ctrl-C to terminate)

==== SDRAM Test! Size=64MB (CPU Clock:120000000) ====

=====
Press any KEY to start test [KEY0 for continued test]
====> SDRAM Testing, Iteration: 1
write...
10% 20% 30% 40% 50% 60% 70% 80% 90% 100%
read/verify...
10% 20% 30% 40% 50% 60% 70% 80% 90% 100%
SDRAM test:Pass, 12 seconds
====> SDRAM Testing, Iteration: 2
write...
10% 20% 30% 40% 50% 60% 70% 80% 90% 100%
read/verify...
10% 20% 30% 40% 50% 60% 70% 80%
```

Figure 5-3 Display of progress and result for the SDRAM test in Nios II

5.3 SDRAM Test in Verilog

DE10-Lite system CD offers another SDRAM test with its test code written in Verilog HDL. The memory size of the SDRAM bank tested is still 64MB.

■ Function Block Diagram

Figure 5-4 shows the function block diagram of this demonstration. The SDRAM controller uses 50 MHz as a reference clock and generates 100 MHz as the memory clock.

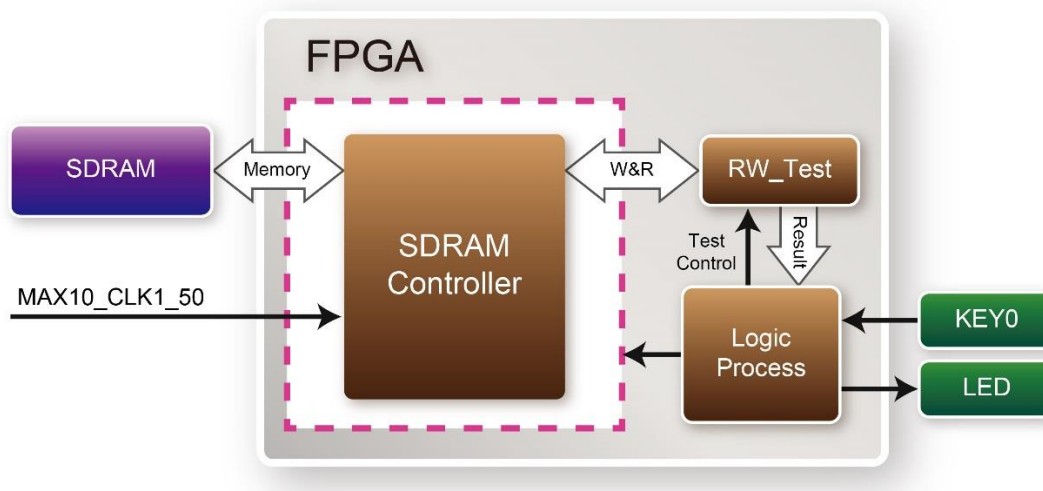

Figure 5-4 Block diagram of the SDRAM test in Verilog

RW_Test module writes the entire memory with a test sequence first before comparing the data read back with the regenerated test sequence, which is the same as the data written to the memory.

KEY0 triggers test control signals for the SDRAM, and the LEDs will indicate the test result according to **Table 5-1**.

Design Tools

- Quartus II v16.0

Demonstration Source Code

- Project directory: \SDRAM_RTL_Test
- Bit-stream used: DE10_LITE_SDRAM_RTL_Test.sof

Demonstration Batch File

Demo batch file folder: \SDRAM_RTL_Test\demo_batch

The directory includes the following files:

- Batch file : test.bat
- FPGA configuration file : DE10_LITE_SDRAM_RTL_Test.sof

Demonstration Setup

- Quartus II v16.0 must be pre-installed to the host PC.
- Connect the DE10-Lite board (J3) to the host PC with a USB cable and install the USB-Blaster driver if necessary
- Execute the demo batch file “**test.bat**” from the directory \SDRAM_RTL_Test\demo_batch
- Press **KEY0** on the DE10-Lite board to start the verification process. When **KEY0** is pressed, the **LEDR [2:0]** should turn on. When **KEY0** is then released, **LEDR1** and **LEDR2** should start blinking.
- After approximately 8 seconds, **LEDR1** should stop blinking and stay ON to indicate the test is PASS. **Table 5-1** lists the status of LED indicators.
- If **LEDR2** is not blinking, it means 50MHz clock source is not working.
- If **LEDR1** failed to remain ON after approximately 8 seconds, the SDRAM test is NG.
- Press **KEY0** again to repeat the SDRAM test.

Table 5-1 Status of LED Indicators

Name	Description
LEDR1	ON if the test is PASS after releasing KEY0
LEDR2	Blinks

5.4 VGA Pattern

This demonstration displays a simple blue, red and green color pattern on a VGA monitor using the VGA output interface on DE10-Lite board. **Figure 5-5** shows the block diagram of the design.

The major block called video_sync_generator generates the VGA timing signals, horizontal synchronization, vertical synchronization and blank in standard VGA resolution (640x480 pixels, at 25 MHz).

These signals will be used in vga_controller block for RGB data generation and data output. Please refer to the chapter 3.8 in DE10-Lite_User_Manual on the DE10-Lite System CD for detailed information of using the VGA output.

As shown in **Figure 5-6**, the RGB data drives each pixel in turn across the row being displayed after the time period of back porch.

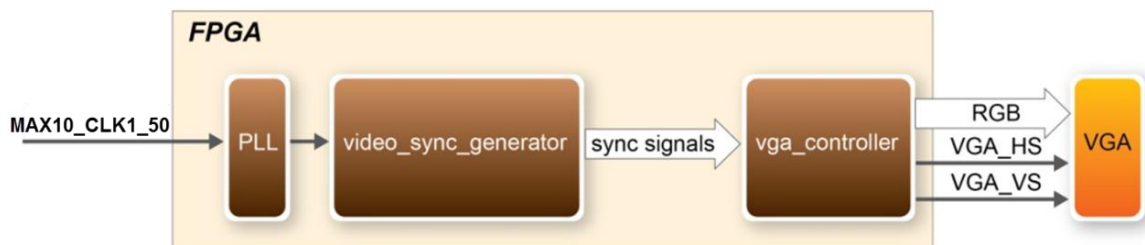

Figure 5-5 Block diagram of the VGA Pattern demonstration

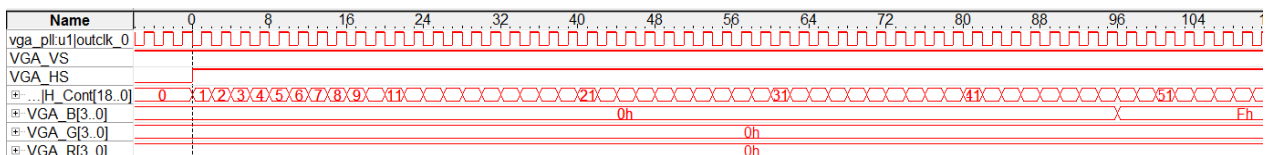

Figure 5-6 Timing Waveform of VGA interface

Design Tools

- Quartus II 16.0

Demonstration Source Code

- Quartus Project directory: \VGA_Pattern
- Bit-stream used: DE10_LITE_VGA_Pattern.sof

Demonstration Batch File

Demo Batch File Folder: \VGA_Pattern\demo_batch

The demo batch file includes following files:

- Batch File for USB-Blaster: test.bat
- FPGA Configure File: DE10_LITE_VGA_Pattern.sof

Demonstration Setup

- Quartus II v16.0 must be pre-installed to the host PC..
- Connect the DE10-Lite board (J3) to the host PC with a USB cable and install the USB-Blaster driver if necessary
- Connect VGA D-SUB to a VGA monitor.
- Execute the demo batch file “**test.bat**” from the directory : \VGA_Pattern\demo_batch\
- The VGA monitor will display a color pattern.
- **Figure 5-7** illustrates the setup for this demonstration.

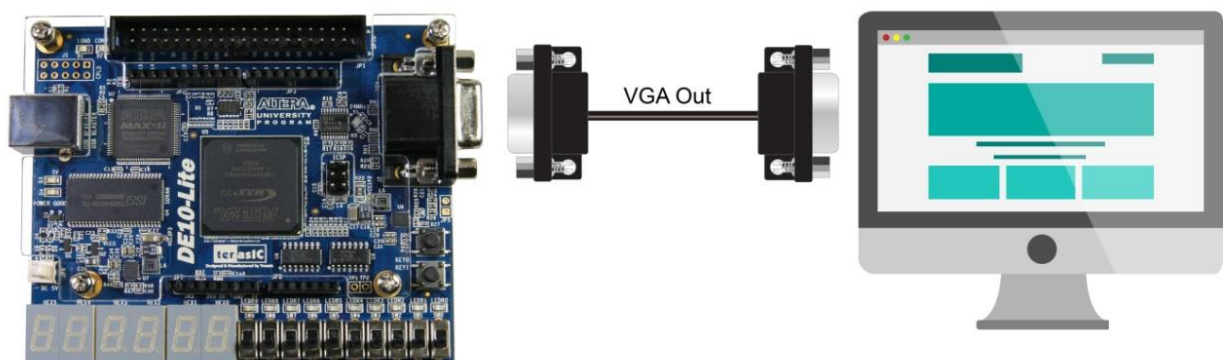

Figure 5-7 The setup for the VGA Pattern demonstration

5.5 G-Sensor

This demonstration illustrates how to use the digital accelerometer on the DE10-Lite board to measure the static acceleration of gravity in tilt-sensing applications. As the board is tilted from left to right and right to left, the digital accelerometer detects the tilting movement and displays it on the LEDs.

■ Function Block Diagram

Figure 5-8 shows the system block diagram of this demonstration. In this system, the accelerometer is controlled through a 3-wire SPI. Before reading any data from the accelerometer, the controller sets 1 on the SPI bit in the Register 0x31 – DATA_FORMAT register. The 3-wire SPI Controller block reads the digital accelerometer X-axis value, to determine the tilt of the board. The LEDs are lit up as if they were a bubble, floating to the top of the board.

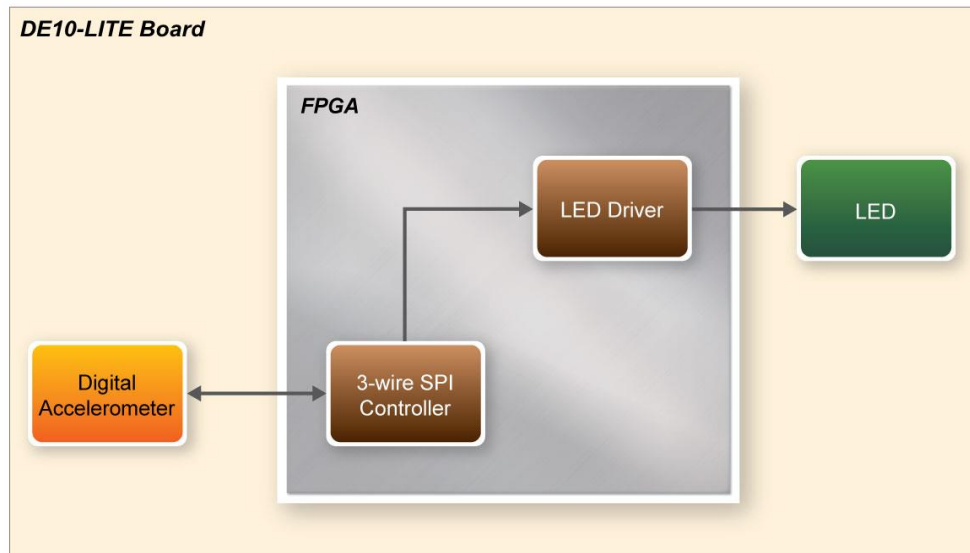

Figure 5-8 Block diagram of the G-Sensor

Design Tools

- Quartus II v16.0

Demonstration Source Code

- Project directory: \GSensor
- Bitstream used: DE10_LITE_GSensor.sof

Demonstration Batch File

Demo batch file folder: \GSensor\demo_batch

The directory includes the following files:

- Batch file: test.bat
- FPGA configuration file: DE10_LITE_GSensor.sof

Demonstration Setup

- Quartus II v16.0 must be pre-installed to the host PC.
- Connect the DE10-Lite board (J3) to the host PC with a USB cable and install the USB-Blaster driver if necessary
- Execute the demo batch file “**test.bat**” from the directory \GSensor\demo_batch. This will load the demo into the FPGA.
- Tilt the DE10-Lite board from side to side and observe the result on the LEDs.

5.6 ADC Measurement

This demonstration shows how to use the FPGA on-die ADC to measure the input power voltage from the six analog input pins among the Arduino connector. The measured voltage is displayed on the six 7-segment display. **Figure 5-9** shows the block diagram of this demonstration. The main control uses the Altera ADC IP to retrieve the 12-bit digitalized analog value according to the channel specified by the SWITCH on the DE10-Lite. The input voltage can be calculated based on the 12-bit digital value. Finally, the voltage value will be display on the 7-segment display by using the 7-segment controller.

The 12-bit represents 0~2.5V input voltage to the ADC hardware. In the ADC front-end circuit, the output voltage is half of the input voltage. So the input voltage to the ARDUINO analog input can be calculated with the formula listed below:

$$VOL_{input} = (12\text{-bit integer value}) / 4095 \times 2.5 \times 2 = (12\text{-bit integer value}) / 4095 \times 5.0$$

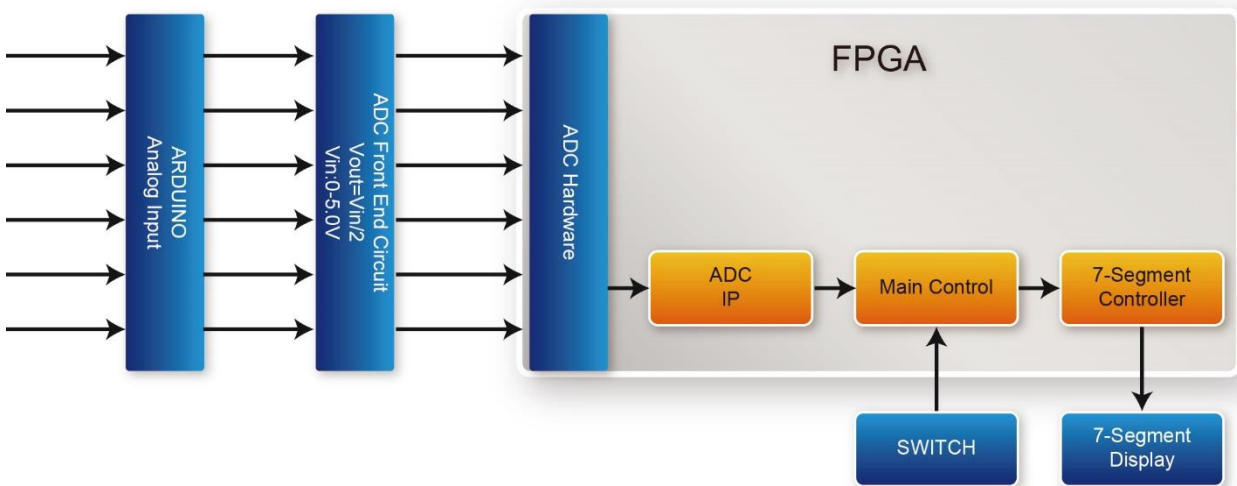

Figure 5-9 Block diagram of the ADC measurement demonstration

In the demonstration, a Signal Tap is also provided to display the retrieved 12-bit digitalized value and the calculated voltage for the input power to the ARDUINO analog input as shown in **Figure 5-10**.

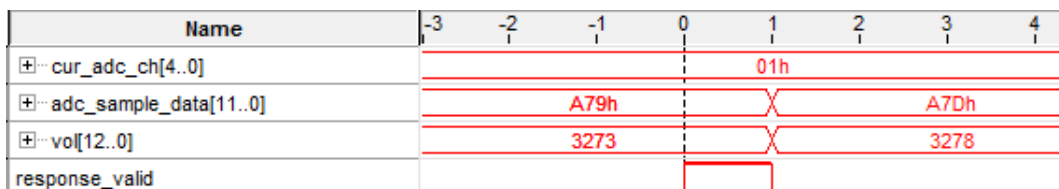

Figure 5-10 Signal Tap of ADC

Design Tools

- Quartus II 16.0

Demonstration Source Code

- Quartus Project directory: \ADC_RTL
- Bitstream used: DE10_Lite.sof

Demonstration Batch File

Demo Batch File Folder: \ADC_RTL\demo_batch

The demo batch file includes following files:

- Batch File for USB-Blaster: test.bat
- FPGA Configure File: DE10_Lite.sof

Demonstration Setup

- Quartus II 16.0 must be pre-installed to the host PC..
- Connect USB Blaster to the DE10-Lite board and install USB Blaster driver if necessary.
- Execute the demo batch file “**test.bat**” from the directory\ADC_RTL\demo_batch.
- Use SW[2:0] to specify measured analog input channel.
- The measured channel and voltage will be displayed on the 7-segment display as shown in [Figure 5-11](#).

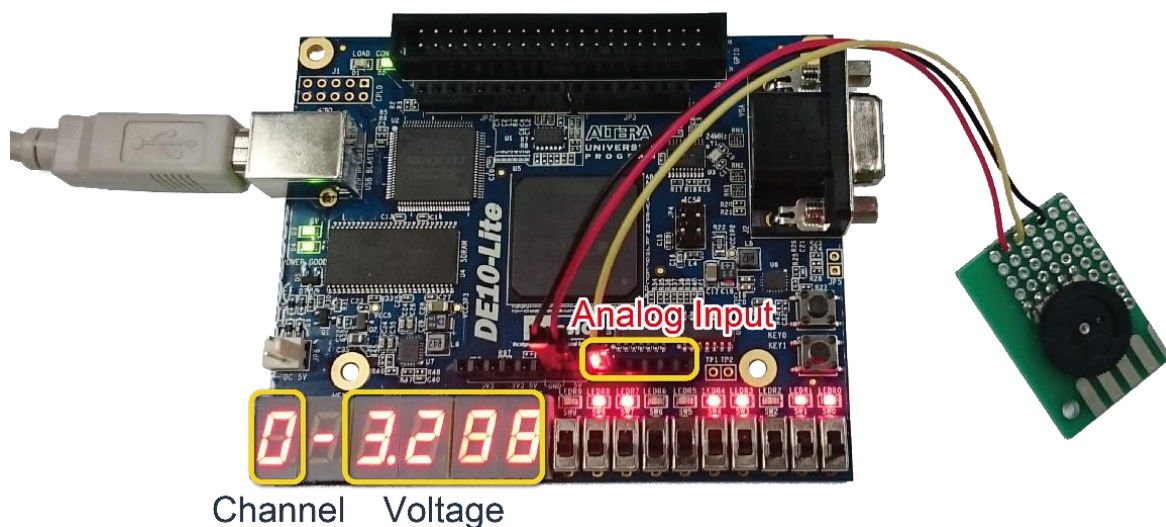

Figure 5-11 7-Segment display the measured channel and voltage

Programming the Configuration Flash Memory

This tutorial provides comprehensive information that will help you understand how to configure DE10-Lite Board using internal configuration mode. The MAX 10 device on DE10-Lite Board supports single and dual image boot. This tutorial explains the details of the dual image boot. The following sections provide a quick overview of the design flow.

Please note that if you are using the dual image boot function on the DE10-Lite board, you will need to solder the JP5 2-pin header (pitch 0.100" (2.54 mm)) by yourself.

The JP5 position please refer to the **Figure 6-1**.

The settings of JP5 are described in **Table 6-1**.

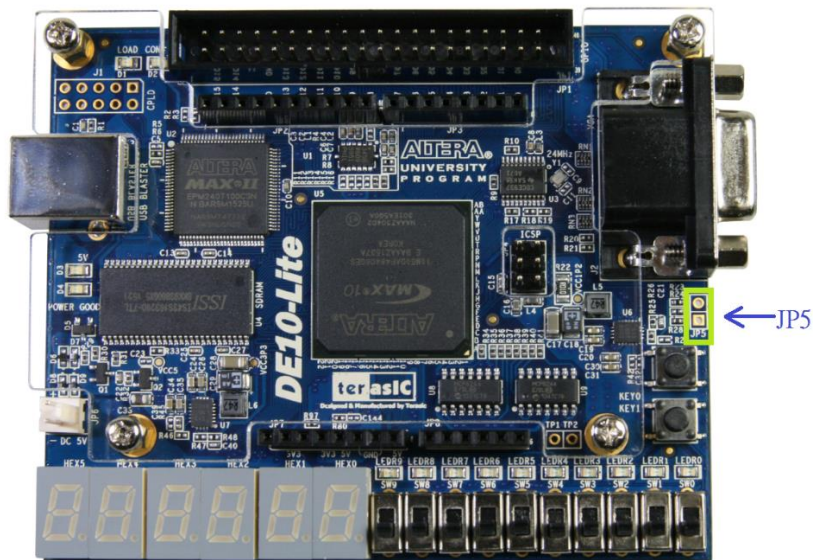

Figure 6-1 JP5 position on the DE10-Lite board.

Table 6-1 JP5 Jumper setting instructions

Reference	Jumper Setting	Description
JP5	Open (default)	Boot from image 0
	Close	Boot from image 1

6.1 Internal Configuration

The internal configuration scheme for all MAX 10 devices except for 10M02 device consists of the following mode:

- Dual Compressed Images — configuration image is stored as image0 and image1 in the configuration flash memory (CFM).
- Single Compressed Image.
- Single Compressed Image with Memory Initialization.
- Single Uncompressed Image.
- Single Uncompressed Image with Memory Initialization.

In dual compressed images mode, you can use the BOOT_SEL pin to select the configuration image.

The High-Level Overview of Internal Configuration for MAX 10 Devices as shown in **Figure 6-2**.

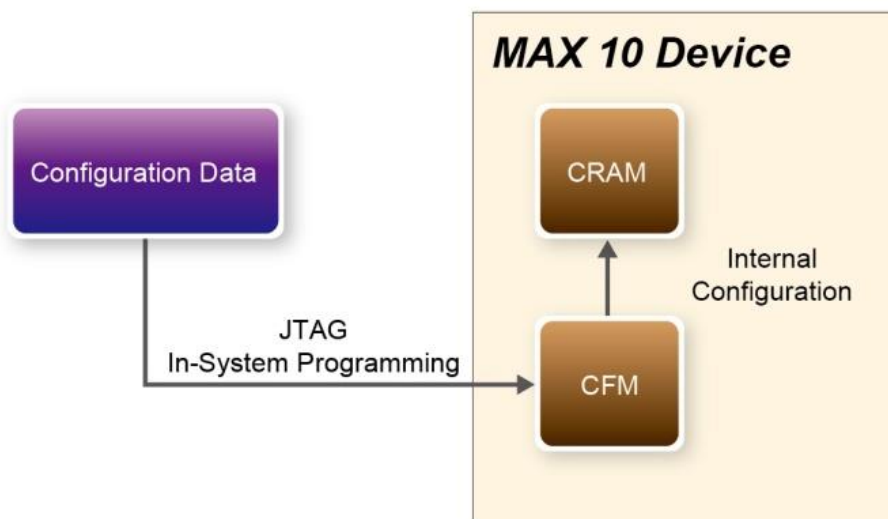

Figure 6-2 High-Level Overview of Internal Configuration for MAX 10 Devices

Before internal configuration, we need to program the configuration data into the configuration flash memory (CFM). The CFM will be part of the programmer object file (.pof) programmed into the internal flash through the JTAG In-System Programming (ISP).

During internal configuration, MAX 10 devices load the configuration RAM (CRAM) with configuration data from the CFM. Both of the application configuration images, image 0 and image 1, are stored in the CFM. The MAX 10 device loads either one of the application configuration image from the CFM. If an error occurs, the device will automatically load the other application configuration image. Remote System Upgrade Flow for MAX 10 Devices is shown in **Figure 6-3**.

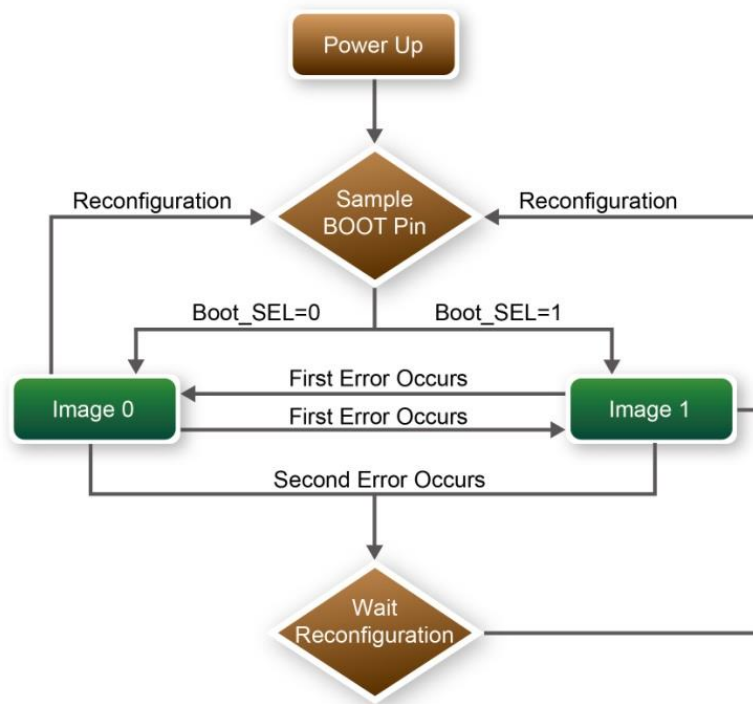

Figure 6-3 Remote System Upgrade Flow for MAX 10 Devices

The operation of the remote system upgrade feature detecting errors is as follows:

1. After powering-up, the device samples the BOOT_SEL pin to determine which application configuration image to boot. The BOOT_SEL pin setting can be overwritten by the input register of the remote system upgrade circuitry for the subsequent reconfiguration.
2. If an error occurs, the remote system upgrade feature reverts by loading the other application configuration image. The following lists the errors that will cause the remote system upgrade feature to load another application configuration image:
 - Internal CRC error
 - User watchdog timer time-out
3. Once the revert configuration completes and the device is in the user mode, you can use the remote system upgrade circuitry to query the cause of error and which application image failed.
4. If a second error occurs, the device waits for a reconfiguration source. If the auto-reconfig is enabled, the device will reconfigure without waiting for any reconfiguration source.
5. Reconfiguration is triggered by the following actions:
 - Driving the nSTATUS low externally
 - Asserting internal or external nCONFIG low
 - Asserting RU_nCONFIG low (Avalon-MM interface signal)

6.2 Using Dual Compressed Images

The internal configuration scheme for all MAX 10 devices except for 10M02 device consists of the following mode:

- Dual Compressed Images — configuration image is stored as image 0 and image 1 in the configuration flash memory(CFM).
- Single Compressed Image.

This section will just introduce how to use MAX 10 device Dual Compressed Images feature. If you don't need this feature, skip this section

Before using MAX 10 Dual Compressed Images feature, users need to set these two image files' Quartus II projects as follows:

- Add dual configuration IP.
- Modify Configuration Mode in device setting.

First of all, a **Dual Configuration IP** should be added in an original project, so that the .pof file can be programmed into CFM through it. Here we use a demonstration named "**Led Breathe**" as an example to add Altera Dual Configuration IP to the project:

1. Open Quartus project and choose **Tools > Qsys** to open Qsys system wizard as shown in **Figure 6-4**.

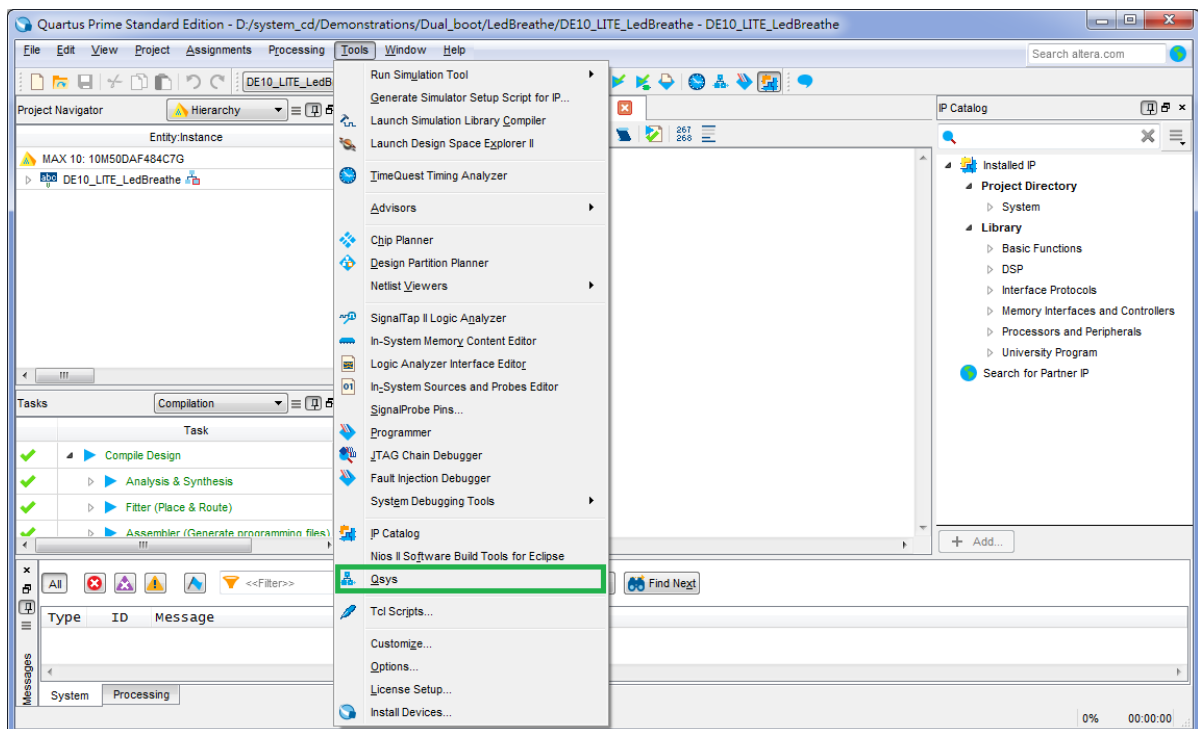

Figure 6-4 Select Qsys menu and click

- Please choose **Library > Basic Function> Configuration and Programming > Altera Dual Configuration** to open wizard of adding dual boot IP. See **Figure 6-5** and **Figure 6-6**.

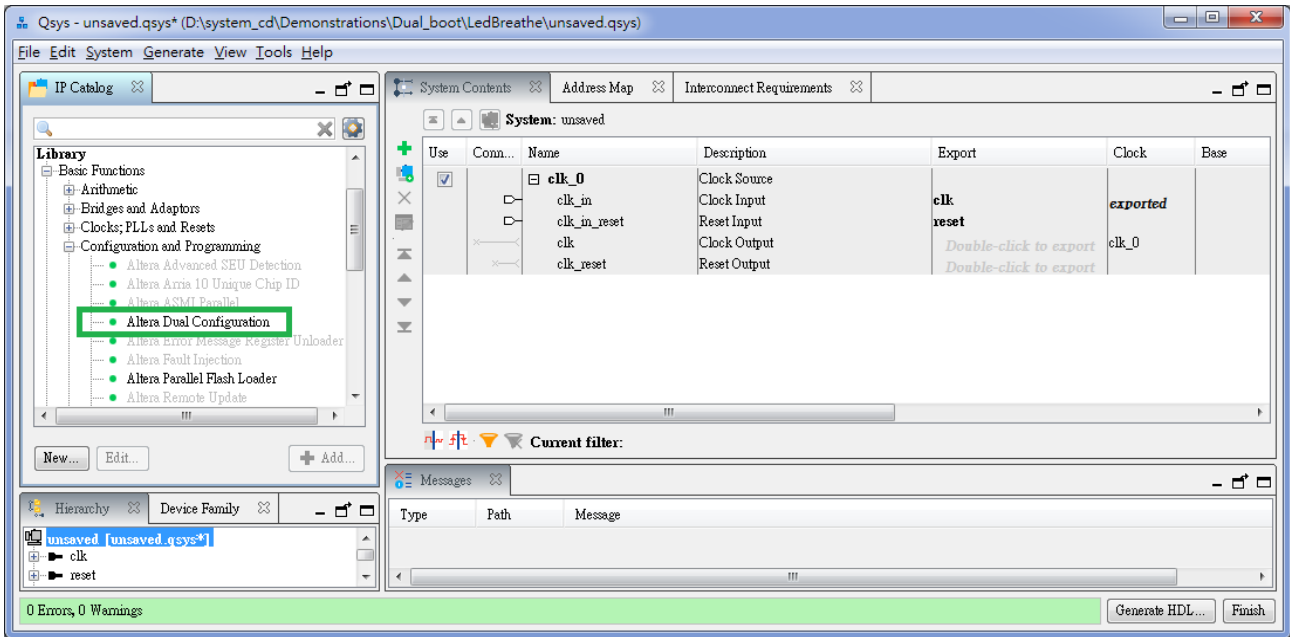

Figure 6-5 Select Altera Dual Configuration IP and click.

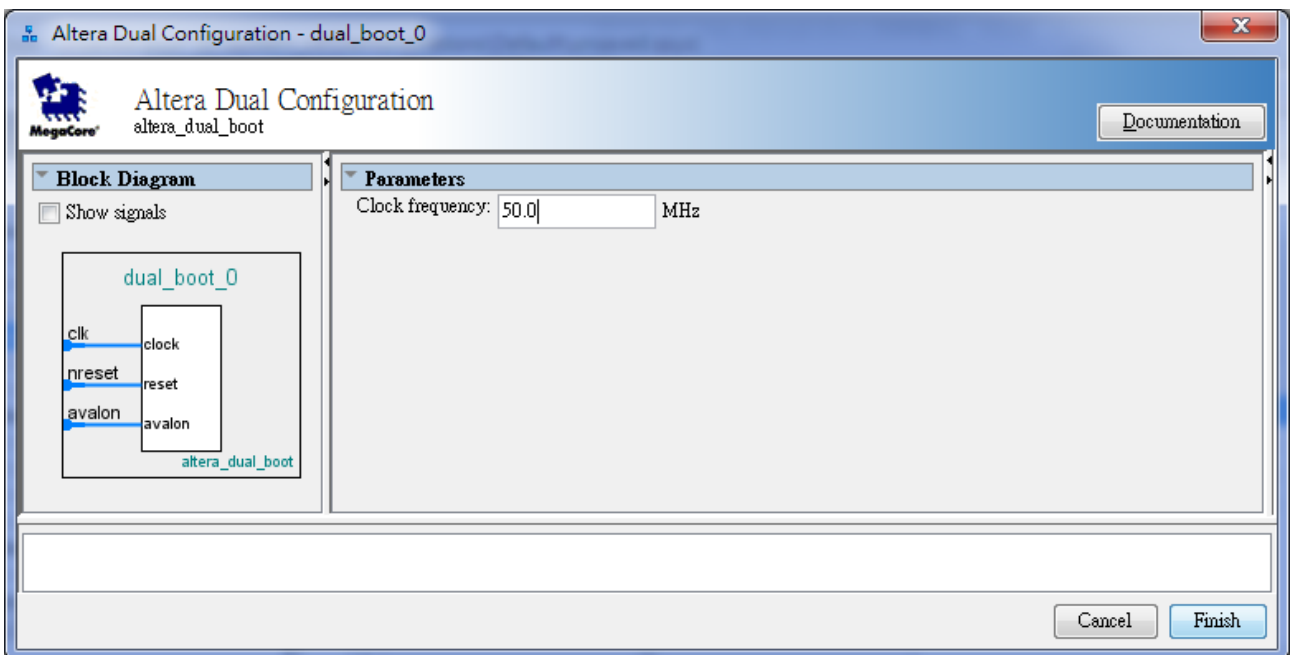

Figure 6-6 Open wizard and click Finish.

- Click **Finish** to close the wizard and return to the Qsys window. Choose **dual_boot_0** and click right key to select **Rename** it to **dual_boot**, and connect the **clk** and **nreset** to **clk_0.clk** and **clk_0.clk_reset** as shown in **Figure 6-7**.

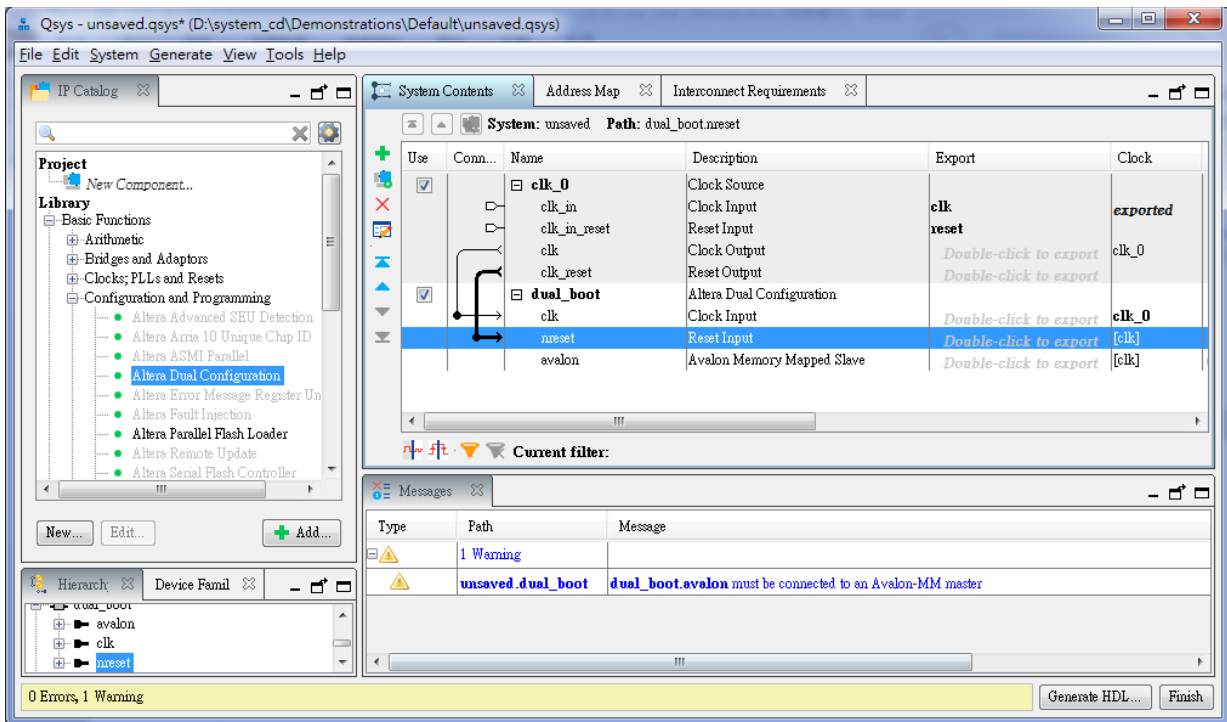

Figure 6-7 Rename and connect dual boot IP OK

- Choose **Generate > Generate HDL..** and click **Generate** then pop a window as shown in **Figure 6-8**. Click **Save** it as **dual_boot.qsys** and the generation start. If there is no error in the generation, the window will show successful as shown in **Figure 6-9**.

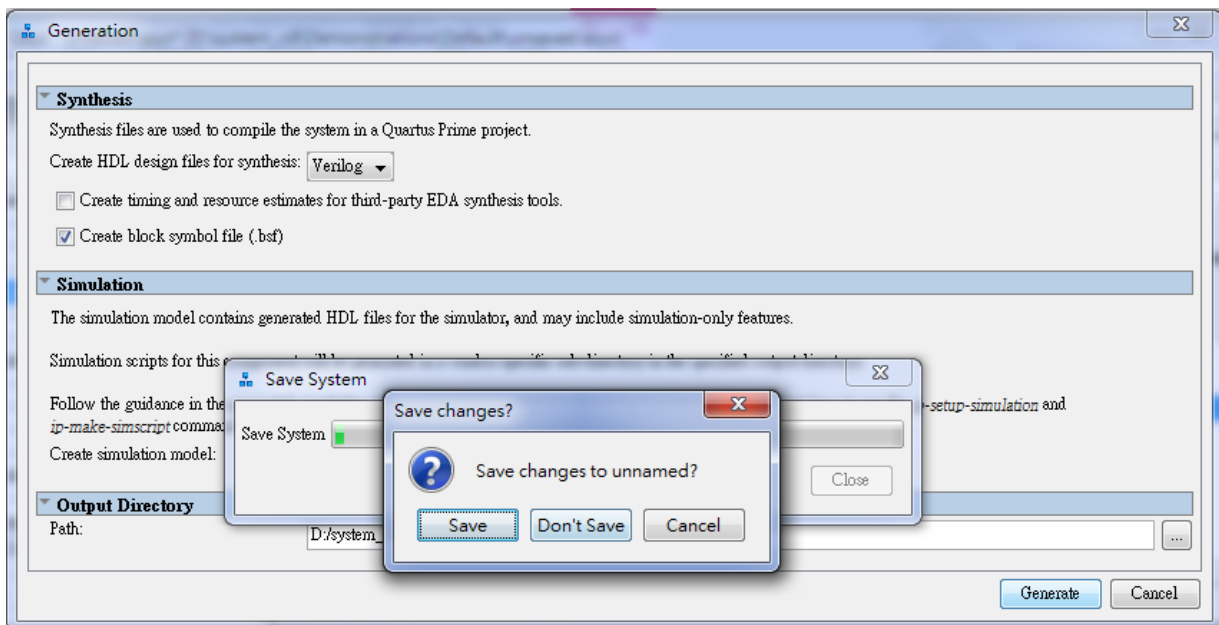

Figure 6-8 Generate and Save Qsys.

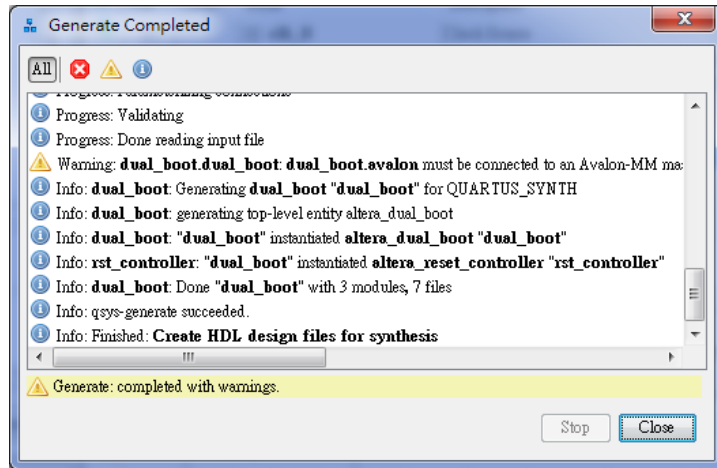

Figure 6-9 Generate completed.

5. Click **Close** and **Finish** to return to the window and add the dual_boot qsys into the top file as shown in **Figure 6-10**, and add the dual_boot.qip file to the project and save.

```

dual_boot u0 (
    .clk_clk (MAX10_CLK1_50), // clk.clk
    .reset_reset_n (1'b1) // reset.reset_n
);

```

Figure 6-10 Add the dual_boot module in top file.

Secondly, the project needs to be set before the compilation. After adding dual_boot IP successfully, please set the project mode as Internal Configuration mode, detail steps are as follows:

1. Choose **Assignments > Device** to open Device windows shown in **Figure 6-11**.

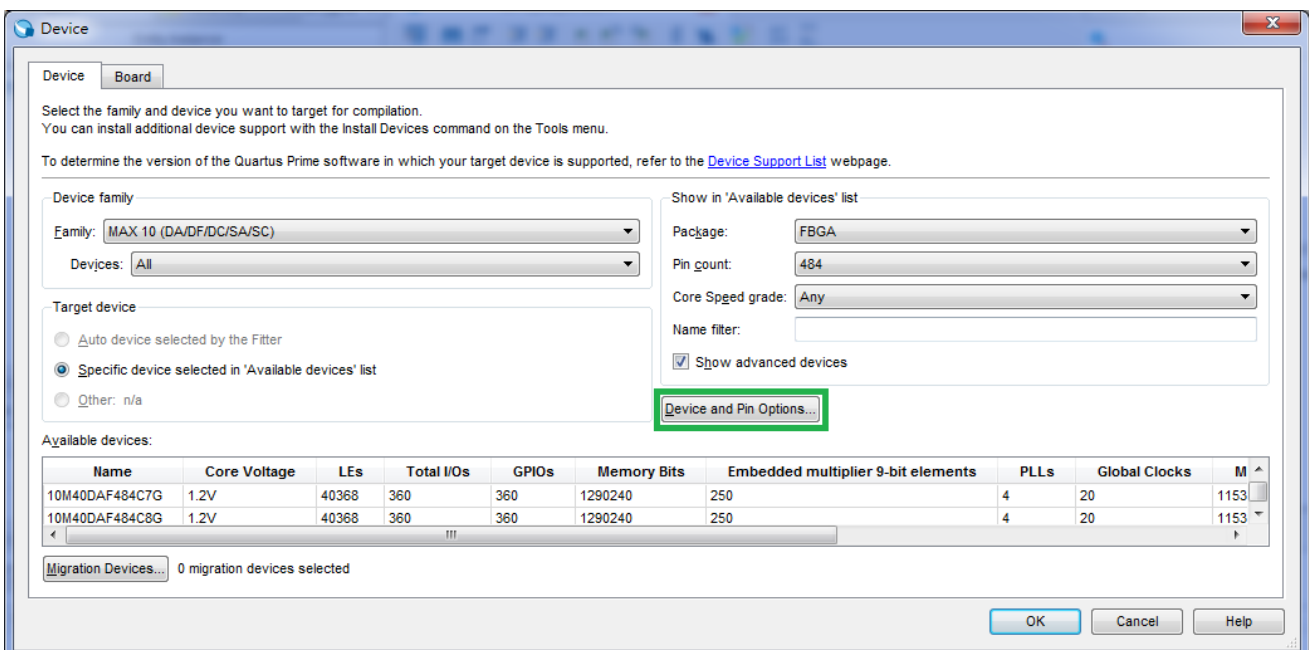

Figure 6-11 Open Device window...

2. Click **Device and Pin Opinions** to open the Device and Pin Opinions windows, and in the **Configuration** tab, Set the **Configuration Scheme** to **Internal Configuration** and the **Configuration Mode** to **Dual Compressed Images**. Check the Option of **Generate compressed bitstreams**. shown in **Figure 6-12**.

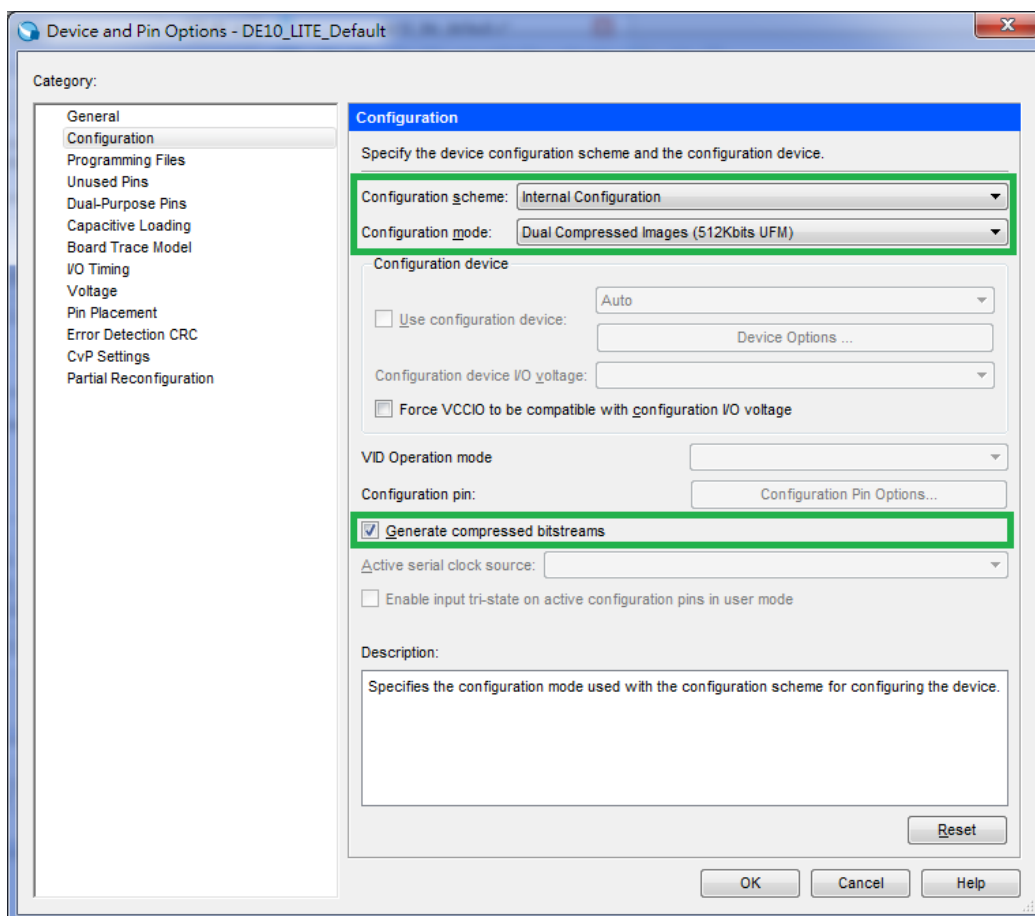

Figure 6-12 Set Dual Configuration Mode

3. Choose **OK** to return to the Quartus window. In the **Processing** menu, choose **Start Compilation** or click the Play button on the toolbar to compile the project, generate the new .sof file.
4. Use the same flow to add the Dual Configuration IP into other project to generate the new .sof file by internal configuration mode.

Finally, So far, we have successfully obtained two image .sof files for dual boot demo according previous steps. this section describes how to generate .pof from .sof files with the internal configuration mode and program the .pof into configuration flash memory (CFM) through the JTAG interface.

I. Convert .SOF File to .POF File

1. Choose **Convert Programming Files** from the File menu of Quartus II to open new window, as shown in **Figure 6-13**.

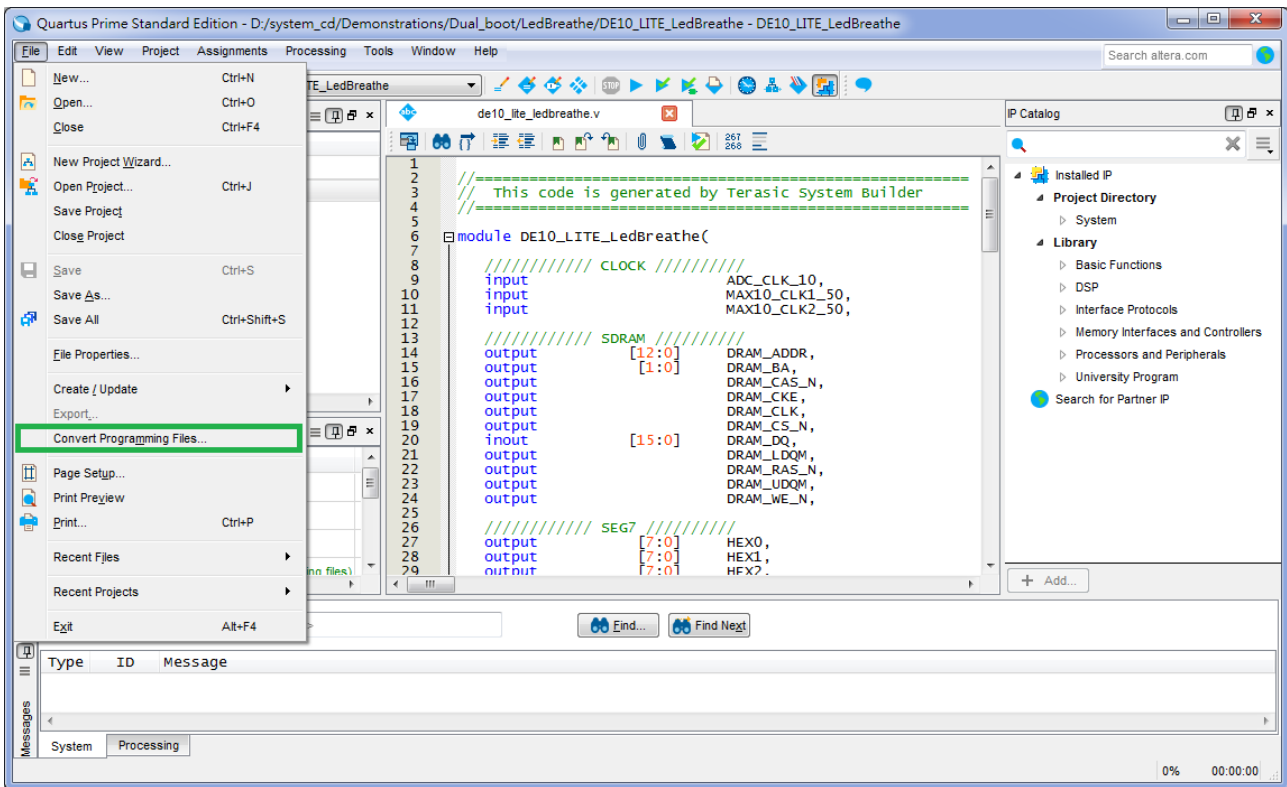

Figure 6-13 Select Convert Programming Files and click

2. Select **Programmer Object File (.pof)** from the **Programming file type** field in the dialog of Convert Programming Files.
3. Choose **Internal Configuration** from the **Mode** field.
4. Browse to the target directory from the **File name** field and specify the name of output file.
5. Click on the **SOE data** in the section of **Input files to convert**, as shown in **Figure 6-14**.

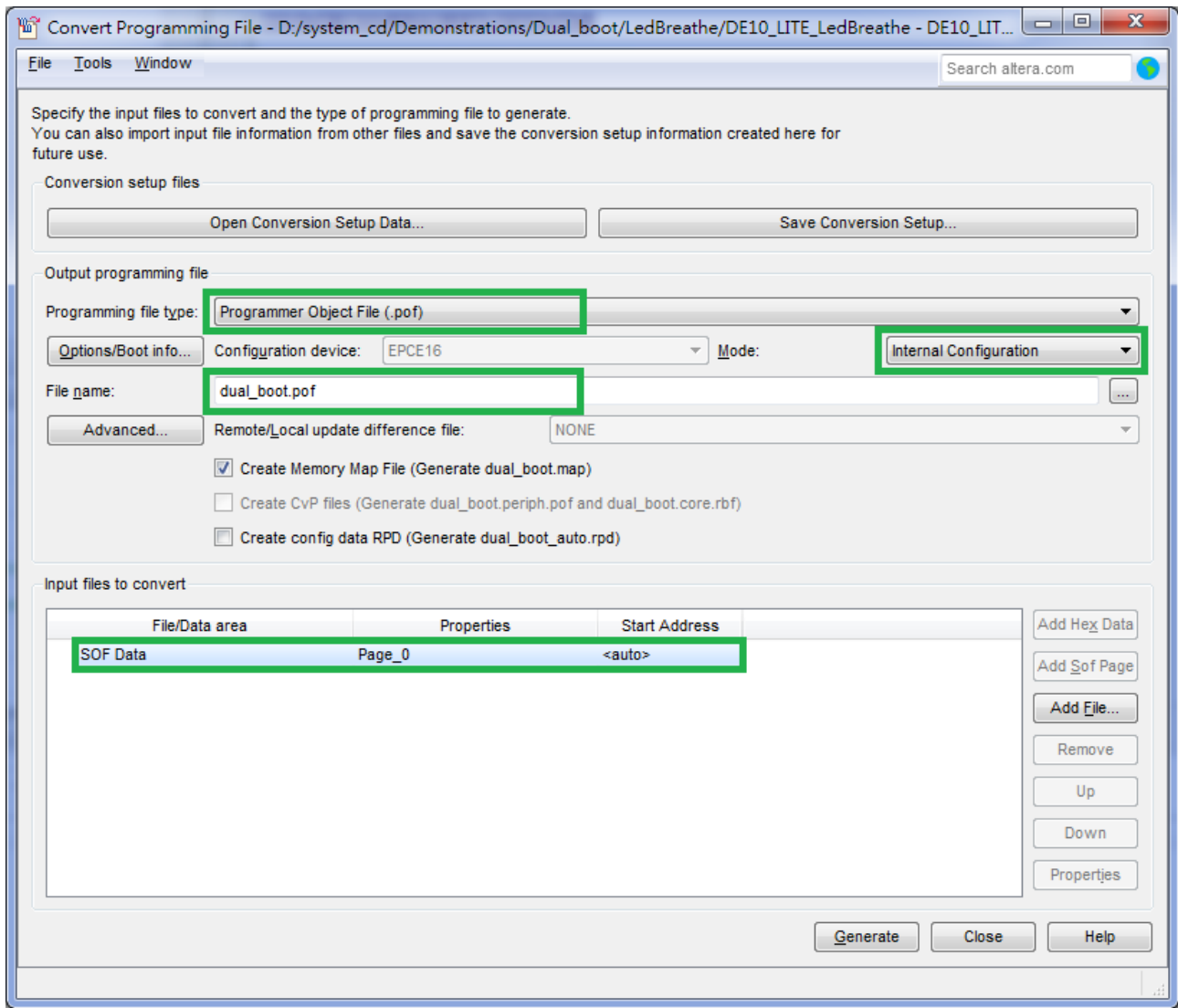

Figure 6-14 Dialog of Convert Programming Files and setting

6. Click **Add File** and select the DE10_LITE_LedBreathe.sof of LedBreathe demo to be the sof data of Page_0.
7. Click **Add Sof Page** to add Page_1 and click **Add File**, Select the DE10_LITE_GSensor.sof of GSensor demo to be the .sof data of Page_1 as shown in Figure 6-15.
8. Click Generate.

These project files can be found in the CD directorie \Demonstrations\Dual_boot\

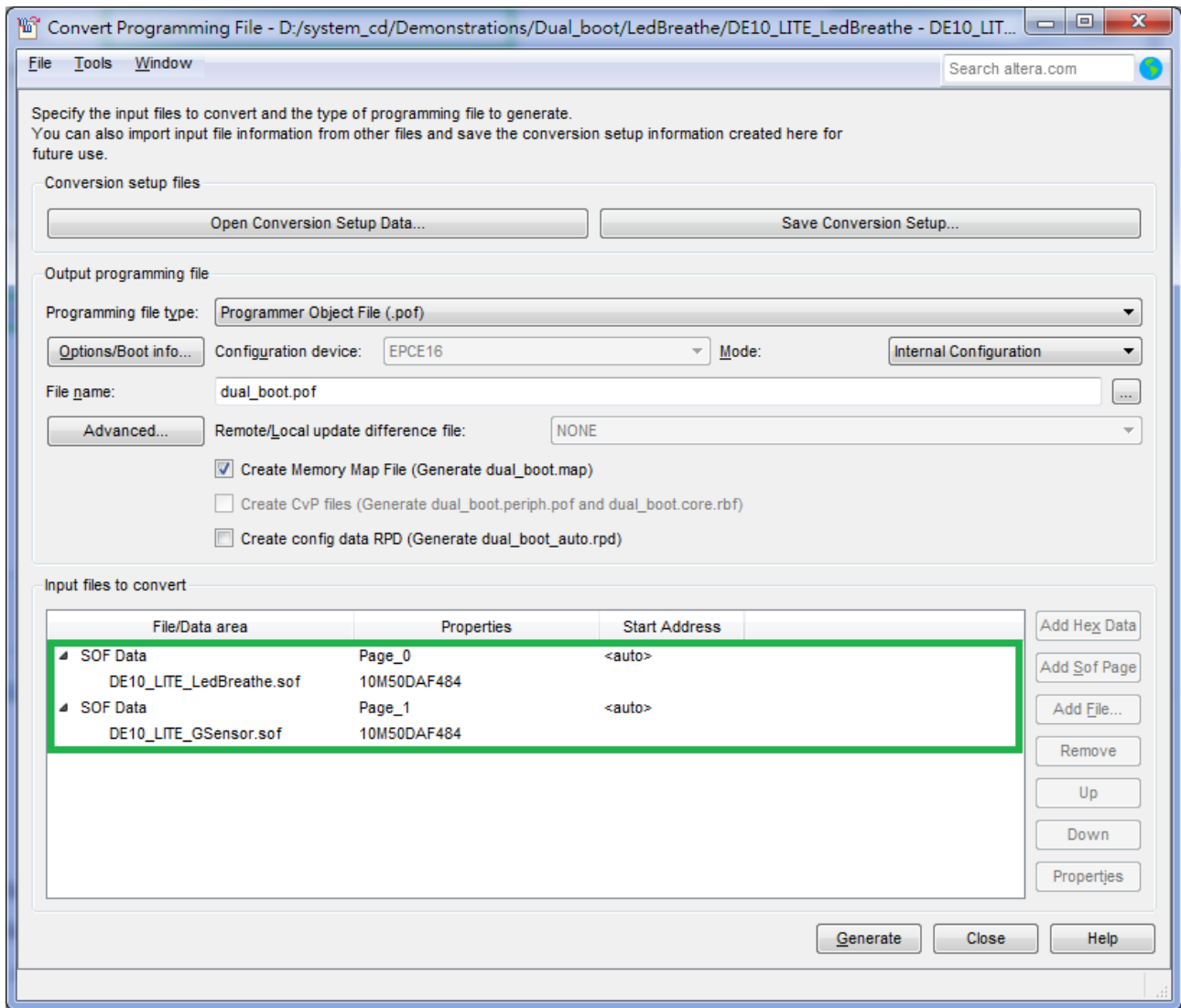

Figure 6-15 Add sof page and sof file

II. Write POF File into the CFM Device

When the conversion of SOF-to-POF file is complete, please follow the steps below to program the MAX 10 device with the .pof file created in Quartus II Programmer.

1. Choose **Programmer** from the **Tools** menu and the Chain.cdf window will appear.
2. Click **Hardware Setup** and then select the **USB-Blaster** as shown in **Figure 6-16**.
3. Click **Add File** and then select the dual_boot.pof.
4. Program the **CFM** device by clicking the corresponding **Program/Configure** and **Verify** box, as shown in **Figure 6-17**.
5. Click **Start** to program the **CFM** device.

Now, you can set the BOOT_SEL by JP5, you will find if you open JP5 (BOOT_SEL = 0), the Led Breathe functions would show. Power down the board, insert the jumper to JP5 (BOOT_SEL = 1), then Power on, you would find the Gsensor functions show.

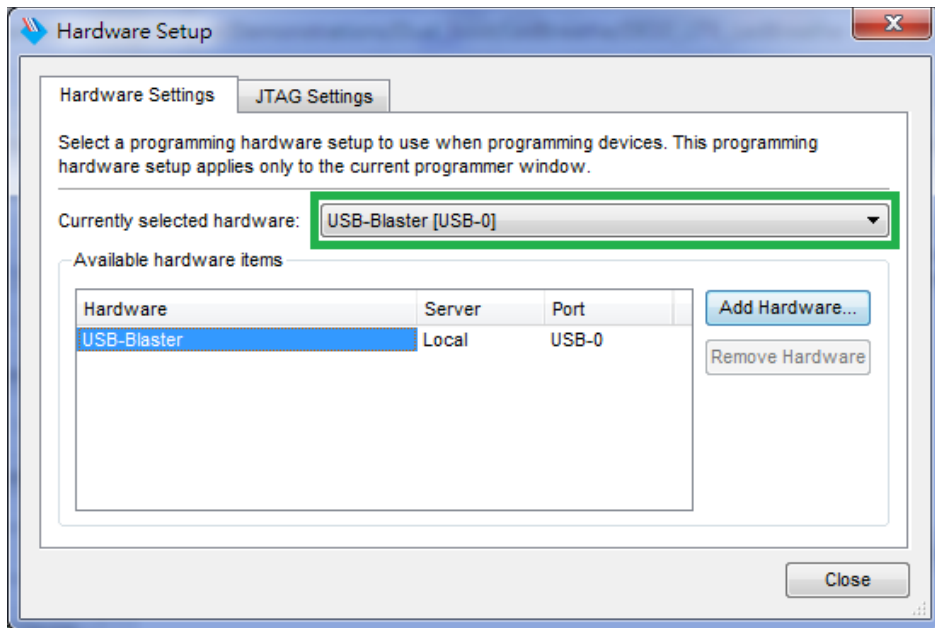

Figure 6-16 Hardware setup window

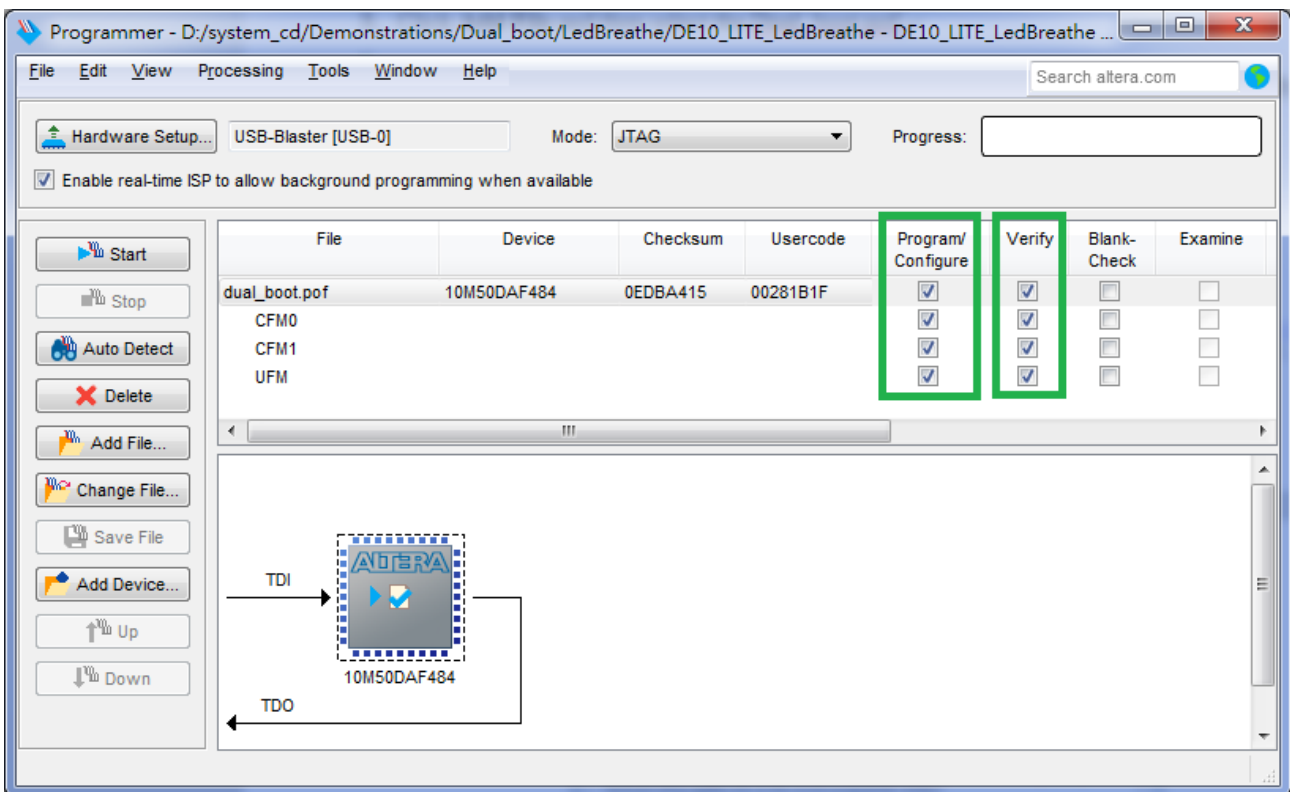

Figure 6-17 Programmer window with dual_boot.pof file