

# DATA SHEET

## THYRISTOR SURGE SUPPRESSORS

### MODEMS/LINE CARD

PXXXXSX series

RoHS compliant & Halogen free



Product specification— December 18, 2018 V.0



## Thyristor Surge Suppressors (TSS) Data Sheet

### Description

DO-214AA Thyristor solid state protection thyristor protect telecommunications equipment such as modems, line cards, fax machines, and other CPE.

P Series devices are used to enable equipment to meet various regulatory requirements including GR 1089, ITU K.20, K.21 and K.45, IEC 60950, UL 60950, and TIA-968 (formerly known as FCC Part 68).



### Features

Compared to surge suppression using other technologies, P Series devices offer absolute surge protection regardless of the surge current available and the rate of applied voltage (dv/dt). P Series devices:

- Cannot be damaged by voltage
- Eliminate hysteresis and heat dissipation typically found with clamping devices
- Eliminate voltage overshoot caused by fast-rising transients
- Are non-degenerative
- Will not fatigue
- Have low capacitance, making them ideal for high-speed transmission equipment
- Meets MSL level 1, per J-STD-020
- Safety certification: UL: E244458

### Electrical Parameters

Parameter	Definition
$V_{DRM}$	<b>Peak Off-state Voltage</b> – maximum voltage that can be applied while maintaining off state
$V_S$	<b>Switching Voltage</b> – maximum voltage prior to switching to on state
$V_T$	<b>On-state Voltage</b> – maximum voltage measured at rated on-state current
$I_{DRM}$	<b>Leakage Current</b> – maximum peak off-state current measured at $V_{DRM}$
$I_S$	<b>Switching Current</b> – maximum current required to switch to on state
$I_T$	<b>On-state Current</b> – maximum rated continuous on-state current
$I_H$	<b>Holding Current</b> – minimum current required to maintain on state
$C_O$	<b>Off-state Capacitance</b> – typical capacitance measured in off state
$V_{PP}$	<b>Peak Pulse Voltage</b> – maximum rated peak impulse voltage
$I_{PP}$	<b>Peak Pulse Current</b> – maximum rated peak impulse current

## THYRISTOR SURGE SUPPRESSORS PXXXXSX

## Electrical Characteristics

Part Number	$V_{DRM}$ (V)	$V_S$ (V)	$V_T$ (V)	$I_{DRM}$ ( $\mu$ A)	$I_S$ (mA)	$I_T$ (A)	$I_H$ (mA)	$C_O$ (pF)	$V_{PP}$ 10/700 $\mu$ s (V)	$I_{PP}$ 10/1000 $\mu$ s (A)	Marking
P0080SA	6	25	4	5	800	2.2	50	50	2000	45	P008A
P0080SB	6	25	4	5	800	2.2	50	70	4000	80	P008B
P0080SC	6	25	4	5	800	2.2	50	100	6000	100	P008C
P0300SA	25	40	4	5	800	2.2	50	70	2000	45	P03A
P0300SB	25	40	4	5	800	2.2	50	70	4000	80	P03B
P0300SC	25	40	4	5	800	2.2	50	100	6000	100	P03C
P0640SA	58	77	4	5	800	2.2	150	50	2000	45	P06A
P0640SB	58	77	4	5	800	2.2	150	60	4000	80	P06B
P0640SC	58	77	4	5	800	2.2	150	100	6000	100	P06C
P0720SA	65	88	4	5	800	2.2	150	50	2000	45	P07A
P0720SB	65	88	4	5	800	2.2	150	60	4000	80	P07B
P0720SC	65	88	4	5	800	2.2	150	100	6000	100	P07C
P0900SA	75	98	4	5	800	2.2	150	45	2000	45	P09A
P0900SB	75	98	4	5	800	2.2	150	55	4000	80	P09B
P0900SC	75	98	4	5	800	2.2	150	90	6000	100	P09C
P1100SA	90	130	4	5	800	2.2	150	45	2000	45	P11A
P1100SB	90	130	4	5	800	2.2	150	55	4000	80	P11B
P1100SC	90	130	4	5	800	2.2	150	90	6000	100	P11C
P1300SA	120	160	4	5	800	2.2	150	45	2000	45	P13A
P1300SB	120	160	4	5	800	2.2	150	55	4000	80	P13B
P1300SC	120	160	4	5	800	2.2	150	90	6000	100	P13C
P1500SA	140	180	4	5	800	2.2	150	40	2000	45	P15A
P1500SB	140	180	4	5	800	2.2	150	60	4000	80	P15B
P1500SC	140	180	4	5	800	2.2	150	85	6000	100	P15C
P1800SA	170	220	4	5	800	2.2	150	40	2000	45	P18A
P1800SB	170	220	4	5	800	2.2	150	60	4000	80	P18B
P1800SC	170	220	4	5	800	2.2	150	85	6000	100	P18C
P2300SA	190	260	4	5	800	2.2	150	35	2000	45	P23A
P2300SB	190	260	4	5	800	2.2	150	55	4000	80	P23B
P2300SC	190	260	4	5	800	2.2	150	80	6000	100	P23C

### Electrical Characteristics

Part Number	V <sub>DRM</sub> (V)	V <sub>S</sub> (V)	V <sub>T</sub> (V)	I <sub>DRM</sub> (μA)	I <sub>S</sub> (mA)	I <sub>T</sub> (A)	I <sub>H</sub> (mA)	C <sub>O</sub> (pF)	V <sub>PP</sub> 10/700μs (V)	I <sub>PP</sub> 10/1000μs (A)	Marking
P2600SA	220	300	4	5	800	2.2	150	35	2000	45	P26A
P2600SB	220	300	4	5	800	2.2	150	50	4000	80	P26B
P2600SC	220	300	4	5	800	2.2	150	80	6000	100	P26C
P3100SA	275	350	4	5	800	2.2	150	30	2000	45	P31A
P3100SB	275	350	4	5	800	2.2	150	45	4000	80	P31B
P3100SC	275	350	4	5	800	2.2	150	65	6000	100	P31C
P3500SA	320	400	4	5	800	2.2	150	30	2000	45	P35A
P3500SB	320	400	4	5	800	2.2	150	40	4000	80	P35B
P3500SC	320	400	4	5	800	2.2	150	65	6000	100	P35C

**Notes:**

- All measurements are made at an ambient temperature of 25°C. I<sub>PP</sub> applies to -40°C through +85°C temperature range.
- Off-state capacitance(C<sub>O</sub>) is measured at 1 MHz with a 2V bias and is typical value.

### Thermal Considerations

Package DO-214AA/SMB	Symbol	Parameter	Value	Unit
	T <sub>J</sub>	Operating Junction Temperature	-40 to +150	°C
	T <sub>S</sub>	Storage Temperature Range	-40 to +150	°C
	R <sub>θJA</sub>	Junction to Ambient on printed circuit	90	°C/W

### Part Number Code and Marking

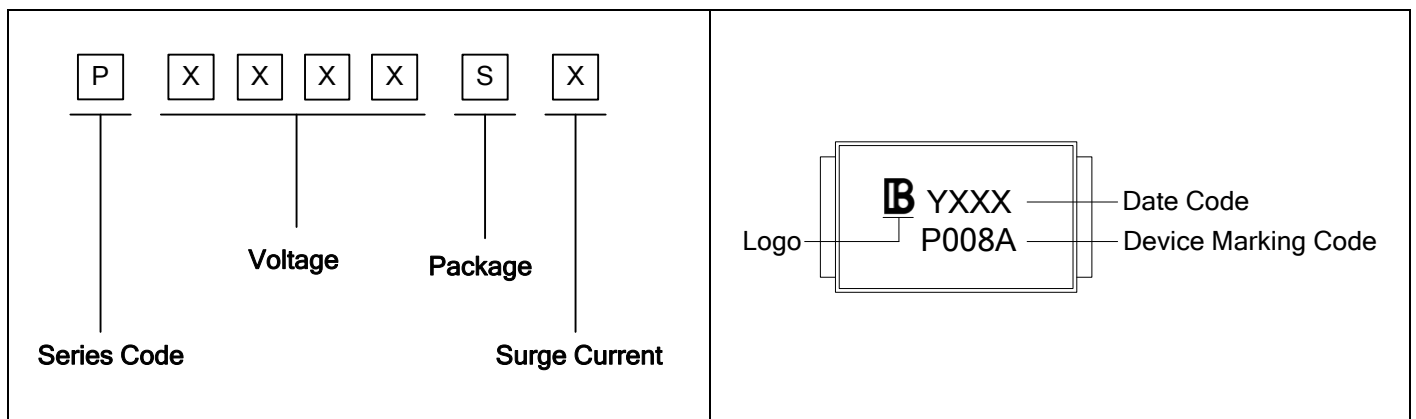

**Characteristics Curves**

Figure 1. V-I Characteristics

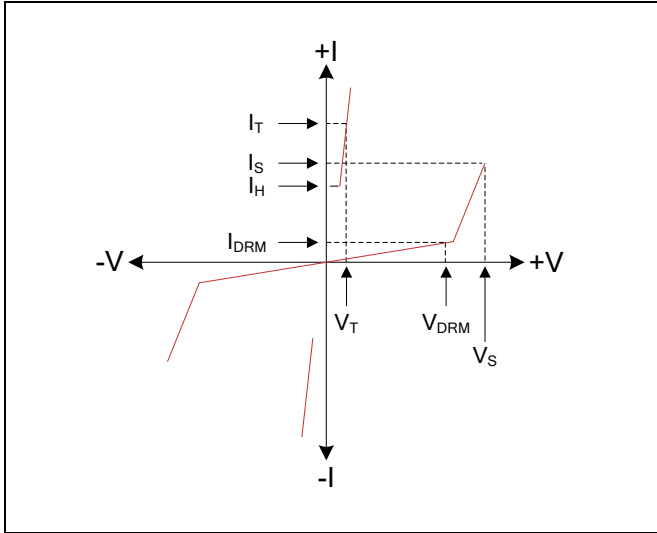

Figure 2.  $t_r \times t_d$  Pulse Wave-form

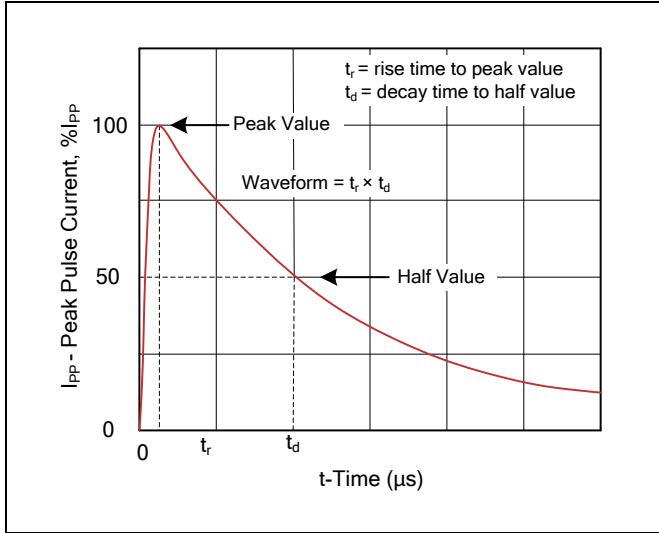

Figure 3. Normalized  $V_S$  Change versus Junction Temperature

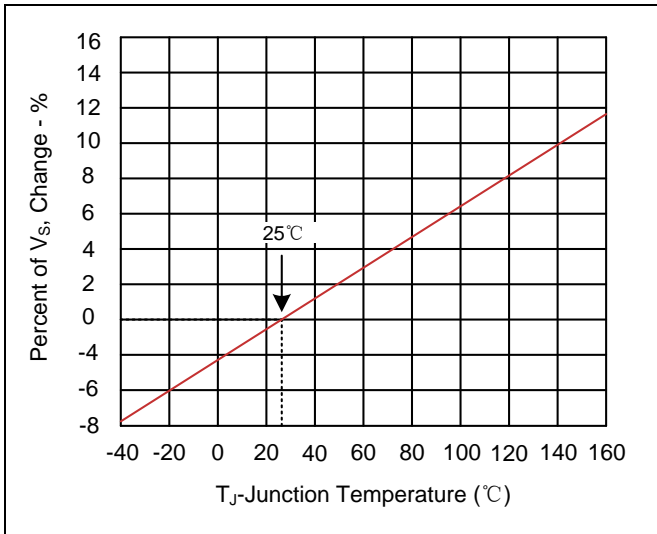
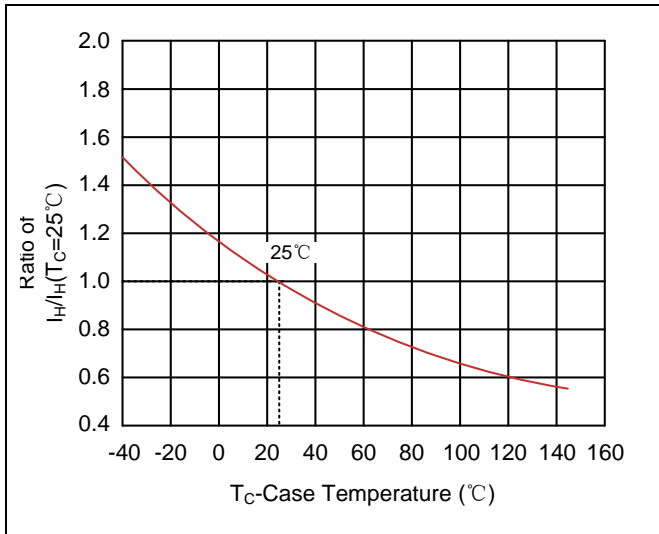
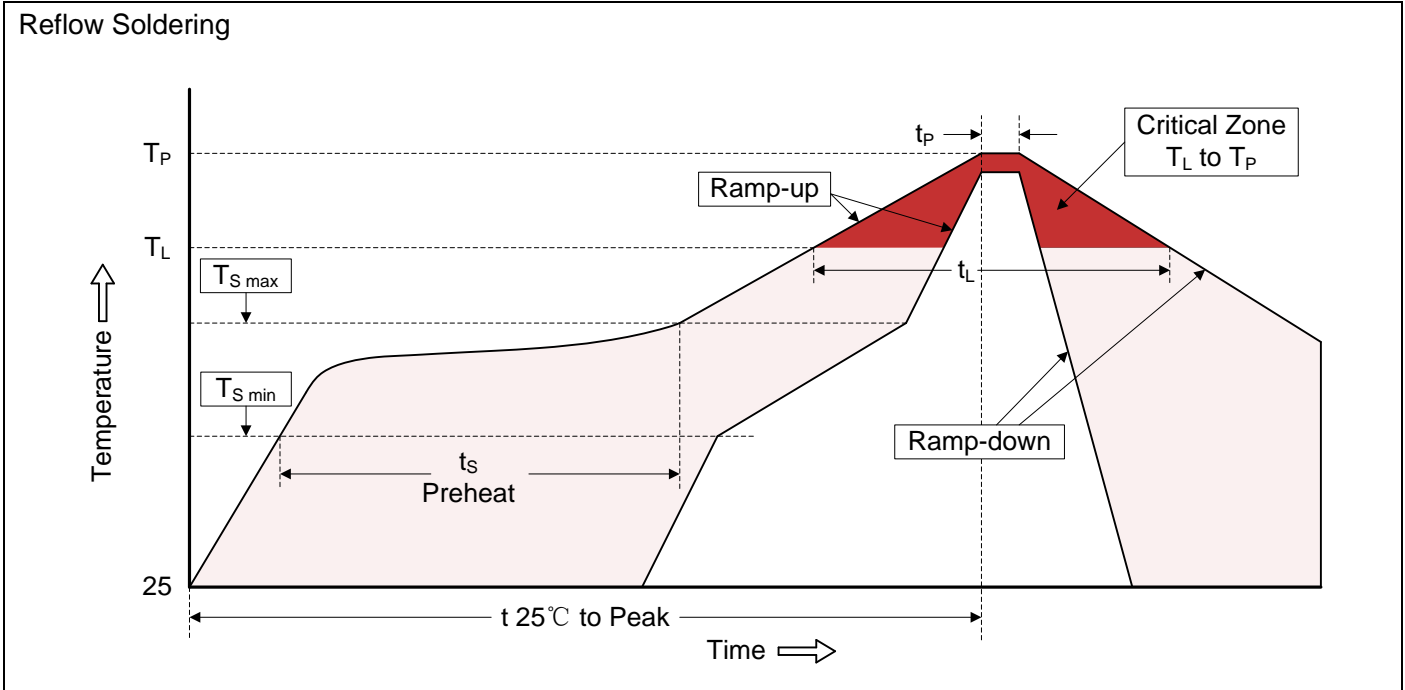

Figure 4. Normalized DC Holding Current versus Case Temperature



**Recommended Soldering Conditions**



**Recommended Conditions**

Profile Feature	Pb-Free Assembly
Average ramp-up rate ( $T_L$ to $T_P$ )	3°C/second max.
Preheat -Temperature Min ( $T_{S\ min}$ ) -Temperature Max ( $T_{S\ max}$ ) -Time (min to max) ( $t_s$ )	150°C 200°C 60-180 seconds
$T_{S\ max}$ to $T_L$ -Ramp-up Rate	3°C/second max.
Time maintained above: -Temperature ( $T_L$ ) -Time ( $t_L$ )	217°C 60-150 seconds
Peak Temperature ( $T_P$ )	260°C
Time within 5°C of actual Peak Temperature ( $t_p$ )	20-40 seconds
Ramp-down Rate	6°C/second max.
Time 25°C to Peak Temperature	8 minutes max.

**Dimensions (SMB/DO-214AA)**

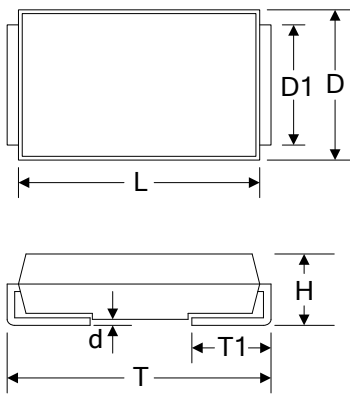
	Symbol	Millimeters		Inches	
		Min.	Max.	Min.	Max.
	L	4.22	4.70	0.166	0.185
	D	3.40	3.94	0.134	0.155
	D1	1.90	2.20	0.075	0.086
	T	5.21	5.59	0.205	0.220
	T1	0.91	1.42	0.036	0.056
	d	0.05	0.20	0.002	0.008
	H	1.95	2.40	0.077	0.095

**Packaging**

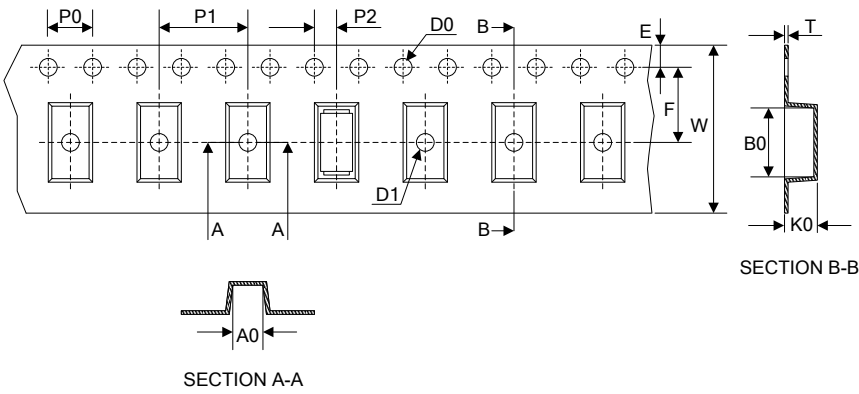
<p>Tape</p> 	Symbol	Dimension (mm)
	W	12.00±0.30
	P0	4.00±0.10
	P1	8.00±0.10
	P2	2.00±0.10
	D0	Φ1.55±0.05
	D1	Φ1.55±0.05
	E	1.75±0.10
	F	5.50±0.10
	A0	3.76±0.10
	B0	5.69±0.10
	K0	2.70±0.10
	T	0.25±0.10
<p>Reel</p>	D2	Φ330.0±2.0
	D3	Φ13.5±0.5
	H	2.5±0.5
	W1	16.0±1.0