

Pxxx0FNL 3kA SIDACtor® Series in TO-262M



Description

The Pxxx0FNL 3kA SIDACtor® Series in TO-262M package are bi-directional protection thyristor devices designed to be used in series with clamping device such as varistors or TVS diode for protecting AC power input lines.

This Series is ideal for use in outdoor LED lighting, CATV network, power supply and inverter applications.

Features and Benefits

- 3kA 8/20 surge rating
- Automotive grade AEC-Q101 qualified
- AC mains protection between L -N
- Low overshoot voltage
- Low on-state voltage
- Surge capability does not degrade after multiple events within its surge ratings
- Fails short circuit if surged in excess of its surge rating
- Fast response in nanoseconds
- Pb-free E3 means 2nd level interconnect is Pb-free and the terminal finish material is tin(Sn) (IPC/JEDEC J-STD-609A.01)
- RoHS-compliant and halogen-free
- Recognized to UL 497B as an Isolated Loop Circuit Protector

Agency Approvals

| Agency | Agency File Number |
|--------|--------------------|
| | E133083 |

Schematic Symbol



Electrical Characteristics

| Part Number | Marking | V_{DRM} @ $I_{DRM}=5\mu A$ | V_s @ $100V/\mu s$ | I_H | I_s | I_T | V_T @ $I_T=2.2 A$ | Capacitance @ 1MHz, 2V bias | |
|-------------|---------|---------------------------------|-------------------------|--------|--------|-------|------------------------|--------------------------------|--------|
| | | V min | V max | mA min | mA max | A max | V max | pF min | pF max |
| P0640FNL | P0640FN | 58 | 77 | 50 | 800 | 2.2 | 4 | 250 | 550 |
| P0720FNL | P0720FN | 65 | 88 | 50 | 800 | 2.2 | 4 | 250 | 550 |
| P0900FNL | P0900FN | 75 | 98 | 50 | 800 | 2.2 | 4 | 250 | 550 |
| P1100FNL | P1100FN | 90 | 130 | 50 | 800 | 2.2 | 4 | 250 | 450 |
| P1300FNL | P1300FN | 120 | 160 | 50 | 800 | 2.2 | 4 | 250 | 450 |
| P1500FNL | P1500FN | 140 | 180 | 50 | 800 | 2.2 | 4 | 250 | 450 |
| P1900FNL | P1900FN | 155 | 220 | 50 | 800 | 2.2 | 4 | 250 | 450 |
| P2300FNL | P2300FN | 180 | 260 | 50 | 800 | 2.2 | 4 | 250 | 450 |
| P2600FNL | P2600FN | 220 | 300 | 50 | 800 | 2.2 | 4 | 250 | 450 |
| P3100FNL | P3100FN | 275 | 350 | 50 | 800 | 2.2 | 4 | 250 | 450 |
| P3500FNL | P3500FN | 320 | 400 | 50 | 800 | 2.2 | 4 | 250 | 450 |
| P3800FNL | P3800FN | 350 | 430 | 50 | 800 | 2.2 | 4 | 250 | 450 |

Notes:

- Absolute maximum ratings measured at $T_A=25^\circ C$ (unless otherwise noted).
- Components are bi-directional (unless otherwise noted).

Surge Ratings

| Series | I_{PP} | I_{TSM} 50 / 60 Hz | di/dt |
|--------|---------------------------------------|----------------------|----------|
| | 1.2/50 ¹ 8/20 ² | | |
| | A min | A min | A/μs max |
| N | 3000 | 300 | 330 |

Notes:

- 1 Voltage waveform in μs
- 2 Current waveform in μs

- Peak pulse current rating (I_{pp}) is repetitive and guaranteed for the life of the product.

Thermal Considerations

| Symbol | Parameter | Value | Unit |
|-----------|---|-------------|------|
| T_J | Operating Junction Temperature Range | -55 to +125 | °C |
| T_S | Storage Temperature Range | -55 to +150 | °C |
| $R_{θJA}$ | Thermal Resistance: Junction to Ambient | 75 | °C/W |

V-I Characteristics

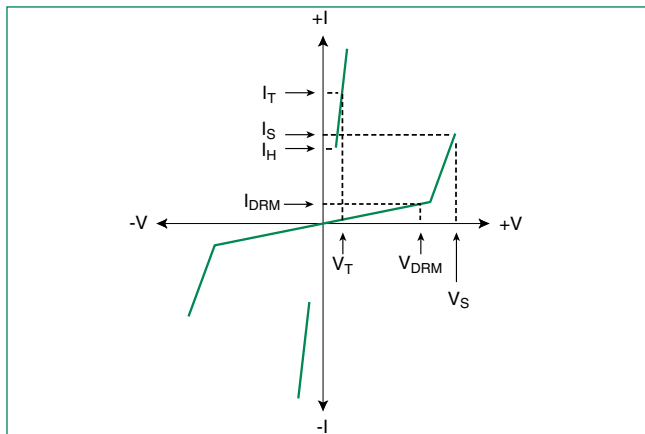

$t_r \times t_d$ Pulse Waveform

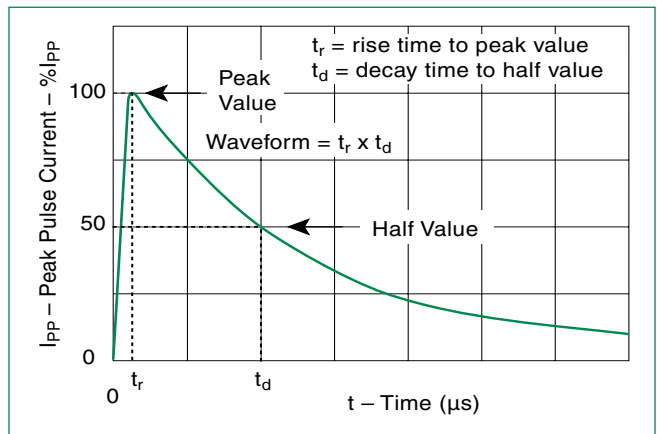

Normalized V_S Change vs. Junction Temperature

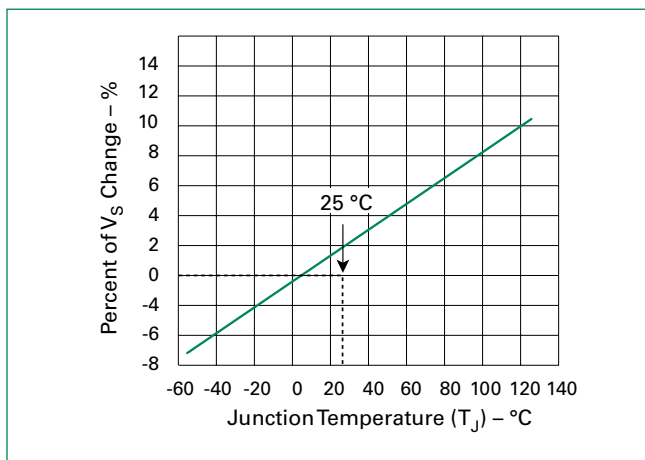

Normalized DC Holding Current vs. Case Temperature

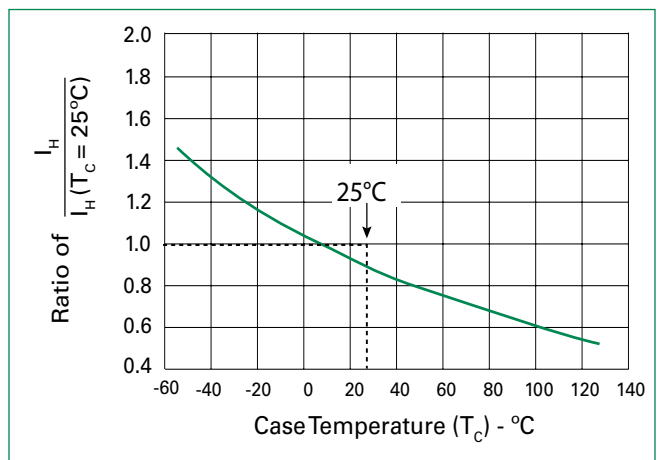

Wave Soldering Parameters

| | | |
|-----------------------------------|------------------------------------|-----------------|
| Pre Heat (depending on flux only) | - Temperature Min ($T_{s(min)}$) | +150°C |
| | - Temperature Max ($T_{s(max)}$) | +200°C |
| | - Time (Min to Max) (t_s) | 60-180 secs. |
| Solder Pot Temperature | | 245-265°C (Max) |
| Solder Dwell Time | | 2-3.5 sec. |
| Cooling | | -6°C/sec. (Max) |

Physical Specifications

| | |
|-----------------|---|
| Lead Material | Copper Alloy |
| Terminal Finish | 100% Matte-Tin Plated |
| Body Material | UL Recognized epoxy meeting flammability classification V-0 |

Part Numbering

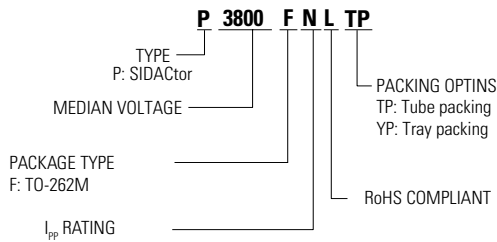

Environmental Specifications

| | |
|----------------------------|---|
| High Temp Voltage Blocking | 80% Rated V_{DRM} (V_{AC} Peak) T_{Jr} 1008 hrs. MIL-STD-750 (Method 1040) JEDEC, JESD22-A-101 |
| Temp Cycling | -55°C to +150°C, 1000cycles. JESD22-A104 |
| Biased Temp & Humidity | 80% Rated V_{DRM} up to a maximum of 100V, (+85°C) 85%RH, 1008 hrs. EIA/JEDEC, JESD22-A-101 |
| High Temp Storage | +150°C 1008 hrs. MIL-STD-750 (Method 1031) JEDEC, JESD22-A-101 |
| UHAST | 96 hours at $T_A=130°C/85\%RH$, JESD22A-118 |
| Resistance to Solder Heat | +260°C, 30 secs. MIL-STD-750 (Method 2031) |

Part Marking

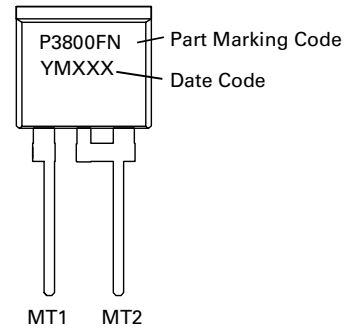

Dimensions - TO-262M (Isolated)

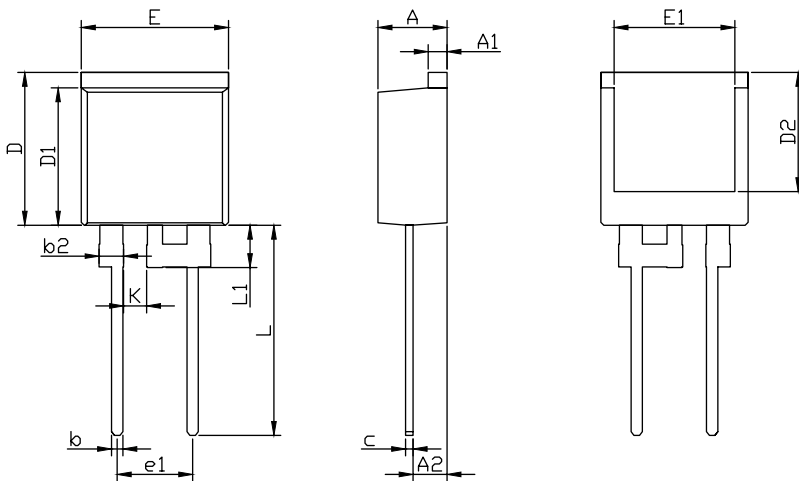

| Dimensions | Inches | | Millimeters | |
|------------|--------|-------|-------------|-------|
| | Min | Max | Min | Max |
| A | 0.178 | 0.188 | 4.52 | 4.78 |
| A1 | 0.045 | 0.060 | 1.14 | 1.52 |
| A2 | 0.080 | 0.115 | 2.03 | 2.92 |
| b | 0.025 | 0.035 | 0.64 | 0.89 |
| b2 | 0.060 | 0.080 | 1.52 | 2.03 |
| c | 0.018 | 0.024 | 0.46 | 0.61 |
| D | 0.394 | 0.434 | 10.01 | 11.03 |
| D1 | 0.345 | 0.385 | 8.75 | 9.77 |
| D2 | 0.310 | 0.350 | 7.86 | 8.88 |
| E | 0.380 | 0.420 | 9.65 | 10.67 |
| E1 | 0.302 | 0.342 | 7.66 | 8.68 |
| e1 | 0.190 | 0.210 | 4.82 | 5.32 |
| K | 0.046 | 0.066 | 1.16 | 1.67 |
| L | 0.530 | 0.580 | 13.46 | 14.72 |
| L1 | 0.105 | 0.130 | 2.66 | 3.30 |