

Pxxx0FNL 3kA SIDACtor® Series in TO-262M



Description

The Pxxx0FNL 3kA SIDACtor® Series in TO-262M package are bi-directional protection thyristor devices designed to be used in series with clamping device such as varistors or TVS diode for protecting AC power input lines.

This Series is ideal for use in outdoor LED lighting, CATV network, power supply and inverter applications.

Features and Benefits

- 3kA 8/20 surge rating
- Automotive grade AEC-Q101 qualified
- AC mains protection between L -N
- Low overshoot voltage
- Low on-state voltage
- Surge capability does not degrade after multiple events within its surge ratings
- Fails short circuit if surged in excess of its surge rating
- Fast response in nanoseconds
- Pb-free E3 means 2nd level interconnect is Pb-free and the terminal finish material is tin(Sn) (IPC/JEDEC J-STD-609A.01)
- RoHS-compliant and halogen-free
- Recognized to UL 497B as an Isolated Loop Circuit Protector

Agency Approvals

Agency	Agency File Number
	E133083

Schematic Symbol



Electrical Characteristics

Part Number	Marking	V_{DRM} @ $I_{DRM}=5\mu A$	V_s @ $100V/\mu s$	I_H	I_s	I_T	V_T @ $I_T=2.2 A$	Capacitance @ 1MHz, 2V bias	
		V min	V max	mA min	mA max	A max	V max	pF min	pF max
P0640FNL	P0640FN	58	77	50	800	2.2	4	250	550
P0720FNL	P0720FN	65	88	50	800	2.2	4	250	550
P0900FNL	P0900FN	75	98	50	800	2.2	4	250	550
P1100FNL	P1100FN	90	130	50	800	2.2	4	250	450
P1300FNL	P1300FN	120	160	50	800	2.2	4	250	450
P1500FNL	P1500FN	140	180	50	800	2.2	4	250	450
P1900FNL	P1900FN	155	220	50	800	2.2	4	250	450
P2300FNL	P2300FN	180	260	50	800	2.2	4	250	450
P2600FNL	P2600FN	220	300	50	800	2.2	4	250	450
P3100FNL	P3100FN	275	350	50	800	2.2	4	250	450
P3500FNL	P3500FN	320	400	50	800	2.2	4	250	450
P3800FNL	P3800FN	350	430	50	800	2.2	4	250	450

Notes:

- Absolute maximum ratings measured at $T_A=25^\circ C$ (unless otherwise noted).
- Components are bi-directional (unless otherwise noted).

Surge Ratings

Series	I_{PP}	I_{TSM} 50 / 60 Hz	di/dt
	1.2/50 ¹ 8/20 ²		
	A min	A min	A/μs max
N	3000	300	330

Notes:

- 1 Voltage waveform in μs
- 2 Current waveform in μs

- Peak pulse current rating (I_{pp}) is repetitive and guaranteed for the life of the product.

Thermal Considerations

Symbol	Parameter	Value	Unit
T_J	Operating Junction Temperature Range	-55 to +125	°C
T_S	Storage Temperature Range	-55 to +150	°C
$R_{θJA}$	Thermal Resistance: Junction to Ambient	75	°C/W

V-I Characteristics

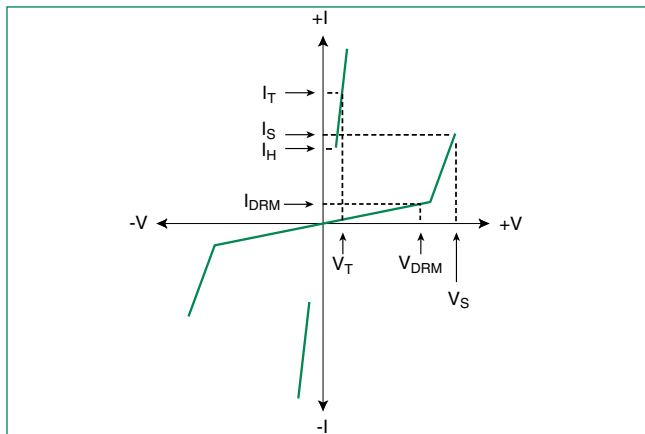

$t_r \times t_d$ Pulse Waveform

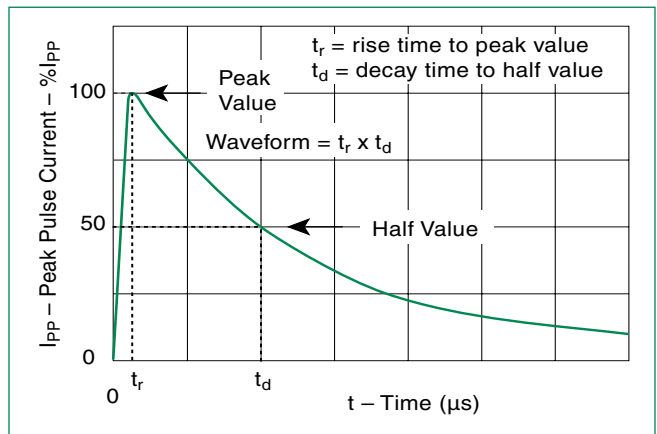

Normalized V_S Change vs. Junction Temperature

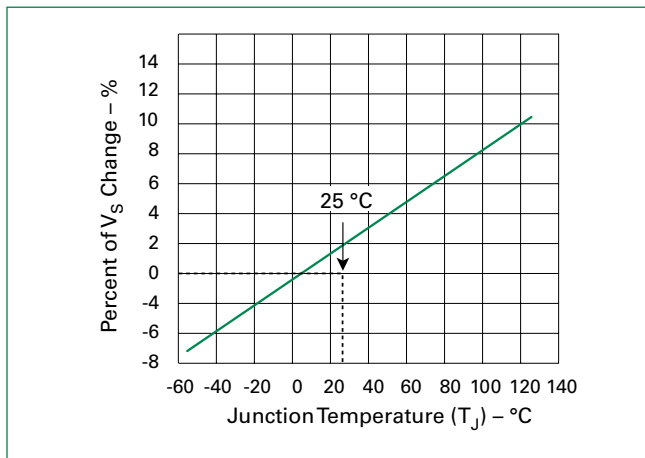

Normalized DC Holding Current vs. Case Temperature

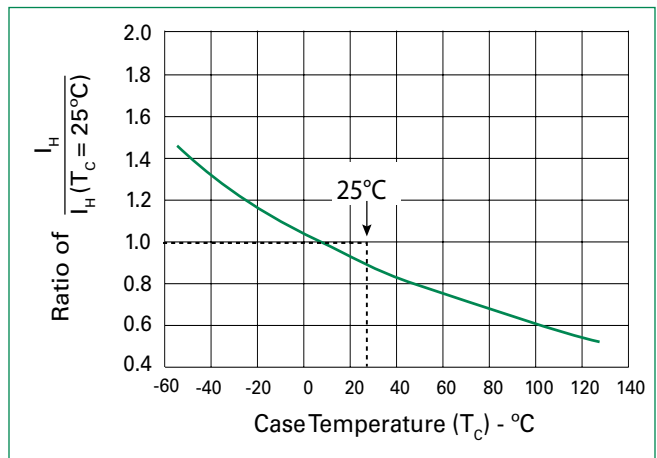

Wave Soldering Parameters

Pre Heat (depending on flux only)	- Temperature Min ($T_{s(min)}$)	+150°C
	- Temperature Max ($T_{s(max)}$)	+200°C
	- Time (Min to Max) (t_s)	60-180 secs.
Solder Pot Temperature		245-265°C (Max)
Solder Dwell Time		2-3.5 sec.
Cooling		-6°C/sec. (Max)

Physical Specifications

Lead Material	Copper Alloy
Terminal Finish	100% Matte-Tin Plated
Body Material	UL Recognized epoxy meeting flammability classification V-0

Part Numbering

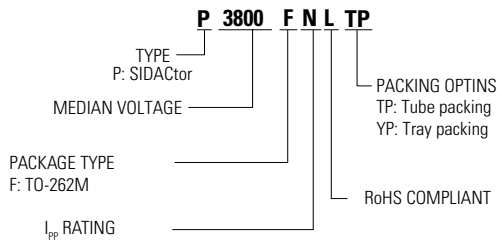

Environmental Specifications

High Temp Voltage Blocking	80% Rated V_{DRM} (V_{AC} Peak) T_J 1008 hrs. MIL-STD-750 (Method 1040) JEDEC, JESD22-A-101
Temp Cycling	-55°C to +150°C, 1000cycles. JESD22-A104
Biased Temp & Humidity	80% Rated V_{DRM} up to a maximum of 100V, (+85°C) 85%RH, 1008 hrs. EIA/JEDEC, JESD22-A-101
High Temp Storage	+150°C 1008 hrs. MIL-STD-750 (Method 1031) JEDEC, JESD22-A-101
UHAST	96 hours at $T_A=130°C/85\%RH$, JESD22A-118
Resistance to Solder Heat	+260°C, 30 secs. MIL-STD-750 (Method 2031)

Part Marking

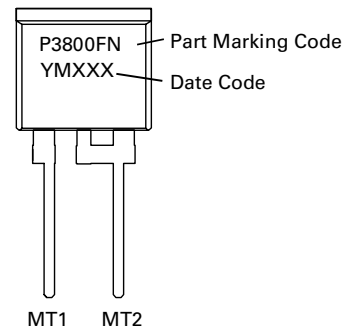

Dimensions - TO-262M (Isolated)

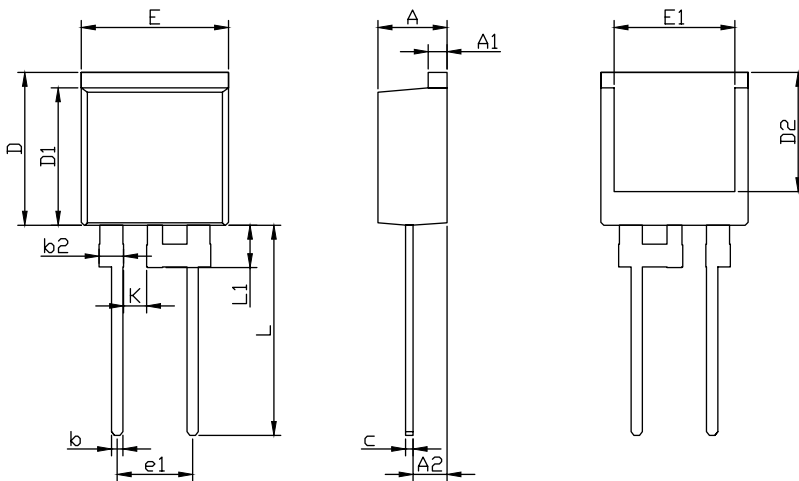

Dimensions	Inches		Millimeters	
	Min	Max	Min	Max
A	0.178	0.188	4.52	4.78
A1	0.045	0.060	1.14	1.52
A2	0.080	0.115	2.03	2.92
b	0.025	0.035	0.64	0.89
b2	0.060	0.080	1.52	2.03
c	0.018	0.024	0.46	0.61
D	0.394	0.434	10.01	11.03
D1	0.345	0.385	8.75	9.77
D2	0.310	0.350	7.86	8.88
E	0.380	0.420	9.65	10.67
E1	0.302	0.342	7.66	8.68
e1	0.190	0.210	4.82	5.32
K	0.046	0.066	1.16	1.67
L	0.530	0.580	13.46	14.72
L1	0.105	0.130	2.66	3.30