

Q2L Series - 3x3 QFN

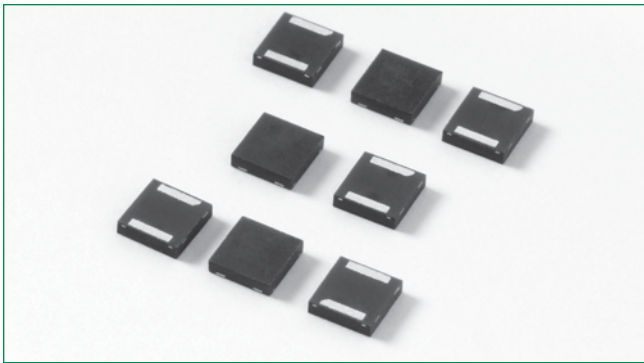

Description

Q2L Series 3x3 QFN are low capacitance SIDACtor® thyristors designed to protect high density broadband equipment from damaging overvoltage transients.

The series provides a low profile surface solution that enables broadband equipment to comply with global regulatory standards while limiting the impact to broadband signals and board space.

Agency Approvals

| Agency | Agency File Number |
|--------|--------------------|
| | E133083 |

Schematic Symbol

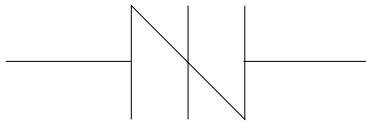

Features and Benefits

- Low voltage overshoot
- Low on-state voltage
- Low capacitance
- Does not degrade surge capability after multiple surge events within limit.
- Small footprint
- Fails short circuit when surged in excess of ratings
- RoHS Compliant and Halogen-Free
- Pb-free E3 means 2nd level interconnect is Pb-free and the terminal finish material is tin(Sn) (IPC/JEDEC J-STD-609A.01)
- Recognized to UL 497B as an Isolated Loop Circuit Protector

Additional Information



Datasheet



Resources



Samples

Applicable Global Standards

- TIA-968-A
- TIA-968-B
- ITU K.20/21/45 Enhanced Level*
- ITU K.20/21/45 Basic Level
- IEC 61000-4-5 2nd edition
- GR 1089 Inter-building*
- GR 1089 Intra-building
- YD/T 1082
- YD/T 993
- YD/T 950

* A/B-Rated parts require series resistance

Electrical Characteristics

| Part Number | Marking | V _{DRM} @ I _{DRM} = 5μA V min | V _S @ 100V/μs V max | I _H mA min | I _S mA max | I _T A max | V _T @ I _T = 2.2Amps V max | Capacitance @ 1MHz, 2V bias | |
|--------------|---------|---|--------------------------------------|--------------------------|--------------------------|-------------------------|---|--------------------------------|--------|
| | | | | | | | | pF Min | pF Max |
| P0080Q12ALRP | P-8A | 6 | 25 | 50 | 800 | 2.2 | 5 | 25 | 55 |
| P0300Q12ALRP | P03A | 25 | 40 | 50 | 800 | 2.2 | 5 | 15 | 35 |
| P0640Q12ALRP | P06A | 58 | 77 | 150 | 800 | 2.2 | 5 | 40 | 60 |
| P0720Q12ALRP | P07A | 65 | 88 | 150 | 800 | 2.2 | 5 | 40 | 60 |
| P0900Q12ALRP | P09A | 75 | 98 | 150 | 800 | 2.2 | 5 | 35 | 55 |
| P1100Q12ALRP | P11A | 90 | 130 | 150 | 800 | 2.2 | 5 | 30 | 50 |
| P1200Q12ALRP | P12A | 100 | 130 | 150 | 800 | 2.2 | 5 | 30 | 50 |
| P1300Q12ALRP | P13A | 120 | 160 | 150 | 800 | 2.2 | 5 | 25 | 45 |
| P1500Q12ALRP | P15A | 140 | 180 | 150 | 800 | 2.2 | 5 | 25 | 40 |
| P1800Q12ALRP | P18A | 170 | 220 | 150 | 800 | 2.2 | 5 | 25 | 35 |
| P2000Q12ALRP | P20A | 180 | 220 | 150 | 800 | 2.2 | 5 | 25 | 35 |
| P2300Q12ALRP | P23A | 190 | 260 | 150 | 800 | 2.2 | 5 | 25 | 35 |
| P2500Q12ALRP | P25A | 230 | 290 | 150 | 800 | 2.2 | 5 | 25 | 35 |
| P2600Q12ALRP | P26A | 220 | 300 | 150 | 800 | 2.2 | 5 | 25 | 35 |
| P3100Q12ALRP | P31A | 275 | 350 | 150 | 800 | 2.2 | 5 | 20 | 35 |
| P3500Q12ALRP | P35A | 320 | 450 | 150 | 800 | 2.2 | 5 | 20 | 30 |
| P0080Q12BLRP | P-8B | 6 | 25 | 50 | 800 | 2.2 | 5 | 25 | 55 |
| P0300Q12BLRP | P03B | 25 | 40 | 50 | 800 | 2.2 | 5 | 15 | 35 |
| P0640Q12BLRP | P06B | 58 | 77 | 150 | 800 | 2.2 | 5 | 40 | 60 |
| P0720Q12BLRP | P07B | 65 | 88 | 150 | 800 | 2.2 | 5 | 40 | 60 |
| P0900Q12BLRP | P09B | 75 | 98 | 150 | 800 | 2.2 | 5 | 35 | 55 |
| P1100Q12BLRP | P11B | 90 | 130 | 150 | 800 | 2.2 | 5 | 30 | 50 |
| P1200Q12BLRP | P12B | 100 | 130 | 150 | 800 | 2.2 | 5 | 30 | 50 |
| P1300Q12BLRP | P13B | 120 | 160 | 150 | 800 | 2.2 | 5 | 25 | 45 |
| P1500Q12BLRP | P15B | 140 | 180 | 150 | 800 | 2.2 | 5 | 25 | 40 |
| P1800Q12BLRP | P18B | 170 | 220 | 150 | 800 | 2.2 | 5 | 25 | 35 |
| P2000Q12BLRP | P20B | 180 | 220 | 150 | 800 | 2.2 | 5 | 25 | 35 |
| P2300Q12BLRP | P23B | 190 | 260 | 150 | 800 | 2.2 | 5 | 25 | 35 |
| P2500Q12BLRP | P25B | 230 | 290 | 150 | 800 | 2.2 | 5 | 25 | 35 |
| P2600Q12BLRP | P26B | 220 | 300 | 150 | 800 | 2.2 | 5 | 25 | 35 |
| P3100Q12BLRP | P31B | 275 | 350 | 150 | 800 | 2.2 | 5 | 20 | 35 |
| P3500Q12BLRP | P35B | 320 | 400 | 150 | 800 | 2.2 | 5 | 20 | 30 |

Notes:

- Absolute maximum ratings measured at T_A = 25°C (unless otherwise noted).
- Components are bi-directional.

Surge Ratings

| Series | I _{pp} | | | | | I _{TSM} | di/dt |
|--------|-----------------|-----------------|----------|----------|-----------|------------------|----------|
| | 2/10μs | 1.2/50μs/8/20μs | 10/160μs | 10/560μs | 10/1000μs | 50 / 60 Hz | |
| | A min | A min | A min | A min | A min | A min | A/μs max |
| A | 150 | 150 | 90 | 50 | 45 | 20 | 500 |
| B | 250 | 250 | 150 | 100 | 80 | 25 | 500 |

Notes:

- Peak pulse current rating (I_{pp}) is repetitive and guaranteed for the life of the product.
- I_{pp} ratings applicable over temperature range of -40°C to +85°C
- The component must initially be in thermal equilibrium with -40°C ≤ T_J ≤ +150°C

Thermal Considerations

| Package | Symbol | Parameter | Value | Unit |
|--|------------------|---|-------------|------|
| 3x3 QFN  | T _J | Operating Junction Temperature Range | -40 to +150 | °C |
| | T _S | Storage Temperature Range | -65 to +150 | °C |
| | R _{θJA} | Thermal Resistance: Junction to Ambient | 120 | °C/W |

V-I Characteristics

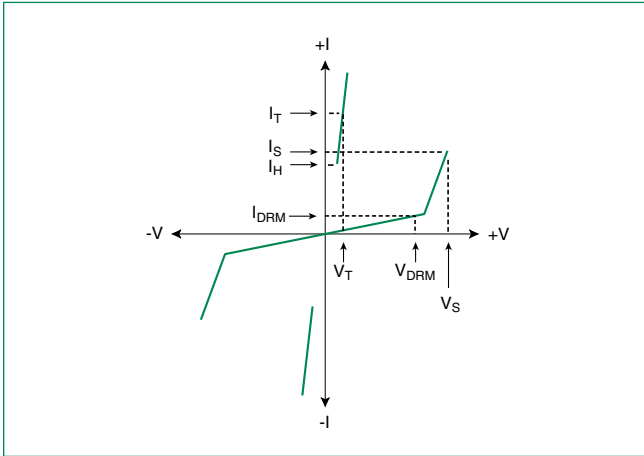

$t_r \times t_d$ Pulse Waveform

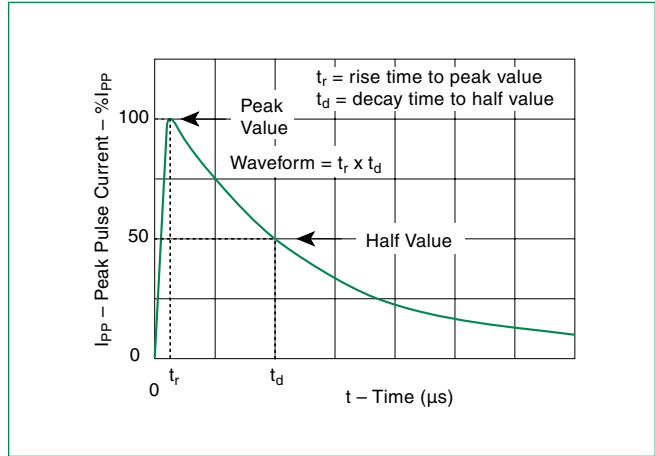

Normalized V_S Change vs. Junction Temperature

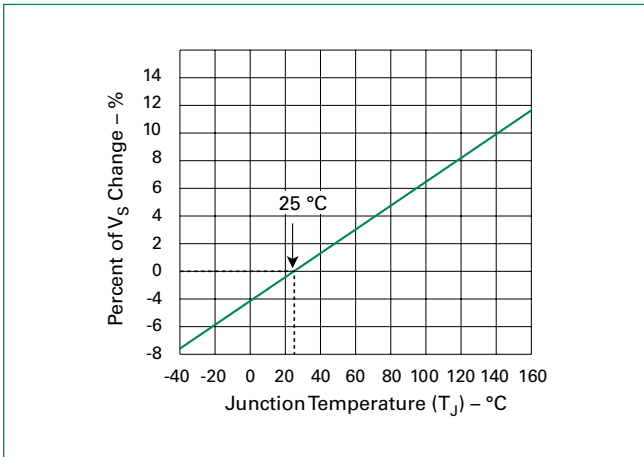

Normalized DC Holding Current vs. Case Temperature

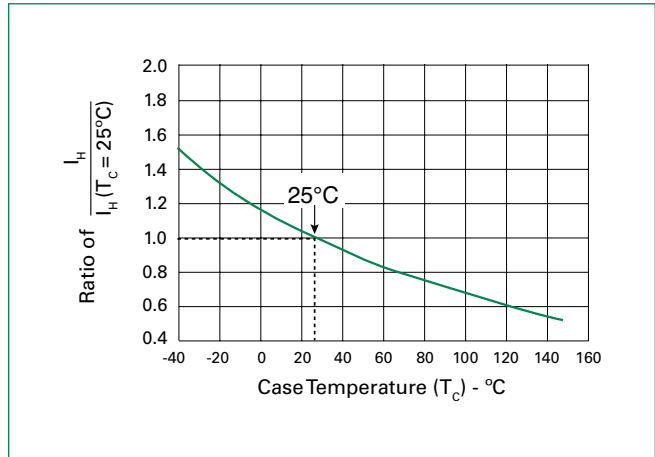

Soldering Parameters

| | | |
|--|------------------------------------|------------------|
| Reflow Condition | | Pb-Free assembly |
| Pre Heat | - Temperature Min ($T_{s(min)}$) | +150°C |
| | - Temperature Max ($T_{s(max)}$) | +200°C |
| | - Time (Min to Max) (t_s) | 60-180 secs. |
| Average ramp up rate (Liquidus Temp (T_L) to peak) | | 3°C/sec. Max. |
| $T_{S(max)}$ to T_L - Ramp-up Rate | | 3°C/sec. Max. |
| Reflow | - Temperature (T_L) (Liquidus) | +217°C |
| | - Temperature (t_t) | 60-150 secs. |
| Peak Temp (T_p) | | +260(+0/-5)°C |
| Time within 5°C of actual Peak Temp (t_p) | | 30 secs. Max. |
| Ramp-down Rate | | 6°C/sec. Max. |
| Time 25°C to Peak Temp (T_p) | | 8 min. Max. |
| Do not exceed | | +260°C |

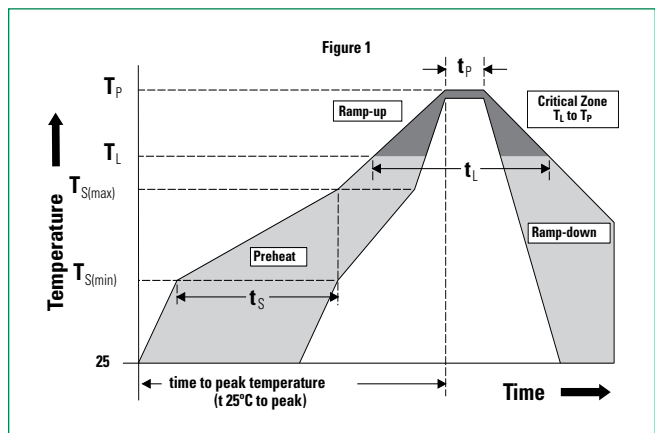

Physical Specifications

| | |
|------------------------|---|
| Lead Material | Copper Alloy |
| Terminal Finish | 100% Matte-Tin Plated |
| Body Material | UL Recognized epoxy meeting flammability classification V-0 |

Environmental Specifications

| | |
|-----------------------------------|---|
| High Temp Voltage Blocking | 80% Rated V_{DRM} ($V_{AC, Peak}$) +125°C or +150°C, 504 or 1008 hrs. MIL-STD-750 (Method 1040) JEDEC, JESD22-A-101 |
| Temp Cycling | -65°C to +150°C, 15 min. dwell, 10 up to 100 cycles. MIL-STD-750 (Method 1051) EIA/JEDEC, JESD22-A104 |
| Biased Temp & Humidity | 52 V_{DC} (+85°C) 85%RH, 504 up to 1008 hrs. EIA/JEDEC, JESD22-A-101 |
| High Temp Storage | +150°C 1008 hrs. MIL-STD-750 (Method 1031) JEDEC, JESD22-A-101 |
| Low Temp Storage | -65°C, 1008 hrs. |
| Thermal Shock | 0°C to +100°C, 5 min. dwell, 10 sec. transfer, 10 cycles. MIL-STD-750 (Method 1056) JEDEC, JESD22-A-106 |
| Resistance to Solder Heat | +260°C, 30 secs. MIL-STD-750 (Method 2031) |
| Moisture Sensitivity Level | 85%RH, +85°C, 168 hrs., 3 reflow cycles (+260°C Peak). JEDEC-J-STD-020, Level 1 |

Dimensions — 3x3 QFN

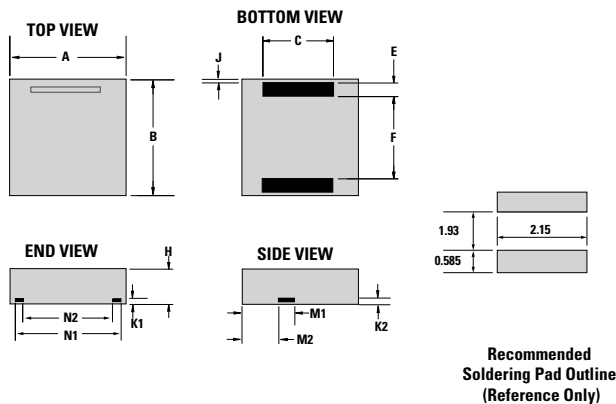

| Dimensions | Inches | | Millimeters | |
|------------|--------|-------|-------------|-------|
| | Min | Max | Min | Max |
| A | 0.114 | 0.122 | 2.900 | 3.100 |
| B | 0.114 | 0.122 | 2.900 | 3.100 |
| C | 0.075 | 0.083 | 1.900 | 2.100 |
| E | 0.011 | 0.019 | 0.285 | 0.485 |
| F | 0.076 | 0.084 | 1.930 | 2.130 |
| H | 0.035 | 0.043 | 0.900 | 1.100 |
| J | 0.000 | 0.008 | 0.000 | 0.200 |
| K1 | 0.004 | 0.012 | 0.100 | 0.300 |
| K2 | 0.004 | 0.012 | 0.100 | 0.300 |
| M1 | 0.056 | 0.064 | 1.430 | 1.630 |
| M2 | 0.038 | 0.046 | 0.970 | 1.170 |
| N1 | 0.096 | 0.104 | 2.440 | 2.640 |
| N2 | 0.082 | 0.090 | 2.080 | 2.280 |

Part Numbering

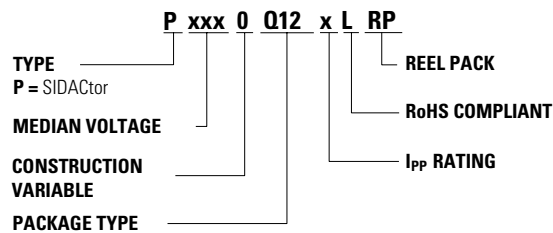

Part Marking

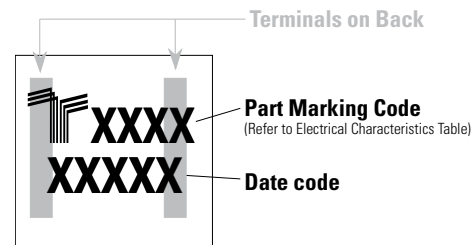

Packing Options

| Package Type | Description | Quantity | Added Suffix | Industry Standard |
|--------------|----------------------------|----------|--------------|-------------------|
| Q12 | 3x3 QFN Tape and Reel Pack | 5000 | RP | EIA-481-D |