

Slim Relay G2RV

The only truly industrial 6 mm relay

- Lockable test switch models now available.
- Large plug-in terminals for reliable connection.
- LED indicator and mechanical flag for status indication.
- Input type with gold plated contacts available.
- Transparent housing allows inspection of contact condition.
- Slim width to save space.
- Push-in terminals and accessories for easy wiring.
- Lloyd's approval (pending)

Test switch type

No test switch type

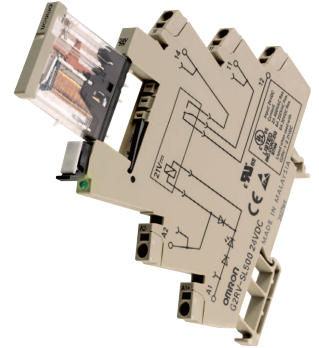
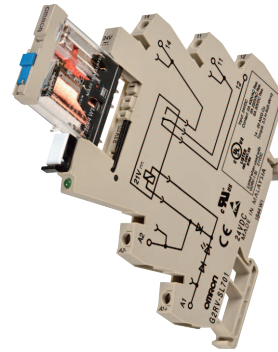

PATENTED



Features

■ Test switch operation

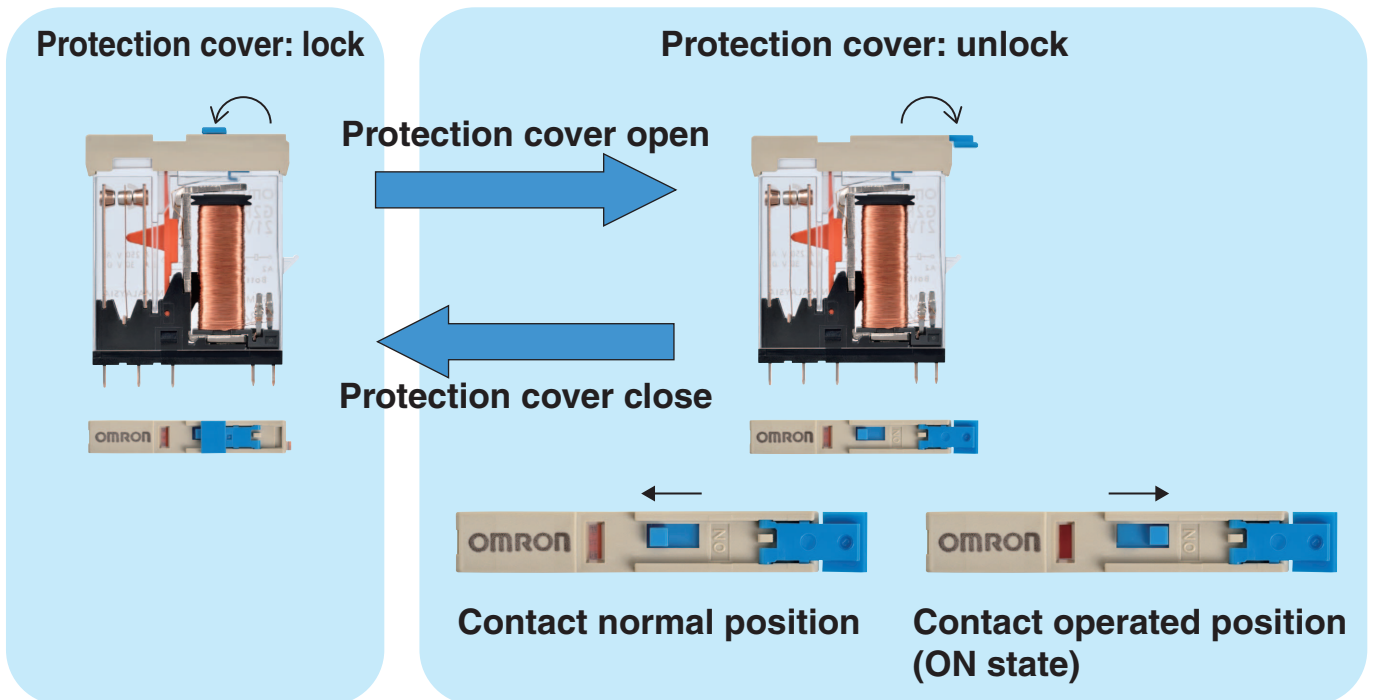

OMRON Lockable test switch can be used in this way:

When the protection cover (located directly over the test switch) is closed, the test switch is retained in normal position (OFF state) by the protection cover. After opening the protection cover, the test switch can be unlocked. The test switch can then be moved to the operated position (ON state). After using the test switch, move it to the normal position (OFF state) and close the protection cover to prevent unwanted operation of the test switch.

* Please check Precautions (Page. 17 : Precaution of test switch operation) when using test switch.

Application of test switch:

Example: Checking operation of Relays and sequence circuits.

Model Number Structure

Model Number Legend

G2RV-SL □ □ □ - □ - □
 1 2 3 4 5 6

1. Auxiliary Type Designation

SL: Slim relay and socket combination

2. Wire Connection

7: Screw terminals

5: Push-in terminals

3. Relay LED

0: Without LED

4. Relay Test switch

0: No test switch type

1: Test switch type

5. Contact form

AP: Input type

Blank: Standard type

6. Input Voltage

Note: LED indicator available on socket.

Ordering Information

List of Models

Classification		Enclosure rating	Input voltage	Type of connection	Test switch	Contact form (SPDT)	
						Standard type	Input type
Plug-in terminals	General-purpose	Unsealed	AC/DC	Screw terminals	No	G2RV-SL700	G2RV-SL700-AP
					Yes	G2RV-SL701	---
				Push-in terminals	No	G2RV-SL500	G2RV-SL500-AP
					Yes	G2RV-SL501	---

Relay and Socket Combinations

No test switch type

Input voltage	Contact form (SPDT)			
	Standard type (No test switch type)		Input type (No test switch type)	
	Screw terminals	Push-in terminals	Screw terminals	Push-in terminals
12 VDC	G2RV-SL700 12 VDC	G2RV-SL500 12 VDC	G2RV-SL700-AP 12 VDC	G2RV-SL500-AP 12 VDC
24 VDC	G2RV-SL700 24 VDC	G2RV-SL500 24 VDC	G2RV-SL700-AP 24 VDC	G2RV-SL500-AP 24 VDC
24 VAC/DC	G2RV-SL700 24 VAC/DC	G2RV-SL500 24 VAC/DC	G2RV-SL700-AP 24 VAC/DC	G2RV-SL500-AP 24 VAC/DC
48 VAC/DC	G2RV-SL700 48 VAC/DC	G2RV-SL500 48 VAC/DC	G2RV-SL700-AP 48 VAC/DC	G2RV-SL500-AP 48 VAC/DC
110 VAC	G2RV-SL700 110 VAC	G2RV-SL500 110 VAC	G2RV-SL700-AP 110 VAC	G2RV-SL500-AP 110 VAC
230 VAC	G2RV-SL700 230 VAC	G2RV-SL500 230 VAC	G2RV-SL700-AP 230 VAC	G2RV-SL500-AP 230 VAC

Test switch type

Input voltage	Contact form (SPDT)			
	Standard type (Test switch type)		Input type (Test switch type)	
	Screw terminals	Push-in terminals	Screw terminals	Push-in terminals
24 VDC	G2RV-SL701 24 VDC	G2RV-SL501 24 VDC	---	---
24 VAC/DC	G2RV-SL701 24 VAC/DC	G2RV-SL501 24 VAC/DC	---	---

Specifications

Input Ratings

Rated voltage	Rated current ^{*1}			Must operate voltage	Must release voltage	Power consumption		Input voltage
	AC		DC			% of rated voltage	AC (VA) Approx.	
	50 Hz	60 Hz		% of rated voltage				
12 VDC	---	---	27.2 mA	80%	10%	---	300 mW	±10%
24 VDC	---	---	13.3 mA			---	300 mW	
24 VAC/DC	21.1 mA	22.5 mA	13.0 mA			0.5 VA	300 mW	
48 VAC/DC	8.5 mA	9.0 mA	5.2 mA			0.4 VA	250 mW	
110 VAC	7.1 mA	7.5 mA	---			0.8 VA	---	
230 VAC	7.3 mA	7.9 mA	---			1.7 VA	---	

*1) Rated currents are measured at 23 degrees Celsius (ambient)

Contact Ratings

Item	Standard type (G2RV-SL700, 500, 701, 501)		Input type (G2RV-SL700-AP, 500-AP) ^{*2}
Number of poles	1 pole		
Load	Resistive load (cosφ = 1)	Inductive load (cosφ = 0.4, L/R = 7 ms)	Resistive load (cosφ = 1)
Rated load	6 A at 250 VAC; 6 A at 30 VDC	2.5 A at 250 VAC; 2 A at 30 VDC	50 mA at 30 VAC; 50 mA at 36 VDC
Rated carry current	6 A		50 mA
Max. switching voltage	400 VAC, 125 VDC		30 VAC, 36 VDC
Max. switching current	6 A		50 mA
Max. switching power	1,500 VA 180 W	500 VA 60 W	---
Failure rate (reference value) ^{*1}	10 mA at 5 VDC (P level)		1 mA at 100 mVDC (P level)

*1) P level: $\lambda_{60} = 0.1 \times 10^{-6}/\text{operation}$

*2) If a gold layer is destroyed, contact ratings of standard type are applicable.

Characteristics

Item	Standard type (G2RV-SL700, 500, 701, 501)	Input type (G2RV-SL700-AP, 500-AP)
Contact resistance	100 mΩ max.	
Operate (set) time	20 ms max.	
Release time	40 ms max.	
Max. operating frequency	Mechanical: 18,000 operations/hr Electrical: 1,800 operations/hr (under rated load)	
Insulation resistance	1,000 MΩ min. (at 500 VDC)	
Dielectric strength	4,000 VAC, 50/60 Hz for 1 min between coil and contacts*; 1,000 VAC, 50/60 Hz for 1 min between contacts of same polarity	
Vibration resistance	Destruction: 10 to 55 to 10 Hz, 0.50 mm single amplitude (1.0 mm double amplitude) Malfunction: 10 to 55 to 10 Hz, 0.50 mm single amplitude (1.0 mm double amplitude)	
Shock resistance	Destruction: 1,000 m/s ² Malfunction: 200 m/s ² when energized; 100 m/s ² when not energized	
Endurance	Mechanical: 5,000,000 operations min. Electrical: 100,000 Typical; NO 70,000 operations min. ; NC 50,000 operations min.	Mechanical: 5,000,000 operations min. Electrical: 5,000,000 operations min.
Ambient temperature	Operating: -40°C to 55°C (with no icing or condensation)	
Ambient humidity	Operating: 5% to 85%	
Weight	Approx. 35 g	
Overvoltage category	III	
Pollution degree	2	
Contact material	AgSnIn	AgSnIn + Gold Plating
Creepage distance	7.0 mm	
Clearance distance	5.5 mm	

Note: Values in the above table are the initial values.

■ Approved Standards

UL 508 (File No. E41643)

Model	Contact form	Coil ratings	Contact ratings	Operations
G2RV-SL Series	SPDT	12 to 48 VDC 24 to 230 VAC	250 VAC 6 A (Resistive Load) 30 VDC 6 A (Resistive Load) 400 VAC 2 A (Resistive Load)	6,000

IEC/VDE (EN 61810)

Contact form	Coil ratings	Contact ratings	Operations
SPDT	12, 24 VDC 24, 48 VAC/DC 110, 230 VAC	250 VAC 6 A (Resistive Load) 30 VDC 6 A (Resistive Load) 400 VAC 2 A (Resistive Load)	50,000 50,000 6,000

Engineering Data

■ Endurance

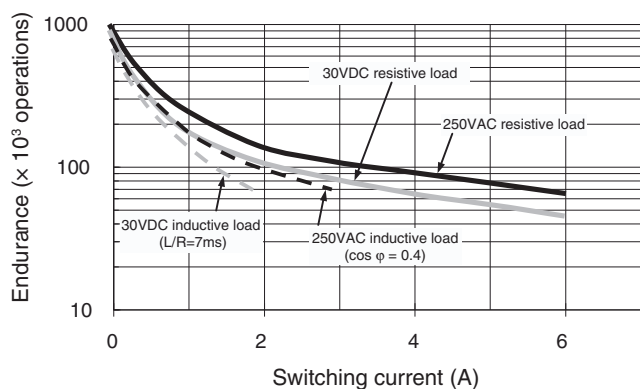

Switching capacity of DC resistive load

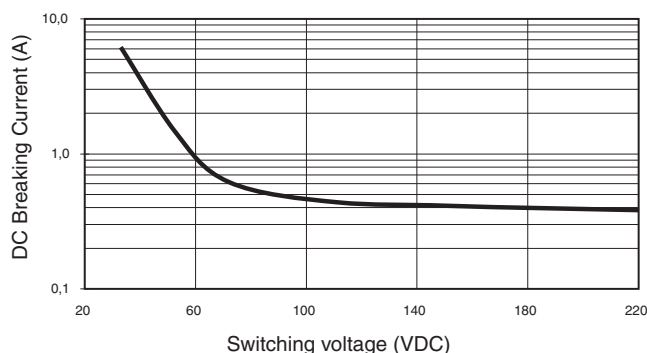

Typical Operating and Release Time

Model number	Operating time (typical)	Release time (typical)
G2RV-SL7□□/5□□ DC12	5 ~ 7 ms	5 ~ 8 ms
G2RV-SL7□□/5□□ DC24	5 ~ 7 ms	6 ~ 9 ms
G2RV-SL7□□/5□□ AC/DC24	5 ~ 7 ms	17 ~ 22 ms
G2RV-SL7□□/5□□ AC/DC48	5 ~ 7 ms	22 ~ 30 ms
G2RV-SL7□□/5□□ AC110	12 ~ 15 ms	22 ~ 30 ms
G2RV-SL7□□/5□□ AC230	12 ~ 15 ms	22 ~ 30 ms

Accessories

■ PLC Interface P2RVC-8-□-F

Contact form	Relay	PLC Interface
Standard type	G2RV-SL70□ series	P2RVC-8-O-F
Input type	G2RV-SL700-AP series	P2RVC-8-I-F

P2RVC-8-O-F (for G2RV-SL70□ series only)

List of Models

Model number	Description	Connection
P2RVC-8-O-F	PLC Output Interface for 8x G2RV-SL70□-series PNP - type	Ribbon cable connector 10 Pole, IEC603/1

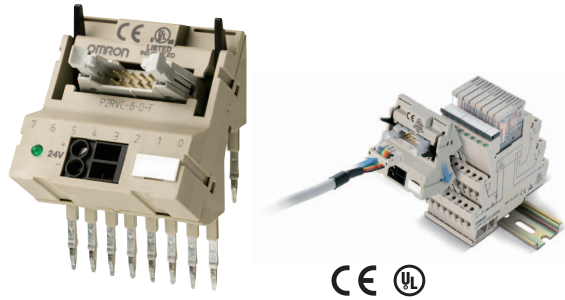

Specifications

Input	Rated voltage	30 VAC/VDC max.
	Current capacity	0.5 A per channel 2.0 A total current, power supply terminal
Characteristics	Ambient temperature	Operating: 0 to 55°C Storage: -20 to 85°C
	Overvoltage category	III
	Pollution degree	2

Electrical schematic P2RVC-8-O-F

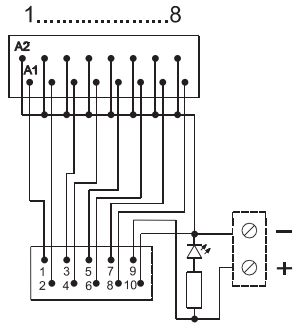

P2RVC-8-I-F (for G2RV-SL700-AP series only)

List of Models

Model number	Description	Connection
P2RVC-8-I-F	PLC Output Interface for 8x G2RV-SL700-series PNP - type	Ribbon cable connector 10 Pole, IEC603/1

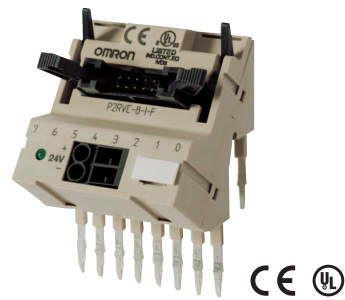

Specifications

Input	Rated voltage	30 VAC/VDC max.
	Current capacity	0.5 A per channel 2.0 A total current, power supply terminal
Characteristics	Ambient temperature	Operating: 0 to 55°C Storage: -20 to 85°C
	Overvoltage category	III
	Pollution degree	2

Electrical schematic P2RVC-8-I-F

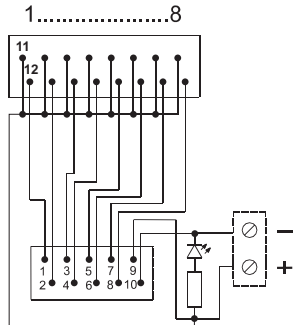

■ Cables for PLC Interface P2RVC-8-□-F

Cables selection List

Output	
Model number	To be used for (combined with P2RVC-8-O-F)
P2RV-4-100C	CJ1W-OD232/OD262
P2RV-4-200C	CJ1W-OD232/OD262
P2RV-4-300C	CJ1W-OD232/OD262
P2RV-4-500C	CJ1W-OD232/OD262
P2RV-A100C	Universal (stranded wires)
P2RV-A200C	Universal (stranded wires)
P2RV-A300C	Universal (stranded wires)
P2RV-A500C	Universal (stranded wires)
P2RV-A050C-OMR GRT1	GRT1-OD8(G)-1
P2RV-A100C-OMR GRT1	GRT1-OD8(G)-1
P2RV-A050C-OMR NX	NX-OD4256
P2RV-A100C-OMR NX	NX-OD4256
P2RV-200C-SIM S7/300	6ES7 322-1BL00-0AA0, 32DO
P2RV-250C-SIM S7/300	6ES7 322-1BL00-0AA0, 32DO
P2RV-300C-SIM S7/300	6ES7 322-1BL00-0AA0, 32DO
P2RV-500C-SIM S7/300	6ES7 322-1BL00-0AA0, 32DO
P2RV-200C-SIM S7/400	6ES7422-1BL00-0AA0 & 6ES7422-7BL00-0AB0, 32DO
P2RV-250C-SIM S7/400	6ES7422-1BL00-0AA0 & 6ES7422-7BL00-0AB0, 32DO
P2RV-300C-SIM S7/400	6ES7422-1BL00-0AA0 & 6ES7422-7BL00-0AB0, 32DO
P2RV-500C-SIM S7/400	6ES7422-1BL00-0AA0 & 6ES7422-7BL00-0AB0, 32DO

Input	
Model number	To be used for (combined with P2RVC-8-I-F)
P2RV-4-100IFC	CJ1W-ID231/ID233/ID261
P2RV-4-100IMC	CJ1W-ID233/ID262
P2RV-4-200IFC	CJ1W-ID231/ID233/ID261
P2RV-4-200IMC	CJ1W-ID233/ID262
P2RV-4-300IFC	CJ1W-ID231/ID233/ID261
P2RV-4-300IMC	CJ1W-ID233/ID262
P2RV-4-500IFC	CJ1W-ID231/ID233/ID261
P2RV-4-500IMC	CJ1W-ID233/ID262
P2RV-A100C	Universal (stranded wires)
P2RV-A200C	Universal (stranded wires)
P2RV-A300C	Universal (stranded wires)
P2RV-A500C	Universal (stranded wires)
P2RV-A050IC-OMR GRT1	GRT1-ID8-1
P2RV-A100IC-OMR GRT1	GRT1-ID8-1
P2RV-A050IC-OMR NX	NX-ID4442
P2RV-A100IC-OMR NX	NX-ID4442
P2RV-200C-SIM S7/300	6ES7 321-1BL00-0AA0, 32DI
P2RV-250C-SIM S7/300	6ES7 321-1BL00-0AA0, 32DI
P2RV-300C-SIM S7/300	6ES7 321-1BL00-0AA0, 32DI
P2RV-500C-SIM S7/300	6ES7 321-1BL00-0AA0, 32DI
P2RV-200C-SIM S7/400	6ES7421-1BL00-0AA0 & 6ES7421-1BL01-0AA0, 32DI
P2RV-250C-SIM S7/400	6ES7421-1BL00-0AA0 & 6ES7421-1BL01-0AA0, 32DI
P2RV-300C-SIM S7/400	6ES7421-1BL00-0AA0 & 6ES7421-1BL01-0AA0, 32DI
P2RV-500C-SIM S7/400	6ES7421-1BL00-0AA0 & 6ES7421-1BL01-0AA0, 32DI

P2RV-4-□□□C

P2RV-4-□□□IMC

P2RV-4-□□□IFC

Cable to connect CJ1 to 4 × P2RVC-8-□-F

List of Models

I/O	Model number	Cable length	Interface unit	PLC Connection	Connectors
Output	P2RV-4-100C	1.0 m	P2RVC-8-O-F × 4	OMRON PLC CJ1 Series: MIL	MIL40 - MIL10 × 4
	P2RV-4-200C	2.0 m			
	P2RV-4-300C	3.0 m			
	P2RV-4-500C	5.0 m			
Input	P2RV-4-100IMC	1.0 m	P2RVC-8-I-F × 4	OMRON PLC CJ1 Series: MIL	MIL40 - MIL10 × 4
	P2RV-4-200IMC	2.0 m			
	P2RV-4-300IMC	3.0 m			
	P2RV-4-500IMC	5.0 m			
Input	P2RV-4-100IFC	1.0 m	P2RVC-8-I-F × 4	OMRON PLC CJ1 Series: Fujitsu	FCN40 - MIL10 × 4
	P2RV-4-200IFC	2.0 m			
	P2RV-4-300IFC	3.0 m			
	P2RV-4-500IFC	5.0 m			

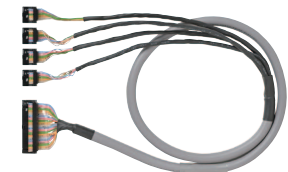

P2RV-4-□□□C/P2RV-4-□□□IMC



P2RV-4-□□□IFC

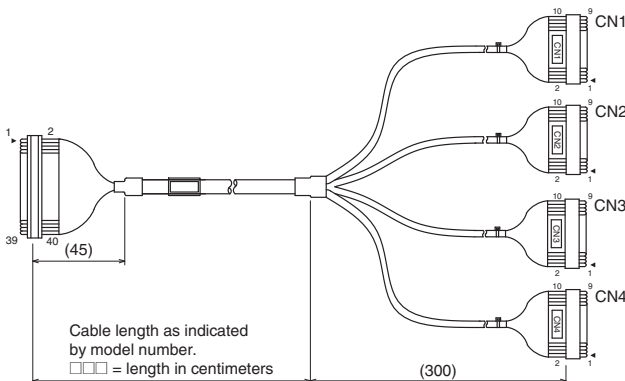

P2RV-4-□□□C/P2RV-4-□□□IMC

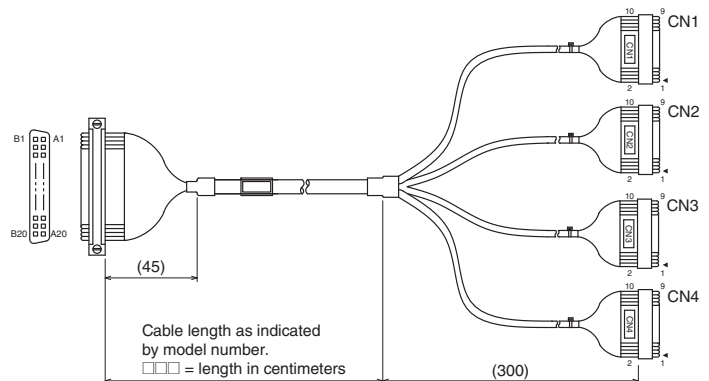

P2RV-4-□□□IFC

4 x 10 pole IDC mounting to 4 x P2RVC-8-□-F

P2RV-4-□□□C

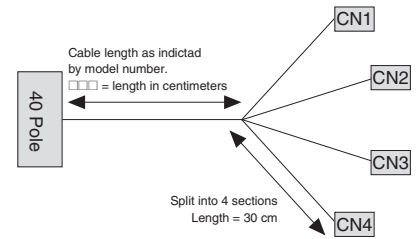
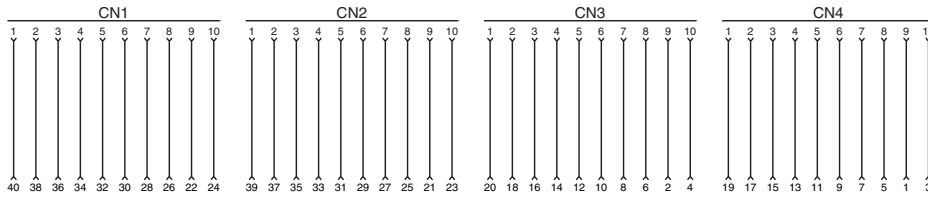

P2RV-4-□□□IMC

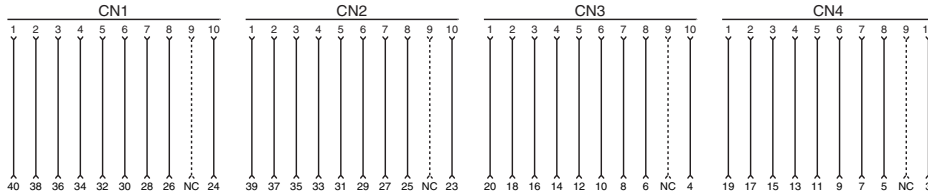

P2RV-4-□□□IFC

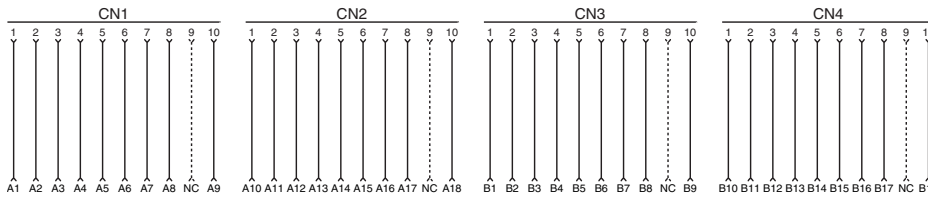

40 pole IDC mounting to Omron PLC CJ1-OD232

Technical data

Control line	AWG28/0.08 mm ² , tin-plated copper
Diameter cable	10.7 mm (one end splits into 4 sections: A, B, C, D)
Operating voltage	60 VDC
Continuous current per signal wire	0.5 A
Max. total current, 4 bytes, each	1.0 A
Test voltage	0.5 KV, 50 Hz, 1 min
Operating temperature range	-20°C to +50°C

P2RV-A□□□C

Cable, single sided 10 pole IDC connector, to connect to P2RVC-8-□-F

List of Models

I/O	Model number	Cable length	Interface unit	PLC interface	Connectors
Universal (Output/ Input)	P2RV-A100C	1.0 m	P2RVC-8-□-F	-	MIL10 - No connector
	P2RV-A200C	2.0 m			
	P2RV-A300C	3.0 m			
	P2RV-A500C	5.0 m			

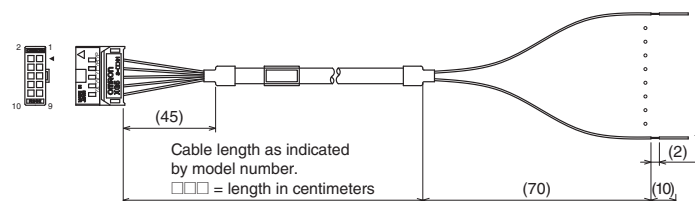
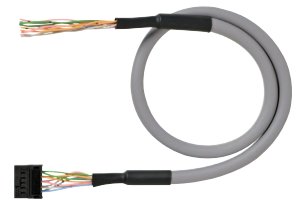

10 pole IDC mounting to P2RVC-8-□-F

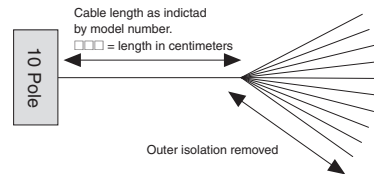

Technical data

Control line	AWG26/0.14 mm ² , tin-plated copper
Diameter cable	7.6 mm
Operating voltage	60 VDC
Continuous current per signal wire	0.5 A
Max. total current	1.0 A
Test voltage	0.5 KV, 50 Hz, 1 min
Operating temperature range	-20°C to +50°C

P2RV-A□□□C-OMR GRT1

P2RV-A□□□IC-OMR GRT1

List of Models

I/O	Model number	Cable length	Interface unit	PLC interface	Connectors
Output	P2RV-A050C-OMR GRT1	0.5 m	P2RVC-8-O-F	OMRON Smart slice I/O module GRT1 Series GRT1-OD8(G)-1	XW7E 12pole - MIL10
	P2RV-A100C-OMR GRT1	1.0 m			
Input	P2RV-A050IC-OMR GRT1	0.5 m	P2RVC-8-I-F	OMRON Smart slice I/O module GRT1 Series GRT1-ID9(G)-1	XW7E 12pole - MIL10
	P2RV-A100IC-OMR GRT1	1.0 m			

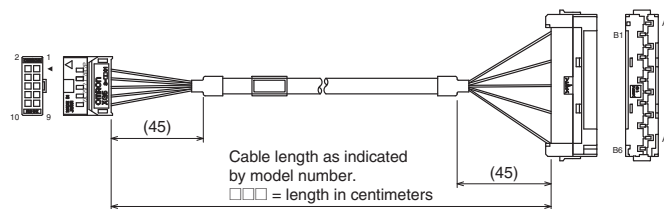
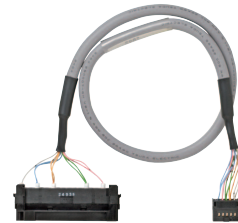

10 pole IDC mounting to P2RVC-8-□-F

P2RV-A□□□C-OMR GRT1

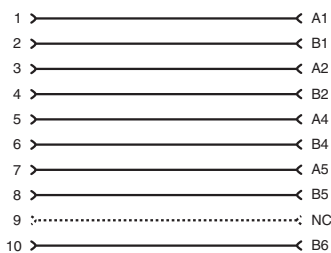

P2RV-A□□□IC-OMR GRT1

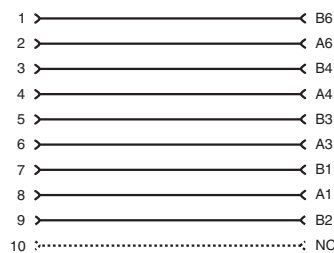

P2RV-A□□□C-OMR NX
P2RV-A□□□IC-OMR NX

List of Models

I/O	Model number	Cable length	Interface unit	PLC interface	Connectors
Output	P2RV-A050C-OMR GRT1	0.5 m	P2RVC-8-O-F	OMRON I/O module NX Series	XW7F 16pole-MIL10
	P2RV-A100C-OMR GRT1	1.0 m			
Input	P2RV-A050IC-OMR GRT1	0.5 m	P2RVC-8-I-F	OMRON I/O module NX Series	XW7F 16pole-MIL10
	P2RV-A100IC-OMR GRT1	1.0 m			

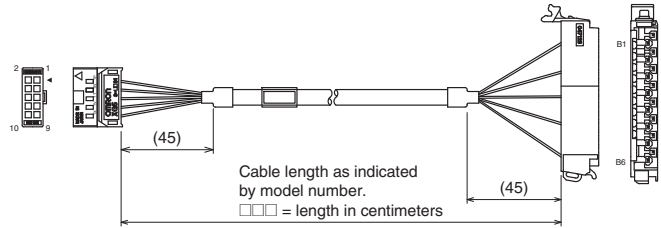
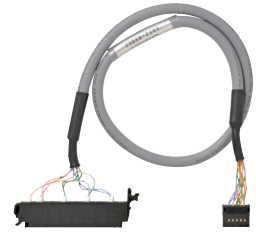

10 pole IDC mounting to P2RVC-8-□-F

P2RV-A□□□C-OMR NX

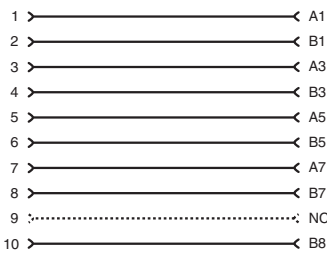

P2RV-A□□□IC-OMR NX

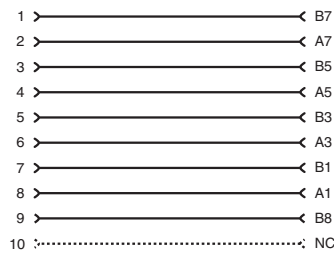

P2RV-□□□C-SIM S7/□00

Cables to connect Siemens S7/300 or S7/400 to 4 x P2RVC-8-□-F

List of Models

Model number	Cable length	PLC type	Configuration
P2RV-200C-SIM S7/300	2.0 m	Siemens S7/300 4x1 Byte	
P2RV-250C-SIM S7/300	2.5 m		
P2RV-300C-SIM S7/300	3.0 m		
P2RV-500C-SIM S7/300	5.0 m		
P2RV-200C-SIM S7/400	2.0 m	Siemens S7/400 4x1 Byte	
P2RV-250C-SIM S7/400	2.5 m		
P2RV-300C-SIM S7/400	3.0 m		
P2RV-500C-SIM S7/400	5.0 m		

■ Single Relays for Maintenance

Model Number Legend

G2RV-□ - □ □ □ - □ - □
 1 2 3 4 5 6

1. Number of Poles

1: 1 pole

2. Terminals

S: Plug-In

3. Relay LED

Blank: Without LED

4. Relay Test switch

Blank: No test switch

I: Test switch

5. Contact Material

Blank: AgSnIn

AP: AgSnIn hard gold-plated

6. Rated Coil Voltage

11 VDC, 21 VDC, 48 VDC

List of Models

Model number	Replacement for
G2RV-1-S 11 VDC	G2RV-SL700/500 12 VDC
G2RV-1-S 21 VDC	G2RV-SL700/500 24 VDC G2RV-SL700/500 24 VAC/DC
G2RV-1-S 48 VDC	G2RV-SL700/500 48 VAC/DC G2RV-SL700/500 110 VAC G2RV-SL700/500 230 VAC
G2RV-1-S-AP 11 VDC	G2RV-SL700/500-AP 12 VDC
G2RV-1-S-AP 21 VDC	G2RV-SL700/500-AP 24 VDC G2RV-SL700/500-AP 24 VAC/DC
G2RV-1-S-AP 48 VDC	G2RV-SL700/500-AP 48 VAC/DC G2RV-SL700/500-AP 110 VAC G2RV-SL700/500-AP 230 VAC
G2RV-1-SI 21 VDC	G2RV-SL701/501 24 VDC G2RV-SL701/501 24 VAC/DC

G2RV-1-SI



G2RV-1-S



■ Cross bars

Model Number Legend

P2RVM -□ □
 1 2

1. Number of Poles

020: 2 poles

030: 3 poles

040: 4 poles

100: 10 poles

200: 20 poles

2. Color

R: Red

S: Blue

B: Black

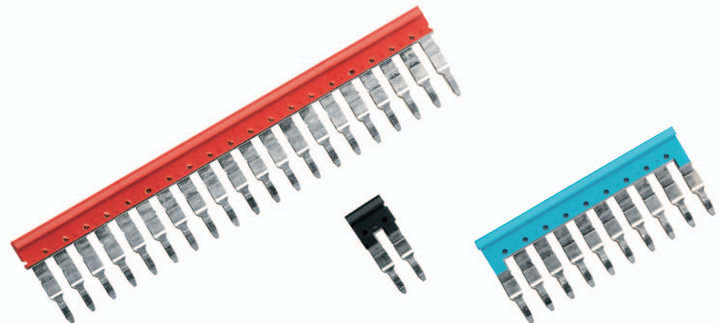

List of Models

Model number	Poles	Color
P2RVM-020□	2	Red (R) Blue (S) Black (B)
P2RVM-030□	3	
P2RVM-040□	4	
P2RVM-100□	10	
P2RVM-200□	20	

□ select color: R = Red, S=Blue, B=Black

Specification

Max current (EN60947-7-1 section 8.3.3 / 1991)	32 A
Max. Voltage	400 VAC
Max. Voltage when cutting Cross-bar without using separation plate or end-bracket	250 VAC

■ Plastic Labels for G2RV Sockets

Model number	Box quantity	Color
R99-15 for G2RV	1 piece = 1 sheet = 120 labels	White

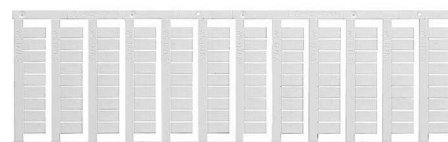

■ Labels (Stickers) for G2RV Sockets

Model number	Box quantity	Color
R99-16 for G2RV	1 piece = 1 sheet = 484 labels (stickers)	White

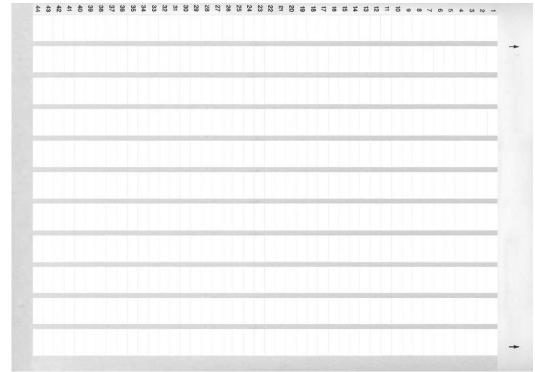

■ Separating Plates

Model number	Description
P2RV-S	Provides isolation between adjacent relays to achieve 400 V isolation.



Dimensions

Note: All units are in millimeters unless otherwise indicated.

Complete Unit

G2RV-SL700
G2RV-SL700-AP

Dimensions

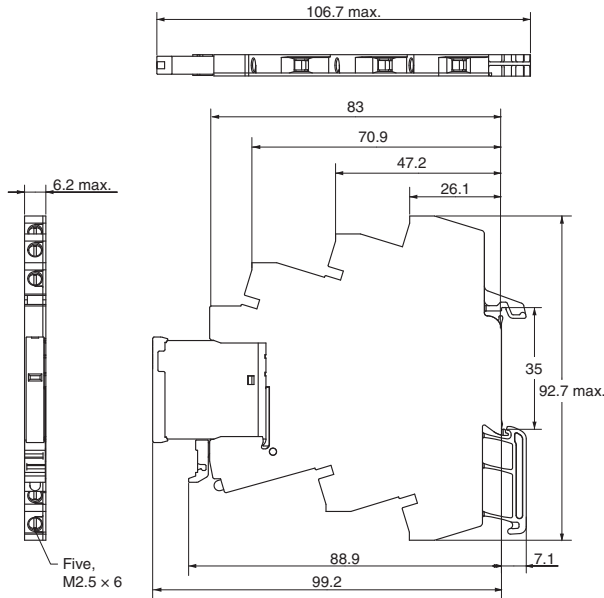

Terminal Arrangement

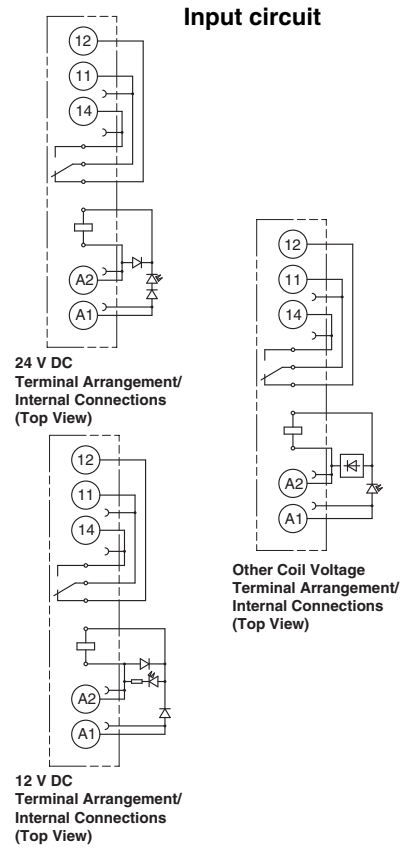

G2RV-SL701

Dimensions

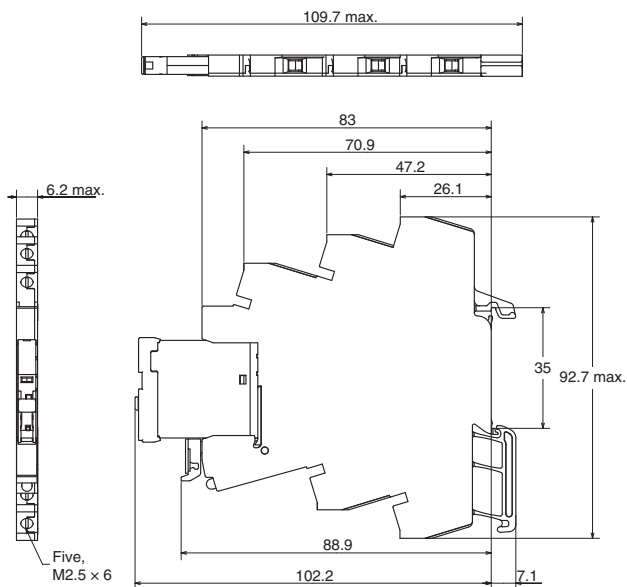

Terminal Arrangement

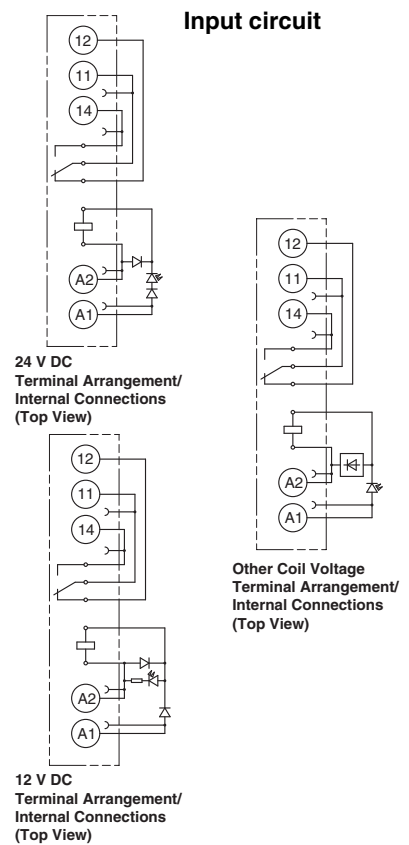

**G2RV-SL500
G2RV-SL500-AP**

Dimensions

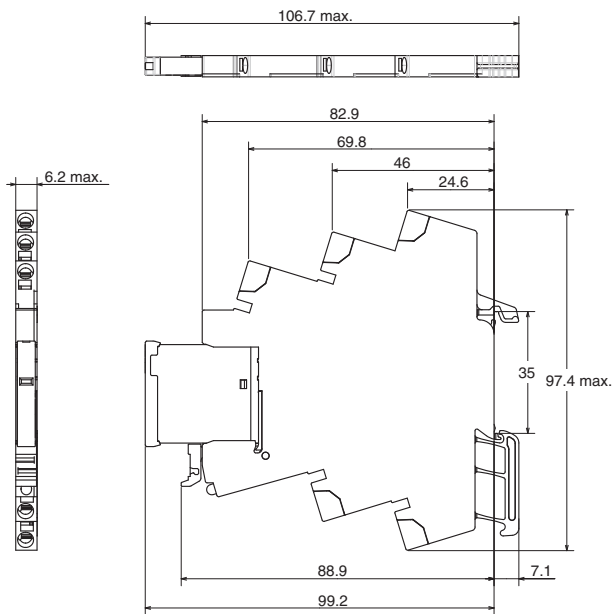

Terminal Arrangement

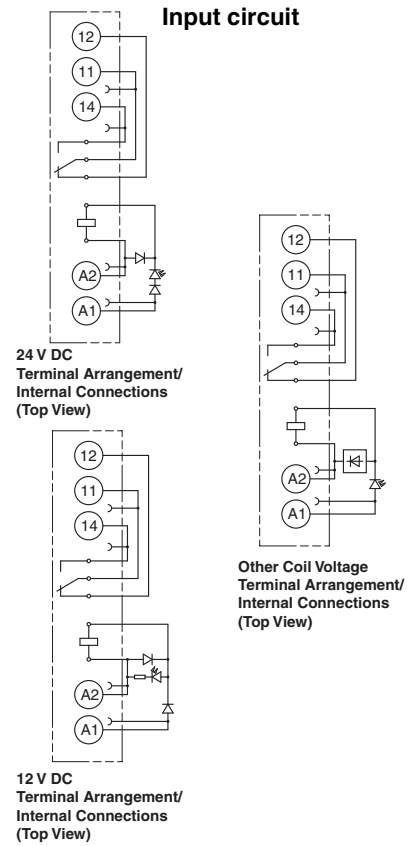

G2RV-SL501

Dimensions

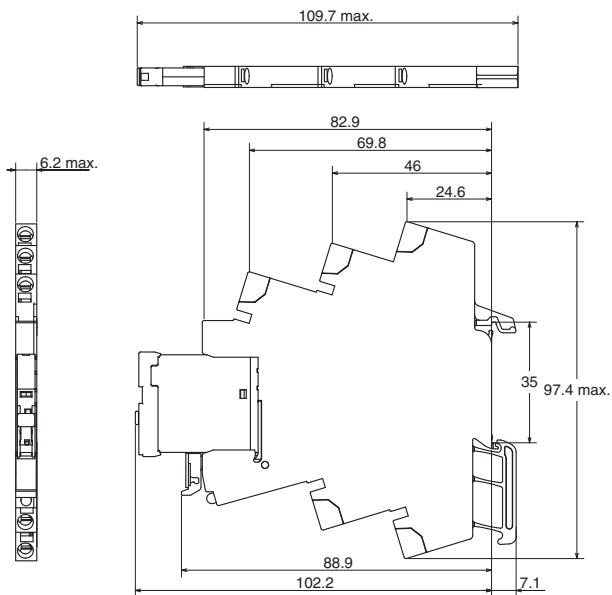

Terminal Arrangement

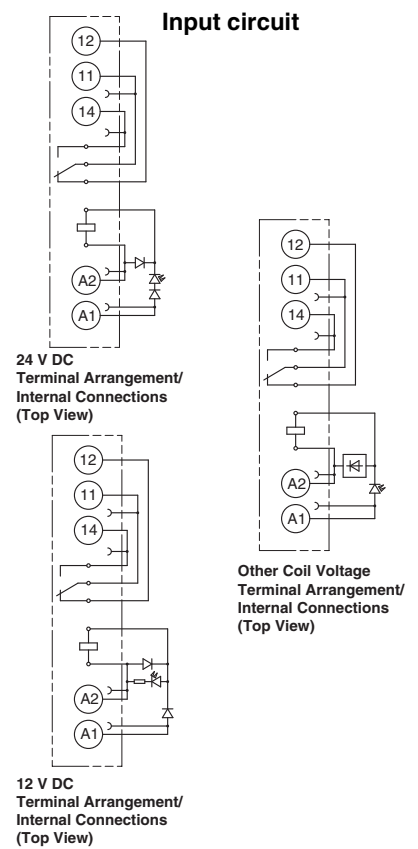

Single Relay

**G2RV-1-S
G2RV-1-S-AP**

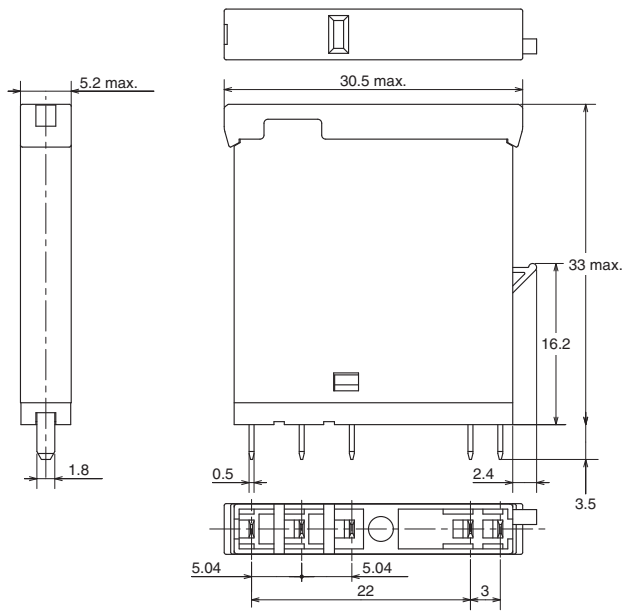

Input circuit

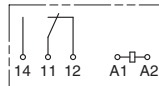

**Terminal Arrangement/
Internal Connections
(Bottom View)**

G2RV-1-SI

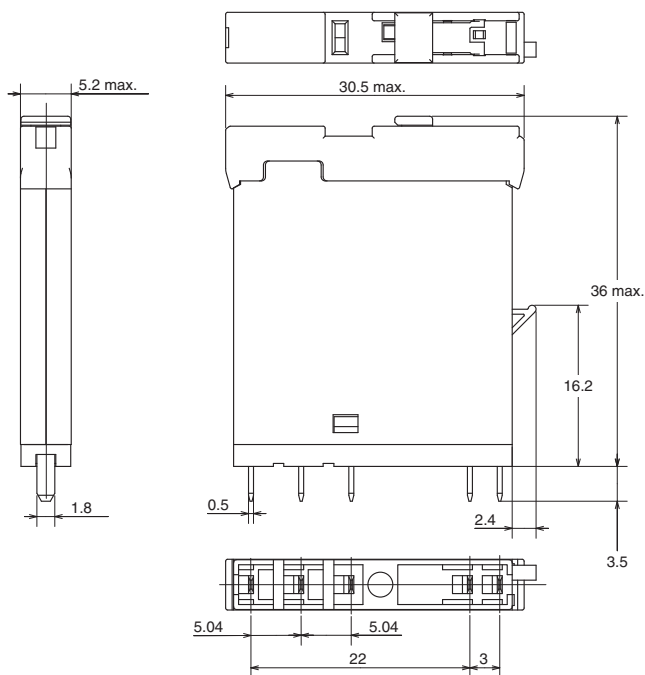

Input circuit

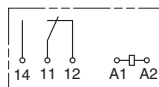

**Terminal Arrangement/
Internal Connections
(Bottom View)**

Installation

■ Tools

G2RV-SL70□ series: Flat-Blade screwdriver should be used for mounting and / or releasing cables.

G2RV-SL50□ series: Flat-Blade screwdriver should be used for mounting stranded wires without ferrules and / or releasing cables.

Applicable Screwdriver

- Flat-blade, Parallel-tip, 2.5 mm diameter (3.0 mm max.)

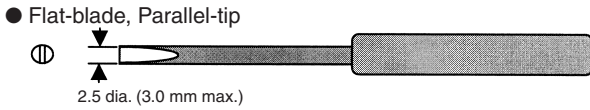

Cannot be used.

- Examples: FACOM AEF.2.5×75E (AEF. 3×75E)
 VESSEL No. 9900-(-)2.5×75 (No. 9900-(-)3×100)
 WAGO 210-119
 WIHA 260/2.5×40 (260/3×50)

*Chamfering the tip of the driver improves insertion when used as an exclusive tool.

P2RVC-8-O-F (for G2RV-SL70□ series only)

List of Models

Model number	Description	Connection
P2RVC-8-O-F	PLC Output Interface for 8x G2RV-SL70□-series PNP - type	Ribbon cable connector 10 Pole, IEC603/1

■ Applicable Wires

Applicable Wire Sizes

G2RV-SL700 Series

Box clamp technology

Wire type	Applicable wire size	Stripping length
Stranded without ferrules	0.5 - 2.5 mm ²	7 mm
Stranded with ferrules and plastic collar	0.5 - 2.5 mm ²	7 mm
Stranded with ferrules without plastic collar	0.5 - 2.5 mm ²	7 mm
Solid	0.5 - 2.5 mm ²	7 mm

G2RV-SL500 Series

Push-in technology

Wire type	Applicable wire size	Stripping length
Stranded without ferrules	0.5 - 2.5 mm ²	12 mm
Stranded with ferrules and plastic collar	0.5 - 2.5 mm ²	12 mm
Stranded with ferrules without plastic collar	0.5 - 2.5 mm ²	12 mm
Solid	0.5 - 2.5 mm ²	12 mm

■ Wiring

Use wires of the applicable sizes specified above. The length of the exposed conductor should be 7 mm for a G2RV-SL700 series, 12 mm for a G2RV-SL500 series.

G2RV-SL700

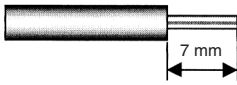

G2RV-SL500

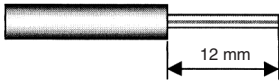
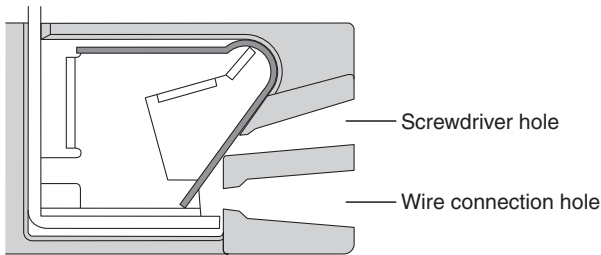
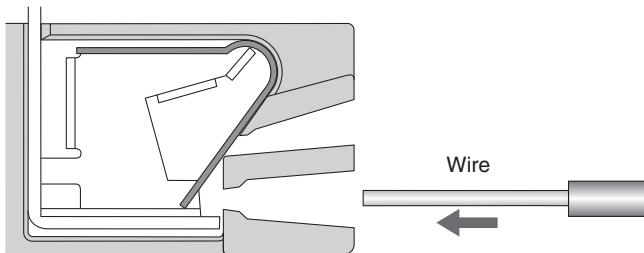

Fig. 1 Exposed Conductor Length

Wiring Procedure for G2RV-SL500 series



● Wiring



Insert the exposed conductor into the connection hole.

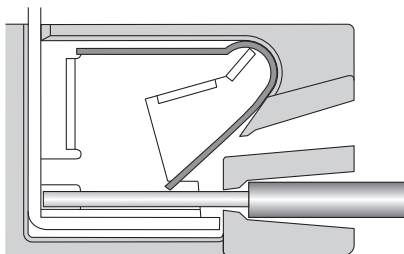

No other tools are required.

Note: In case of wiring stranded wires without ferrules screwdriver should be inserted before inserting the wire.
Screwdriver should be removed after fully insertion of the wire.

● Removing

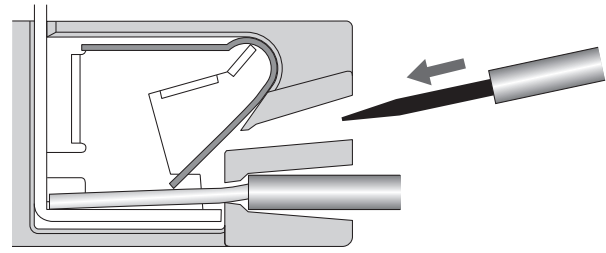

Insert the specified screwdriver into the release hole.

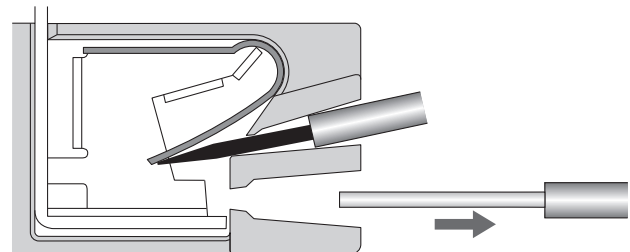

Removing wire.

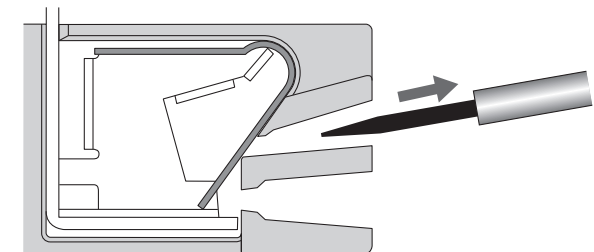

Removing screwdriver.

Precautions

Precautions for Connection

- Do not move the screwdriver up, down, or from side to side while it is inserted in the hole. Doing so may cause damage to internal components (e.g., deformation of the clamp spring or cracks in the housing) or cause deterioration of insulation.
- Do not insert the screwdriver at an angle. Doing so may break the side of socket and result in a short-circuit.

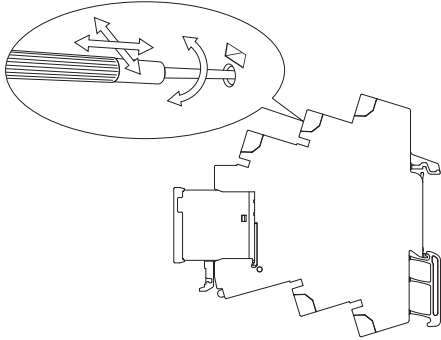

- Do not insert two or more wires in the hole. Wires may come in contact with the spring causing a temperature rise or be subject to sparks.

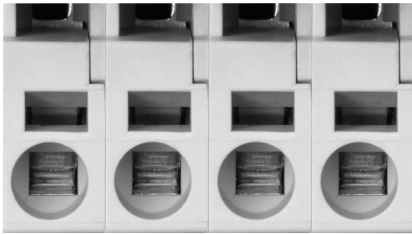

- Insert the screwdriver along the hole wall as shown below.

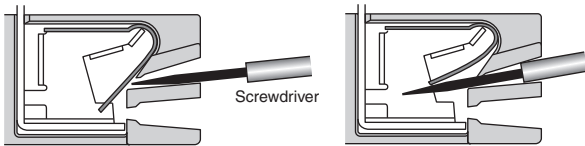

- If lubricating liquid, such as oil, is present on the tip of screwdriver, the screwdriver may fall out resulting in injury to the operator.
- Insert the screwdriver into the bottom of the hole. It may not be possible to connect cables properly if the screwdriver is inserted incorrectly.

General Precautions

- Do not use the product if it has been dropped on the ground. Dropping the product may adversely affect performance.
- Confirm that the socket is securely attached to the mounting track before wiring. If the socket is mounted insecurely it may fall and injure the operator.
- Ensure that the socket is not charged during wiring and maintenance. Not doing so may result in electric shock.

- Do not pour water or cleansing agents on the product. Doing so may result in electric shock.
- Do not use the socket in locations subject to solvents or alkaline chemicals.
- Do not use the socket in locations subject to ultraviolet light (e.g., direct sunlight). Doing so may result in markings fading, rust, corrosion, or resin deterioration.
- Do not dispose the product in fire.

Removing from Mounting Rail

To remove the socket from the mounting rail, insert the tip of screwdriver in the fixture rail, and move it in the direction shown below.

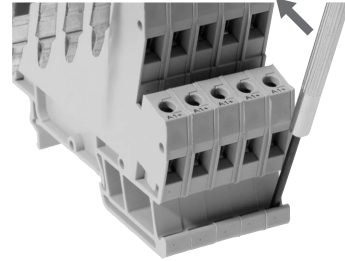

Precaution for Operation of Test switch

■ **Tool: G2RV-SL701/501 series: 2.5 mm width Flat-Blade screwdriver should be used for operation of test switch.**

- Flat-blade, Parallel-tip, 2.5 mm diameter (3.0 mm max.)

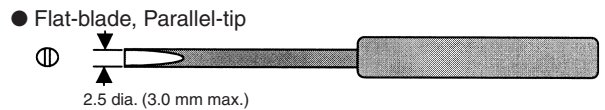

Cannot be used.

■ Cautions:

- When you operate a test switch, please turn off electrical power supply.
- After you have finished to operate a test switch, return the test switch to its original state
- Do not use test switch as a switch.
- Durability of test switch operation is more than 100 times.
- Please avoid to use the latching lever by ON state with carry current in long time, more than 24 hours to maintain the initial performance for operation checking.

ALL DIMENSIONS SHOWN ARE IN MILLIMETERS.

To convert millimeters into inches, multiply by 0.03937. To convert grams into ounces, multiply by 0.03527.

In the interest of product improvement, specifications are subject to change without notice.

Terms and Conditions of Sale

1. **Offer; Acceptance.** These terms and conditions (these "**Terms**") are deemed part of all quotes, agreements, purchase orders, acknowledgments, price lists, catalogs, manuals, brochures and other documents, whether electronic or in writing, relating to the sale of products or services (collectively, the "**Products**") by Omron Electronics LLC and its subsidiary companies ("**Omron**"). Omron objects to any terms or conditions proposed in Buyer's purchase order or other documents which are inconsistent with, or in addition to, these Terms.
2. **Prices; Payment Terms.** All prices stated are current, subject to change without notice by Omron. Omron reserves the right to increase or decrease prices on any unshipped portions of outstanding orders. Payments for Products are due net 30 days unless otherwise stated in the invoice.
3. **Discounts.** Cash discounts, if any, will apply only on the net amount of invoices sent to Buyer after deducting transportation charges, taxes and duties, and will be allowed only if (i) the invoice is paid according to Omron's payment terms and (ii) Buyer has no past due amounts.
4. **Interest.** Omron, at its option, may charge Buyer 1-1/2% interest per month or the maximum legal rate, whichever is less, on any balance not paid within the stated terms.
5. **Orders.** Omron will accept no order less than \$200 net billing.
6. **Governmental Approvals.** Buyer shall be responsible for, and shall bear all costs involved in, obtaining any government approvals required for the importation or sale of the Products.
7. **Taxes.** All taxes, duties and other governmental charges (other than general real property and income taxes), including any interest or penalties thereon, imposed directly or indirectly on Omron or required to be collected directly or indirectly by Omron for the manufacture, production, sale, delivery, importation, consumption or use of the Products sold hereunder (including customs duties and sales, excise, use, turnover and license taxes) shall be charged to and remitted by Buyer to Omron.
8. **Financial.** If the financial position of Buyer at any time becomes unsatisfactory to Omron, Omron reserves the right to stop shipments or require satisfactory security or payment in advance. If Buyer fails to make payment or otherwise comply with these Terms or any related agreement, Omron may (without liability and in addition to other remedies) cancel any unshipped portion of Products sold hereunder and stop any Products in transit until Buyer pays all amounts, including amounts payable hereunder, whether or not then due, which are owing to it by Buyer. Buyer shall in any event remain liable for all unpaid accounts.
9. **Cancellation; Etc.** Orders are not subject to rescheduling or cancellation unless Buyer indemnifies Omron against all related costs or expenses.
10. **Force Majeure.** Omron shall not be liable for any delay or failure in delivery resulting from causes beyond its control, including earthquakes, fires, floods, strikes or other labor disputes, shortage of labor or materials, accidents to machinery, acts of sabotage, riots, delay in or lack of transportation or the requirements of any government authority.
11. **Shipping; Delivery.** Unless otherwise expressly agreed in writing by Omron:
 - a. Shipments shall be by a carrier selected by Omron; Omron will not drop ship except in "break down" situations.
 - b. Such carrier shall act as the agent of Buyer and delivery to such carrier shall constitute delivery to Buyer;
 - c. All sales and shipments of Products shall be FOB shipping point (unless otherwise stated in writing by Omron), at which point title and risk of loss shall pass from Omron to Buyer; provided that Omron shall retain a security interest in the Products until the full purchase price is paid;
 - d. Delivery and shipping dates are estimates only; and
 - e. Omron will package Products as it deems proper for protection against normal handling and extra charges apply to special conditions.
12. **Claims.** Any claim by Buyer against Omron for shortage or damage to the Products occurring before delivery to the carrier must be presented in writing to Omron within 30 days of receipt of shipment and include the original transportation bill signed by the carrier noting that the carrier received the Products from Omron in the condition claimed.
13. **Warranties.** (a) **Exclusive Warranty.** Omron's exclusive warranty is that the Products will be free from defects in materials and workmanship for a period of twelve months from the date of sale by Omron (or such other period expressed in writing by Omron). Omron disclaims all other warranties, express or implied. (b) **Limitations.** OMRON MAKES NO WARRANTY OR REPRESENTATION, EXPRESS OR IMPLIED, ABOUT NON-INFRINGEMENT, MERCHANTABILITY OR FITNESS FOR A PARTICULAR PURPOSE OF THE PRODUCTS. BUYER ACKNOWLEDGES THAT IT ALONE HAS DETERMINED THAT THE PRODUCTS WILL SUITABLY MEET THE REQUIREMENTS OF THEIR INTENDED USE. Omron further disclaims all warranties and responsibility of any type for claims or expenses based on infringement by the Products or otherwise of any intellectual property right. (c) **Buyer Remedy.** Omron's sole obligation hereunder shall be, at Omron's election, to (i) replace (in the form originally shipped with Buyer responsible for labor charges for removal or replacement thereof) the non-complying Product, (ii) repair the non-complying Product, or (iii) repay or credit Buyer an amount equal to the purchase price of the non-complying Product; provided that in no event shall Omron be responsible for warranty, repair, indemnity or any other claims or expenses regarding the Products unless Omron's analysis confirms that the Products were properly handled, stored, installed and maintained and not subject to contamination, abuse, misuse or inappropriate modification. Return of any Products by Buyer must be approved in writing by Omron before shipment. Omron Companies shall not be liable for the suitability or unsuitability or the results from the use of Products in combination with any electrical or electronic components, circuits, system assemblies or any other materials or substances or environments. Any advice, recommendations or information given orally or in writing, are not to be construed as an amendment or addition to the above warranty. See <http://www.omron247.com> or contact your Omron representative for published information.
14. **Limitation on Liability; Etc.** OMRON COMPANIES SHALL NOT BE LIABLE FOR SPECIAL, INDIRECT, INCIDENTAL, OR CONSEQUENTIAL DAMAGES, LOSS OF PROFITS OR PRODUCTION OR COMMERCIAL LOSS IN ANY WAY CONNECTED WITH THE PRODUCTS, WHETHER SUCH CLAIM IS BASED IN CONTRACT, WARRANTY, NEGLIGENCE OR STRICT LIABILITY. Further, in no event shall liability of Omron Companies exceed the individual price of the Product on which liability is asserted.
15. **Indemnities.** Buyer shall indemnify and hold harmless Omron Companies and their employees from and against all liabilities, losses, claims, costs and expenses (including attorney's fees and expenses) related to any claim, investigation, litigation or proceeding (whether or not Omron is a party) which arises or is alleged to arise from Buyer's acts or omissions under these Terms or in any way with respect to the Products. Without limiting the foregoing, Buyer (at its own expense) shall indemnify and hold harmless Omron and defend or settle any action brought against such Companies to the extent based on a claim that any Product made to Buyer specifications infringed intellectual property rights of another party.
16. **Property; Confidentiality.** Any intellectual property in the Products is the exclusive property of Omron Companies and Buyer shall not attempt to duplicate it in any way without the written permission of Omron. Notwithstanding any charges to Buyer for engineering or tooling, all engineering and tooling shall remain the exclusive property of Omron. All information and materials supplied by Omron to Buyer relating to the Products are confidential and proprietary, and Buyer shall limit distribution thereof to its trusted employees and strictly prevent disclosure to any third party.
17. **Export Controls.** Buyer shall comply with all applicable laws, regulations and licenses regarding (i) export of products or information; (ii) sale of products to "forbidden" or other proscribed persons; and (iii) disclosure to non-citizens of regulated technology or information.
18. **Miscellaneous.** (a) **Waiver.** No failure or delay by Omron in exercising any right and no course of dealing between Buyer and Omron shall operate as a waiver of rights by Omron. (b) **Assignment.** Buyer may not assign its rights hereunder without Omron's written consent. (c) **Law.** These Terms are governed by the law of the jurisdiction of the home office of the Omron company from which Buyer is purchasing the Products (without regard to conflict of law principles). (d) **Amendment.** These Terms constitute the entire agreement between Buyer and Omron relating to the Products, and no provision may be changed or waived unless in writing signed by the parties. (e) **Severability.** If any provision hereof is rendered ineffective or invalid, such provision shall not invalidate any other provision. (f) **Setoff.** Buyer shall have no right to set off any amounts against the amount owing in respect of this invoice. (g) **Definitions.** As used herein, "including" means "including without limitation"; and "Omron Companies" (or similar words) mean Omron Corporation and any direct or indirect subsidiary or affiliate thereof.

Certain Precautions on Specifications and Use

1. **Suitability of Use.** Omron Companies shall not be responsible for conformity with any standards, codes or regulations which apply to the combination of the Product in the Buyer's application or use of the Product. At Buyer's request, Omron will provide applicable third party certification documents identifying ratings and limitations of use which apply to the Product. This information by itself is not sufficient for a complete determination of the suitability of the Product in combination with the end product, machine, system, or other application or use. Buyer shall be solely responsible for determining appropriateness of the particular Product with respect to Buyer's application, product or system. Buyer shall take application responsibility in all cases but the following is a non-exhaustive list of applications for which particular attention must be given:
 - (i) Outdoor use, uses involving potential chemical contamination or electrical interference, or conditions or uses not described in this document.
 - (ii) Use in consumer products or any use in significant quantities.
 - (iii) Energy control systems, combustion systems, railroad systems, aviation systems, medical equipment, amusement machines, vehicles, safety equipment, and installations subject to separate industry or government regulations.
 - (iv) Systems, machines and equipment that could present a risk to life or property. Please know and observe all prohibitions of use applicable to this Product.

NEVER USE THE PRODUCT FOR AN APPLICATION INVOLVING SERIOUS RISK TO LIFE OR PROPERTY OR IN LARGE QUANTITIES WITHOUT ENSURING THAT THE SYSTEM AS A WHOLE HAS BEEN DESIGNED TO ADDRESS THE RISKS, AND THAT THE OMRON'S PRODUCT IS PROPERLY RATED AND INSTALLED FOR THE INTENDED USE WITHIN THE OVERALL EQUIPMENT OR SYSTEM.
2. **Programmable Products.** Omron Companies shall not be responsible for the user's programming of a programmable Product, or any consequence thereof.
3. **Performance Data.** Data presented in Omron Company websites, catalogs and other materials is provided as a guide for the user in determining suitability and does not constitute a warranty. It may represent the result of Omron's test conditions, and the user must correlate it to actual application requirements. Actual performance is subject to the Omron's Warranty and Limitations of Liability.
4. **Change in Specifications.** Product specifications and accessories may be changed at any time based on improvements and other reasons. It is our practice to change part numbers when published ratings or features are changed, or when significant construction changes are made. However, some specifications of the Product may be changed without any notice. When in doubt, special part numbers may be assigned to fix or establish key specifications for your application. Please consult with your Omron's representative at any time to confirm actual specifications of purchased Product.
5. **Errors and Omissions.** Information presented by Omron Companies has been checked and is believed to be accurate; however, no responsibility is assumed for clerical, typographical or proofreading errors or omissions.