

**Q2L Series - 3x3 QFN**

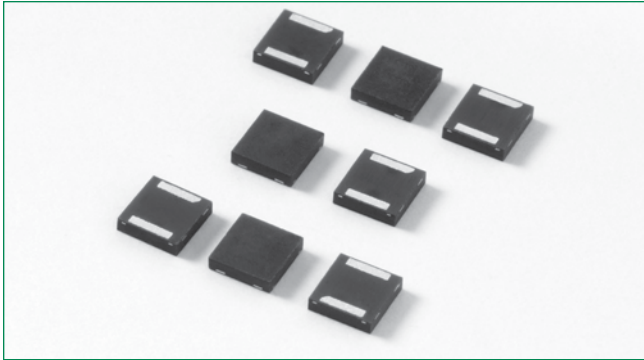

**Description**

Q2L Series 3x3 QFN are low capacitance SIDACtor® thyristors designed to protect high density broadband equipment from damaging overvoltage transients.

The series provides a low profile surface solution that enables broadband equipment to comply with global regulatory standards while limiting the impact to broadband signals and board space.

**Agency Approvals**

Agency	Agency File Number
	E133083

**Schematic Symbol**

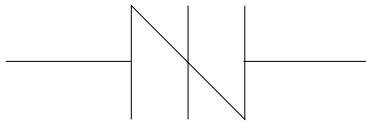

**Features and Benefits**

- Low voltage overshoot
- Low on-state voltage
- Low capacitance
- Does not degrade surge capability after multiple surge events within limit.
- Small footprint
- Fails short circuit when surged in excess of ratings
- RoHS Compliant and Halogen-Free
- Pb-free E3 means 2nd level interconnect is Pb-free and the terminal finish material is tin(Sn) (IPC/JEDEC J-STD-609A.01)
- Recognized to UL 497B as an Isolated Loop Circuit Protector

**Additional Information**



**Datasheet**



**Resources**



**Samples**

**Applicable Global Standards**

- TIA-968-A
- TIA-968-B
- ITU K.20/21/45 Enhanced Level\*
- ITU K.20/21/45 Basic Level
- IEC 61000-4-5 2nd edition
- GR 1089 Inter-building\*
- GR 1089 Intra-building
- YD/T 1082
- YD/T 993
- YD/T 950

\* A/B-Rated parts require series resistance

### Electrical Characteristics

Part Number	Marking	V <sub>DRM</sub> @ I <sub>DRM</sub> =5μA V min	V <sub>S</sub> @ 100V/μs V max	I <sub>H</sub> mA min	I <sub>S</sub> mA max	I <sub>T</sub> A max	V <sub>T</sub> @ I <sub>T</sub> = 2.2Amps V max	Capacitance @ 1MHz, 2V bias	
								pF Min	pF Max
P0080Q12ALRP	P-8A	6	25	50	800	2.2	5	25	55
P0300Q12ALRP	P03A	25	40	50	800	2.2	5	15	35
P0640Q12ALRP	P06A	58	77	150	800	2.2	5	40	60
P0720Q12ALRP	P07A	65	88	150	800	2.2	5	40	60
P0900Q12ALRP	P09A	75	98	150	800	2.2	5	35	55
P1100Q12ALRP	P11A	90	130	150	800	2.2	5	30	50
P1200Q12ALRP	P12A	100	130	150	800	2.2	5	30	50
P1300Q12ALRP	P13A	120	160	150	800	2.2	5	25	45
P1500Q12ALRP	P15A	140	180	150	800	2.2	5	25	40
P1800Q12ALRP	P18A	170	220	150	800	2.2	5	25	35
P2000Q12ALRP	P20A	180	220	150	800	2.2	5	25	35
P2300Q12ALRP	P23A	190	260	150	800	2.2	5	25	35
P2500Q12ALRP	P25A	230	290	150	800	2.2	5	25	35
P2600Q12ALRP	P26A	220	300	150	800	2.2	5	25	35
P3100Q12ALRP	P31A	275	350	150	800	2.2	5	20	35
P3500Q12ALRP	P35A	320	450	150	800	2.2	5	20	30
P0080Q12BLRP	P-8B	6	25	50	800	2.2	5	25	55
P0300Q12BLRP	P03B	25	40	50	800	2.2	5	15	35
P0640Q12BLRP	P06B	58	77	150	800	2.2	5	40	60
P0720Q12BLRP	P07B	65	88	150	800	2.2	5	40	60
P0900Q12BLRP	P09B	75	98	150	800	2.2	5	35	55
P1100Q12BLRP	P11B	90	130	150	800	2.2	5	30	50
P1200Q12BLRP	P12B	100	130	150	800	2.2	5	30	50
P1300Q12BLRP	P13B	120	160	150	800	2.2	5	25	45
P1500Q12BLRP	P15B	140	180	150	800	2.2	5	25	40
P1800Q12BLRP	P18B	170	220	150	800	2.2	5	25	35
P2000Q12BLRP	P20B	180	220	150	800	2.2	5	25	35
P2300Q12BLRP	P23B	190	260	150	800	2.2	5	25	35
P2500Q12BLRP	P25B	230	290	150	800	2.2	5	25	35
P2600Q12BLRP	P26B	220	300	150	800	2.2	5	25	35
P3100Q12BLRP	P31B	275	350	150	800	2.2	5	20	35
P3500Q12BLRP	P35B	320	400	150	800	2.2	5	20	30

**Notes:**

- Absolute maximum ratings measured at T<sub>A</sub>= 25°C (unless otherwise noted).
- Components are bi-directional.

### Surge Ratings

Series	I <sub>pp</sub>					I <sub>TSM</sub>	di/dt
	2/10μs	1.2/50μs/8/20μs	10/160μs	10/560μs	10/1000μs	50 / 60 Hz	
	A min	A min	A min	A min	A min	A min	A/μs max
A	150	150	90	50	45	20	500
B	250	250	150	100	80	25	500

**Notes:**

- Peak pulse current rating (I<sub>pp</sub>) is repetitive and guaranteed for the life of the product.
- I<sub>pp</sub> ratings applicable over temperature range of -40°C to +85°C
- The component must initially be in thermal equilibrium with -40°C ≤ T<sub>J</sub> ≤ +150°C

### Thermal Considerations

Package	Symbol	Parameter	Value	Unit
3x3 QFN 	T <sub>J</sub>	Operating Junction Temperature Range	-40 to +150	°C
	T <sub>S</sub>	Storage Temperature Range	-65 to +150	°C
	R <sub>θJA</sub>	Thermal Resistance: Junction to Ambient	120	°C/W

**V-I Characteristics**

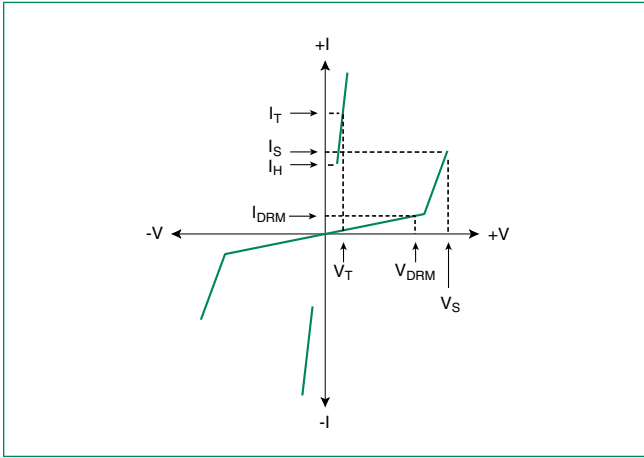

**$t_r \times t_d$  Pulse Waveform**

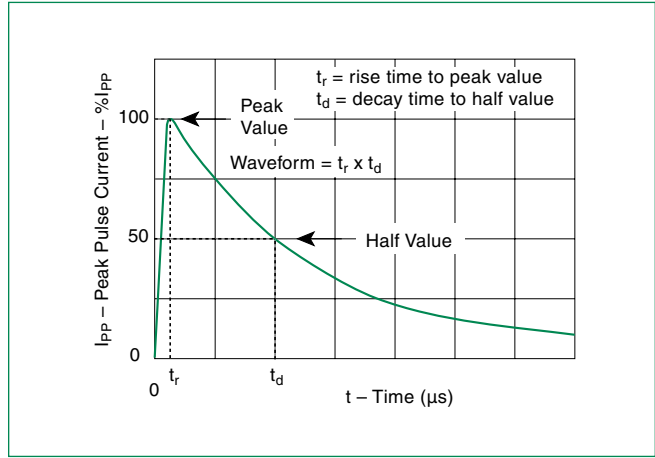

**Normalized  $V_S$  Change vs. Junction Temperature**

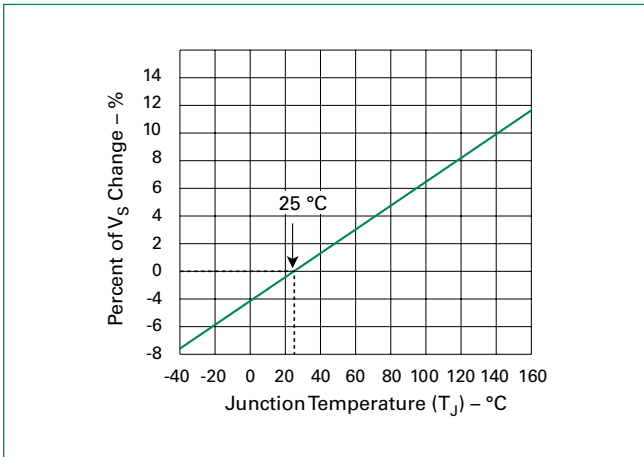

**Normalized DC Holding Current vs. Case Temperature**

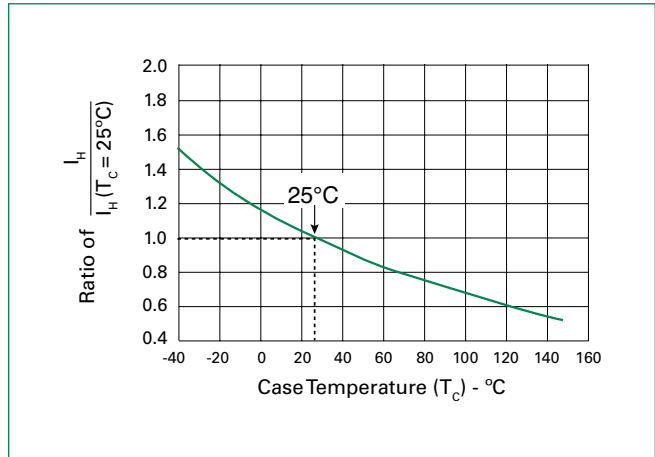

**Soldering Parameters**

<b>Reflow Condition</b>		Pb-Free assembly
<b>Pre Heat</b>	- Temperature Min ( $T_{s(\min)}$ )	+150°C
	- Temperature Max ( $T_{s(\max)}$ )	+200°C
	- Time (Min to Max) ( $t_s$ )	60-180 secs.
<b>Average ramp up rate (Liquidus Temp (<math>T_L</math>) to peak)</b>		3°C/sec. Max.
<b><math>T_{s(\max)}</math> to <math>T_L</math> - Ramp-up Rate</b>		3°C/sec. Max.
<b>Reflow</b>	- Temperature ( $T_L$ ) (Liquidus)	+217°C
	- Temperature ( $t_t$ )	60-150 secs.
<b>Peak Temp (<math>T_p</math>)</b>		+260(+0/-5)°C
<b>Time within 5°C of actual Peak Temp (<math>t_p</math>)</b>		30 secs. Max.
<b>Ramp-down Rate</b>		6°C/sec. Max.
<b>Time 25°C to Peak Temp (<math>T_p</math>)</b>		8 min. Max.
<b>Do not exceed</b>		+260°C

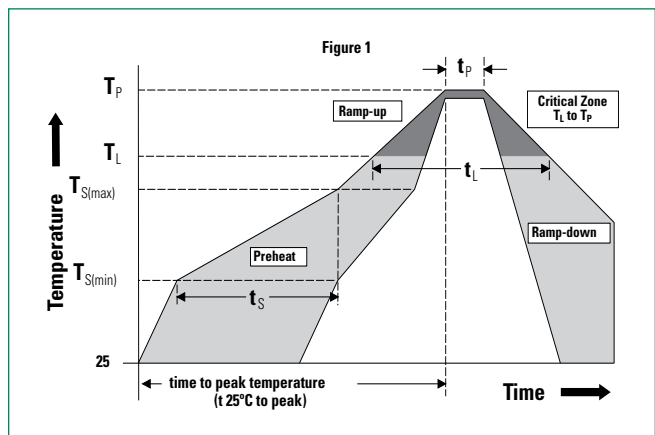

### Physical Specifications

<b>Lead Material</b>	Copper Alloy
<b>Terminal Finish</b>	100% Matte-Tin Plated
<b>Body Material</b>	UL Recognized epoxy meeting flammability classification V-0

### Environmental Specifications

<b>High Temp Voltage Blocking</b>	80% Rated $V_{DRM}$ ( $V_{AC, Peak}$ ) +125°C or +150°C, 504 or 1008 hrs. MIL-STD-750 (Method 1040) JEDEC, JESD22-A-101
<b>Temp Cycling</b>	-65°C to +150°C, 15 min. dwell, 10 up to 100 cycles. MIL-STD-750 (Method 1051) EIA/JEDEC, JESD22-A104
<b>Biased Temp &amp; Humidity</b>	52 $V_{DC}$ (+85°C) 85%RH, 504 up to 1008 hrs. EIA/JEDEC, JESD22-A-101
<b>High Temp Storage</b>	+150°C 1008 hrs. MIL-STD-750 (Method 1031) JEDEC, JESD22-A-101
<b>Low Temp Storage</b>	-65°C, 1008 hrs.
<b>Thermal Shock</b>	0°C to +100°C, 5 min. dwell, 10 sec. transfer, 10 cycles. MIL-STD-750 (Method 1056) JEDEC, JESD22-A-106
<b>Resistance to Solder Heat</b>	+260°C, 30 secs. MIL-STD-750 (Method 2031)
<b>Moisture Sensitivity Level</b>	85%RH, +85°C, 168 hrs., 3 reflow cycles (+260°C Peak). JEDEC-J-STD-020, Level 1

### Dimensions — 3x3 QFN

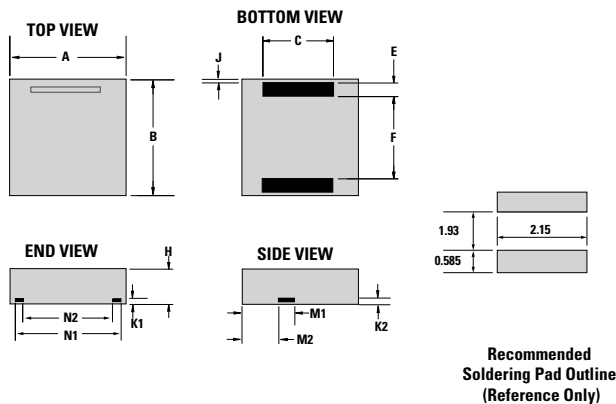

Dimensions	Inches		Millimeters	
	Min	Max	Min	Max
<b>A</b>	0.114	0.122	2.900	3.100
<b>B</b>	0.114	0.122	2.900	3.100
<b>C</b>	0.075	0.083	1.900	2.100
<b>E</b>	0.011	0.019	0.285	0.485
<b>F</b>	0.076	0.084	1.930	2.130
<b>H</b>	0.035	0.043	0.900	1.100
<b>J</b>	0.000	0.008	0.000	0.200
<b>K1</b>	0.004	0.012	0.100	0.300
<b>K2</b>	0.004	0.012	0.100	0.300
<b>M1</b>	0.056	0.064	1.430	1.630
<b>M2</b>	0.038	0.046	0.970	1.170
<b>N1</b>	0.096	0.104	2.440	2.640
<b>N2</b>	0.082	0.090	2.080	2.280

### Part Numbering

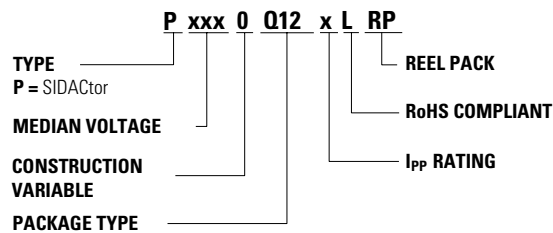

### Part Marking

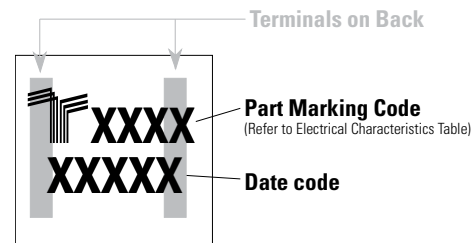

### Packing Options

Package Type	Description	Quantity	Added Suffix	Industry Standard
Q12	3x3 QFN Tape and Reel Pack	5000	RP	EIA-481-D