

**GPP TRANSIENT VOLTAGE SUPPRESSOR
400 WATT PEAK POWER 1.0 WATT STEADY STATE**

FEATURES

- * Plastic package has underwriters laboratory
- * Glass passivated chip construction
- * 400 watt surge capability at 1ms
- * Excellent clamping capability
- * Low zener impedance
- * Fast response time



DO-41

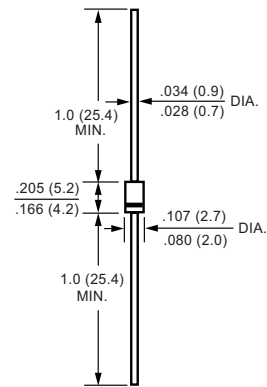

MAXIMUM RATINGS AND ELECTRICAL CHARACTERISTICS

Ratings at 25 °C ambient temperature unless otherwise specified.
Single phase, half wave, 60 Hz, resistive or inductive load,
For capacitive load, derate current by 20%.

DEVICES FOR BIPOLAR APPLICATIONS

For Bidirectional use C or CA suffix for types P4KE6.8 thru P4KE440

Electrical characteristics apply in both direction

MAXIMUM RATINGS (At TA = 25°C unless otherwise noted)

| RATINGS | SYMBOL | VALUE | UNITS |
|--|------------------|--------------|---------------------|
| Peak Power Dissipation at TA = 25°C, TP = 1mS (Note 1) | PPPM | Minimum 400 | Watts |
| Steady State Power Dissipation at TL = 75°C lead lengths, .375" (9.5 mm) (Note 2) | PM(AV) | 1.0 | Watts |
| Peak Forward Surge Current, 8.3ms single half sine wave-superimposed on rated load(JEDEC METHOD) (NoteS 2) | IFSM | 40 | Amps |
| Maximum Instantaneous Forward Current at 25A for unidirectional only (Note 3) | VF | 3.5/6.5 | Volts |
| Operating and Storage Temperature Range | TJ, TSTG | -55 to + 150 | °C |
| Typical Current Squared Time | I ² t | 6.64 | A ² /Sec |

2016-09
REV:A

- NOTES : 1. Non-repetitive current pulse, per Fig.3 and derated above TA = 25°C per Fig.2.
2. Mounted on 1.6 X 1.6" (40 X 40mm) per Fig. 5
3. VF = 3.0V max. for devices of V(BR) ≤ 220V and VF = 6.5 Volts max. for devices of V(BR) > 220V.
4. "Fully ROHS compliant", "100% Sn plating (Pb-free)".

RATING AND CHARACTERISTIC CURVES(P4KE6.8 THRU P4KE440CA)

FIG. 1 - PEAK PULSE POWER RATING CURVE

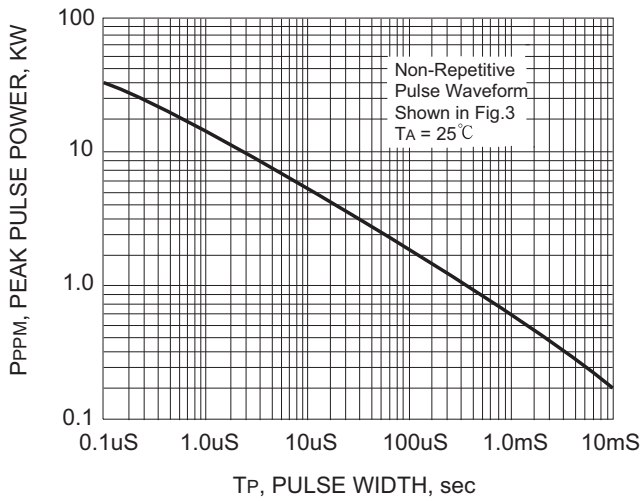

FIG. 2 - PULSE DERATING CURVE

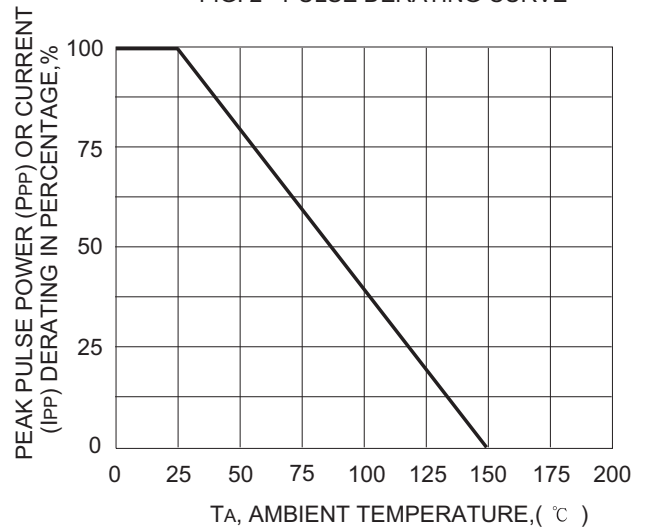

FIG. 3 - PULSE WAVEFORM

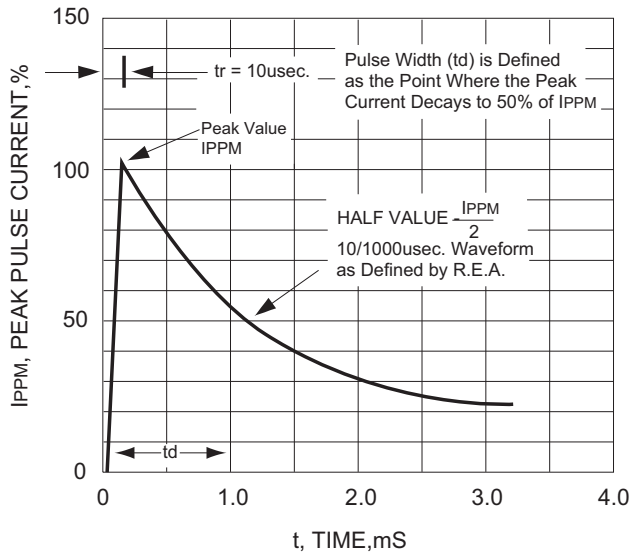
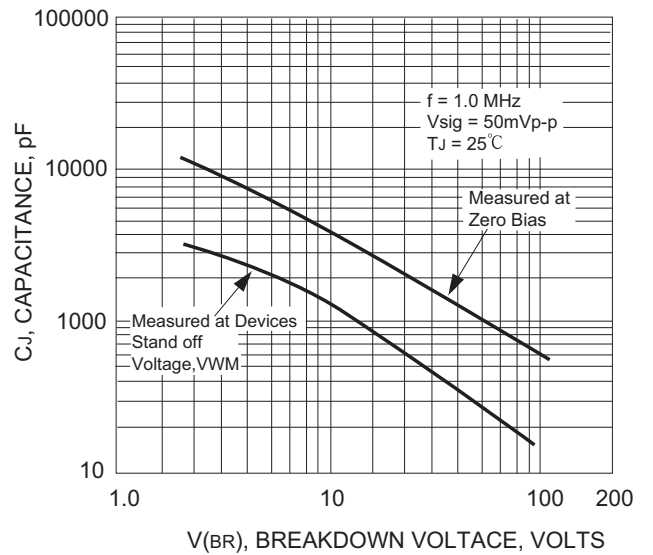

FIG. 4 - TYPICAL JUNCTION CAPACITANCE



RATING AND CHARACTERISTIC CURVES(P4KE6.8 THRU P4KE440CA)

FIG. 5 - STEADY STATE POWER DERATING CURVE

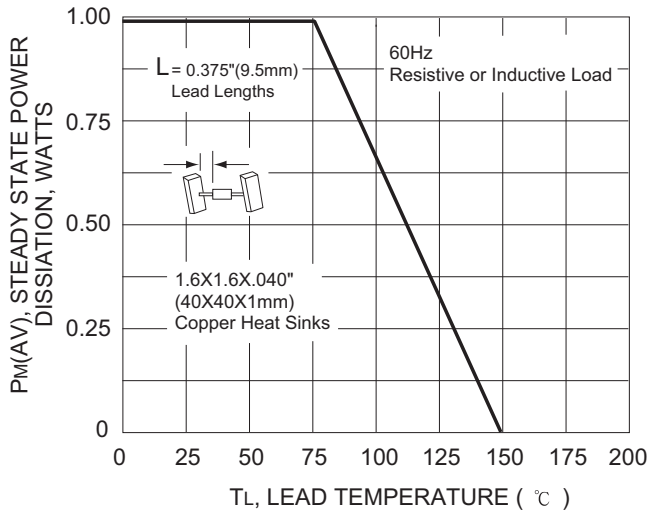

FIG. 6 - MAXIMUM NON-REPETITIVE FORWARD SURGE CURRENT UNIDIRECTIONAL

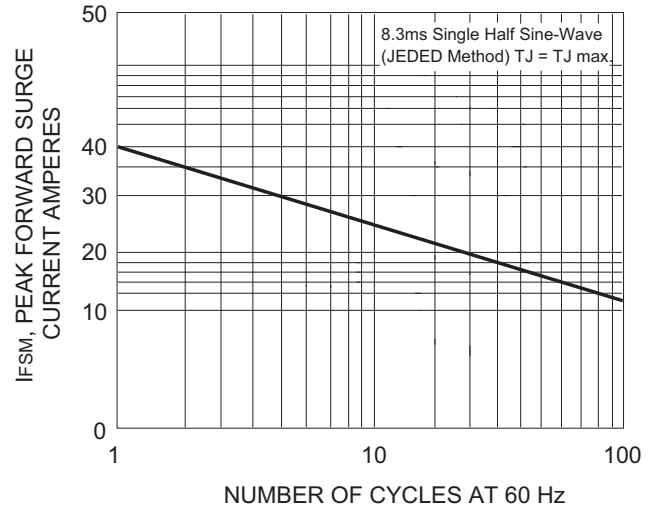
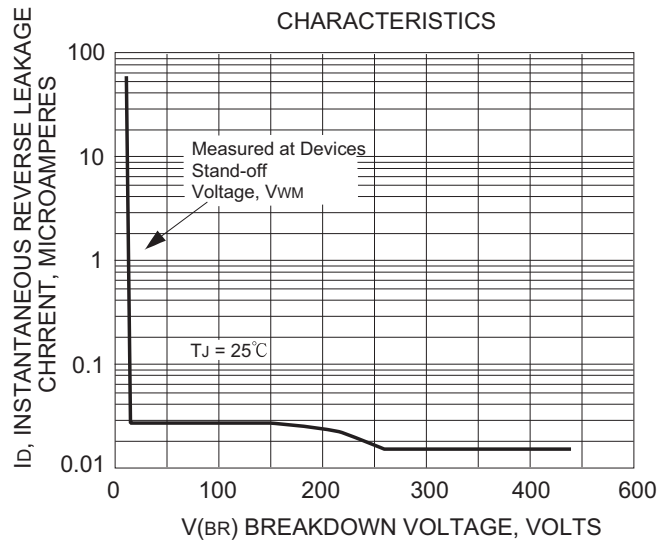

FIG. 7 - TYPICAL REVERSE LEAKAGE CHARACTERISTICS



TRANSIENT VOLTAGE SUPPRESSORS

400W SERIES TVS DIODES / DO-41 (CASE 7) 400W

| TYPE | Breakdown Voltage | | @I _T (mA) | Reverse Stand off Voltage V _{WM} (Volts) | Maximum Reverse Leakage at V _{WM} I _D (uA) | Maximum Peak Pulse Current I _{PPM} (Amps) | Maximum Clamping Voltage at I _{PPM} V _C (Volts) |
|----------|----------------------------|------|-------------------------|---|---|--|--|
| | V _{BR} (Volts) | | | | | | |
| | MIN. | MAX. | | | | | |
| P4KE6.8 | 6.12 | 7.48 | 10 | 5.50 | 1000 | 37 | 10.8 |
| P4KE6.8A | 6.45 | 7.14 | 10 | 5.80 | 1000 | 38.1 | 10.5 |
| P4KE7.5 | 6.75 | 8.25 | 10 | 6.05 | 500 | 34.2 | 11.7 |
| P4KE7.5A | 7.13 | 7.88 | 10 | 6.40 | 500 | 35.4 | 11.3 |
| P4KE8.2 | 7.38 | 9.02 | 10 | 6.63 | 200 | 32 | 12.5 |
| P4KE8.2A | 7.79 | 8.61 | 10 | 7.02 | 200 | 33.1 | 12.1 |
| P4KE9.1 | 8.19 | 10.0 | 1.0 | 7.37 | 50 | 29 | 13.8 |
| P4KE9.1A | 8.65 | 9.55 | 1.0 | 7.78 | 50 | 29.9 | 13.4 |
| P4KE10 | 9.00 | 11.0 | 1.0 | 8.10 | 10 | 26.7 | 15.0 |
| P4KE10A | 9.50 | 10.5 | 1.0 | 8.55 | 10 | 27.6 | 14.5 |
| P4KE11 | 9.90 | 12.1 | 1.0 | 8.92 | 5.0 | 24.7 | 16.2 |
| P4KE11A | 10.5 | 11.6 | 1.0 | 9.40 | 5.0 | 25.6 | 15.6 |
| P4KE12 | 10.8 | 13.2 | 1.0 | 9.72 | 5.0 | 23.1 | 17.3 |
| P4KE12A | 11.4 | 12.6 | 1.0 | 10.2 | 5.0 | 24 | 16.7 |
| P4KE13 | 11.7 | 14.3 | 1.0 | 10.5 | 5.0 | 21.1 | 19.0 |
| P4KE13A | 12.4 | 13.7 | 1.0 | 11.1 | 5.0 | 22 | 18.2 |
| P4KE15 | 13.5 | 16.5 | 1.0 | 12.1 | 5.0 | 18.2 | 22.0 |
| P4KE15A | 14.3 | 15.8 | 1.0 | 12.8 | 5.0 | 18.9 | 21.2 |
| P4KE16 | 14.4 | 17.6 | 1.0 | 12.9 | 5.0 | 17 | 23.5 |
| P4KE16A | 15.2 | 16.8 | 1.0 | 13.6 | 5.0 | 17.8 | 22.5 |
| P4KE18 | 16.2 | 19.8 | 1.0 | 14.5 | 5.0 | 15.1 | 26.5 |
| P4KE18A | 17.1 | 18.9 | 1.0 | 15.3 | 5.0 | 15.9 | 25.2 |
| P4KE20 | 18.0 | 22.0 | 1.0 | 16.2 | 5.0 | 13.7 | 29.1 |
| P4KE20A | 19.0 | 21.0 | 1.0 | 17.1 | 5.0 | 14.4 | 27.7 |
| P4KE22 | 19.8 | 24.2 | 1.0 | 17.8 | 5.0 | 12.5 | 31.9 |
| P4KE22A | 20.9 | 23.1 | 1.0 | 18.8 | 5.0 | 13.1 | 30.6 |
| P4KE24 | 21.6 | 26.4 | 1.0 | 19.4 | 5.0 | 11.5 | 34.7 |
| P4KE24A | 22.8 | 25.2 | 1.0 | 20.5 | 5.0 | 12 | 33.2 |
| P4KE27 | 24.3 | 29.7 | 1.0 | 21.8 | 5.0 | 10.2 | 39.1 |
| P4KE27A | 25.7 | 28.4 | 1.0 | 23.1 | 5.0 | 10.7 | 37.5 |
| P4KE30 | 27.0 | 33.0 | 1.0 | 24.3 | 5.0 | 9.2 | 43.5 |
| P4KE30A | 28.5 | 31.5 | 1.0 | 25.6 | 5.0 | 9.7 | 41.4 |
| P4KE33 | 29.7 | 36.3 | 1.0 | 26.8 | 5.0 | 8.4 | 47.7 |
| P4KE33A | 31.4 | 34.7 | 1.0 | 28.2 | 5.0 | 8.8 | 45.7 |
| P4KE36 | 32.4 | 39.6 | 1.0 | 29.1 | 5.0 | 7.7 | 52.0 |
| P4KE36A | 34.2 | 37.8 | 1.0 | 30.8 | 5.0 | 8.0 | 49.9 |
| P4KE39 | 35.1 | 42.9 | 1.0 | 31.6 | 5.0 | 7.1 | 56.4 |
| P4KE39A | 37.1 | 41.0 | 1.0 | 33.3 | 5.0 | 7.4 | 53.9 |
| P4KE43 | 38.7 | 47.3 | 1.0 | 34.8 | 5.0 | 6.5 | 61.9 |
| P4KE43A | 40.9 | 45.2 | 1.0 | 36.8 | 5.0 | 6.7 | 59.3 |
| P4KE47 | 42.3 | 51.7 | 1.0 | 38.1 | 5.0 | 5.9 | 67.8 |
| P4KE47A | 44.7 | 49.4 | 1.0 | 40.2 | 5.0 | 6.2 | 64.8 |
| P4KE51 | 45.9 | 56.1 | 1.0 | 41.3 | 5.0 | 5.4 | 73.5 |
| P4KE51A | 48.5 | 53.6 | 1.0 | 43.6 | 5.0 | 5.7 | 70.1 |
| P4KE56 | 50.4 | 61.6 | 1.0 | 45.4 | 5.0 | 5.0 | 80.5 |
| P4KE56A | 53.2 | 58.8 | 1.0 | 47.8 | 5.0 | 5.2 | 77.0 |

TRANSIENT VOLTAGE SUPPRESSORS

400W SERIES TVS DIODES / DO-41 (CASE 7) 400W

| TYPE | Breakdown Voltage | | @I _T (mA) | Reverse Stand off Voltage V _{WM} (Volts) | Maximum Reverse Leakage at V _{WM} I _D (uA) | Maximum Peak Pulse Current I _{PPM} (Amps) | Maximum Clamping Voltage at I _{PPM} V _C (Volts) |
|----------|----------------------------|------|-------------------------|---|---|--|--|
| | V _{BR} (Volts) | | | | | | |
| | MIN. | MAX. | | | | | |
| P4KE62 | 55.8 | 68.2 | 1.0 | 50.2 | 5.0 | 4.5 | 89.0 |
| P4KE62A | 58.9 | 65.1 | 1.0 | 53.0 | 5.0 | 4.7 | 85.0 |
| P4KE68 | 61.2 | 74.8 | 1.0 | 55.1 | 5.0 | 4.1 | 98.0 |
| P4KE68A | 64.6 | 71.4 | 1.0 | 58.1 | 5.0 | 4.3 | 92.0 |
| P4KE75 | 67.5 | 82.5 | 1.0 | 60.7 | 5.0 | 3.7 | 108 |
| P4KE75A | 71.3 | 78.8 | 1.0 | 64.1 | 5.0 | 3.9 | 103 |
| P4KE82 | 73.8 | 90.2 | 1.0 | 66.4 | 5.0 | 3.4 | 118 |
| P4KE82A | 77.9 | 86.1 | 1.0 | 70.1 | 5.0 | 3.5 | 113 |
| P4KE91 | 81.9 | 100 | 1.0 | 73.7 | 5.0 | 3.1 | 131 |
| P4KE91A | 86.5 | 95.5 | 1.0 | 77.8 | 5.0 | 3.2 | 125 |
| P4KE100 | 90.0 | 110 | 1.0 | 81.0 | 5.0 | 2.8 | 144 |
| P4KE100A | 95.0 | 105 | 1.0 | 85.5 | 5.0 | 2.9 | 137 |
| P4KE110 | 99.0 | 121 | 1.0 | 89.2 | 5.0 | 2.5 | 158 |
| P4KE110A | 105 | 116 | 1.0 | 94.0 | 5.0 | 2.6 | 152 |
| P4KE120 | 108 | 132 | 1.0 | 97.2 | 5.0 | 2.3 | 173 |
| P4KE120A | 114 | 126 | 1.0 | 102 | 5.0 | 2.4 | 165 |
| P4KE130 | 117 | 143 | 1.0 | 105 | 5.0 | 2.1 | 187 |
| P4KE130A | 124 | 137 | 1.0 | 111 | 5.0 | 2.2 | 179 |
| P4KE150 | 135 | 165 | 1.0 | 121 | 5.0 | 1.9 | 215 |
| P4KE150A | 143 | 158 | 1.0 | 128 | 5.0 | 1.9 | 207 |
| P4KE160 | 144 | 176 | 1.0 | 130 | 5.0 | 1.7 | 230 |
| P4KE160A | 152 | 168 | 1.0 | 136 | 5.0 | 1.8 | 219 |
| P4KE170 | 153 | 187 | 1.0 | 138 | 5.0 | 1.6 | 244 |
| P4KE170A | 162 | 179 | 1.0 | 145 | 5.0 | 1.7 | 234 |
| P4KE180 | 162 | 198 | 1.0 | 146 | 5.0 | 1.6 | 258 |
| P4KE180A | 171 | 189 | 1.0 | 154 | 5.0 | 1.6 | 246 |
| P4KE200 | 180 | 220 | 1.0 | 162 | 5.0 | 1.4 | 287 |
| P4KE200A | 190 | 210 | 1.0 | 171 | 5.0 | 1.5 | 274 |
| P4KE220 | 198 | 242 | 1.0 | 175 | 5.0 | 1.2 | 344 |
| P4KE220A | 209 | 231 | 1.0 | 185 | 5.0 | 1.2 | 328 |
| P4KE250 | 225 | 275 | 1.0 | 202 | 5.0 | 1.1 | 360 |
| P4KE250A | 237 | 263 | 1.0 | 214 | 5.0 | 1.2 | 344 |
| P4KE300 | 270 | 330 | 1.0 | 243 | 5.0 | 0.93 | 430 |
| P4KE300A | 285 | 315 | 1.0 | 256 | 5.0 | 1.00 | 414 |
| P4KE350 | 315 | 385 | 1.0 | 284 | 5.0 | 0.79 | 504 |
| P4KE350A | 333 | 368 | 1.0 | 300 | 5.0 | 0.83 | 482 |
| P4KE400 | 360 | 440 | 1.0 | 324 | 5.0 | 0.70 | 574 |
| P4KE400A | 380 | 420 | 1.0 | 342 | 5.0 | 0.73 | 548 |
| P4KE440 | 396 | 484 | 1.0 | 356 | 5.0 | 0.63 | 631 |
| P4KE440A | 418 | 462 | 1.0 | 376 | 5.0 | 0.66 | 602 |

- Notes :
1. V_{BR} measured after I_T applied for 300ms. I_T = square pulse or equivalent.
 2. For bidirectional use C or CA suffixs for all types (ex. P4KE6.8C,P4KE440CA) electrical characteristics apply in both directions.
 3. For bidirectional types having V_{WM} of 10 volts and less, the I_D limit is doubled.

Marking Description

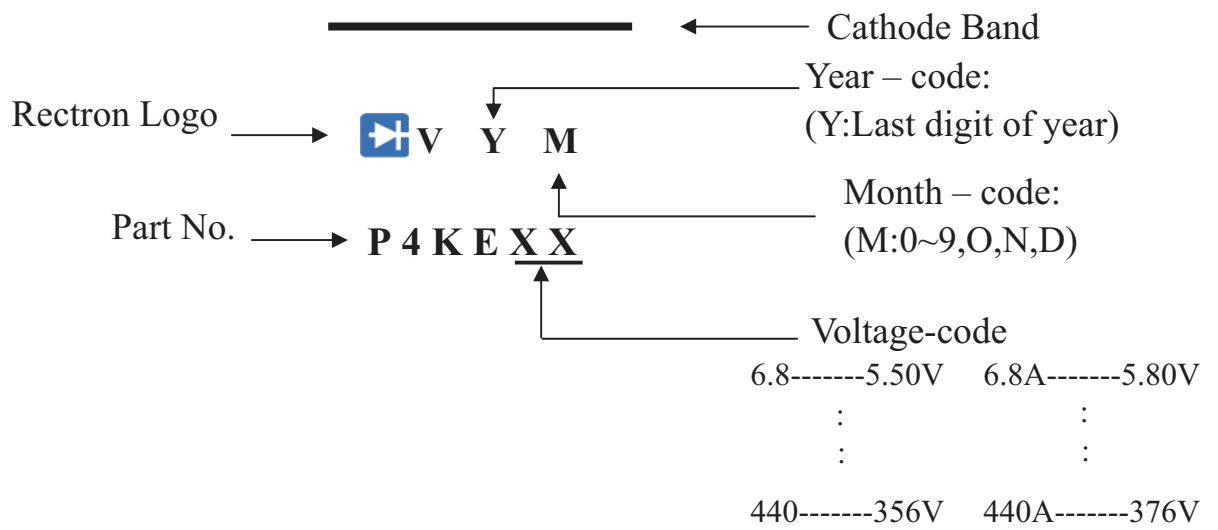

PACKAGING OF DIODE AND BRIDGE RECTIFIERS

BULK PACK

| PACKAGE | PACKING CODE | EA PER BOX | INNER BOX SIZE (mm) | CARTON SIZE (mm) | EA PER CARTON | GROSS WEIGHT(Kg) |
|---------|--------------|------------|---------------------|------------------|---------------|------------------|
| DO-41 | -B | 1,000 | 194*75*21 | 415*220*255 | 50,000 | 16.2 |

REEL PACK

| PACKAGE | PACKING CODE | EA PER REEL | EA PER INNER BOX | COMPONENT SPACE (mm) | TAPE SPACE (mm) | REEL DIA (mm) | CARTON SIZE (mm) | EA PER CARTON | GROSS WEIGHT(Kg) |
|---------|--------------|-------------|------------------|----------------------|-----------------|---------------|------------------|---------------|------------------|
| DO-41 | -T | 5,000 | 5,000 | 5.0 | 52 | 330 | 355*350*335 | 20,000 | 10.49 |

AMMO PACK

| PACKAGE | PACKING CODE | REEL (EA) | COMPONENT SPACE(mm) | TAPE SPACE (mm) | BOX SIZE (mm) | CARTON SIZE(mm) | CARTON (EA) | GROSS WEIGHT (Kg) |
|---------|--------------|-------------|---------------------|-----------------|---------------|-----------------|---------------|-------------------|
| DO-41 | -F | 3,000 | 5.0 | 52 | 255*73*100 | 400*268*225 | 30,000 | 13.0 |
| DO-41 | -E | 3,000 | 5.0 | 26 | 256*48*94 | 365*270*217 | 42,000 | 12.41 |