

**GPP TRANSIENT VOLTAGE SUPPRESSOR  
400 WATT PEAK POWER 1.0 WATT STEADY STATE**

**FEATURES**

- \* Plastic package has underwriters laboratory
- \* Glass passivated chip construction
- \* 400 watt surge capability at 1ms
- \* Excellent clamping capability
- \* Low zener impedance
- \* Fast response time



**DO-41**

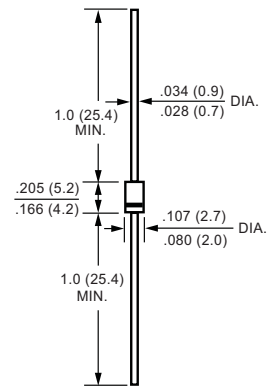

**MAXIMUM RATINGS AND ELECTRICAL CHARACTERISTICS**

Ratings at 25 °C ambient temperature unless otherwise specified.  
Single phase, half wave, 60 Hz, resistive or inductive load,  
For capacitive load, derate current by 20%.

**DEVICES FOR BIPOLAR APPLICATIONS**

For Bidirectional use C or CA suffix for types P4KE6.8 thru P4KE440

Electrical characteristics apply in both direction

MAXIMUM RATINGS (At TA = 25°C unless otherwise noted)

RATINGS	SYMBOL	VALUE	UNITS
Peak Power Dissipation at TA = 25°C, TP = 1mS ( Note 1 )	PPPM	Minimum 400	Watts
Steady State Power Dissipation at TL = 75°C lead lengths, .375" ( 9.5 mm ) ( Note 2 )	PM(AV)	1.0	Watts
Peak Forward Surge Current, 8.3ms single half sine wave-superimposed on rated load( JEDEC METHOD ) ( NoteS 2 )	IFSM	40	Amps
Maximum Instantaneous Forward Current at 25A for unidirectional only ( Note 3 )	VF	3.5/6.5	Volts
Operating and Storage Temperature Range	TJ, TSTG	-55 to + 150	°C
Typical Current Squared Time	I <sup>2</sup> t	6.64	A <sup>2</sup> /Sec

2016-09  
REV:A

- NOTES : 1. Non-repetitive current pulse, per Fig.3 and derated above TA = 25°C per Fig.2.  
2. Mounted on 1.6 X 1.6" ( 40 X 40mm ) per Fig. 5  
3. VF = 3.0V max. for devices of V(BR) ≤ 220V and VF = 6.5 Volts max. for devices of V(BR) > 220V.  
4. "Fully ROHS compliant", "100% Sn plating (Pb-free)".

# RATING AND CHARACTERISTIC CURVES( P4KE6.8 THRU P4KE440CA)

FIG. 1 - PEAK PULSE POWER RATING CURVE

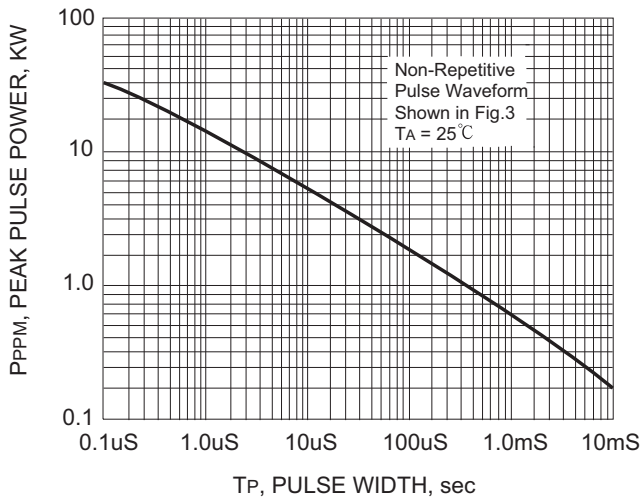

FIG. 2 - PULSE DERATING CURVE

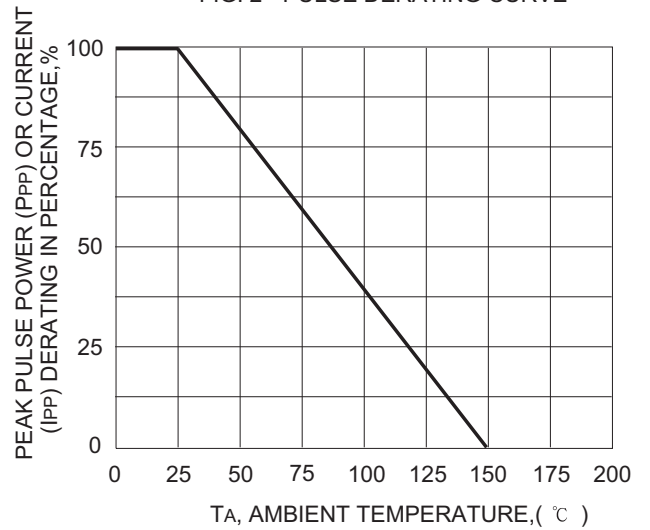

FIG. 3 - PULSE WAVEFORM

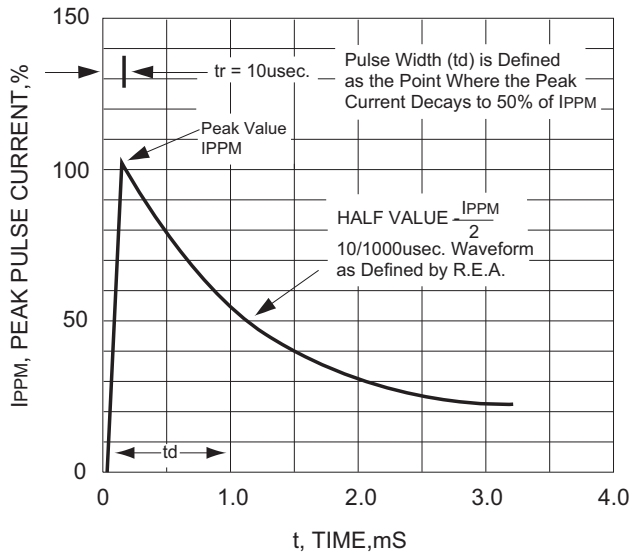
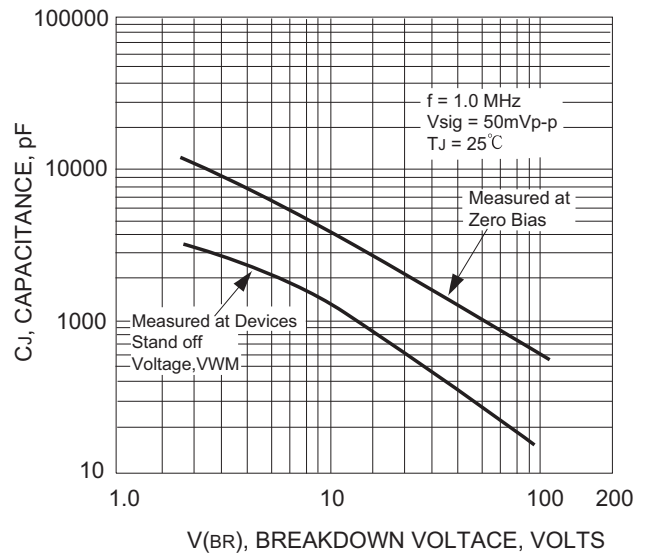

FIG. 4 - TYPICAL JUNCTION CAPACITANCE



# RATING AND CHARACTERISTIC CURVES( P4KE6.8 THRU P4KE440CA)

FIG. 5 - STEADY STATE POWER DERATING CURVE

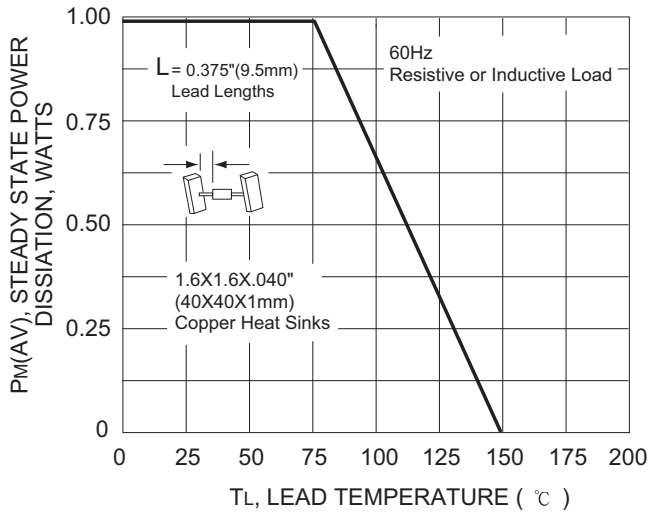

FIG. 6 - MAXIMUM NON-REPETITIVE FORWARD SURGE CURRENT UNIDIRECTIONAL

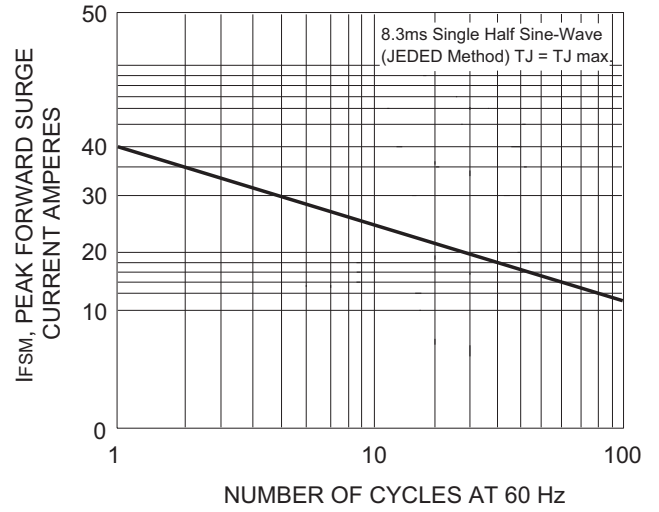
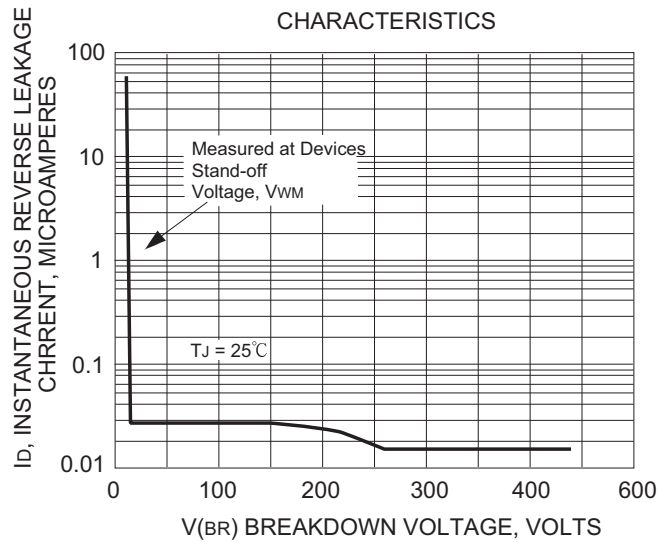

FIG. 7 - TYPICAL REVERSE LEAKAGE CHARACTERISTICS



## TRANSIENT VOLTAGE SUPPRESSORS

### 400W SERIES TVS DIODES / DO-41 ( CASE 7 ) 400W

TYPE	Breakdown Voltage		@I <sub>T</sub> (mA)	Reverse Stand off Voltage V <sub>WM</sub> (Volts)	Maximum Reverse Leakage at V <sub>WM</sub> I <sub>D</sub> (uA)	Maximum Peak Pulse Current I <sub>PPM</sub> (Amps)	Maximum Clamping Voltage at I <sub>PPM</sub> V <sub>C</sub> (Volts)
	V <sub>BR</sub> (Volts)						
	MIN.	MAX.					
P4KE6.8	6.12	7.48	10	5.50	1000	37	10.8
P4KE6.8A	6.45	7.14	10	5.80	1000	38.1	10.5
P4KE7.5	6.75	8.25	10	6.05	500	34.2	11.7
P4KE7.5A	7.13	7.88	10	6.40	500	35.4	11.3
P4KE8.2	7.38	9.02	10	6.63	200	32	12.5
P4KE8.2A	7.79	8.61	10	7.02	200	33.1	12.1
P4KE9.1	8.19	10.0	1.0	7.37	50	29	13.8
P4KE9.1A	8.65	9.55	1.0	7.78	50	29.9	13.4
P4KE10	9.00	11.0	1.0	8.10	10	26.7	15.0
P4KE10A	9.50	10.5	1.0	8.55	10	27.6	14.5
P4KE11	9.90	12.1	1.0	8.92	5.0	24.7	16.2
P4KE11A	10.5	11.6	1.0	9.40	5.0	25.6	15.6
P4KE12	10.8	13.2	1.0	9.72	5.0	23.1	17.3
P4KE12A	11.4	12.6	1.0	10.2	5.0	24	16.7
P4KE13	11.7	14.3	1.0	10.5	5.0	21.1	19.0
P4KE13A	12.4	13.7	1.0	11.1	5.0	22	18.2
P4KE15	13.5	16.5	1.0	12.1	5.0	18.2	22.0
P4KE15A	14.3	15.8	1.0	12.8	5.0	18.9	21.2
P4KE16	14.4	17.6	1.0	12.9	5.0	17	23.5
P4KE16A	15.2	16.8	1.0	13.6	5.0	17.8	22.5
P4KE18	16.2	19.8	1.0	14.5	5.0	15.1	26.5
P4KE18A	17.1	18.9	1.0	15.3	5.0	15.9	25.2
P4KE20	18.0	22.0	1.0	16.2	5.0	13.7	29.1
P4KE20A	19.0	21.0	1.0	17.1	5.0	14.4	27.7
P4KE22	19.8	24.2	1.0	17.8	5.0	12.5	31.9
P4KE22A	20.9	23.1	1.0	18.8	5.0	13.1	30.6
P4KE24	21.6	26.4	1.0	19.4	5.0	11.5	34.7
P4KE24A	22.8	25.2	1.0	20.5	5.0	12	33.2
P4KE27	24.3	29.7	1.0	21.8	5.0	10.2	39.1
P4KE27A	25.7	28.4	1.0	23.1	5.0	10.7	37.5
P4KE30	27.0	33.0	1.0	24.3	5.0	9.2	43.5
P4KE30A	28.5	31.5	1.0	25.6	5.0	9.7	41.4
P4KE33	29.7	36.3	1.0	26.8	5.0	8.4	47.7
P4KE33A	31.4	34.7	1.0	28.2	5.0	8.8	45.7
P4KE36	32.4	39.6	1.0	29.1	5.0	7.7	52.0
P4KE36A	34.2	37.8	1.0	30.8	5.0	8.0	49.9
P4KE39	35.1	42.9	1.0	31.6	5.0	7.1	56.4
P4KE39A	37.1	41.0	1.0	33.3	5.0	7.4	53.9
P4KE43	38.7	47.3	1.0	34.8	5.0	6.5	61.9
P4KE43A	40.9	45.2	1.0	36.8	5.0	6.7	59.3
P4KE47	42.3	51.7	1.0	38.1	5.0	5.9	67.8
P4KE47A	44.7	49.4	1.0	40.2	5.0	6.2	64.8
P4KE51	45.9	56.1	1.0	41.3	5.0	5.4	73.5
P4KE51A	48.5	53.6	1.0	43.6	5.0	5.7	70.1
P4KE56	50.4	61.6	1.0	45.4	5.0	5.0	80.5
P4KE56A	53.2	58.8	1.0	47.8	5.0	5.2	77.0

## TRANSIENT VOLTAGE SUPPRESSORS

### 400W SERIES TVS DIODES / DO-41 ( CASE 7 ) 400W

TYPE	Breakdown Voltage		@I <sub>T</sub> (mA)	Reverse Stand off Voltage V <sub>WM</sub> (Volts)	Maximum Reverse Leakage at V <sub>WM</sub> I <sub>D</sub> (uA)	Maximum Peak Pulse Current I <sub>PPM</sub> (Amps)	Maximum Clamping Voltage at I <sub>PPM</sub> V <sub>C</sub> (Volts)
	V <sub>BR</sub> (Volts)						
	MIN.	MAX.					
P4KE62	55.8	68.2	1.0	50.2	5.0	4.5	89.0
P4KE62A	58.9	65.1	1.0	53.0	5.0	4.7	85.0
P4KE68	61.2	74.8	1.0	55.1	5.0	4.1	98.0
P4KE68A	64.6	71.4	1.0	58.1	5.0	4.3	92.0
P4KE75	67.5	82.5	1.0	60.7	5.0	3.7	108
P4KE75A	71.3	78.8	1.0	64.1	5.0	3.9	103
P4KE82	73.8	90.2	1.0	66.4	5.0	3.4	118
P4KE82A	77.9	86.1	1.0	70.1	5.0	3.5	113
P4KE91	81.9	100	1.0	73.7	5.0	3.1	131
P4KE91A	86.5	95.5	1.0	77.8	5.0	3.2	125
P4KE100	90.0	110	1.0	81.0	5.0	2.8	144
P4KE100A	95.0	105	1.0	85.5	5.0	2.9	137
P4KE110	99.0	121	1.0	89.2	5.0	2.5	158
P4KE110A	105	116	1.0	94.0	5.0	2.6	152
P4KE120	108	132	1.0	97.2	5.0	2.3	173
P4KE120A	114	126	1.0	102	5.0	2.4	165
P4KE130	117	143	1.0	105	5.0	2.1	187
P4KE130A	124	137	1.0	111	5.0	2.2	179
P4KE150	135	165	1.0	121	5.0	1.9	215
P4KE150A	143	158	1.0	128	5.0	1.9	207
P4KE160	144	176	1.0	130	5.0	1.7	230
P4KE160A	152	168	1.0	136	5.0	1.8	219
P4KE170	153	187	1.0	138	5.0	1.6	244
P4KE170A	162	179	1.0	145	5.0	1.7	234
P4KE180	162	198	1.0	146	5.0	1.6	258
P4KE180A	171	189	1.0	154	5.0	1.6	246
P4KE200	180	220	1.0	162	5.0	1.4	287
P4KE200A	190	210	1.0	171	5.0	1.5	274
P4KE220	198	242	1.0	175	5.0	1.2	344
P4KE220A	209	231	1.0	185	5.0	1.2	328
P4KE250	225	275	1.0	202	5.0	1.1	360
P4KE250A	237	263	1.0	214	5.0	1.2	344
P4KE300	270	330	1.0	243	5.0	0.93	430
P4KE300A	285	315	1.0	256	5.0	1.00	414
P4KE350	315	385	1.0	284	5.0	0.79	504
P4KE350A	333	368	1.0	300	5.0	0.83	482
P4KE400	360	440	1.0	324	5.0	0.70	574
P4KE400A	380	420	1.0	342	5.0	0.73	548
P4KE440	396	484	1.0	356	5.0	0.63	631
P4KE440A	418	462	1.0	376	5.0	0.66	602

- Notes :
1. V<sub>BR</sub> measured after I<sub>T</sub> applied for 300ms. I<sub>T</sub> = square pulse or equivalent.
  2. For bidirectional use C or CA suffixs for all types (ex. P4KE6.8C,P4KE440CA) electrical characteristics apply in both directions.
  3. For bidirectional types having V<sub>WM</sub> of 10 volts and less, the I<sub>D</sub> limit is doubled.

## Marking Description

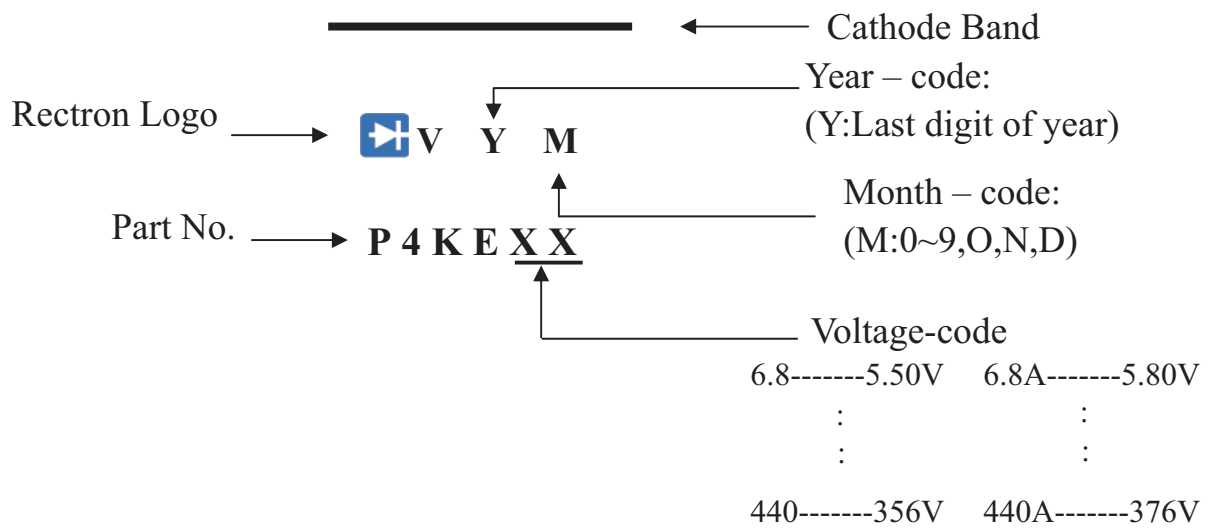

## PACKAGING OF DIODE AND BRIDGE RECTIFIERS

### BULK PACK

PACKAGE	PACKING CODE	EA PER BOX	INNER BOX SIZE (mm)	CARTON SIZE (mm)	EA PER CARTON	GROSS WEIGHT(Kg)
DO-41	-B	1,000	194*75*21	415*220*255	50,000	16.2

### REEL PACK

PACKAGE	PACKING CODE	EA PER REEL	EA PER INNER BOX	COMPONENT SPACE (mm)	TAPE SPACE (mm)	REEL DIA (mm)	CARTON SIZE (mm)	EA PER CARTON	GROSS WEIGHT(Kg)
DO-41	-T	5,000	5,000	5.0	52	330	355*350*335	20,000	10.49

### AMMO PACK

PACKAGE	PACKING CODE	REEL ( EA )	COMPONENT SPACE(mm)	TAPE SPACE (mm)	BOX SIZE (mm)	CARTON SIZE(mm)	CARTON ( EA )	GROSS WEIGHT (Kg)
DO-41	-F	3,000	5.0	52	255*73*100	400*268*225	30,000	13.0
DO-41	-E	3,000	5.0	26	256*48*94	365*270*217	42,000	12.41