

P6SMB

600 W Transient voltage suppressor

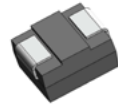

Product features

- Low profile SMB package
- Excellent clamping capability
- 600 W peak pulse power capability at 10/1000 μ s waveform
- Typical I_R less than 1 μ A above 12 V
- Fast response time: typically less than 1.0 ps from 0 V to V_{BR} minimum
- High temperature reflow soldering: +260 °C /40 s at terminal
- Plastic package meets UL 94 V-0 flammability rating
- Meets moisture sensitivity level (MSL) level 1
- Terminal: Solder plated leads, solderable per J-STD-002
- For surface mounted applications in order to optimize board space
- UL 497B recognized.
File No. : E198449 Guide QVGO2

Applications

- Consumer electronics
- Telecommunications
- Computing and servers
- Appliances
- Industrial automation
- Mobile and wearables

Environmental compliance and general specifications



Ordering part number

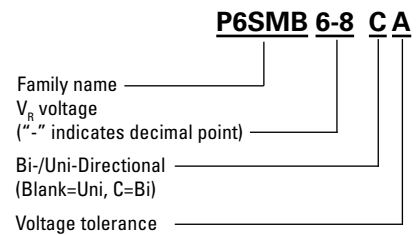

PIN configuration

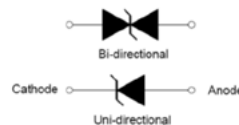
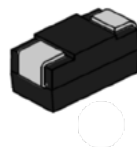

Absolute maximum ratings

(+25 °C, RH=45%-75%, unless otherwise noted)

Parameter	Symbol	Value	Unit
Storage operating junction temperature range	T_{STG}/T_J	-55 to +150	°C
Steady state power dissipation at $T_L = +75$ °C	$P_{M(AV)}$	5.0	W
Peak pulse power dissipation on 10/1000 μ s waveform	P_{PP}	600	W
Maximum instantaneous forward voltage at 100 A for unidirectional	V_F	5.0	V
Peak forward surge current, 8.3 ms single half sine wave ¹	I_{FSM}	100	A
Typical thermal resistance junction to lead	$R_{\theta JL}$	20	°C/W
Typical thermal resistance junction to ambient	$R_{\theta JA}$	100	°C/W

1. Measured on 8.3 ms single half sine wave or equivalent square wave for unidirectional device only, duty cycle = 4 per minute maximum

Mechanical parameters, pad layout- mm

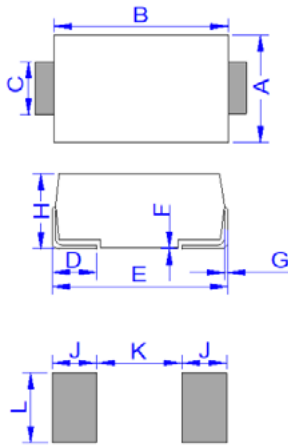

Dimension	Millimeters		Inches	
	Minimum	Maximum	Minimum	Maximum
A	3.30	3.94	0.130	0.155
B	4.30	4.80	0.169	0.189
C	1.90	2.20	0.075	0.087
D	0.95	1.52	0.037	0.060
E	5.20	5.60	0.205	0.220
F	0.051	0.203	0.002	0.008
G	0.15	0.31	0.006	0.012
H	2.10	2.40	0.083	0.094
J	2.20		0.087	
K		2.60		0.102
L	2.30		0.091	

Part marking



Cathode band (Uni-polar only)

Part marking: xxxx = Date code
yyyy- Refer to marking designator listed in Electrical Characteristics table

Packaging information (mm)

Drawing not to scale.

Supplied in tape and reel packaging, 3,000 parts per 13" diameter reel (EIA-481 compliant)

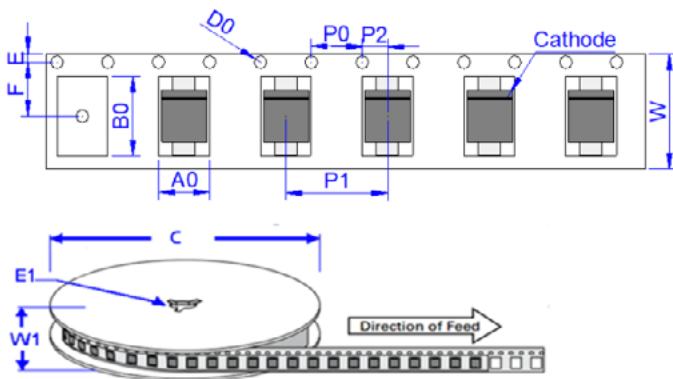

Dimension	Millimeters	Inches
A0	3.76 ± 0.3	0.148 ± 0.012
B0	5.69 ± 0.3	0.224 ± 0.012
C	330.0	13.0
D0	1.55 ± 0.1	0.061 ± 0.004
E	1.75 ± 0.2	0.069 ± 0.008
E1	13.3 ± 0.3	0.524 ± 0.012
F	5.5 ± 0.2	0.217 ± 0.008
P0	4.00 ± 0.2	0.157 ± 0.008
P1	8.00 ± 0.2	0.315 ± 0.008
P2	2.00 ± 0.2	0.079 ± 0.008
W	12.0 ± 0.2	0.472 ± 0.008
W1	15.7 ± 2.0	0.618 ± 0.079

Electrical characteristics (+25 °C)

Part number	Uni-polar	Bi-polar	Marking		V_R (V)	$I_R @ V_R$ (μ A)	$V_{BR} @ I_T$ min (V)	max (V)	I_T (mA)	$V_C @ I_{PP}$ max (V)	I_{PP} (A)
			Uni	Bi							
P6SMB6-8A	P6SMB6-8CA	6V8A	6V8C	5.8	150	6.45	7.14	10	10.5	58.1	
P6SMB7-5A	P6SMB7-5CA	7V5A	7V5C	6.4	120	7.13	7.88	10	11.3	54	
P6SMB8-2A	P6SMB8-2CA	8V2A	8V2C	7.02	50	7.79	8.61	10	12.1	50.4	
P6SMB9-1A	P6SMB9-1CA	9V1A	9V1C	7.78	20	8.65	9.55	1	13.4	45.5	
P6SMB10A	P6SMB10CA	10A	10C	8.55	10	9.5	10.5	1	14.5	42.1	
P6SMB11A	P6SMB11CA	11A	11C	9.4	5	10.5	11.6	1	15.6	39.1	
P6SMB12A	P6SMB12CA	12A	12C	10.2	2	11.4	12.6	1	16.7	36.5	
P6SMB13A	P6SMB13CA	13A	13C	11.1	1	12.4	13.7	1	18.2	33.5	
P6SMB15A	P6SMB15CA	15A	15C	12.8	1	14.3	15.8	1	21.2	28.8	
P6SMB16A	P6SMB16CA	16A	16C	13.6	1	15.2	16.8	1	22.5	27.1	
P6SMB18A	P6SMB18CA	18A	18C	15.3	1	17.1	18.9	1	25.2	24.2	
P6SMB20A	P6SMB20CA	20A	20C	17.1	1	19	21	1	27.7	21.7	
P6SMB22A	P6SMB22CA	22A	22C	18.8	1	20.9	23.1	1	30.6	19.7	
P6SMB24A	P6SMB24CA	24A	24C	20.5	1	22.8	25.2	1	33.2	18.4	
P6SMB27A	P6SMB27CA	27A	27C	23.1	1	25.7	28.4	1	37.5	16.3	
P6SMB30A	P6SMB30CA	30A	30C	25.6	1	28.5	31.5	1	41.4	14.7	
P6SMB33A	P6SMB33CA	33A	33C	28.2	1	31.4	34.7	1	45.7	13.3	
P6SMB36A	P6SMB36CA	36A	36C	30.8	1	34.2	37.8	1	49.9	12.2	
P6SMB39A	P6SMB39CA	39A	39C	33.3	1	37.1	41	1	53.9	11.3	
P6SMB43A	P6SMB43CA	43A	43C	36.8	1	40.9	45.2	1	59.3	10.3	
P6SMB47A	P6SMB47CA	47A	47C	40.2	1	44.7	49.4	1	64.8	9.4	
P6SMB51A	P6SMB51CA	51A	51C	43.6	1	48.5	53.6	1	70.1	8.7	
P6SMB56A	P6SMB56CA	56A	56C	47.8	1	53.2	58.8	1	77	7.9	
P6SMB62A	P6SMB62CA	62A	62C	53	1	58.9	65.1	1	85	7.2	
P6SMB68A	P6SMB68CA	68A	68C	58.1	1	64.6	71.4	1	92	6.6	
P6SMB75A	P6SMB75CA	75A	75C	64.1	1	71.3	78.8	1	103	5.9	
P6SMB82A	P6SMB82CA	82A	82C	70.1	1	77.9	86.1	1	113	5.4	
P6SMB91A	P6SMB91CA	91A	91C	77.8	1	86.5	95.5	1	125	4.9	
P6SMB100A	P6SMB100CA	100A	100C	85.5	1	95	105	1	137	4.5	
P6SMB110A	P6SMB110CA	110A	110C	94	1	105	116	1	152	4	
P6SMB120A	P6SMB120CA	120A	120C	102	1	114	126	1	165	3.7	
P6SMB130A	P6SMB130CA	130A	130C	111	1	124	137	1	179	3.4	
P6SMB150A	P6SMB150CA	150A	150C	128	1	143	158	1	207	2.9	
P6SMB160A	P6SMB160CA	160A	160C	136	1	152	168	1	219	2.8	
P6SMB170A	P6SMB170CA	170A	170C	145	1	162	179	1	234	2.6	
P6SMB180A	P6SMB180CA	180A	180C	154	1	171	189	1	246	2.5	
P6SMB200A	P6SMB200CA	200A	200C	171	1	190	210	1	274	2.2	
P6SMB220A	P6SMB220CA	220A	220C	185	1	209	231	1	328	1.9	
P6SMB250A	P6SMB250CA	250A	250C	214	1	237	263	1	344	1.8	
P6SMB300A	P6SMB300CA	300A	300C	256	1	285	315	1	414	1.5	
P6SMB350A	P6SMB350CA	350A	350C	300	1	332	368	1	482	1.3	
P6SMB400A	P6SMB400CA	400A	400C	342	1	380	420	1	548	1.1	
P6SMB440A	P6SMB440CA	440A	440C	376	1	418	462	1	602	1	
P6SMB480A	P6SMB480CA	480A	480C	408	1	456	504	1	658	0.9	
P6SMB510A	P6SMB510CA	510A	510C	434	1	485	535	1	698	0.9	
P6SMB540A	P6SMB540CA	540A	540C	460	1	513	567	1	740	0.8	
P6SMB600A	P6SMB600CA	600A	600C	512	1	570	630	1	828	0.75	

Ratings and V-I characteristic curves (+25 °C unless otherwise noted)

V- I curve characteristics (Uni-directional)

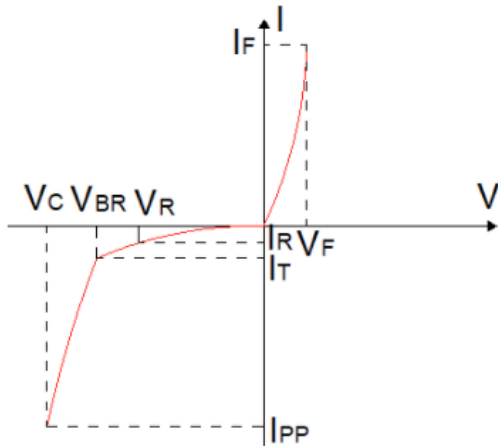

V- I curve characteristics (Bi-directional)

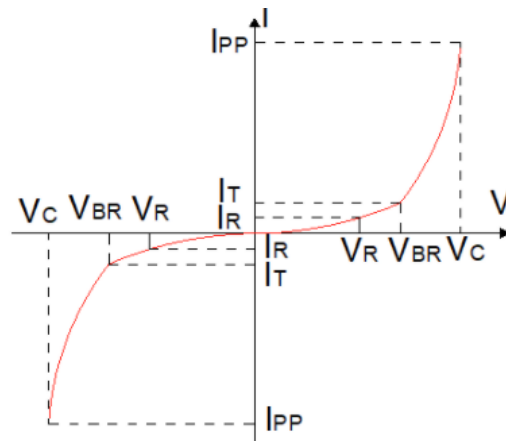

Surge waveform: 10/1000 μ s

V_R : Stand-off voltage – Maximum voltage that can be applied

V_{BR} : Breakdown voltage

V_C : Clamping voltage – Peak voltage measured across the suppressor at a specified I_{PP}

I_R : Reverse leakage current

I_T : Test current

V_F : Forward voltage drop for Uni-directional TVS diode

Pulse waveform

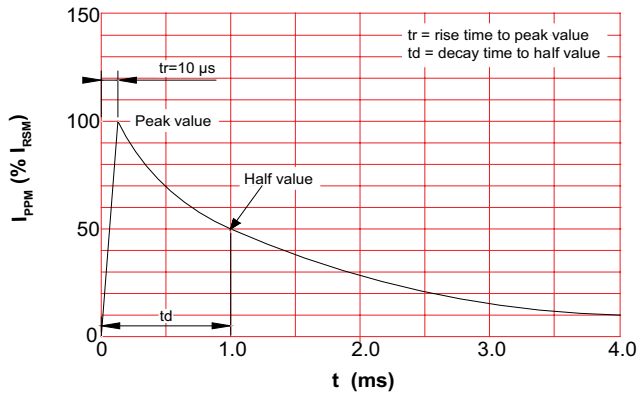

Pulse derating curve

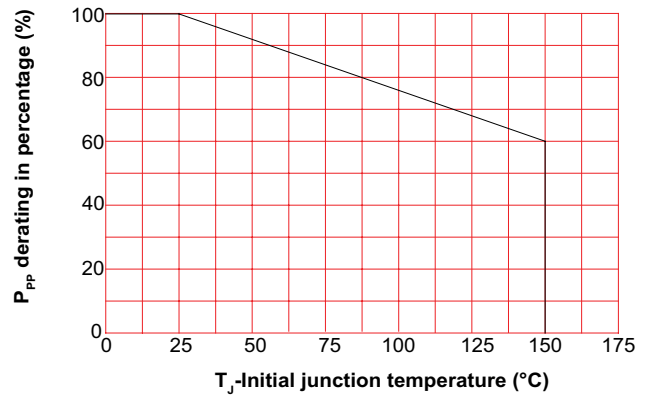

Peak pulse power dissipation vs. pulse width

