

### 1. General description

P6SMBJ series, 600W transient voltage suppressor (TVS) in SMB package, designed to protect electronic circuits against damage induced by lightning surges or other transient voltage events.

### 2. Features and benefits

- Peak pulse power 600W @ 10/1000 $\mu$ s waveform
- Excellent clamping capability
- Low incremental surge resistance
- Surface mount package for easy assembly and PCB space-saving
- Typical  $I_R < 1\mu$ A when  $V_{BR\ min} > 12$ V
- Fast response time: typically  $< 1.0$ ps from 0V to  $V_{BR}$  minimum
- IEC 61000-4-2 ESD 30kV (Air), 30kV (Contact)
- EFT protection of data lines in accordance with IEC 61000-4-4
- Guaranteed high temperature for reflow soldering: 260 $^{\circ}$ C/10sec
- Mold compound complies to UL94V-0 flammability classification
- Meets MSL level 1, per J-STD-020
- Pb-free lead finish
- Halogen free and RoHS compliant



Bi-directional

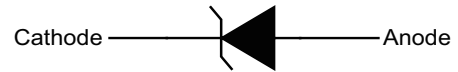

Uni-directional

### 3. Applications

- Power supplies
- Industrial applications
- Power management circuits
- I/O interfaces



### 4. Ordering information

Type number	Package name	Orderable part number	Packing method	Small packing quantity	Package version	Package issue date
P6SMBJxxxXX	SMB	P6SMBJxxxXXJ	Tape and reel	3000	SMBJ	18-Oct-2020
eg. P6SMBJ5.0CA	SMB	P6SMBJ5.0CAJ	Tape and reel	3000	SMBJ	18-Oct-2020

### 5. Absolute maximum ratings

In accordance with the Absolute Maximum Rating System (IEC 60134).

$T_j = 25\text{ }^{\circ}\text{C}$  unless otherwise specified.

Symbol	Parameter	Conditions	Values	Unit
<b>Absolute maximum rating</b>				
$P_{PPM}$	peak pulse power	[1]	600	W
$P_{M(AV)}$	steady state power dissipation	on infinite heatsink at $T_a = 50\text{ }^{\circ}\text{C}$	5	W
$I_{FSM}$	peak forward surge current	$t_p = 8.3\text{ ms}$ ; single half sine-wave pulse; duty cycle = 4 pulses per minute maximum; unidirectional units only	100	A
$V_F$	forward on-state voltage	$I_F = 50\text{ A}$ ; unidirectional units only	3.5	V
$T_{stg}$	storage temperature range		-65 to 150	$^{\circ}\text{C}$
$T_j$	operating temperature range		-65 to 150	$^{\circ}\text{C}$

[1] In accordance with IEC 61643-321 (10/1000  $\mu$ s current waveform).

## 6. Characteristics

$T_j = 25\text{ }^\circ\text{C}$  unless otherwise specified.

PN (Uni)	PN (Bi)	Reverse Stand off Voltage $V_R$ (V)	Breakdown Voltage $V_{BR} @ I_T$ (V)		Test current $I_T$ (mA)	Max. Clamping Voltage $V_C @ I_{pp}$ (V)	Max. Peak Pulse Current $I_{pp}$ (A)	Maximum Reverse Leakage $I_R @ V_R$ ( $\mu$ A)	Marking		
			Min	Max					Uni	Bi	
P6SMBJ5.0A	P6SMBJ5.0CA	5	6.45	6.98	10	9.2	65.3	400		6B005J	6B005J
P6SMBJ6.0A	P6SMBJ6.0CA	6	6.8	7.32	10	10.3	58.3	400		6B006J	6B006J
P6SMBJ6.5A	P6SMBJ6.5CA	6.5	7.27	7.92	10	11.2	53.6	250		6B06FJ	6B06FJ
P6SMBJ7.0A	P6SMBJ7.0CA	7	7.82	8.57	10	12	50	100		6B007J	6B007J
P6SMBJ8.0A	P6SMBJ8.0CA	8	8.95	9.76	1	13.6	44.2	50		6B008J	6B008J
P6SMBJ9.0A	P6SMBJ9.0CA	9	10.1	11	1	15.4	39	10		6B009J	6B009J
P6SMBJ10A	P6SMBJ10CA	10	11.21	12.19	1	17	35.3	5		6B010J	6B010J
P6SMBJ11A	P6SMBJ11CA	11	12.32	13.38	1	18.2	33	1		6B011J	6B011J
P6SMBJ12A	P6SMBJ12CA	12	13.43	14.57	1	19.9	30.2	1		6B012J	6B012J
P6SMBJ13A	P6SMBJ13CA	13	14.54	15.76	1	21.5	28	1		6B013J	6B013J
P6SMBJ14A	P6SMBJ14CA	14	15.75	17.04	1	23.2	25.9	1		6B014J	6B014J
P6SMBJ15A	P6SMBJ15CA	15	16.86	18.34	1	24.4	24.6	1		6B015J	6B015J
P6SMBJ16A	P6SMBJ16CA	16	17.97	19.52	1	26	23.1	1		6B016J	6B016J
P6SMBJ17A	P6SMBJ17CA	17	19.08	20.72	1	27.6	21.8	1		6B017J	6B017J
P6SMBJ18A	P6SMBJ18CA	18	20.19	21.9	1	29.2	20.6	1		6B018J	6B018J
P6SMBJ20A	P6SMBJ20CA	20	22.41	24.28	1	32.4	18.6	1		6B020J	6B020J
P6SMBJ22A	P6SMBJ22CA	22	24.63	26.66	1	35.5	16.9	1		6B022J	6B022J
P6SMBJ24A	P6SMBJ24CA	24	26.95	29.23	1	38.9	15.5	1		6B024J	6B024J
P6SMBJ26A	P6SMBJ26CA	26	29.12	31.67	1	42.1	14.3	1		6B026J	6B026J
P6SMBJ28A	P6SMBJ28CA	28	31.33	34.16	1	45.4	13.3	1		6B028J	6B028J
P6SMBJ30A	P6SMBJ30CA	30	33.55	36.54	1	48.4	12.4	1		6B030J	6B030J
P6SMBJ33A	P6SMBJ33CA	33	36.98	40.3	1	53.3	11.3	1		6B033J	6B033J
P6SMBJ36A	P6SMBJ36CA	36	40.3	43.9	1	58.1	10.4	1		6B036J	6B036J
P6SMBJ40A	P6SMBJ40CA	40	44.7	48.8	1	64.5	9.3	1		6B040J	6B040J
P6SMBJ43A	P6SMBJ43CA	43	48.2	52.4	1	69.4	8.7	1		6B043J	6B043J
P6SMBJ45A	P6SMBJ45CA	45	50.4	54.9	1	72.7	8.3	1		6B045J	6B045J
P6SMBJ48A	P6SMBJ48CA	48	53.7	58.5	1	77.4	7.8	1		6B048J	6B048J
P6SMBJ51A	P6SMBJ51CA	51	57.1	62.3	1	82.4	7.3	1		6B051J	6B051J
P6SMBJ54A	P6SMBJ54CA	54	60.5	65.8	1	87.1	6.9	1		6B054J	6B054J
P6SMBJ58A	P6SMBJ58CA	58	64.9	70.7	1	93.6	6.5	1		6B058J	6B058J
P6SMBJ60A	P6SMBJ60CA	60	67.2	73.2	1	96.8	6.2	1		6B060J	6B060J
P6SMBJ64A	P6SMBJ64CA	64	71.6	78	1	103	5.9	1		6B064J	6B064J
P6SMBJ70A	P6SMBJ70CA	70	78.4	85.4	1	113	5.3	1		6B070J	6B070J
P6SMBJ75A	P6SMBJ75CA	75	83.9	91.5	1	121	5	1		6B075J	6B075J
P6SMBJ78A	P6SMBJ78CA	78	87.4	95.1	1	126	4.8	1		6B078J	6B078J
P6SMBJ85A	P6SMBJ85CA	85	95.1	103.3	1	137	4.4	1		6B085J	6B085J

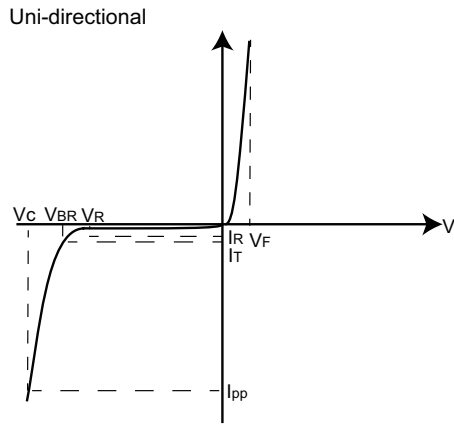

**Fig. 1. I-V curve characteristics; Uni-directional**

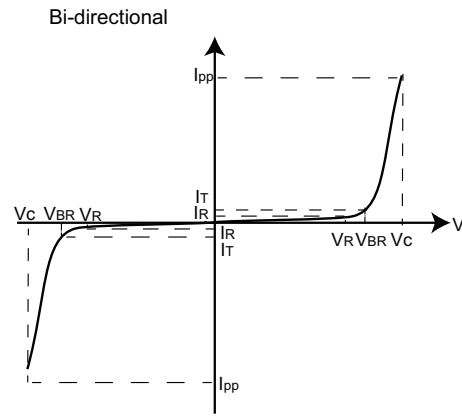

**Fig. 2. I-V curve characteristics; Bi-directional**



**Fig. 3. Peak pulse power derating curve**

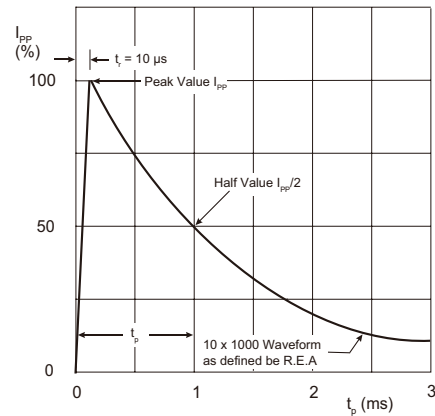

**Fig. 4. Pulse waveform**

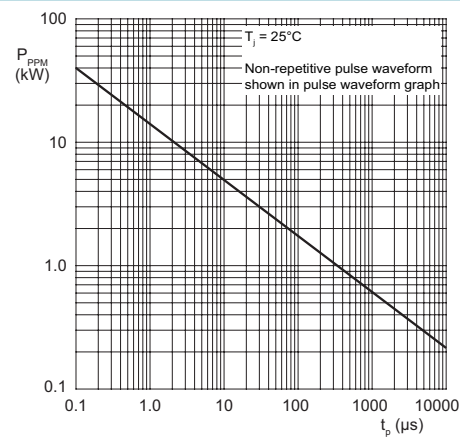

**Fig. 5. Peak pulse power rating curve**

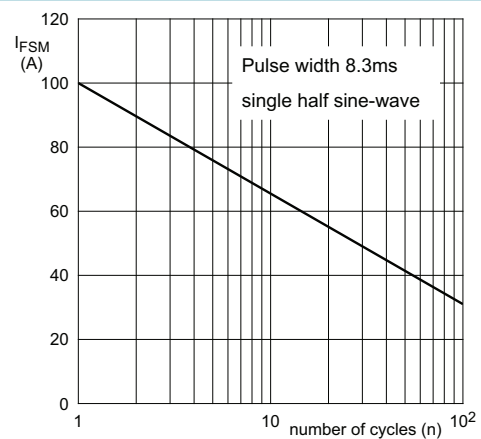

**Fig. 6. Maximum non-repetitive surge current Uni-directional only**

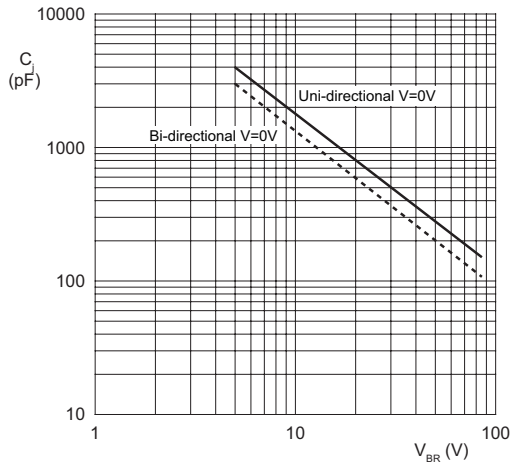

**Fig. 7. Typical junction capacitance**



**Fig. 8. Part numbering**

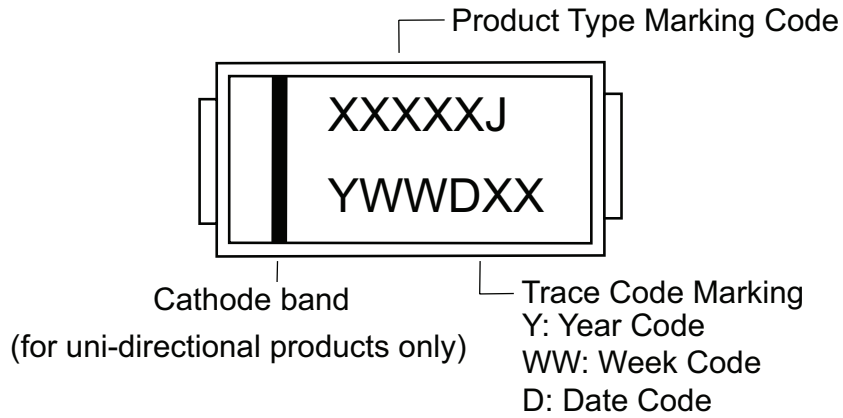

**Fig. 9. Part marking**

**7. Package outline**

SMB

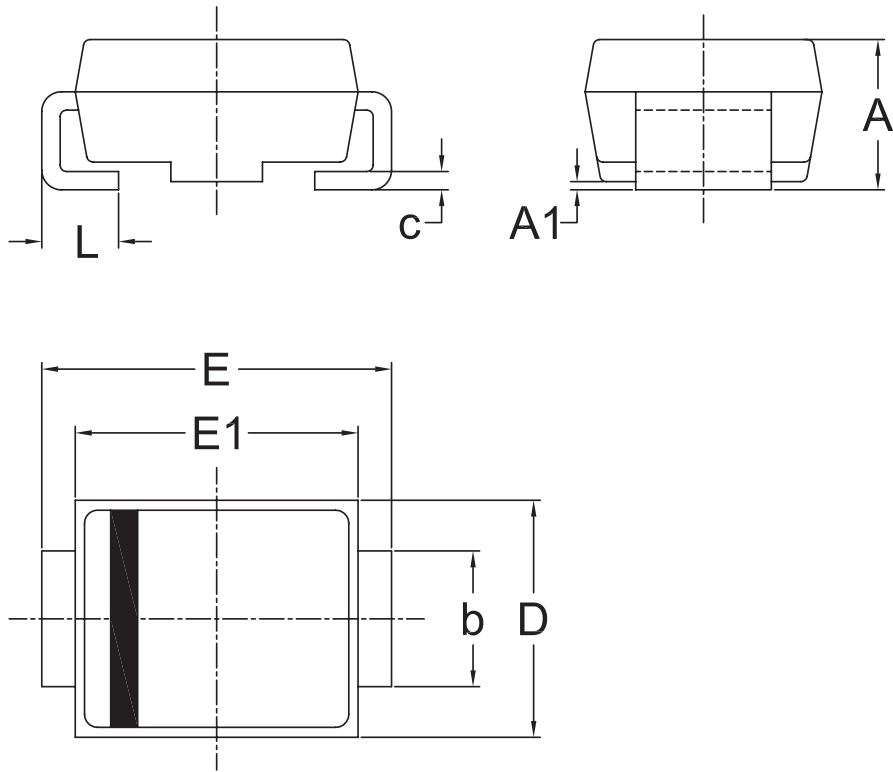

UNIT	A	A1	b	c	D	E	E1	L	
mm	Max	2.50	0.30	2.15	0.25	3.75	5.54	4.65	1.50
	Min	2.00	0.00	1.85	0.15	3.45	5.04	4.35	0.80

Remark: Dimensions D and E1 do not include mold flash & gate remain.

## 8. Legal information

### Data sheet status

Document status [1][2]	Product status [3]	Definition
Objective [short] data sheet	Development	This document contains data from the objective specification for product development.
Preliminary [short] data sheet	Qualification	This document contains data from the preliminary specification.
Product [short] data sheet	Production	This document contains the product specification.

- [1] Please consult the most recently issued document before initiating or completing a design.
- [2] The term 'short data sheet' is explained in section "Definitions".
- [3] The product status of device(s) described in this document may have changed since this document was published and may differ in case of multiple devices. The latest product status information is available on the Internet at URL <http://www.ween-semi.com>.

### Definitions

**Draft** — The document is a draft version only. The content is still under internal review and subject to formal approval, which may result in modifications or additions. WeEn Semiconductors does not give any representations or warranties as to the accuracy or completeness of information included herein and shall have no liability for the consequences of use of such information.

**Short data sheet** — A short data sheet is an extract from a full data sheet with the same product type number(s) and title. A short data sheet is intended for quick reference only and should not be relied upon to contain detailed and full information. For detailed and full information see the relevant full data sheet, which is available on request via the local WeEn Semiconductors sales office. In case of any inconsistency or conflict with the short data sheet, the full data sheet shall prevail.

**Product specification** — The information and data provided in a Product data sheet shall define the specification of the product as agreed between WeEn Semiconductors and its customer, unless WeEn Semiconductors and customer have explicitly agreed otherwise in writing. In no event however, shall an agreement be valid in which the WeEn Semiconductors product is deemed to offer functions and qualities beyond those described in the Product data sheet.

### Disclaimers

**Limited warranty and liability** — Information in this document is believed to be accurate and reliable. However, WeEn Semiconductors does not give any representations or warranties, expressed or implied, as to the accuracy or completeness of such information and shall have no liability for the consequences of use of such information. WeEn Semiconductors takes no responsibility for the content in this document if provided by an information source outside of WeEn Semiconductors.

In no event shall WeEn Semiconductors be liable for any indirect, incidental, punitive, special or consequential damages (including - without limitation - lost profits, lost savings, business interruption, costs related to the removal or replacement of any products or rework charges) whether or not such damages are based on tort (including negligence), warranty, breach of contract or any other legal theory.

Notwithstanding any damages that customer might incur for any reason whatsoever, WeEn Semiconductors' aggregate and cumulative liability towards customer for the products described herein shall be limited in accordance with the *Terms and conditions of commercial sale* of WeEn Semiconductors.

**Right to make changes** — WeEn Semiconductors reserves the right to make changes to information published in this document, including without limitation specifications and product descriptions, at any time and without notice. This document supersedes and replaces all information supplied prior to the publication hereof.

**Suitability for use** — WeEn Semiconductors products are not designed, authorized or warranted to be suitable for use in life support, life-critical or safety-critical systems or equipment, nor in applications where failure or malfunction of an WeEn Semiconductors product can reasonably be expected to result in personal injury, death or severe property or environmental damage. WeEn Semiconductors and its suppliers accept no liability for inclusion and/or use of WeEn Semiconductors products in such equipment or applications and therefore such inclusion and/or use is at the customer's own risk.

**Quick reference data** — The Quick reference data is an extract of the product data given in the Limiting values and Characteristics sections of this document, and as such is not complete, exhaustive or legally binding.

**Applications** — Applications that are described herein for any of these products are for illustrative purposes only. WeEn Semiconductors makes no representation or warranty that such applications will be suitable for the specified use without further testing or modification.

Customers are responsible for the design and operation of their applications and products using WeEn Semiconductors products, and WeEn Semiconductors accepts no liability for any assistance with applications or customer product design. It is customer's sole responsibility to determine whether the WeEn Semiconductors product is suitable and fit for the customer's applications and products planned, as well as for the planned application and use of customer's third party customer(s). Customers should provide appropriate design and operating safeguards to minimize the risks associated with their applications and products.

WeEn Semiconductors does not accept any liability related to any default, damage, costs or problem which is based on any weakness or default in the customer's applications or products, or the application or use by customer's third party customer(s). Customer is responsible for doing all necessary testing for the customer's applications and products using WeEn Semiconductors products in order to avoid a default of the applications and the products or of the application or use by customer's third party customer(s). WeEn does not accept any liability in this respect.

**Limiting values** — Stress above one or more limiting values (as defined in the Absolute Maximum Ratings System of IEC 60134) will cause permanent damage to the device. Limiting values are stress ratings only and (proper) operation of the device at these or any other conditions above those given in the Recommended operating conditions section (if present) or the Characteristics sections of this document is not warranted. Constant or repeated exposure to limiting values will permanently and irreversibly affect the quality and reliability of the device.

**No offer to sell or license** — Nothing in this document may be interpreted or construed as an offer to sell products that is open for acceptance or the grant, conveyance or implication of any license under any copyrights, patents or other industrial or intellectual property rights.

**Export control** — This document as well as the item(s) described herein may be subject to export control regulations. Export might require a prior authorization from competent authorities.

**Non-automotive qualified products** — Unless this data sheet expressly states that this specific WeEn Semiconductors product is automotive qualified, the product is not suitable for automotive use. It is neither qualified nor tested in accordance with automotive testing or application requirements. WeEn Semiconductors accepts no liability for inclusion and/or use of non-automotive qualified products in automotive equipment or applications.

In the event that customer uses the product for design-in and use in automotive applications to automotive specifications and standards, customer (a) shall use the product without WeEn Semiconductors' warranty of the product for such automotive applications, use and specifications, and (b) whenever customer uses the product for automotive applications beyond WeEn Semiconductors' specifications such use shall be solely at customer's own risk, and (c) customer fully indemnifies WeEn Semiconductors for any liability, damages or failed product claims resulting from customer design and use of the product for automotive applications beyond WeEn Semiconductors' standard warranty and WeEn Semiconductors' product specifications.