

# Streamline Series Vector Network Analyzer (B-models)

P937xB 2-port Up to 44 GHz

P938xB 4-port Up to 20 GHz

P500xB 2-port Up to 53 GHz

P502xB 4-port Up to 53 GHz / 6-port Up to 20 GHz

**Compact Form. Zero Compromise.**



## Keysight Streamline Series VNA

The freedom of portable network analysis doesn't have to mean a compromise in performance. The B-models of the Keysight Streamline Series VNAs unlock the full performance of the network analyzer hardware with fast measurements over Thunderbolt 3 connections to your host PC. Gain confidence in your measurements with best-in-class performance offering fast, reliable, and repeatable results. Explore the complete characterization of your devices with a rich portfolio of software applications that transform the compact network analyzer into a complete RF measurement solution.

The P50xxB series offers the performance required for testing passive components, amplifiers, mixers or frequency converters. The vector network analyzer (VNA) provides best-in-class key specifications such as dynamic range, measurement speed, trace noise and temperature stability. Choose from 2- or 4-port models up to 53 GHz, or 6-port models up to 20 GHz.



The P93xxB series provides excellent performance in general-purpose network analysis for passive components. With software applications like enhanced time domain analysis with TDR and automatic fixture removal, you can easily characterize passive components with the same performance of a benchtop setup. Choose from 2-port models up to 44 GHz or 4-port models up to 20 GHz.

The Streamline Series utilizes the same measurement science as other Keysight VNAs such as the PNA, ENA and PXI VNA. A common software platform makes it easy to choose the right level of performance to match budget and measurement needs. This commonality guarantees measurement consistency, repeatability, and a common remote-programming interface across multiple instruments in R&D and manufacturing.



P937xB Series	
P9370B	9 kHz to 4.5 GHz, 2-port
P9371B	9 kHz to 6.5 GHz, 2-port
P9372B	9 kHz to 9 GHz, 2-port
P9373B	9 kHz to 14 GHz, 2-port
P9374B	9 kHz to 20 GHz, 2-port
P9375B	100 kHz to 26.5 GHz, 2-port
P9377B	100 kHz to 44 GHz, 2-port



P938xB Series	
P9382B	9 kHz to 9 GHz, 4-port
P9384B	9 kHz to 20 GHz, 4-port



P500xB Series	
P5000B	9 kHz to 4.5 GHz, 2-port
P5001B	9 kHz to 6.5 GHz, 2-port
P5002B	9 kHz to 9 GHz, 2-port
P5003B	9 kHz to 14 GHz, 2-port
P5004B	9 kHz to 20 GHz, 2-port
P5005B	100 kHz to 26.5 GHz, 2-port
P5006B	100 kHz to 32 GHz, 2-port
P5007B	100 kHz to 44 GHz, 2-port
P5008B	100 kHz to 53 GHz, 2-port



P502xB Series	
P5020B	9 kHz to 4.5 GHz, 4 or 6-port
P5021B	9 kHz to 6.5 GHz, 4 or 6-port
P5022B	9 kHz to 9 GHz, 4 or 6-port
P5023B	9 kHz to 14 GHz, 4 or 6-port
P5024B	9 kHz to 20 GHz, 4 or 6-port
P5025B	100 kHz to 26.5 GHz, 4-port
P5026B	100 kHz to 32 GHz, 4-port
P5027B	100 kHz to 44 GHz, 4-port
P5028B	100 kHz to 53 GHz, 4-port

## Table of Contents

Keysight Streamline Series VNA.....	2
Definitions.....	5
Dynamic Range.....	6
Corrected System Performance.....	8
Uncorrected System Performance.....	17
Test Port Output.....	21
Test Port Input.....	26
Dynamic Accuracy.....	32
Spectrum Analysis (with S97090xB).....	34
Pulsed-RF Measurements (with S97025xB).....	43
Enhanced Time Domain Analysis with TDR (S97011B).....	49
Multi-instrument Measurements with S97551B Software.....	51
Multi-site Operation.....	57
General Information.....	58
Measurement Throughput Summary.....	62
Test Set Block Diagrams.....	65
Literature Information.....	67
Web Resources.....	67

## Definitions

### Specifications (spec)<sup>1</sup>

Warranted performance. Specifications include guardbands to account for the expected statistical performance distribution, measurement uncertainties, and changes in performance due to environmental conditions. All specifications and characteristics apply over a  $25\text{ °C} \pm 5\text{ °C}$  range (unless otherwise stated).

The following conditions must be met:

- Instrument has been turned on for 60 minutes with VNA application running.
- Instrument is within its calibration cycle.
- Instrument remains at a stable surrounding environment temperature (between  $-10\text{ °C}$  to  $55\text{ °C}$ ) for 60 minutes prior to turn-on.

### Characteristics (char.)

A performance parameter that the product is expected to meet before it leaves the factory, but that is not verified in the field and is not covered by the product warranty. A characteristic includes the same guardbands as a specification.

### Typical (typ.)

Expected performance of an average unit at a stable temperature between  $25\text{ °C} \pm 5\text{ °C}$  for 60 minutes prior to turn-on and during operation; does not include guardbands. It is not covered by the product warranty. The instrument must be within its calibration cycle.

### Nominal (nom.)

A general, descriptive term or design parameter. It is not tested, and not covered by the product warranty.

### Supplemental Information

A performance parameter that is tested on sampled product during design validation. It does not include guardbands and is not covered by the product warranty.

### Calibration

The process of measuring known standards to characterize an instrument's systematic (repeatable) errors.

### Corrected (residual)

Indicates performance after error correction (calibration). It is determined by the quality of calibration standards and how well "known" they are, plus system repeatability, stability, and noise.

### Uncorrected (raw)

Indicates instrument performance without error correction. The uncorrected performance affects the stability of a calibration.

1. For all tables in this data sheet, the specified performance at the exact frequency of a break is the better value of the two specifications at that frequency.

## Dynamic Range

The specifications in this section apply to measurements made with the Keysight P937xB, P938xB, P500xB, and P502xB Streamline Series vector network analyzer under the following conditions:

- No averaging applied to data

**Table 1. System dynamic range at test port (dB)<sup>1</sup>**

P9370B to P9374B, P9382B, P9384B

Description	Specification	Typical
9 kHz to 100 kHz	84	94
100 kHz to 10 MHz	108	117
10 MHz to 50 MHz <sup>2</sup>	111	120
50 MHz to 3 GHz	115	124
3 GHz to 6.5 GHz	115	122
6.5 GHz to 9 GHz	112	120
9 GHz to 14 GHz	111	120
14 GHz to 16 GHz	108	118
16 GHz to 20 GHz	105	115

P9375B, P9377B

Description	Specification	Typical
100 kHz to 300 kHz	93	106
300 kHz to 1 MHz	102	115
1 MHz to 50 MHz <sup>2</sup>	112	120
50 MHz to 3 GHz	115	124
3 GHz to 6.5 GHz	115	122
6.5 GHz to 17 GHz	112	120
17 GHz to 20 GHz	110	119
20 GHz to 24 GHz	108	119
24 GHz to 30 GHz	108	117
30 GHz to 38 GHz	102	115
38 GHz to 44 GHz	102	112

P5000B to P5004B, P5020B to P5024B

Description	Specification	Typical
9 kHz to 100 kHz	101	111
100 kHz to 300 kHz	117	126
300 kHz to 1 MHz	125	136
1 MHz to 10 MHz	130	141
10 MHz to 50 MHz <sup>2</sup>	137	147
50 MHz to 3 GHz	140	150
3 GHz to 5 GHz	140	149
5 GHz to 6.5 GHz	140	148
6.5 GHz to 9 GHz	136	146
9 GHz to 14 GHz	133	142
14 GHz to 16 GHz	130	140
16 GHz to 20 GHz	126	137

P5005B to P5008B, P5025B to P5028B

Description	Specification	Typical
100 kHz to 300 kHz	95	106
300 kHz to 500 kHz	104	120
500 kHz to 1 MHz	117	130
1 MHz to 10 MHz	125	138
10 MHz to 50 MHz <sup>2</sup>	137	147
50 MHz to 6.5 GHz	140	150
6.5 GHz to 8 GHz	138	150
8 GHz to 9 GHz	138	147
9 GHz to 16 GHz	137	147
16 GHz to 17 GHz	137	143
17 GHz to 20 GHz	132	143
20 GHz to 24 GHz	130	143
24 GHz to 25 GHz	130	141
25 GHz to 26 GHz	127	141
26 GHz to 30 GHz	127	137
30 GHz to 35 GHz	122	137
35 GHz to 40 GHz	122	134
40 GHz to 45 GHz	122	132
45 GHz to 50 GHz	100	115
50 GHz to 53 GHz	72	101

1. System dynamic range = source maximum output power minus receiver noise floor at 10 Hz IF bandwidth. Does not include crosstalk effects.
2. It may typically be degraded at 25 MHz.



## Corrected System Performance

This section provides specifications for the corrected performance of Streamline Series VNA using either of Mechanical Calibration Kit or Electronic Calibration (ECal) Module. To determine transmission and reflection uncertainty curves with other calibration kits, please download Uncertainty Calculator from [http://www.keysight.com/find/na\\_calculator](http://www.keysight.com/find/na_calculator) to generate the curves for your specific calibration kit.

Measured with 10 Hz IF bandwidth, no averaging applied to data, environmental temperature = 23 °C ( $\pm 3$  °C) with  $< 1$  °C deviation from calibration temperature.

**Table 2. P9370B to P9374B, P9382B, P9384B with 85052D economy mechanical calibration kit**

Corrected error terms (dB) – specifications

Description	9 kHz to 50 MHz	50 MHz to 2 GHz	2 GHz to 8 GHz	8 GHz to 20 GHz
Directivity	42	42	38	36
Source match	37	37	31	28
Load match	42	42	38	36
Reflection tracking	$\pm 0.003$	$\pm 0.003$	$\pm 0.004$	$\pm 0.008$
Transmission tracking	$\pm 0.136$	$\pm 0.030$	$\pm 0.100$	$\pm 0.185$

Transmission uncertainty (magnitude and phase)

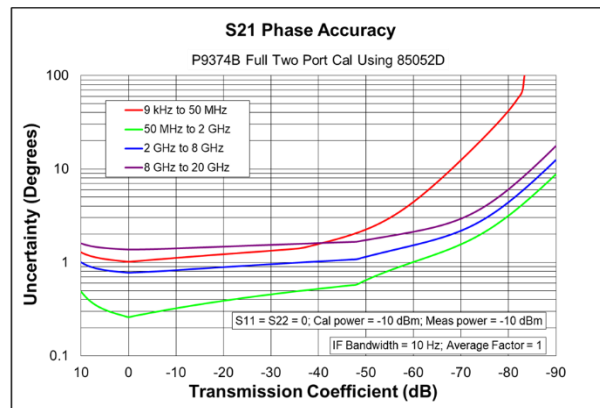
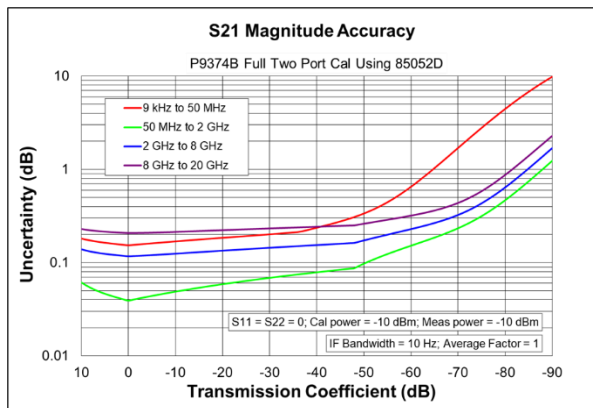



## Reflection uncertainty (magnitude and phase)

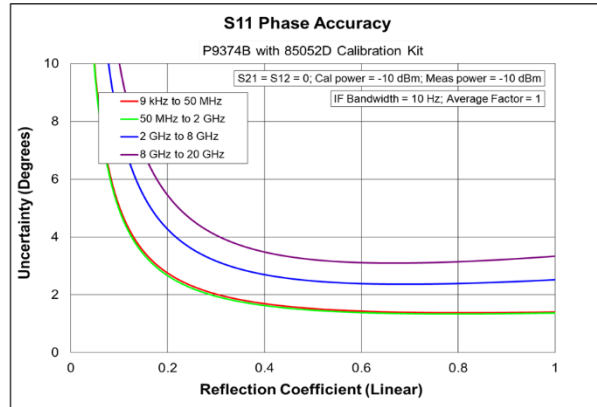
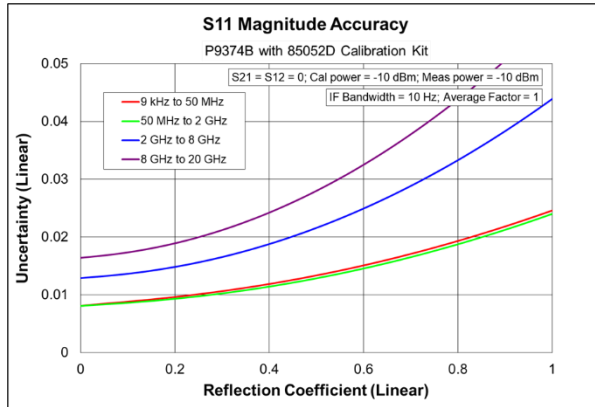
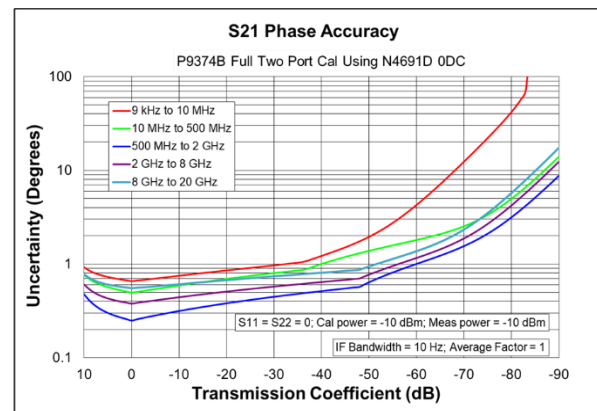
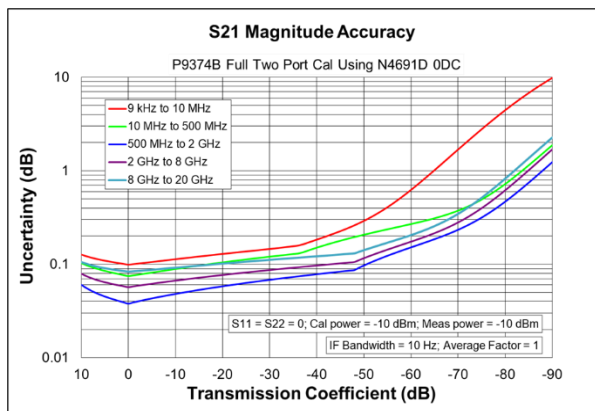

Table 3. P9370B to P9374B, P9382B, P9384B with N4691D electronic calibration (ECal) module with Option 0DC

## Corrected Error Terms (dB) – specifications

Description	9 kHz to 10 MHz	10 MHz to 500 MHz	500 MHz to 2 GHz	2 GHz to 8 GHz	8 GHz to 20 GHz
Directivity	46	46	47	46	43
Source match	41	41	47	45	42
Load match	38	40	46	44	40
Reflection tracking	± 0.050	± 0.050	± 0.020	± 0.030	± 0.040
Transmission tracking	± 0.081	± 0.056	± 0.026	± 0.042	± 0.064

## Transmission uncertainty (magnitude and phase)



## Reflection uncertainty (magnitude and phase)

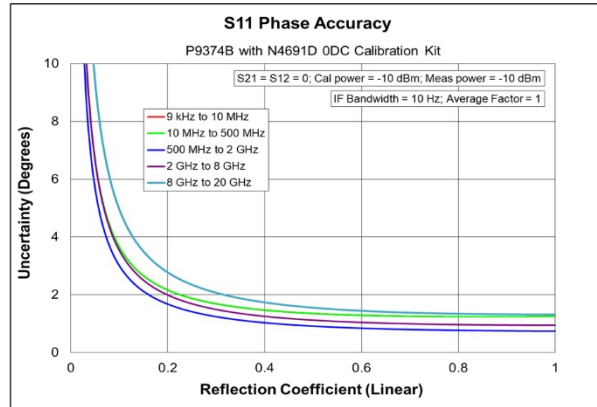
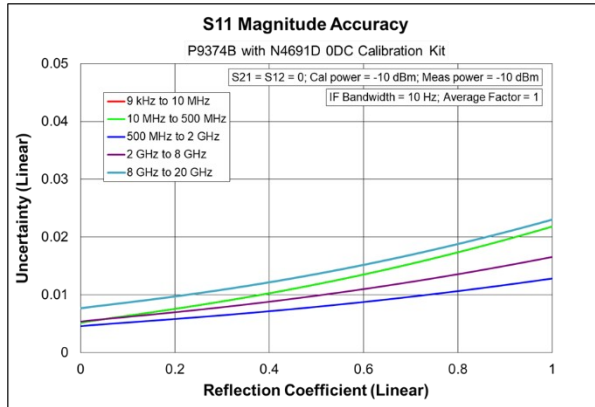
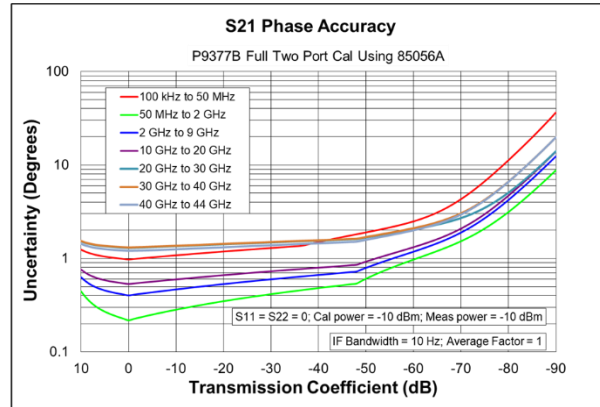
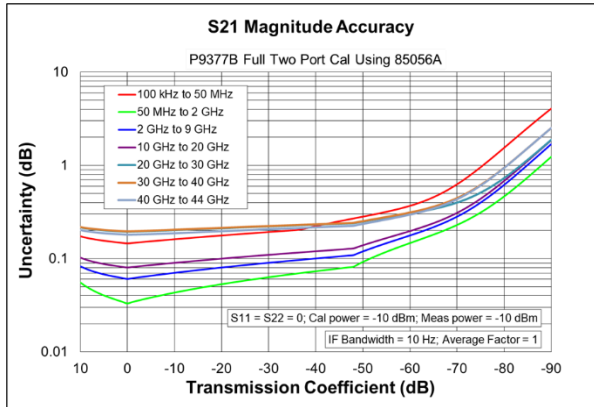

**Table 4. P9377B with 85056A mechanical calibration kit**

Corrected error terms (dB) – specifications

Description	100 kHz to 50 MHz	50 MHz to 2 GHz	2 GHz to 10 GHz	10 GHz to 20 GHz	20 GHz to 30 GHz	30 GHz to 40 GHz	40 GHz to 44 GHz
Directivity	42	42	42	42	38	38	36
Source match	41	41	38	38	33	33	31
Load match	42	42	42	42	37	37	37
Reflection tracking	± 0.001	± 0.001	± 0.008	± 0.008	± 0.020	± 0.020	± 0.027
Transmission tracking	± 0.128	± 0.020	± 0.045	± 0.065	± 0.123	± 0.175	± 0.155

## Transmission uncertainty (magnitude and phase)



## Reflection uncertainty (magnitude and phase)

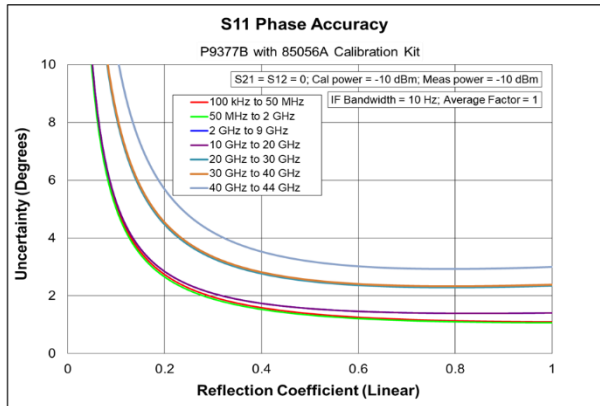
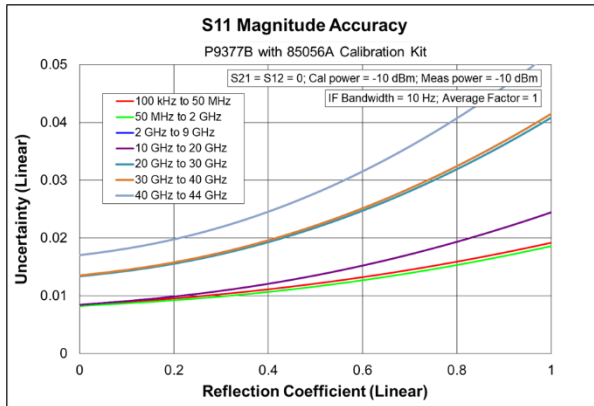
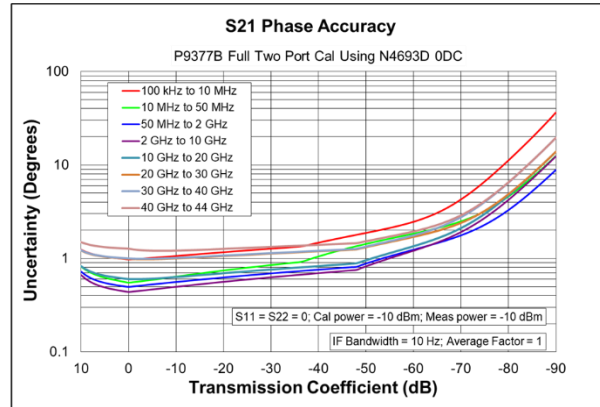
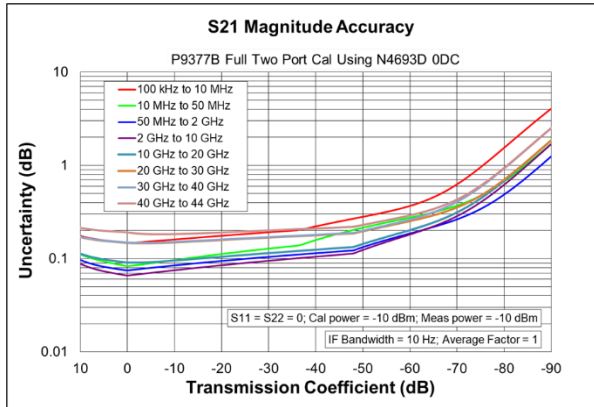

**Table 5. P9377B with N4693D electronic calibration (ECal) module with Option 0DC**

Corrected error terms (dB) – specifications

Description	100 kHz to 10 MHz	10 MHz to 50 MHz	50 MHz to 2 GHz	2 GHz to 10 GHz	10 GHz to 20 GHz	20 GHz to 30 GHz	30 GHz to 40 GHz	40 GHz to 44 GHz
Directivity	40	40	40	47	44	38	38	34
Source match	38	38	44	42	37	35	35	32
Load match	35	37	43	41	36	33	33	31
Reflection tracking	± 0.050	± 0.050	± 0.050	± 0.040	± 0.050	± 0.060	± 0.060	± 0.080
Transmission tracking	± 0.127	± 0.062	± 0.062	± 0.050	± 0.069	± 0.121	± 0.121	± 0.148

## Transmission uncertainty (magnitude and phase)



## Reflection uncertainty (magnitude and phase)

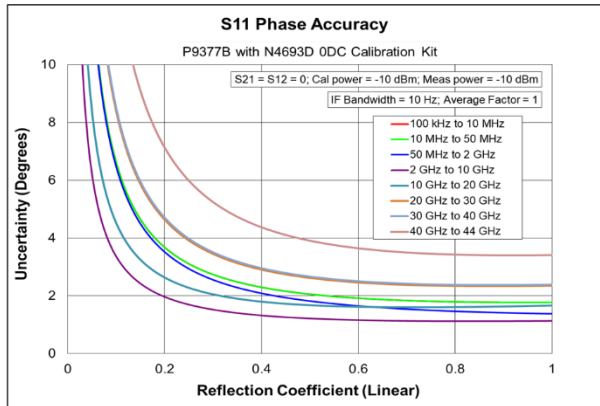
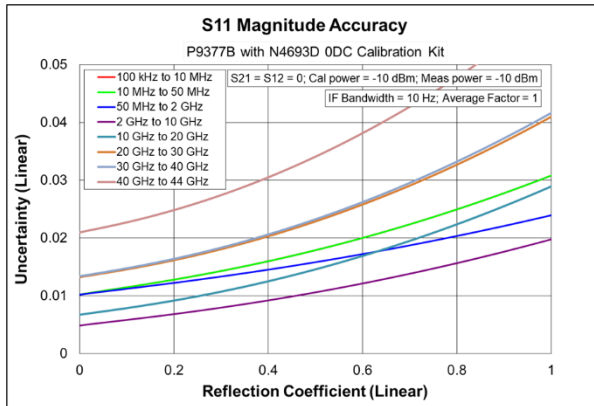

**Table 6. P5000B to P5004B, P5020B to P5024B with 85032F standard mechanical calibration kit**  
 Corrected error terms (dB) – specifications

Description	9 kHz to 50 MHz	50 MHz to 3 GHz	3 GHz to 6 GHz	6 GHz to 9 GHz
Directivity	49	46	40	38
Source match	41	40	36	35
Load match	47	46	40	38
Reflection tracking	± 0.011	± 0.021	± 0.032	± 0.054
Transmission tracking	± 0.082	± 0.021	± 0.063	± 0.074

## Transmission uncertainty (magnitude and phase)

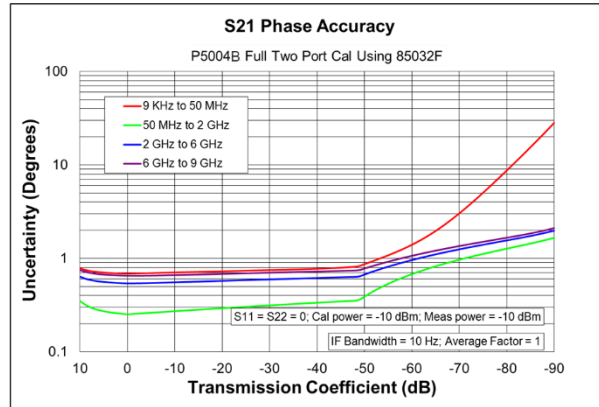
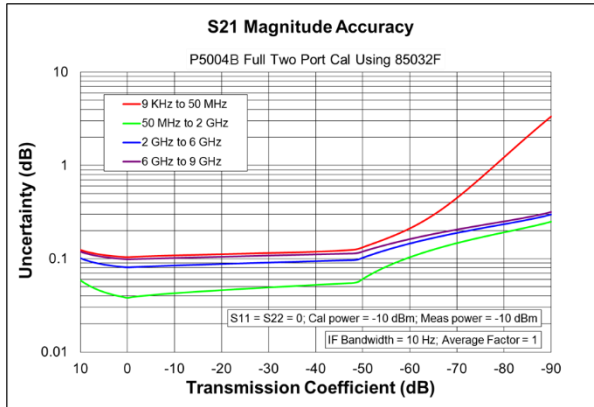

## Reflection uncertainty (magnitude and phase)

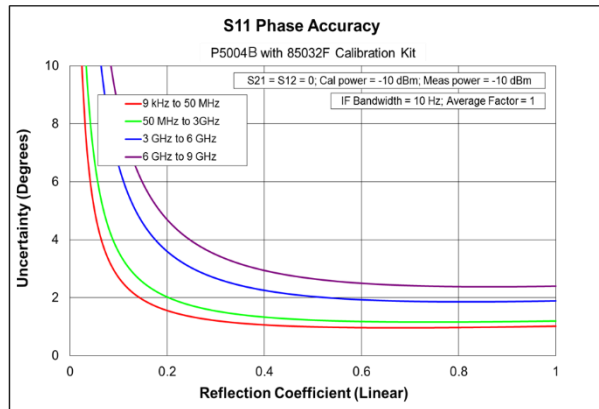
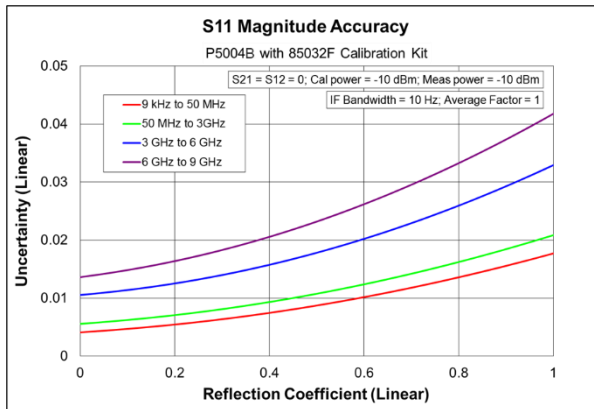
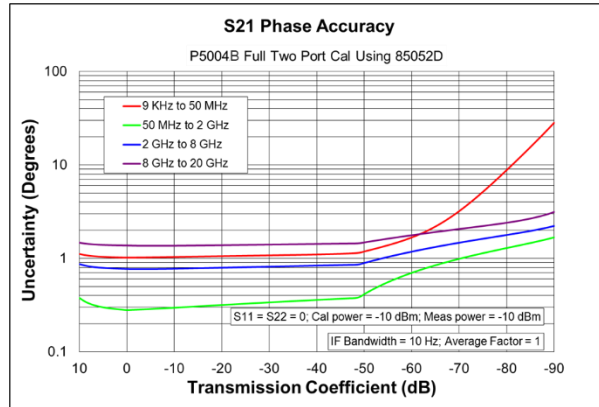
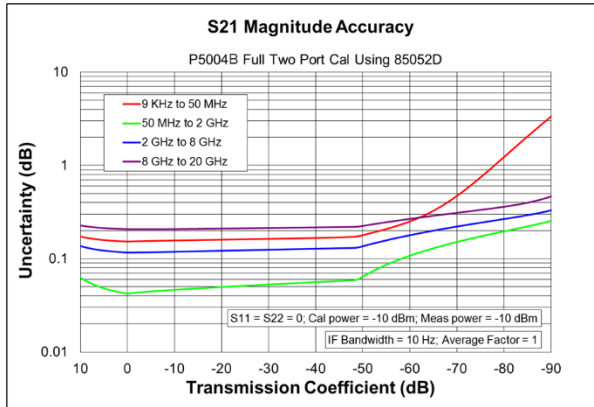

Table 7. P5000B to P5004B, P5020B to P5024B with 85052D economy mechanical calibration kit

Corrected error terms (dB) – specifications

Description	9 kHz to 50 MHz	50 MHz to 2 GHz	2 GHz to 8 GHz	8 GHz to 20 GHz
Directivity	42	42	38	36
Source match	37	37	31	28
Load match	42	42	38	36
Reflection tracking	± 0.003	± 0.003	± 0.004	± 0.008
Transmission tracking	± 0.136	± 0.03	± 0.1	± 0.185

## Transmission uncertainty (magnitude and phase)



## Reflection uncertainty (magnitude and phase)

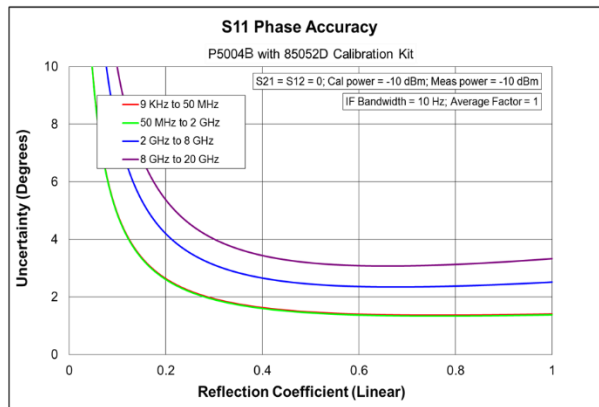
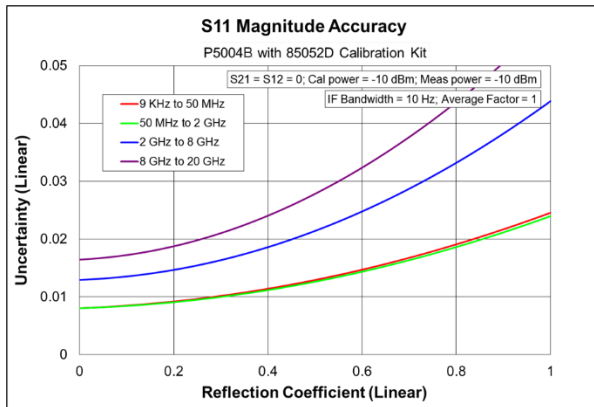
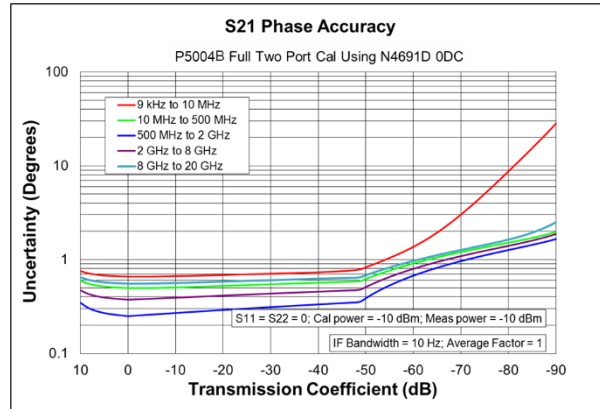
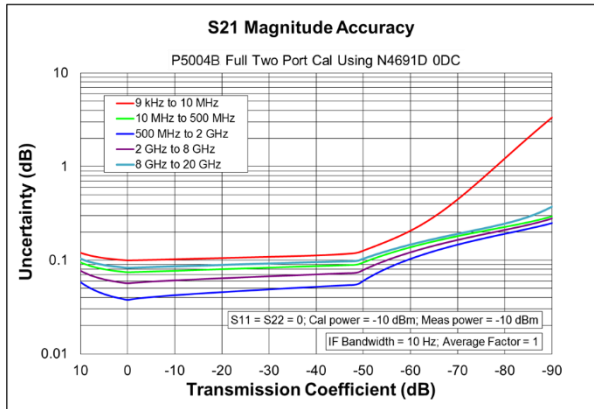

**Table 8. P5000B to P5004B, P5020B to P5024B with N4691D electronic calibration (ECal) module with Option 0DC**

Corrected error terms (dB) – specifications

Description	9 kHz to 10 MHz	10 MHz to 500 MHz	500 MHz to 2 GHz	2 GHz to 8 GHz	8 GHz to 20 GHz
Directivity	46	46	47	46	43
Source match	41	41	47	45	42
Load match	38	40	46	44	40
Reflection tracking	± 0.05	± 0.05	± 0.02	± 0.03	± 0.04
Transmission tracking	± 0.081	± 0.056	± 0.026	± 0.042	± 0.064

## Transmission uncertainty (magnitude and phase)



## Reflection uncertainty (magnitude and phase)

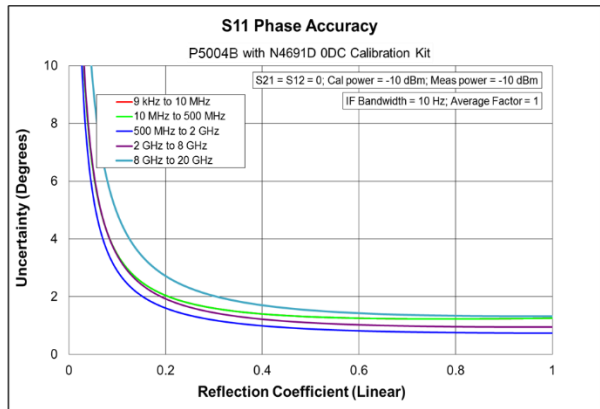
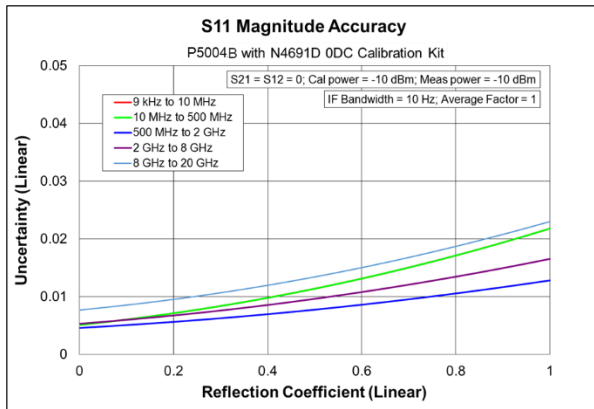

**Table 9. P5005B to P5008B, P5025B to P5028B with 85058B standard mechanical calibration kit**

Corrected error terms (dB) – specifications

Description	100 kHz to 1 MHz	1 MHz to 50 MHz	50 MHz to 2 GHz	2 GHz to 10 GHz	10 GHz to 20 GHz	20 GHz to 35 GHz	35 GHz to 50 GHz	50 GHz to 53 GHz
Directivity	35	35	35	41	38	37	37	34
Source match	34	34	34	44	40	41	42	40
Load match	34	35	35	41	37	36	36	33
Reflection tracking	± 0.019	± 0.019	± 0.019	± 0.01	± 0.033	± 0.033	± 0.02	± 0.03
Transmission tracking	± 0.302	± 0.065	± 0.046	± 0.033	± 0.073	± 0.122	± 0.079	± 0.154



## Transmission uncertainty (magnitude and phase)

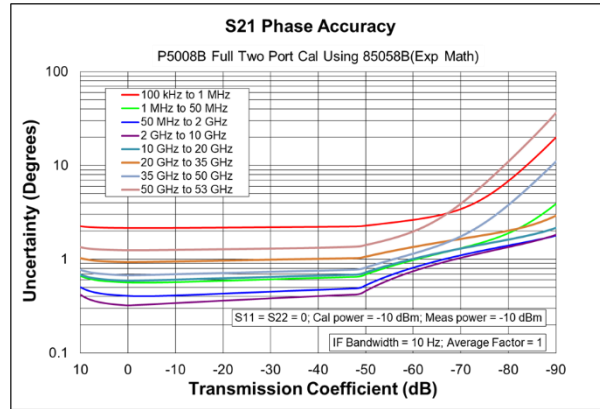
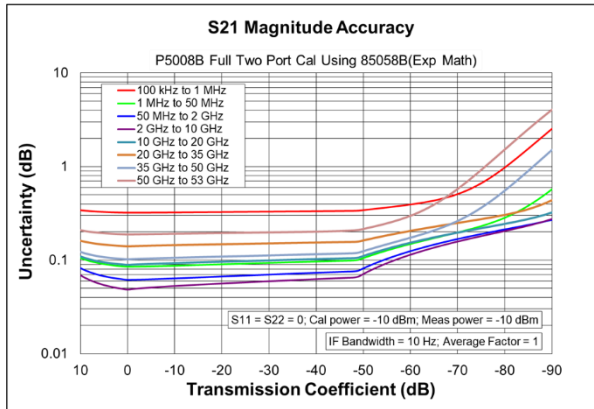

## Reflection uncertainty (magnitude and phase)

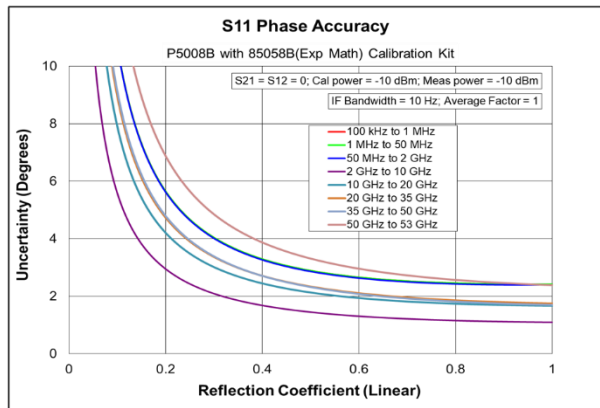
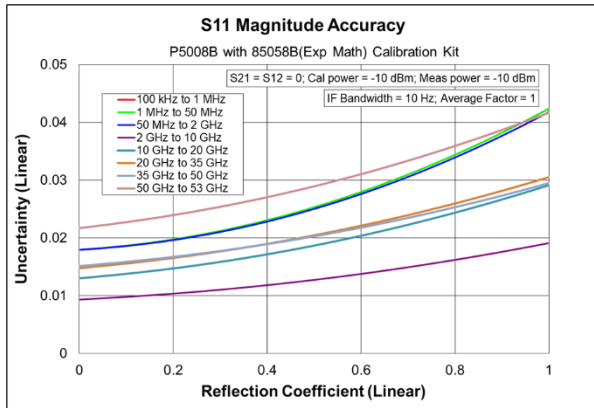
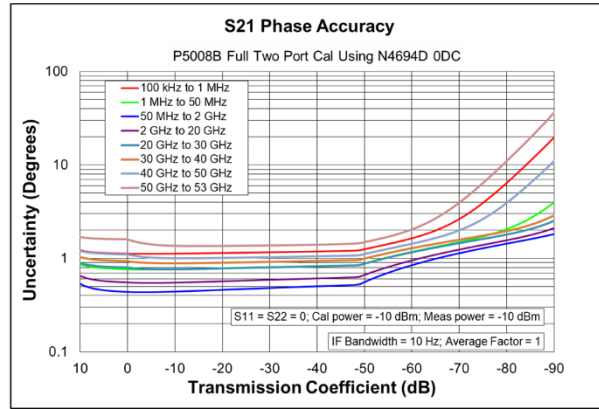
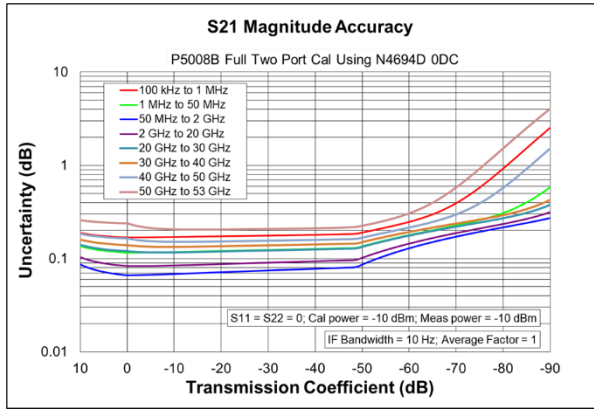

Table 10. P5005B to P5008B, P5025B to P5028B with N4694D electronic calibration (ECal) module with Option 0DC

Corrected error terms (dB) – specifications

Description	100 kHz to 1 MHz	1 MHz to 50 MHz	50 MHz to 2 GHz	2 GHz to 20 GHz	20 GHz to 30 GHz	30 GHz to 40 GHz	40 GHz to 50 GHz	50 GHz to 53 GHz
Directivity	41	41	41	42	41	40	38	35
Source match	38	38	38	39	35	34	33	30
Load match	34	37	38	38	34	32	32	29
Reflection tracking	± 0.08	± 0.08	± 0.04	± 0.04	± 0.05	± 0.06	± 0.08	± 0.08
Transmission tracking	± 0.148	± 0.095	± 0.051	± 0.065	± 0.093	± 0.108	± 0.123	± 0.166

## Transmission uncertainty (magnitude and phase)



## Reflection uncertainty (magnitude and phase)

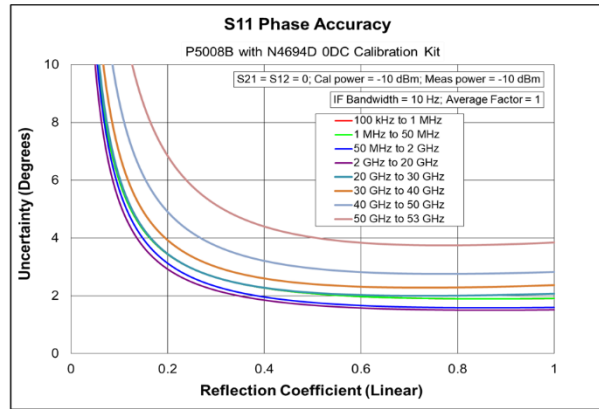
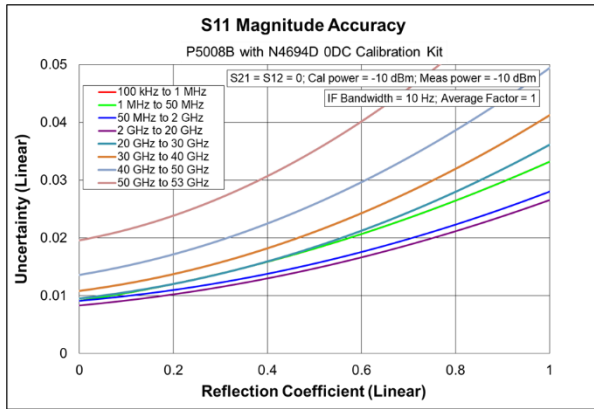

## Uncorrected System Performance

**Table 11. Uncorrected error terms (dB) – specification<sup>1</sup>**

P9370B to P9374B, P9382B, P9384B, P5000B to P5004B, P5020B to P5024B

Description	Directivity	Source match	Load match	Transmission tracking	Reflection tracking	Crosstalk
300 kHz to 10 MHz	20	20	15	-	-	-
10 MHz to 1.5 GHz	25	25	17	-	-	-
1.5 GHz to 3 GHz	25	25	16	-	-	-
3 GHz to 6 GHz	25	25	11	-	-	-
6 GHz to 10 GHz	20	20	11	-	-	-
10 GHz to 16 GHz	15	15	11	-	-	-
16 GHz to 20 GHz	15	15	8	-	-	-

P9375B, P9377B, P5005B to P5008B, P5025B to P5028B

Description	Directivity	Source match	Load match	Transmission tracking	Reflection tracking	Crosstalk
300 kHz to 1 MHz	20	20	1	-	-	-
1 MHz to 3 MHz	20	20	14	-	-	-
3 MHz to 10 MHz	20	20	17	-	-	-
10 MHz to 4 GHz	25	25	17	-	-	-
4 GHz to 6 GHz	25	25	12	-	-	-
6 GHz to 10 GHz	20	20	12	-	-	-
10 GHz to 20 GHz	15	15	9	-	-	-
20 GHz to 27 GHz	15	15	8	-	-	-
27 GHz to 40 GHz	15	15	5	-	-	-
40 GHz to 50 GHz	15	15	8	-	-	-
50 GHz to 53 GHz	10	10	5	-	-	-

1. The specifications apply to following conditions: Factory correction is turned on. Cable loss not included in transmission tracking.

**Table 12. Uncorrected error terms (dB) – typical**

P9370B to P9374B, P9382B, P9384B

Description	Directivity	Source match	Load match	Transmission tracking	Reflection tracking	Crosstalk
9 kHz to 30 kHz	40	40	5	± 0.5	± 0.5	-94
30 kHz to 100 kHz	40	40	10	± 0.5	± 0.5	-94
100 kHz to 300 kHz	40	40	18	± 0.2	± 0.2	-117
300 kHz to 3 MHz	40	40	23	± 0.2	± 0.2	-117
3 MHz to 10 MHz	40	40	23	± 0.2	± 0.2	-117
10 MHz to 50 MHz	40	40	23	± 0.2	± 0.2	-114 <sup>1</sup>
50 MHz to 1.5 GHz	40	40	23	± 0.2	± 0.2	-124
1.5 GHz to 3 GHz	40	40	20	± 0.2	± 0.2	-124
3 GHz to 4.5 GHz	40	40	15	± 0.2	± 0.2	-123
4.5 GHz to 6 GHz	40	40	15	± 0.2	± 0.2	-122
6 GHz to 9 GHz	35	35	15	± 0.3	± 0.3	-122
9 GHz to 10 GHz	35	35	15	± 0.3	± 0.3	-112
10 GHz to 13 GHz	35	35	15	± 0.5	± 0.5	-112
13 GHz to 16 GHz	35	35	15	± 0.5	± 0.5	-112
16 GHz to 20 GHz	35	35	12	± 0.5	± 0.5	-112

P9375B, P9377B

Description	Directivity	Source match	Load match	Transmission tracking	Reflection tracking	Crosstalk
100 kHz to 300 kHz	40	40	2	± 0.5	± 0.5	-86
300 kHz to 500 kHz	40	40	2	± 0.5	± 0.5	-105
500 kHz to 1 MHz	40	40	2	± 0.5	± 0.5	-110
1 MHz to 3 MHz	40	40	16	± 0.5	± 0.5	-120
3 MHz to 10 MHz	40	40	20	± 0.5	± 0.5	-120
10 MHz to 50 MHz	40	40	20	± 0.2	± 0.2	-113 <sup>1</sup>
50 MHz to 3 GHz	40	40	20	± 0.2	± 0.2	-124
3 GHz to 4 GHz	40	40	20	± 0.2	± 0.2	-122
4 GHz to 6 GHz	40	40	15	± 0.2	± 0.2	-122
6 GHz to 8 GHz	35	35	15	± 0.2	± 0.2	-120
8 GHz to 10 GHz	35	35	15	± 0.2	± 0.2	-120
10 GHz to 16 GHz	35	35	11	± 0.3	± 0.3	-120
16 GHz to 20 GHz	35	35	11	± 0.3	± 0.3	-119
20 GHz to 24 GHz	25	25	10	± 0.3	± 0.3	-119
24 GHz to 26 GHz	25	25	10	± 0.3	± 0.3	-117
26 GHz to 27 GHz	25	25	10	± 0.3	± 0.3	-117
27 GHz to 35 GHz	25	25	7	± 0.3	± 0.3	-115
35 GHz to 40 GHz	25	25	7	± 0.3	± 0.3	-112
40 GHz to 44 GHz	20	20	11	± 0.5	± 0.5	-112

P5000B to P5004B, P5020B to P5024B

Description	Directivity	Source match	Load match	Transmission tracking	Reflection tracking	Crosstalk
9 kHz to 30 kHz	40	40	5	± 0.5	± 0.5	-110
30 kHz to 100 kHz	40	40	10	± 0.5	± 0.5	-110
100 kHz to 300 kHz	40	40	18	± 0.2	± 0.2	-120
300 kHz to 3 MHz	40	40	23	± 0.2	± 0.2	-120
3 MHz to 10 MHz	40	40	23	± 0.2	± 0.2	-139
10 MHz to 50 MHz	40	40	23	± 0.2	± 0.2	-147 <sup>1</sup>
50 MHz to 1.5 GHz	40	40	23	± 0.2	± 0.2	-150
1.5 GHz to 3 GHz	40	40	20	± 0.2	± 0.2	-150
3 GHz to 4.5 GHz	40	40	15	± 0.2	± 0.2	-149
4.5 GHz to 6 GHz	40	40	15	± 0.2	± 0.2	-147
6 GHz to 9 GHz	35	35	15	± 0.3	± 0.3	-146
9 GHz to 10 GHz	35	35	15	± 0.3	± 0.3	-142
10 GHz to 13 GHz	35	35	15	± 0.5	± 0.5	-142
13 GHz to 16 GHz	35	35	15	± 0.5	± 0.5	-140
16 GHz to 20 GHz	35	35	12	± 0.5	± 0.5	-137

P5005B to P5008B, P5025B to P5028B

Description	Directivity	Source match	Load match	Transmission tracking	Reflection tracking	Crosstalk
100 kHz to 300 kHz	40	40	2	± 0.5	± 0.5	-106
300 kHz to 500 kHz	40	40	2	± 0.5	± 0.5	-120
500 kHz to 1 MHz	40	40	2	± 0.5	± 0.5	-130
1 MHz to 3 MHz	40	40	16	± 0.5	± 0.5	-130
3 MHz to 10 MHz	40	40	20	± 0.5	± 0.5	-138
10 MHz to 50 MHz	40	40	20	± 0.2	±0.2	-147 <sup>1</sup>
50 MHz to 4 GHz	40	40	20	± 0.2	± 0.2	-150
4 GHz to 6 GHz	40	40	15	± 0.2	± 0.2	-150
6 GHz to 8 GHz	35	35	15	± 0.2	± 0.2	-150
8 GHz to 10 GHz	35	35	15	± 0.2	± 0.2	-147
10 GHz to 16 GHz	35	35	11	± 0.3	± 0.3	-147
16 GHz to 20 GHz	35	35	11	± 0.3	± 0.3	-143
20 GHz to 24 GHz	25	25	10	± 0.3	± 0.3	-143
24 GHz to 26 GHz	25	25	10	± 0.3	±0.3	-141
26 GHz to 27 GHz	25	25	10	± 0.3	± 0.3	-137
27 GHz to 35 GHz	25	25	7	± 0.3	± 0.3	-137
35 GHz to 40 GHz	25	25	7	± 0.3	± 0.3	-134
40 GHz to 45 GHz	20	20	11	± 0.5	± 0.5	-132
45 GHz to 50 GHz	20	20	11	± 0.5	± 0.5	-115
50 GHz to 53 GHz	15	15	8	± 1	± 1	-101

1. It may typically be degraded at 25 MHz.

## Test Port Output<sup>1</sup>

**Table 13. Frequency resolution, accuracy, stability**

All models

Description	Specification	Typical
Frequency resolution	1 Hz	-
Frequency accuracy	$\pm 7$ ppm ( $25 \pm 5$ °C)	-
Frequency stability	-	$\pm 7$ ppm <sup>2</sup>
	-	$\pm 3$ ppm/year maximum <sup>3</sup>

1. The specifications do not apply to parallel measurements of multiple devices under test (DUT).

2. 0 to 50 °C. Assumes no variation in time.

3. Assumes no variation in temperature.

**Table 14. Maximum output port power (dBm)**

P9370B to P9374B, P9382B, P9384B

Description	Specification	Typical
9 kHz to 100 kHz	0	+2
100 kHz to 10 MHz	+5	+7
10 MHz to 4.5 GHz	+8	+10
4.5 GHz to 6.5 GHz	+8	+10
6.5 GHz to 9 GHz	+8	+10
9 GHz to 16 GHz	+7	+10
16 GHz to 20 GHz	+4	+7

P9375B, P9377B

Description	Specification	Typical
100 kHz to 300 kHz	-2	+1
300 kHz to 1 MHz	+7	+10
1 MHz to 17 GHz	+8	+10
17 GHz to 20 GHz	+7	+10
20 GHz to 24 GHz	+5	+10
24 GHz to 30 GHz	+5	+8
30 GHz to 38 GHz	+2	+8
38 GHz to 44 GHz	+2	+5

P5000B to P5004B, P5020B to P5024B

Description	Specification	Typical
9 kHz to 100 kHz	0	+2
100 kHz to 10 MHz	+5	+7
10 MHz to 4.5 GHz	+10	+13
4.5 GHz to 6.5 GHz	+10	+12
6.5 GHz to 9 GHz	+9	+12
9 GHz to 16 GHz	+7	+10
16 GHz to 20 GHz	+4	+7

P5005B to P5008B, P5025B to P5028B

Description	Specification	Typical
100 kHz to 300 kHz	-2	+1
300 kHz to 1 MHz	+7	+10
1 MHz to 17 GHz	+10	+13
17 GHz to 20 GHz	+7	+11
20 GHz to 24 GHz	+5	+11
24 GHz to 30 GHz	+5	+8
30 GHz to 38 GHz	+2	+8
38 GHz to 45 GHz	+2	+5
45 GHz to 50 GHz	-5	0
50 GHz to 53 GHz	-23	-12

**Table 15. Power sweep range (dBm)<sup>1</sup>**

P9370B to P9374B, P9382B, P9384B

Description	Specification	Typical
9 kHz to 100 kHz	-	-60 to +2
100 kHz to 10 MHz	-	-60 to +7
10 MHz to 16 GHz	-	-60 to +10
16 GHz to 20 GHz	-	-60 to +7

P9375B, P9377B

Description	Specification	Typical
100 kHz to 300 kHz	-	-60 to +1
300 kHz to 1 MHz	-	-60 to +10
1 MHz to 20 GHz	-	-60 to +10
20 GHz to 24 GHz	-	-50 to +10
24 GHz to 38 GHz	-	-50 to +8
38 GHz to 44 GHz	-	-50 to +5

P5000B to P5004B, P5020B to P5024B

Description	Specification	Typical
9 kHz to 100 kHz	-	-60 to +2
100 kHz to 10 MHz	-	-60 to +7
10 MHz to 4.5 GHz	-	-60 to +13
4.5 GHz to 9 GHz	-	-60 to +12
9 GHz to 16 GHz	-	-60 to +10
16 GHz to 20 GHz	-	-60 to +7



P5005B to P5008B, P5025B to P5028B

Description	Specification	Typical
100 kHz to 300 kHz	-	-60 to +1
300 kHz to 1 MHz	-	-60 to +10
1 MHz to 17 GHz	-	-60 to +13
17 GHz to 20 GHz	-	-60 to +11
20 GHz to 24 GHz	-	-50 to +11
24 GHz to 38 GHz	-	-50 to +8
38 GHz to 45 GHz	-	-50 to +5
45 GHz to 50 GHz	-	-50 to 0
50 GHz to 53 GHz	-	-50 to -12

1. When set to source power below -50 dBm, spurious related to LO signal may be observed.

**Table 16. Power level accuracy (dB)**

P9370B to P9374B, P9382B, P9384B, P5000B to P5004B, P5020B to P5024B<sup>1</sup>

Description	Specification	Typical
9 kHz to 100 kHz	± 4.0	± 1.0
100 kHz to 15 GHz	± 1.5	± 0.2
15 GHz to 20 GHz	± 2.0	± 0.3

1. At nominal power of 0 dBm, stepped sweep mode.

P9375B, P9377B, P5005B to P5008B, P5025B to P5028B<sup>2</sup>

Description	Specification	Typical
100 kHz to 10 MHz	± 3.0	± 0.5
10 MHz to 15 GHz	± 1.5	± 0.2
15 GHz to 30 GHz	± 2.0	± 0.2
30 GHz to 40 GHz	± 2.5	± 0.3
40 GHz to 50 GHz	± 2.5	± 0.5
50 GHz to 53 GHz	-	± 1.0

2. At nominal power of -15 dBm, stepped sweep mode.

**Table 17. Power level linearity (dB)**

P9370B to P9374B, P9382B, P9384B, P5000B to P5004B, P5020B to P5024B<sup>1</sup>

Description	Specification <sup>2</sup>	Typical <sup>3,4</sup>
9 kHz to 10 GHz	± 0.75	± 1.0
10 GHz to 20 GHz	± 1.0	± 1.0

1. Level linearity given is relative to 0 dBm.
2. Stepped sweep mode.  $-20 \text{ dBm} \leq P \leq$  maximum specified power.
3. Stepped sweep mode.  $-60 \text{ dBm} \leq P < -20 \text{ dBm}$ .
4. Swept sweep mode.  $-60 \text{ dBm} \leq P \leq$  maximum specified power.

P9375B, P9377B, P5005B to P5008B, P5025B to P5028B<sup>1</sup>

Description	Specification <sup>2</sup>	Typical
100 kHz to 10 GHz	± 0.75	± 1.0 <sup>3, 5</sup>
10 GHz to 20 GHz	± 1.0	± 1.0 <sup>3, 5</sup>
20 GHz to 50 GHz	± 2.0	± 1.0 <sup>4, 6</sup>

1. Level linearity given is relative to -15 dBm.
2. Stepped sweep mode.  $-20 \text{ dBm} \leq P \leq$  maximum specified power.
3. Swept sweep mode.  $-60 \text{ dBm} \leq P \leq$  maximum specified power.
4. Swept sweep mode.  $-65 \text{ dBm} \leq P \leq$  maximum specified power.
5. Stepped sweep mode.  $-60 \text{ dBm} \leq P < -20 \text{ dBm}$ .
6. Stepped sweep mode.  $-50 \text{ dBm} \leq P < -20 \text{ dBm}$ .

**Table 18. 2<sup>nd</sup> and 3<sup>rd</sup> harmonics at 0 dBm (dBc)<sup>1</sup>**

P9370B to P9374B, P9382B, P9384B, P5000B to P5004B, P5020B to P5024B

Description	Specification	Typical
30 kHz to 10 MHz	-	-20
10 MHz to 20 GHz	-	-25

P9375B, P9377B, P5005B to P5008B, P5025B to P5028B

Description	Specification	Typical
300 kHz to 1 MHz	-	-20
1 MHz to 20 GHz	-	-25
20 GHz to 25 GHz	-	-17
25 GHz to 40 GHz	-	-20
40 GHz to 47 GHz	-	-15
47 GHz to 53 GHz	-	-17

1. Listed frequency is harmonic frequency; tested at power of 0 dBm.

**Table 19. Sub-harmonic at nominal power (dBc)**

P9370B to P9374B, P9382B, P9384B, P5000B to P5004B, P5020B to P5024B<sup>1</sup>

Description	Specification	Typical
9 kHz to 10 MHz	-	-50
10 MHz to 20 GHz	-	-35

1. Listed frequency is fundamental frequency; tested at power of 0 dBm.

P9375B, P9377B, P5005B to P5008B, P5025B to P5028B<sup>2</sup>

Description	Specification	Typical
100 kHz to 10 GHz	-	-50
10 GHz to 20 GHz	-	-35
20 GHz to 40 GHz	-	-30
40 GHz to 47 GHz	-	-20
47 GHz to 50 GHz	-	-10
50 GHz to 53 GHz	-	-2

2. Listed frequency if fundamental frequency; tested at power of -15 dBm.

**Table 20. Non-harmonic spurs at nominal power (dBc)**

P9370B to P9374B, P9382B, P9384B, P5000B to P5004B, P5020B to P5024B<sup>1</sup>

Description	Specification	Typical
9 kHz to 10 MHz	-	-50
10 MHz to 20 GHz	-	-45

1. Listed frequency is fundamental frequency. Includes spurious related to LO signal and frac-N.

P9375B, P9377B, P5005B to P5008B, P5025B to P5028B<sup>2</sup>

Description	Specification	Typical
100 kHz to 10 GHz	-	-50
10 GHz to 20 GHz	-	-45
20 GHz to 53 GHz	-	-35

2. Listed frequency is fundamental frequency. Includes spurious related to LO signal and frac-N.

**Table 21. Nominal power (preset power level)**

Description	Specification
P9370B to P9374B, P9382B, P9384B P5000B to P5004B, P5020B to P5024B	0 dBm
P9375B, P9377B P5005B to P5008B, P5025B to P5028B	-15 dBm

**Table 22. Power resolution, maximum/minimum settable power**

All models

Description	Specification	Typical
Settable resolution	-	0.01 dB
Maximum settable power	-	+20 dBm
Minimum settable power	-	-100 dBm

## Test Port Input

**Table 23. Test port noise floor (dBm)<sup>1</sup>**

P9370B to P9374B, P9382B, P9384B

Description	Specification	Typical
9 kHz to 100 kHz	-84	-92
100 kHz to 50 MHz <sup>2</sup>	-103	-110
50 MHz to 3 GHz	-107	-114
3 GHz to 6.5 GHz	-107	-112
6.5 GHz to 14 GHz	-104	-110
14 GHz to 20 GHz	-101	-108

P9375B, P9377B

Description	Specification	Typical
100 kHz to 1 MHz	-95	-105
1 MHz to 50 MHz <sup>2</sup>	-104	-110
50 MHz to 3 GHz	-107	-114
3 GHz to 6.5 GHz	-107	-112
6.5 GHz to 17 GHz	-104	-110
17 GHz to 30 GHz	-103	-109
30 GHz to 44 GHz	-100	-107

P5000B to P5004B, P5020B to P5024B

Description	Specification	Typical
9 kHz to 100 kHz	-101	-109
100 kHz to 300 kHz	-112	-119
300 kHz to 1 MHz	-120	-127
1 MHz to 10 MHz	-125	-132
10 MHz to 50 MHz <sup>2</sup>	-127	-134
50 MHz to 3 GHz	-130	-137
3 GHz to 4.5 GHz	-130	-136
4.5 GHz to 6.5 GHz	-130	-135
6.5 GHz to 9 GHz	-127	-134
9 GHz to 14 GHz	-126	-132
14 GHz to 16 GHz	-123	-130
16 GHz to 20 GHz	-122	-130

P5005B to P5008B, P5025B to P5028B

Description	Specification	Typical
100 kHz to 300 kHz	-97	-105
300 kHz to 500 kHz	-97	-110
500 kHz to 1 MHz	-110	-120
1 MHz to 10 MHz	-115	-124
10 MHz to 50 MHz <sup>2</sup>	-127	-133
50 MHz to 200 MHz	-130	-133
200 MHz to 3 GHz	-130	-137
3 GHz to 6.5 GHz	-130	-135
6.5 GHz to 9 GHz	-128	-134
9 GHz to 17 GHz	-127	-133
17 GHz to 25 GHz	-125	-131
25 GHz to 30 GHz	-122	-129
30 GHz to 45 GHz	-120	-127
45 GHz to 50 GHz	-105	-115
50 GHz to 53 GHz	-95	-113

1. Noise floor in a 10 Hz IF Bandwidth. Measured with 1 kHz IF bandwidth for 9 kHz to < 100 kHz, and 30 kHz IF bandwidth for 100 kHz to 53 GHz. Test port terminated.
2. It may typically be degraded at 25 MHz.

**Table 24. Receiver compression at test port**

P9370B to P9374B, P9382B, P9384B

Description	Input power at test port (dBm)	Specification		Typical	
		Magnitude (dB)	Phase (°)	Magnitude (dB)	Phase (°)
9 kHz to 100 kHz	0	0.5	5	0.10	1.5
100 kHz to 10 MHz	+5	0.2	5	0.05	1.0
10 MHz to 6.5 GHz	+8	0.2	5	0.05	1.0
6.5 GHz to 9 GHz	+8	0.2	5	0.05	1.0
9 GHz to 16 GHz	+7	0.2	5	0.05	1.0
16 GHz to 20 GHz	+4	0.2	5	0.05	1.0

P9375B, P9377B

Description	Input power at test port (dBm)	Specification		Typical	
		Magnitude (dB)	Phase (°)	Magnitude (dB)	Phase (°)
100 kHz to 300 kHz	-2	0.2	5	0.10	1.0
300 kHz to 1 MHz	+7	0.2	5	0.10	1.0
1 MHz to 17 GHz	+8	0.2	5	0.05	1.0
17 GHz to 20 GHz	+7	0.2	5	0.05	1.0
20 GHz to 30 GHz	+5	0.2	5	0.05	1.0
30 GHz to 44 GHz	+2	0.2	5	0.05	1.0

P5000B to P5004B, P5020B to P5024B

Description	Input power at test port (dBm)	Specification		Typical	
		Magnitude (dB)	Phase (°)	Magnitude (dB)	Phase (°)
9 kHz to 100 kHz	0	0.5	5	0.10	1.5
100 kHz to 10 MHz	+5	0.2	5	0.05	1.0
10 MHz to 6.5 GHz	+10	0.2	5	0.05	1.0
6.5 GHz to 9 GHz	+9	0.2	5	0.05	1.0
9 GHz to 16 GHz	+7	0.2	5	0.05	1.0
16 GHz to 20 GHz	+4	0.2	5	0.05	1.0

P5005B to P5008B, P5025B to P5028B

Description	Input power at test port (dBm)	Specification		Typical	
		Magnitude (dB)	Phase (°)	Magnitude (dB)	Phase (°)
100 kHz to 300 kHz	-2	0.2	5	0.10	1.0
300 kHz to 1 MHz	+7	0.2	5	0.10	1.0
1 MHz to 17 GHz	+10	0.2	5	0.05	1.0
17 GHz to 20 GHz	+7	0.2	5	0.05	1.0
20 GHz to 30 GHz	+5	0.2	5	0.05	1.0
30 GHz to 45 GHz	+2	0.2	5	0.05	1.0
45 GHz to 50 GHz	-5	0.2	5	0.05	1.0
50 GHz to 53 GHz	-23	0.2	5	0.05	1.0

**Table 25. Trace noise magnitude (dB rms)<sup>1</sup>**

P9370B to P9374B, P9382B, P9384B

Description	Specification	Typical
9 kHz to 30 kHz	0.005	0.0025
30 kHz to 100 kHz	0.003	0.001
100 kHz to 10 MHz	0.0021	0.0007
10 MHz to 6 GHz <sup>2</sup>	0.0015	0.0005
6 GHz to 10 GHz	0.002	0.0006
10 GHz to 20 GHz	0.003	0.001

P9375B, P9377B

Description	Specification	Typical
100 kHz to 300 kHz	0.005	0.002
300 kHz to 1 MHz	0.003	0.001
1 MHz to 4.5 GHz <sup>2</sup>	0.0018	0.0006
4.5 GHz to 10 GHz	0.0023	0.001
10 GHz to 17 GHz	0.003	0.0015
17 GHz to 30 GHz	0.0036	0.0015
30 GHz to 44 GHz	0.0072	0.0027

P5000B to P5004B, P5020B to P5024B

Description	Specification	Typical
9 kHz to 30 kHz	0.005	0.0025
30 kHz to 100 kHz	0.003	0.001
100 kHz to 6 GHz <sup>2</sup>	0.0015	0.0005
6 GHz to 10 GHz	0.002	0.0006
10 GHz to 20 GHz	0.003	0.001

P5005B to P5008B, P5025B to P5028B

Description	Specification	Typical
100 kHz to 300 kHz	0.005	0.002
300 kHz to 1 MHz	0.003	0.001
1 MHz to 4.5 GHz <sup>2</sup>	0.0015	0.0005
4.5 GHz to 10 GHz	0.0015	0.0007
10 GHz to 17 GHz	0.002	0.001
17 GHz to 30 GHz	0.003	0.0013
30 GHz to 45 GHz	0.006	0.0022
45 GHz to 50 GHz	0.018	0.006

1. Transmission and reflection trace noise in a 1 kHz IF bandwidth for < 10 MHz, 10 kHz IF bandwidth for ≥ 10 MHz. At maximum specified power.
2. It may typically be degraded at particular frequencies such as 25 MHz, 54 MHz, 58.5 MHz, 156 MHz, 108 MHz, 120 MHz or 132 MHz.

**Table 26. Trace noise phase (degree rms)<sup>1</sup>**

P9370B to P9374B, P9382B, P9384B

Description	Specification	Typical
9 kHz to 30 kHz	0.07	0.025
30 kHz to 100 kHz	0.05	0.017
100 kHz to 300 kHz	0.035	0.006
300 kHz to 6 GHz <sup>2</sup>	0.01	0.003
6 GHz to 10 GHz	0.02	0.006
10 GHz to 13.5 GHz	0.03	0.006
13.5 GHz to 20 GHz	0.03	0.01

P9375B, P9377B

Description	Specification	Typical
100 kHz to 300 kHz	0.07	0.015
300 kHz to 1 MHz	0.03	0.01
1 MHz to 6 GHz <sup>2</sup>	0.024	0.0036
6 GHz to 10 GHz	0.024	0.0048
10 GHz to 17 GHz	0.024	0.0072
17 GHz to 30 GHz	0.032	0.016
30 GHz to 44 GHz	0.048	0.022

P5000B to P5004B, P5020B to P5024B



Description	Specification	Typical
9 kHz to 30 kHz	0.07	0.025
30 kHz to 100 kHz	0.05	0.017
100 kHz to 300 kHz	0.035	0.006
300 kHz to 6 GHz <sup>2</sup>	0.01	0.003
6 GHz to 10 GHz	0.02	0.006
10 GHz to 13.5 GHz	0.03	0.006
13.5 GHz to 20 GHz	0.03	0.01

P5005B to P5008B, P5025B to P5028B

Description	Specification	Typical
100 kHz to 300 kHz	0.07	0.015
300 kHz to 1 MHz	0.03	0.01
1 MHz to 6 GHz <sup>2</sup>	0.02	0.003
6 GHz to 10 GHz	0.02	0.004
10 GHz to 17 GHz	0.02	0.006
17 GHz to 30 GHz	0.02	0.01
30 GHz to 45 GHz	0.04	0.018
45 GHz to 50 GHz	0.18	0.03

1. Transmission and reflection trace noise in a 1 kHz IF bandwidth for < 10 MHz, 10 kHz IF bandwidth for ≥ 10 MHz. At maximum specified power.
2. It may typically be degraded at particular frequencies such as 25 MHz, 54 MHz, 58.5 MHz, 156 MHz, 108 MHz, 120 MHz or 132 MHz.

**Table 27. Temperature stability – typical**

P9370B to P9374B, P9382B, P9384B, P5000B to P5004B, P5020B to P5024B

Description	Magnitude (dB/°C)	Phase (degree/°C)
9 kHz to 300 kHz	0.03	0.2
300 kHz to 4.5 GHz	0.005	0.1
4.5 GHz to 6 GHz	0.01	0.1
6 GHz to 6.5 GHz	0.01	0.2
6.5 GHz to 10 GHz	0.015	0.2
10 GHz to 14 GHz	0.015	0.3
14 GHz to 20 GHz	0.02	0.4

P9375B, P9377B, P5005B to P5008B

Description	Magnitude (dB/°C)	Phase (degree/°C)
100 kHz to 1 MHz	0.03	1.0
1 MHz to 10 MHz	0.005	0.2
10 MHz to 4.5 GHz	0.005	0.1
4.5 GHz to 10 GHz	0.01	0.1
10 GHz to 20 GHz	0.01	0.2
20 GHz to 30 GHz	0.01	0.25
30 GHz to 40 GHz	0.01	0.3
40 GHz to 50 GHz	0.03	0.8
50 GHz to 53 GHz	0.06	1.0

P5025B to P5028B

Description	Magnitude (dB/°C)	Phase (degree/°C)
100 kHz to 1 MHz	0.03	1.0
1 MHz to 10 MHz	0.005	0.2
10 MHz to 4.5 GHz	0.005	0.1
4.5 GHz to 10 GHz	0.01	0.1
10 GHz to 20 GHz	0.01	0.2
20 GHz to 30 GHz	0.01	0.4
30 GHz to 40 GHz	0.01	0.4
40 GHz to 50 GHz	0.03	0.8
50 GHz to 53 GHz	0.06	1.0

**Table 28. Damage input level**

All models

Description	
Damage Input Level	+27 dBm or ± 35 VDC (Warranted)

# Dynamic Accuracy

Accuracy of the test port input power relative to the reference input power level. Measured with 10 Hz IF bandwidth.

## Dynamic accuracy<sup>1</sup> – specification

P9370B to P9374B, P9382B, P9384B

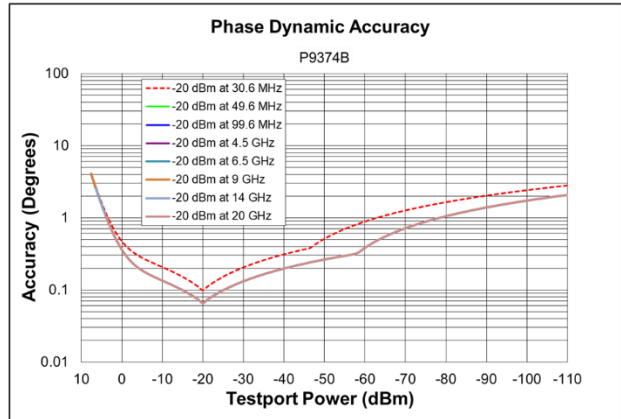
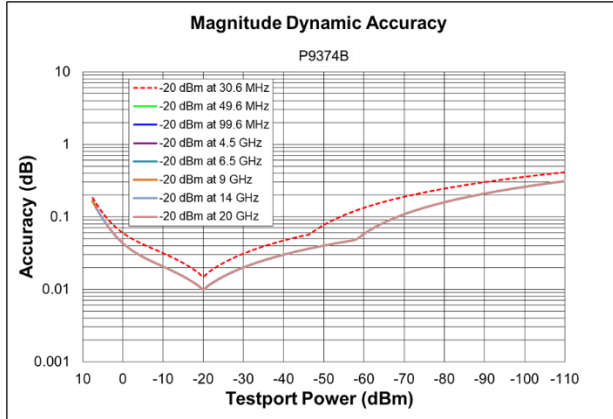

P9375B, P9377B

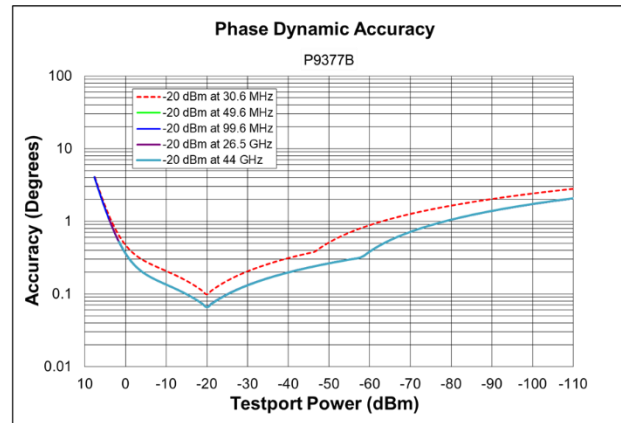
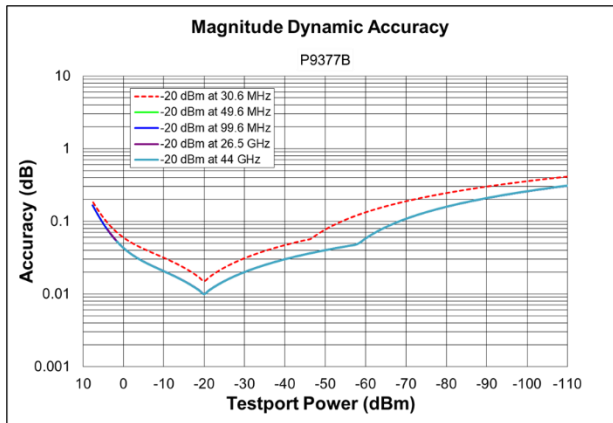

P5000B to P5004B, P5020B to P5024B

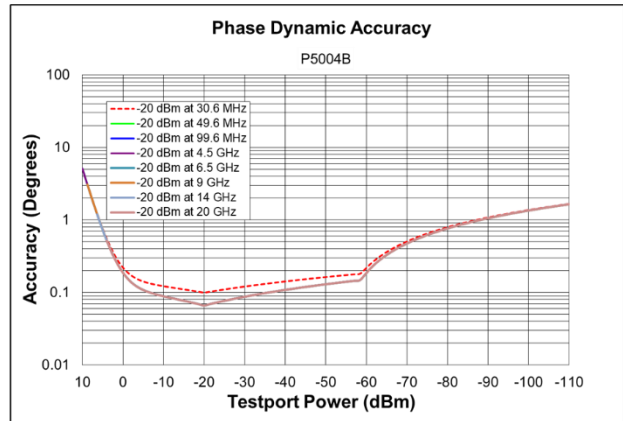
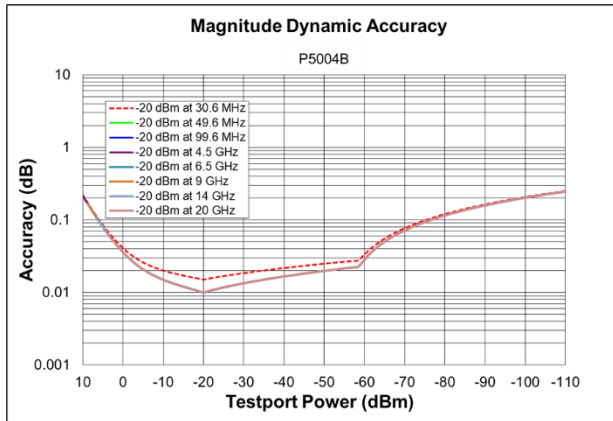

P5005B to P5008B, P5025B to P5028B

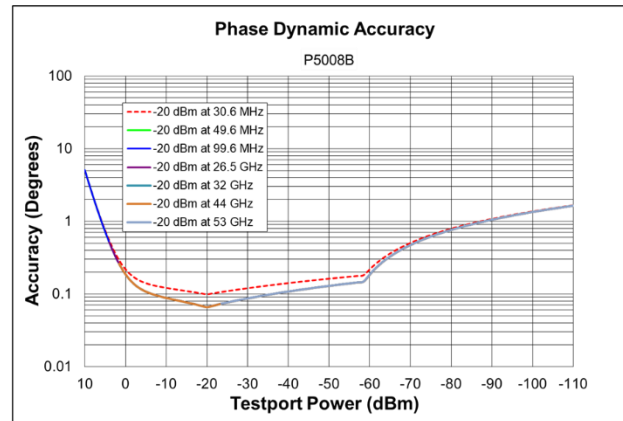
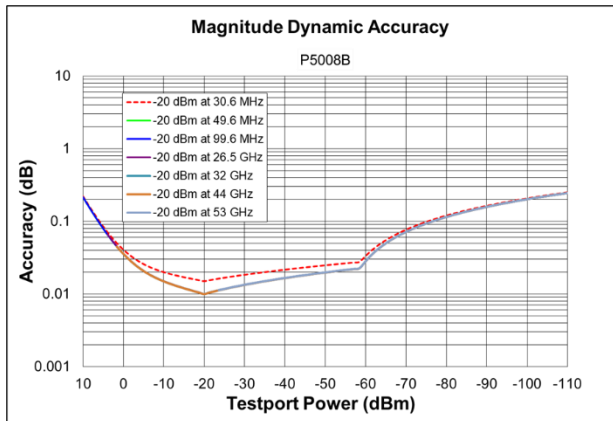

1. Dynamic accuracy is verified with the following measurements:
  - Compression over frequency.
  - IF linearity at three single frequencies (30.6 MHz, 49.6 MHz and 99.6 MHz) using a reference level of -20 dBm for an input power range of 0 to -60 dBm. For values below -60 dBm, refer to [VNA Receiver Dynamic Accuracy Specifications and Uncertainties](#).
2. Download Uncertainty Calculator from [http://www.keysight.com/find/na\\_calculator](http://www.keysight.com/find/na_calculator) to generate the curves of dynamic accuracy.

## Spectrum Analysis (with S97090xB)

This section provides specifications for the P50xxB Streamline Series VNA. The S97090xB Software is required to enable spectrum analysis functions of the P50xxB.

**Table 29. Frequency specifications**

All models

Description	Specification	Supplemental Information
<b>Frequency Reference<sup>1</sup></b>		
Accuracy	-	± [(time since last adjustment x aging rate) + temperature stability + calibration accuracy], typical
Aging Rate	-	± 3 ppm/year maximum, typical
Temperature Stability	-	± 7 ppm (0 to 50 °C)
Achievable Initial Calibration Accuracy	± 7 ppm (25 ± 5 °C)	-
Frequency Readout Accuracy (Start, Stop, Center, Marker)	-	± [(readout frequency x frequency reference accuracy) + (< 1% x RBW)], nominal
<b>Frequency Span</b>		
Minimum/Maximum	Analyzer's full span	-
Resolution	1 Hz	-
Sweep (Trace) Point Range	11 to 100,001	-
<b>Resolution Bandwidth (RBW)</b>		
Range (-3 dB Bandwidth)	10 Hz to 3 MHz in 10% steps	-
Bandwidth Range Accuracy	-	± 1%, all RBW, except below 100 MHz with 3 MHz RBW
Selectivity (-60 dB/-3 dB)	-	Gaussian: 4.5:1, Flat top: 2.47:1, Kaiser: 3.82:1, Blackman: 3.58:1
<b>Video Bandwidth (VBW)</b>		
Range	10 Hz to 3 MHz	-

1. Frequency reference accuracy can be improved by using external frequency reference with better accuracy.

**Table 30. Time specifications**

Description	Specification	Supplemental Information
<b>Sweep Time and Triggering</b>		
Sweep Time Range	Auto	-
Trigger Types	Continuous, Single, Group, Manual, External	-
Trigger Delay Range	0 to 3 s	-
Trigger Delay Resolution	1 $\mu$ s	-
<b>Measuring and Display Update Rate (milliseconds)<sup>1</sup></b>		
20 MHz Span, 3 kHz RBW, 3 kHz VBW	-	64
100 MHz Span, Auto RBW, Auto VBW	-	63
1 GHz Span, 3 kHz RBW, 3 kHz VBW	-	149
1 GHz Span, 300 kHz RBW, 300 kHz VBW	-	63
10 GHz Span, 3 kHz RBW, 3 kHz VBW	-	1461
10 GHz Span, 300 kHz RBW, 300 kHz VBW	-	319
10 MHz to 20 GHz, RBW/VBW = 1 MHz	-	570
10 MHz to 50 GHz, RBW/VBW = 1 MHz	-	1426

1. Measured with a 2-port model with firmware revision A.15.20.0x.

**Table 31. Amplitude accuracy and range specifications**

All models

Description	Specification
<b>Amplitude Range</b>	
Measurement Range	DANL to maximum input level
Input Attenuator Range	High attenuation or Low attenuation
Maximum Safe Input Level	+27 dBm
<b>Display Range</b>	
Log Scale	0.001 to 500 dB/div in 0.001 steps
Linear Scale	10 divisions (default)
Scale Units	dBm, mW
Trace Detectors Types	Average, Sample, Peak, Normal, Negative Peak, Peak sample, Peak average

**Table 32. SA Detector accuracy (dB)<sup>1</sup> – specifications**

P5000B to P5004B, P5020B to P5024B

Description	Specification (dB)
9 kHz to 10 MHz	± 0.15
10 MHz to 20 GHz	± 0.1

P5005B to P5008B, P5025B to P5028B

Description	Specification (dB)
100 kHz to 10 MHz	± 0.15
10 MHz to 20 GHz	± 0.1
20 GHz to 53 GHz	± 0.15

1. With high attenuation. SA detector accuracy is residual error of IF response calibration. IF response is characterized with P50xxB's standard measurement class after power and S-parameter calibration. Therefore, the SA total absolute amplitude accuracy includes power meter, S-parameter and SA detector accuracies. Add input attenuation switching uncertainty if receiver attenuator is changed after user calibration.

**Table 33. Input attenuation switching uncertainty (dB) – supplemental information**

P5000B to P5004B, P5020B to P5024B

Description	Supplemental Information
9 kHz to 50 MHz	± 0.5
50 MHz to 20 GHz	± 1.0

P5005B to P5008B, P5025B to P5028B

Description	Supplemental Information
100 kHz to 50 MHz	± 0.5
50 MHz to 53 GHz	± 1.0

**Table 34. Input VSWR – specifications**

P5000B to P5004B, P5020B to P5024B

Description	Specifications
300 kHz to 10 MHz	1.433
10 MHz to 1.5 GHz	1.329
1.5 GHz to 3 GHz	1.377
3 GHz to 10 GHz	1.785
10 GHz to 16 GHz	1.785
16 GHz to 20 GHz	2.323

P5005B to P5008B, P5025B to P5028B

Description	Specifications
1 MHz to 3 MHz	1.499
3 MHz to 4 GHz	1.329
4 GHz to 10 GHz	1.671
10 GHz to 20 GHz	2.100
20 GHz to 27 GHz	2.323
27 GHz to 40 GHz	3.570
40 GHz to 50 GHz	2.323
50 GHz to 53 GHz	3.570

**Table 35. Other amplitude accuracy – supplemental information**

All models

Description	Supplemental Information
RBW Switching Uncertainty	0.02 dB
Display Scale Fidelity	See dynamic accuracy specification. Specification applied to SA measurement class with user calibration between -10 dBm and -40 dBm input power and measurement between +10 dBm and -120 dBm input power.

**Table 36. Spurious response – supplemental information**

All models

Description	Supplemental Information
Image Response	Mostly eliminated. Intermittent image response may be seen when making multi-tone or modulated signal measurements.
LO Related Spurious	Eliminated

**Table 37. Displayed average noise level (DANL) at test ports with low attenuation (dBm/Hz)<sup>1</sup> – specifications**

P5000B to P5004B, P5020B to P5024B

Description	Specifications	Typical
9 kHz to 100 kHz	-114	-122
100 kHz to 300 kHz	-125	-132
300 kHz to 1 MHz	-133	-138
1 MHz to 10 MHz	-138	-145
10 MHz to 100 MHz	-140	-147
100 MHz to 4.5 GHz	-144	-150
4.5 GHz to 6.5 GHz	-144	-149
6.5 GHz to 9 GHz	-141	-148
9 GHz to 14 GHz	-140	-146
14 GHz to 16 GHz	-137	-144
16 GHz to 20 GHz	-136	-144



P5005B to P5008B, P5025B to P5028B

Description	Specifications	Typical
100 kHz to 300 kHz	-110	-118
300 kHz to 500 kHz	-110	-120
500 kHz to 1 MHz <sup>2</sup>	-123	-130
1 MHz to 10 MHz	-128	-134
10 MHz to 100 MHz	-136	-142
100 MHz to 200 MHz	-144	-146
200 MHz to 3 GHz	-144	-150
3 GHz to 6.5 GHz	-144	-148
6.5 GHz to 9 GHz	-142	-147
9 GHz to 17 GHz	-141	-146
17 GHz to 20 GHz	-139	-146
20 GHz to 25 GHz	-139	-143
25 GHz to 30 GHz	-136	-143
30 GHz to 45 GHz	-134	-141
45 GHz to 50 GHz	-119	-129
50 GHz to 53 GHz	-109	-127

1. Tested with 1 kHz RBW for 9 kHz to 50 MHz and 10 kHz RBW for above 50 MHz, test port terminated, average detector, averaging type = Log, IF gain = Auto, image rejection = normal, random LO OFF.
2. A residual spurious response may be observed around 600 kHz.

**Table 38. Displayed average noise level (DANL) at test ports with high attenuation (dBm/Hz)<sup>1</sup> – typical**

P5000B to P5004B, P5020B to P5024B

Description	Specifications	Typical
9 kHz to 100 kHz	-	-100
100 kHz to 300 kHz	-	-110
300 kHz to 10 MHz	-	-116
10 MHz to 100 MHz	-	-116
100 MHz to 4.5 GHz	-	-127
4.5 GHz to 6.5 GHz	-	-127
6.5 GHz to 9 GHz	-	-126
9 GHz to 14 GHz	-	-124
14 GHz to 16 GHz	-	-122
16 GHz to 20 GHz	-	-122

P5005B to P5008B, P5025B to P5028B

Description	Specifications	Typical
100 kHz to 300 kHz	-	-96
300 kHz to 500 kHz	-	-98
500 kHz to 1 MHz <sup>2</sup>	-	-108
1 MHz to 10 MHz	-	-112
10 MHz to 100 MHz	-	-112
100 MHz to 200 MHz	-	-124
200 MHz to 3 GHz	-	-128
3 GHz to 6.5 GHz	-	-126
6.5 GHz to 9 GHz	-	-125
9 GHz to 20 GHz	-	-124
20 GHz to 30 GHz	-	-121
30 GHz to 45 GHz	-	-119
45 GHz to 50 GHz	-	-107
50 GHz to 53 GHz	-	-105

1. Tested with 1 kHz RBW for 9 kHz to 50 MHz and 10 kHz RBW for above 50 MHz, test port terminated, average detector, averaging type = Log, IF gain = Auto, image rejection = normal, random LO OFF.
2. A residual spurious response may be observed around 600 kHz.

**Table 39. Second harmonic distortion with high attenuation<sup>1</sup> – supplemental information**

P5000B to P5004B, P5020B to P5024B

Description	SHI (dBm)
50 MHz to 1 GHz	+30
1 GHz to 4 GHz	+38
4 GHz to 10 GHz	+47

P5005B to P5008B, P5025B to P5028B

Description	SHI (dBm)
50 MHz to 1 GHz	+30
1 GHz to 4 GHz	+38
4 GHz to 10 GHz	+47
10 GHz 15 GHz	+44
15 GHz to 26.5 GHz	+40

1. Tested with 0 dBm for 50 MHz to 10 GHz, and -5 dBm for 10 GHz to 26.5 GHz input at test port, 10 MHz tone separations.

**Table 40. Second harmonic distortion with low attenuation<sup>1</sup> – supplemental information**

P5000B to P5004B, P5020B to P5024B

Description	SHI (dBm)
50 MHz to 1 GHz	+10
1 GHz to 4 GHz	+20
4 GHz to 10 GHz	+30

P5005B to P5008B, P5025B to P5028B

Description	SHI (dBm)
50 MHz to 1 GHz	+10
1 GHz to 4 GHz	+20
4 GHz to 10 GHz	+30
10 GHz to 15 GHz	+26
15 GHz to 20 GHz	+21
20 GHz to 26.5 GHz	+16

1. Tested with -25 dBm input at test port, 10 MHz tone separations.

**Table 41. Third order intermodulation distortion with high attenuation<sup>1</sup> – characteristic**

P5000B to P5004B, P5020B to P5024B

Description	Distortion (dBc)	TOI (dBm)
50 MHz to 200 MHz	-40	+20
200 MHz to 2 GHz	-44	+22
2 GHz to 5 GHz	-46	+23
5 GHz to 10 GHz	-50	+25
10 GHz to 15 GHz	-60	+25
15 GHz to 20 GHz	-54	+22

P5005B to P5008B, P5025B to P5028B

Description	Distortion (dBc)	TOI (dBm)
50 MHz to 200 MHz	-40	+20
200 MHz to 2 GHz	-44	+22
2 GHz to 5 GHz	-46	+23
5 GHz to 10 GHz	-50	+25
10 GHz to 15 GHz	-56	+23
15 GHz to 20 GHz	-52	+21
20 GHz to 30 GHz	-42	+16
30 GHz to 40 GHz	-48	+14
40 GHz to 53 GHz	-52	+11

1. Tested with 0 dBm for 50 MHz to 10 GHz, -5 dBm for 10 GHz to 30 GHz, -10 dBm for 30 GHz to 40 GHz, and -15 dBm for 40 GHz to 53 GHz input at test port, 10 MHz tone separations.

**Table 42. Third order intermodulation distortion with low attenuation<sup>1</sup> – characteristic**

P5000B to P5004B, P5020B to P5024B

Description	Distortion (dBc)	TOI (dBm)
50 MHz to 5 GHz	-56	+3
5 GHz to 10 GHz	-52	+1
10 GHz to 20 GHz	-66	+8

P5005B to P5008B, P5025B to P5028B

Description	Distortion (dBc)	TOI (dBm)
50 MHz to 5 GHz	-56	+3
5 GHz to 10 GHz	-52	+1
10 GHz to 20 GHz	-66	+7
20 GHz to 30 GHz	-66	+5
30 GHz to 53 GHz	-66	+2

1. Tested with -25 dBm input at test port, 10 MHz tone separations.

**DANL and distortion relative to test port level (dB) – nominal**

P5000B to P5004B, P5020B to P5024B<sup>1</sup>

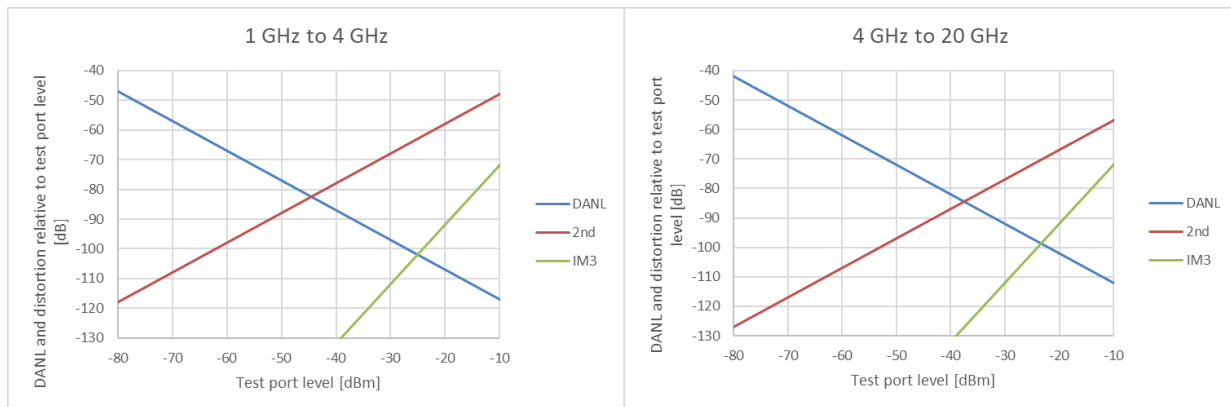

1. With High Attenuation. 2nd harmonic distortion applies up to 10 GHz.

P5005B to P5008B, P5025B to P5028B<sup>2</sup>

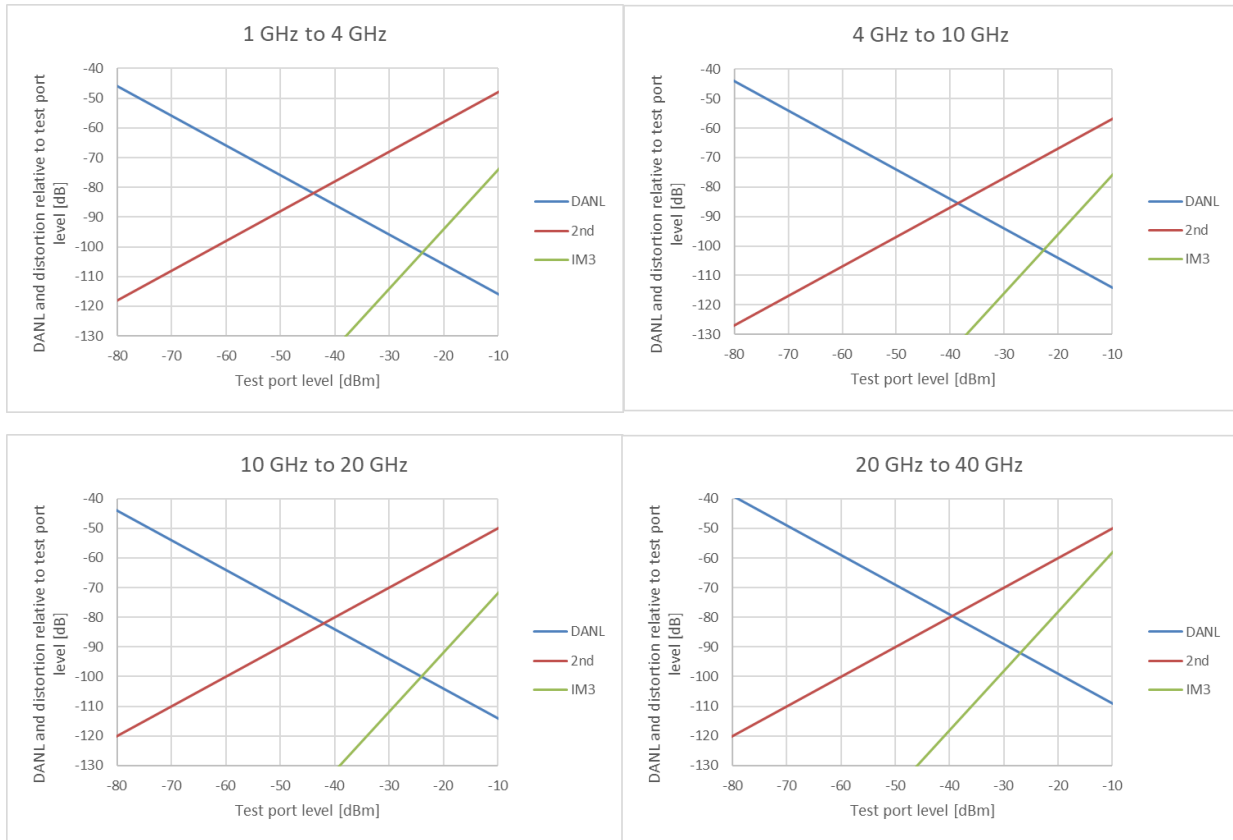

2. With High Attenuation. 2nd harmonic distortion applies up to 26.5 GHz.

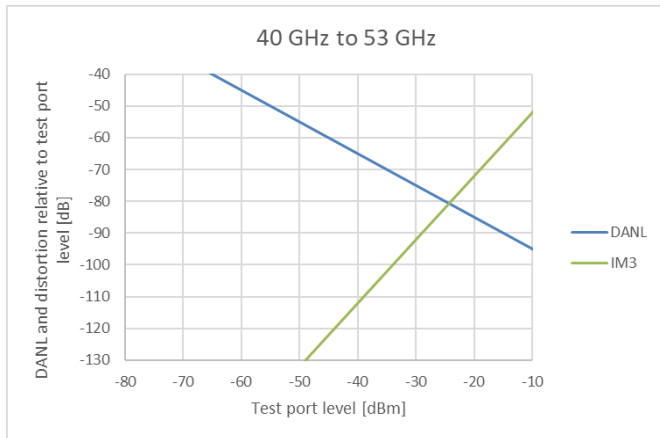

**Table 43. Receiver Phase Noise (dBc/Hz)<sup>1</sup> – Typical**

All models

Description	1 kHz	10 kHz	100 kHz	1 MHz	10 MHz
CF = 1 GHz	-103	-103	-103	-128	-130
CF = 3 GHz	-96	-96	-96	-120	-130
CF = 10 GHz	-83	-83	-83	-116	-127
CF = 20 GHz <sup>2</sup>	-76	-76	-76	-110	-121

1. At maximum specified power. Spurious signals are excluded. With the SA class, phase noise of VNA's source is equivalent to the receiver phase noise.
2. Tested at 19.99 GHz.

## Pulsed-RF Measurements (with S97025xB)

This section provides specifications for the P50xxB Streamline Series VNA. The S97025xB Software is required to enable pulsed-RF measurement functions of the P50xxB VNA.

**Table 44. Pulse modulation On/Off ratio (dB) – typical**

P5000B to P5004B, P5020B to P5024B

Description	Normal Mode <sup>1</sup>	Fast Mode
9 kHz to 4.5 GHz	80	50
4.5 GHz to 15 GHz	70	40
15 GHz to 20 GHz	70	35

P5005B to P5008B, P5025B to P5028B

Description	Normal Mode <sup>1</sup>	Fast Mode
100 kHz to 3 GHz	80	50
3 GHz to 8 GHz	80	40
8 GHz to 20 GHz	80	38
20 GHz to 40 GHz	70	30
40 GHz to 50 GHz	70	25

1. At power of > -20 dBm.

## Pulse modulation shape examples

P5000B to P5004B, P5020B to P5024B

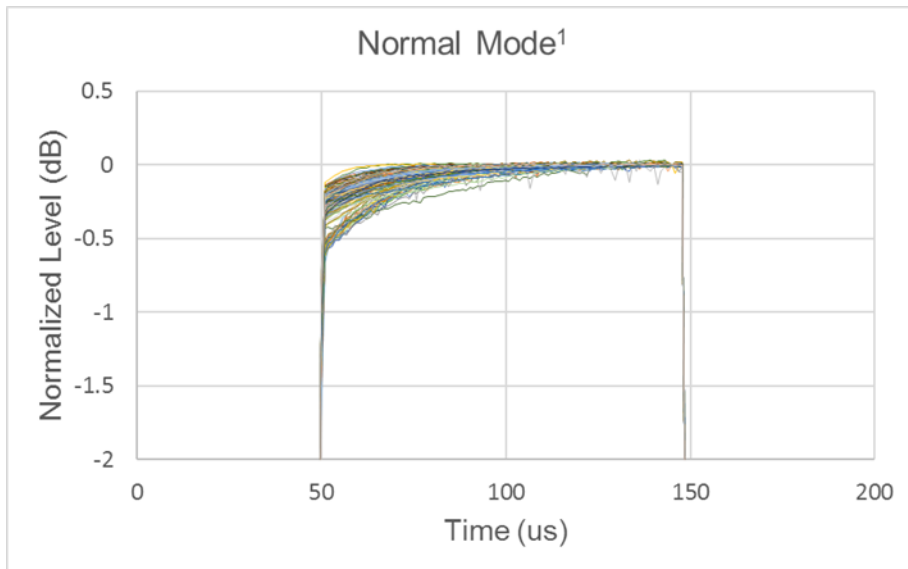

1. Measured with a 500 kHz IF bandwidth, no averaging (Average Type = Point). With 100 us pulse width setting. 50 usec/div.

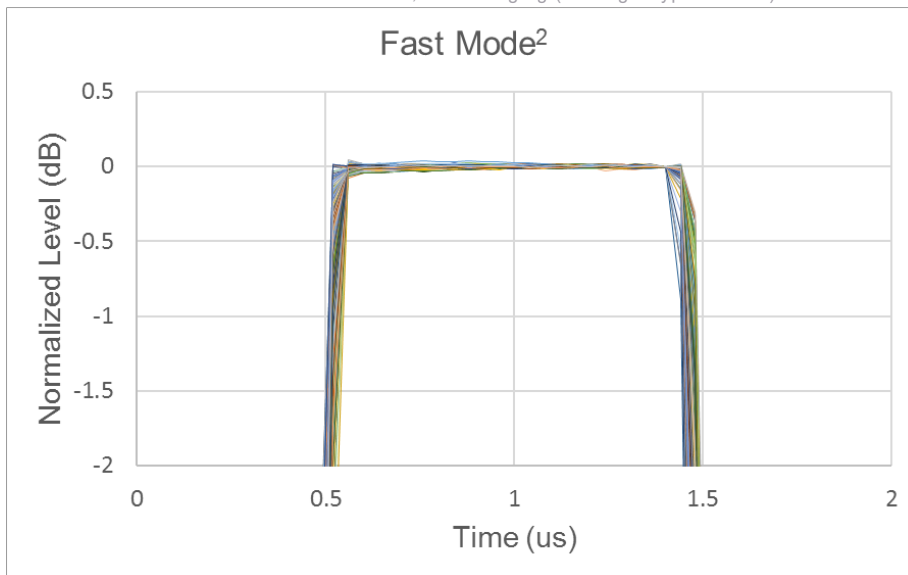

2. Measured with a 15 MHz IF bandwidth, averaging factor of 16 (Average Type = Point). With 1 us pulse width setting. 500 nsec/div.

P5005B to P5008B, P5025B to P5028B

1 GHz to 26.5 GHz

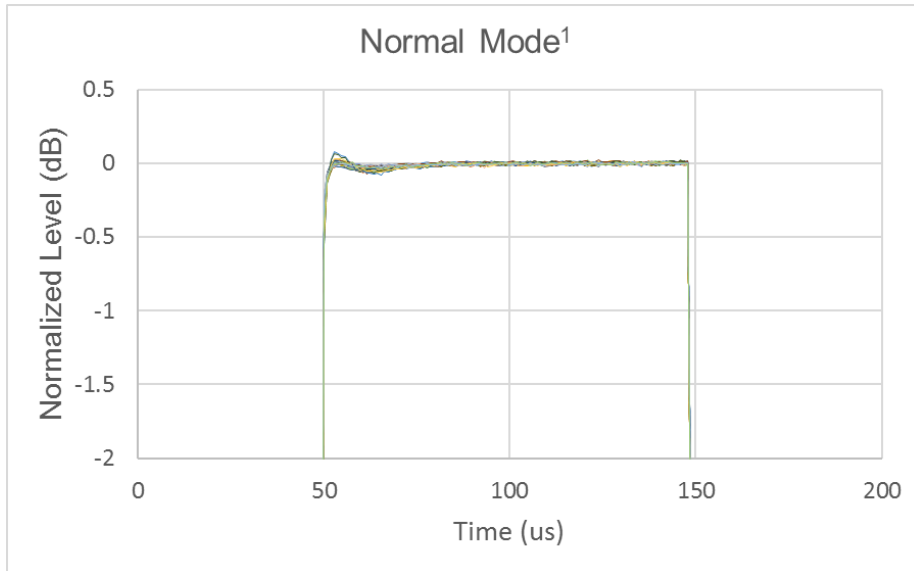

32 GHz

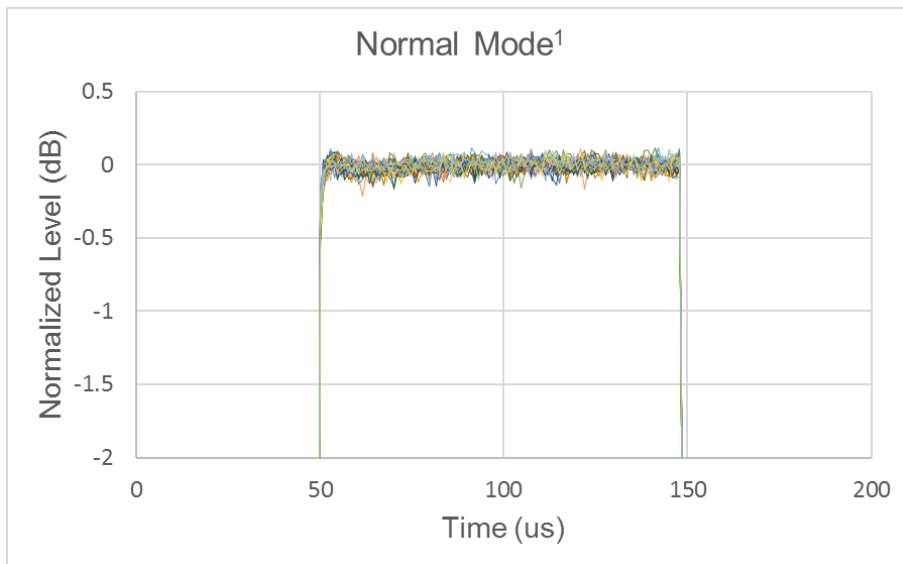



44 GHz

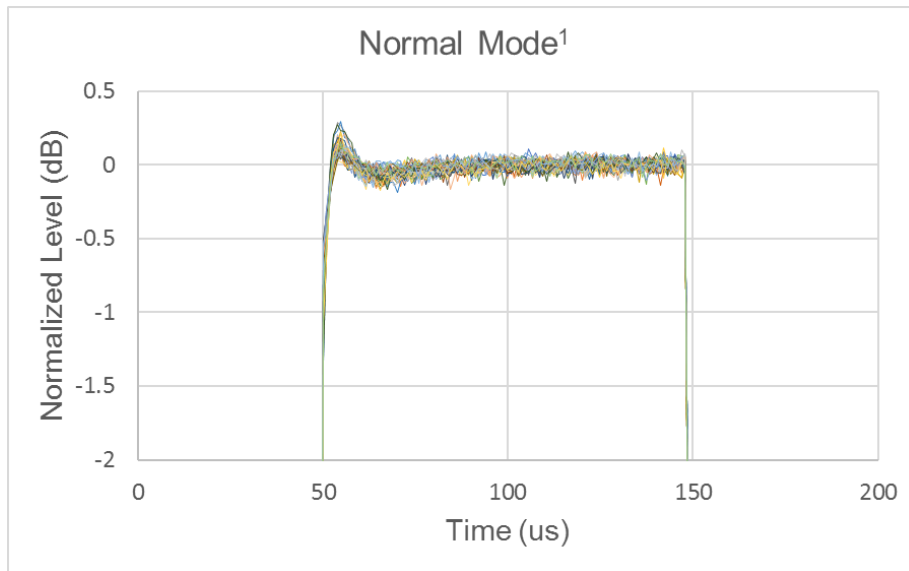

50 GHz

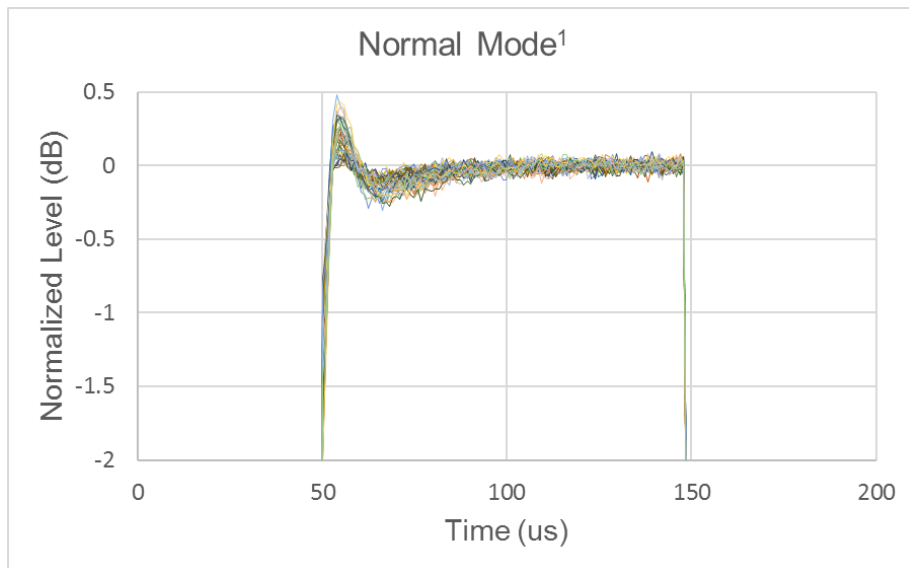

1. Measured with a 500 kHz IF bandwidth, averaging factor of 16 (Average Type = Point). With 100 us pulse width setting. 50 nsec/div.

1 GHz to 26.5 GHz

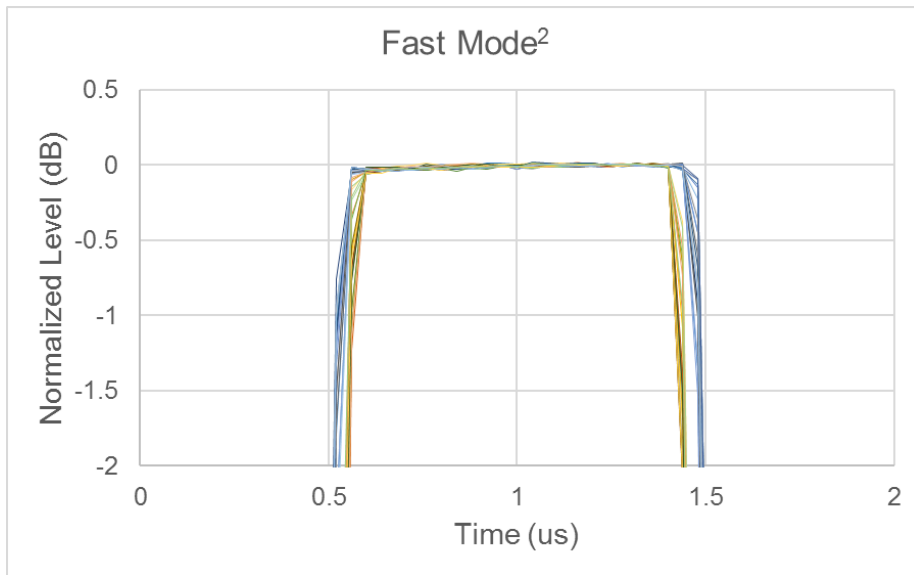

32 GHz

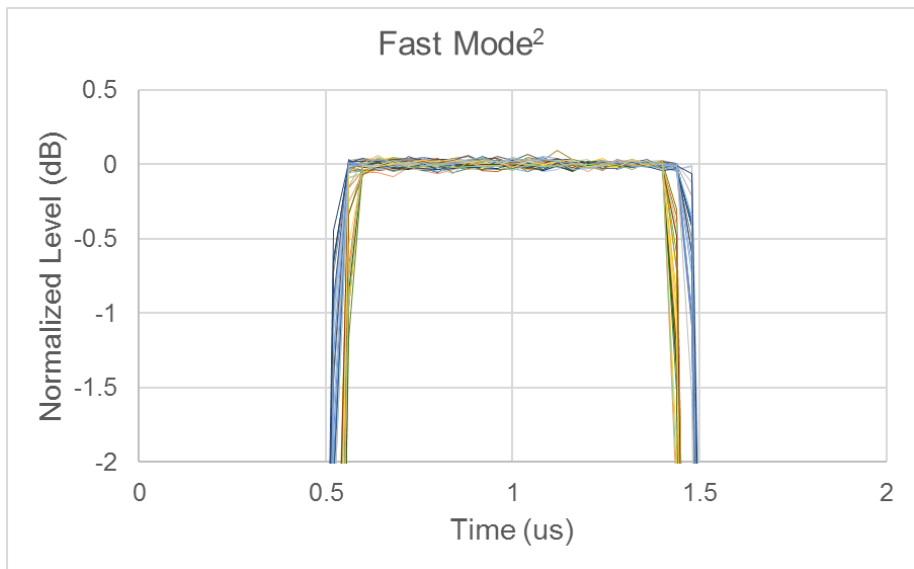

44 GHz

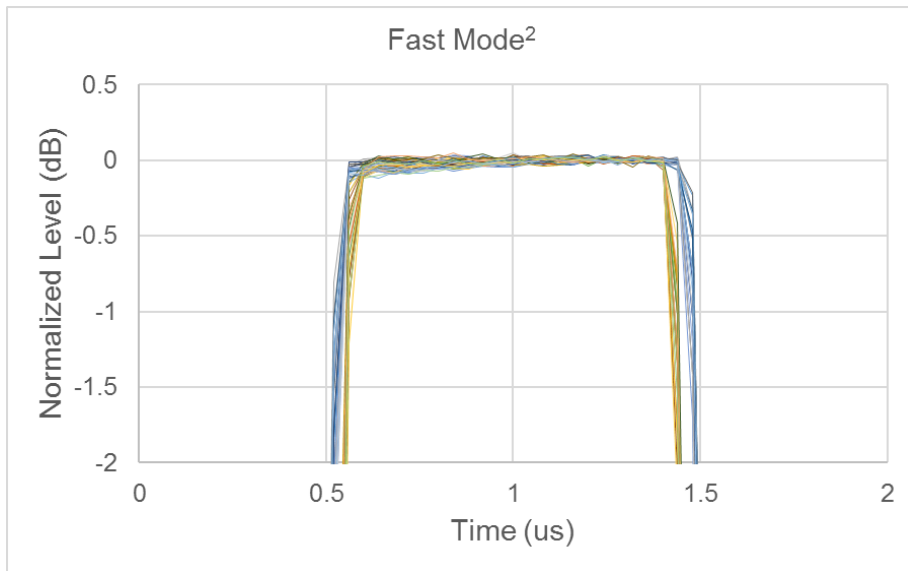

50 GHz

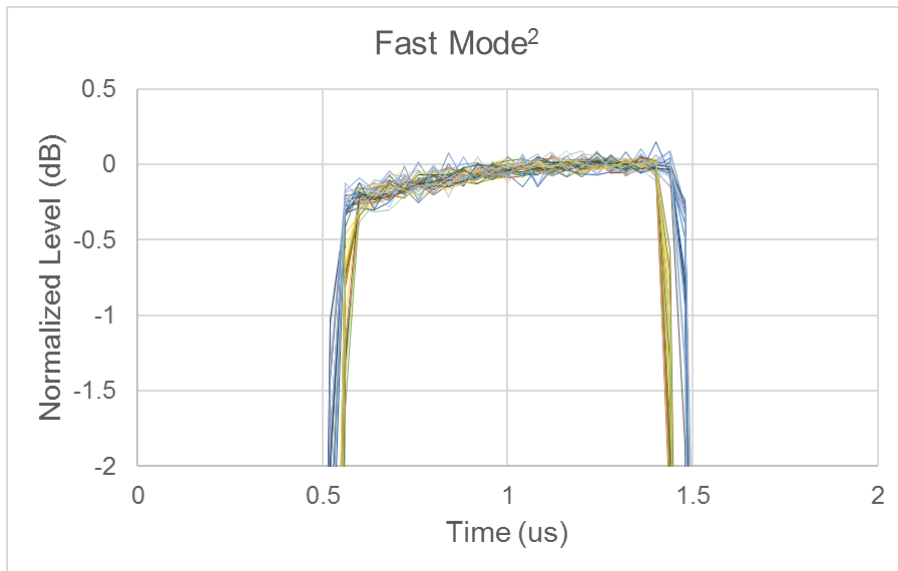

2. Measured with a 15 MHz IF bandwidth, averaging factor of 16 (Average Type = Point). With 1 us pulse width setting. 500 nsec/div.

**Table 45. Pulse modulation (source modulators) - typical**

All models

Description	Typical
Minimum pulse width	200 nsec
Minimum pulse period	1 usec
Maximum pulse period	10 sec

## Enhanced Time Domain Analysis with TDR (S97011B)

This section provides specifications for the enhanced time domain analysis on the P93xxB and P50xxB Streamline Series VNA. The S97011B Software is required to enable enhanced time domain analysis functions of the P93xxB and P50xxB.

**Table 46. Key specifications of enhanced time domain analysis**

P9370B to P9374B, P9382B, P9384B, P5000B to P5004B, P5020B to P5024B

Description		P9374B, P9384B, P5004B, P5024B	P9373B, P5003B, P5023B	P9372B, P9382B, P5002B, P5022B	P9371B, P5001B, P5021B	P9370B, P5000B, P5020B
Bandwidth	Spec.	20 GHz	14 GHz	9 GHz	6.5 GHz	4.5 GHz
Input impedance	Nom.	50 ohm				
DC damage level at test port	Spec.	35 V				
Maximum test port input voltage (Hot TDR mode)	Typ.	1.5 Vpp				
TDR stimulus <sup>1</sup>	Nom.	Step, Impulse				
TDR step amplitude <sup>2</sup>	Nom.	1 mV to 5 V				
TDR step rise time <sup>3</sup> (min) (10% to 90%)	Spec.	22.3 ps	31.9 ps	49.6 ps	68.6 ps	99.1 ps
TDR step response resolution in free space <sup>4</sup> ( $\epsilon_r = 1$ ) (min)	Nom.	3.3 mm	4.8 mm	7.4 mm	10.3 mm	14.9 mm
TDR impulse width (min) <sup>3</sup>	Spec.	30.2 ps	43.1 ps	67.1 ps	92.9 ps	135 ps
TDR deskew range (max) <sup>5</sup> (test cable length)	Typ.	50 ns	50 ns	50 ns	50 ns	50 ns
DUT length (max) <sup>6</sup>	Spec.	13.8 $\mu$ s	13.8 $\mu$ s	13.8 $\mu$ s	13.8 $\mu$ s	13.8 $\mu$ s
TDR stimulus repetition rate (max)	Spec.	19.9 MHz	13.9 MHz	8.9 MHz	6.4 MHz	4.4 MHz
RMS noise level <sup>7</sup>	Typ.	60 $\mu$ Vrms	60 $\mu$ Vrms	60 $\mu$ Vrms	60 $\mu$ Vrms	60 $\mu$ Vrms
Eye diagram data rate (max) <sup>8</sup>	Spec.	16 Gb/s	11.2 Gb/s	7.2 Gb/s	5.2 Gb/s	3.6 Gb/s

P9375B, P9377B, P5005B to P5008B, P5025B to P5028B

Description		P5008B, P5028B	P9377B, P5007B, P5027B	P5006B, P5026B	P9375B, P5005B, P5025B
Bandwidth	Spec.	53 GHz	44 GHz	32 GHz	26.5 GHz
Input impedance	Nom.	50 ohm			
DC damage level at test port	Spec.	35 V			
Maximum test port input voltage (Hot TDR mode)	Typ.	1.5 V (100 kHz to 20 GHz) 0.9 V (20 GHz to 30 GHz) 0.7 V (30 GHz to 40 GHz) 0.5 V (40 GHz to 53 GHz)	1.5 V (100 kHz to 20 GHz) 0.9 V (20 GHz to 30 GHz) 0.7 V (30 GHz to 40 GHz) 0.5 V (40 GHz to 44 GHz)	1.5 V (100 kHz to 20 GHz) 0.9 V (20 GHz to 30 GHz) 0.7 V (30 GHz to 32 GHz)	1.5 V (100 kHz to 20 GHz) 0.9 V (20 GHz to 26.5 GHz)
TDR stimulus <sup>1</sup>	Nom.	Step, Impulse			
TDR step amplitude <sup>2</sup>	Nom.	1 mV to 5 V			
TDR step rise time <sup>3</sup> (min) (10% to 90%)	Spec.	8.42 ps	10.2 ps	14 ps	16.9 ps
TDR step response resolution in free space <sup>4</sup> ( $\epsilon_r = 1$ ) (min)	Nom.	1.3 mm	1.5 mm	2.1 mm	2.5 mm
TDR impulse width (min) <sup>3</sup>	Spec.	11.4 ps	13.8 ps	18.9 ps	22.8 ps
TDR deskew range (max) <sup>5</sup> (test cable length)	Typ.	50 ns	50 ns	50 ns	50 ns
DUT length (max) <sup>6</sup>	Spec.	1.25 $\mu$ s	1.25 $\mu$ s	1.25 $\mu$ s	1.25 $\mu$ s
TDR stimulus repetition rate (max)	Spec.	52.9 MHz	43.9 MHz	31.9 MHz	26.4 MHz
RMS noise level <sup>7</sup>	Typ.	120 $\mu$ Vrms	80 $\mu$ Vrms	80 $\mu$ Vrms	80 $\mu$ Vrms
Eye diagram data rate (max) <sup>8</sup>	Spec	42.4 Gb/s	35.2 Gb/s	25.6 Gb/s	21.2 Gb/s

1. The time domain function of the S97011B is similar to the time domain reflectometry (TDR) measurement on a TDR oscilloscope in that it displays the response in the time domain. In the TDR oscilloscope measurement, a pulse or step stimulus is input to the DUT and the change of the reflected wave over time is measured. In the S97011B TDR measurement, a sine wave stimulus is input to the DUT and the change of the reflected wave over frequency is measured. Then, the frequency domain response is transformed to the time domain using the Inverse Fourier Transform.
2. The TDR step amplitude setting does not vary the actual stimulus level input to the device but is used when calculating the Inverse Fourier Transform.
3. Minimum values may be limited by the DUT length setting.
4. To convert from rise time to response resolution, multiply the rise time by  $c$ , the speed of light in free space. To calculate the actual physical length, multiply this value in free space by  $v_f$ , the relative velocity of propagation in the transmission medium. (Most cables have a relative velocity of 0.66 for a polyethylene dielectric or 0.7 for a PTFE dielectric.)
5. Using high quality cables to connect the DUT is recommended in order to minimize measurement degradation. The cables should have low loss, low reflections, and minimum performance variation when flexed.
6. Maximum DUT length is the sum of the DUT and test cable lengths.
7. RMS noise level with 50  $\Omega$  DUT and default setup.
8. Maximum values may be limited by the DUT length setting.

## Multi-instrument Measurements with S97551B Software

When the S97551B software is installed, Streamline Series VNA have the ability to be configured into a multiport network analyzer with two VNA instruments. Adding a second VNA would provide additional test ports to the VNA. This configuration provides a full featured multiport vector network analyzer capability with full crossbar S-parameter measurement capability.

All models of the P937xB and P938xB, or all models of the P500xB and P502xB can be connected to configure a single multiport VNA. Multiport configurations using up to two VNA instruments have been evaluated. P937xB/P938xB and P500xB/P502xB cannot be connected.

For multi-instrument operation, all single-instrument specifications apply except trace noise, test port noise floor, system dynamic range, Displayed Average Noise Level (DANL) and SA detector accuracy. The other performance of multi-instrument configurations will meet the single-instrument specifications in the data sheet.

The guidance provided here is given as general reference based on Keysight's internal evaluation of multi-instrument configurations. Not all multiport setups using multiple VNAs are tested as a multiport instrument in the factory. Interconnect cables included in the Y1701A must be used for connection between two VNAs.

**Table 47. Multi-instrument performance**

- A check mark, ✓, indicates the performance parameter is the same as the corresponding single-instrument performance.
- An empty diamond, ◇, indicates that the performance parameter may be degraded as the number of instruments increases.

Description	Setups with 2 VNAs
System Dynamic Range	◇ (see Table 48)
Frequency Accuracy	✓
Uncorrected Directivity	✓
Uncorrected Load Match	✓
Uncorrected Source Match	✓
Maximum Output Port Power	✓
Power Level Accuracy	✓
Power Level Linearity	✓
Noise Floor	◇ (see Table 49)
Receiver Compression	✓
Trace Noise	◇ (see Table 50 and 51)
Dynamic Accuracy	✓
Crosstalk	✓

**Table 48. System dynamic range of multi-instrument configurations (dB)<sup>1</sup>**

P9370B to P9374B, P9382B, P9384B

Description	Setups with 2 VNAs	
	Char.	Typical
9 kHz to 100 kHz	84	94
100 kHz to 10 MHz	108	117
10 MHz to 50 MHz <sup>2</sup>	111	120
50 MHz to 3 GHz	115	124
3 GHz to 6.5 GHz	115	122
6.5 GHz to 9 GHz	112	120
9 GHz to 14 GHz	111	120
14 GHz to 16 GHz	108	118
16 GHz to 20 GHz	105	115

P9375B, P9377B

Description	Setups with 2 VNAs	
	Char.	Typical
100 kHz to 300 kHz	93	106
300 kHz to 1 MHz	102	115
1 MHz to 50 MHz <sup>2</sup>	112	120
50 MHz to 3 GHz	115	124
3 GHz to 6.5 GHz	115	122
6.5 GHz to 17 GHz	112	120
17 GHz to 20 GHz	110	119
20 GHz to 24 GHz	108	119
24 GHz to 30 GHz	108	117
30 GHz to 38 GHz	102	115
38 GHz to 44 GHz	102	112

P5000B to P5004B, P5020B to P5024B

Description	Setups with 2 VNAs	
	Char.	Typical
9 kHz to 100 kHz	101	110
100 kHz to 300 kHz	117	126
300 kHz to 1 MHz	125	136
1 MHz to 10 MHz	130	141
10 MHz to 50 MHz <sup>2</sup>	137	147
50 MHz to 3 GHz	140	150
3 GHz to 4.5 GHz	140	149
4.5 GHz to 5 GHz	140	149
5 GHz to 6.5 GHz	140	148
6.5 GHz to 9 GHz	136	146
9 GHz to 14 GHz	133	142
14 GHz to 16 GHz	127	140
16 GHz to 20 GHz	124	137

P5005B to P5008B, P5025B to P5028B

Description	Setups with 2 VNAs	
	Char.	Typical
100 kHz to 300 kHz	95	106
300 kHz to 500 kHz	104	120
500 kHz to 1 MHz	117	130
1 MHz to 10 MHz	125	138
10 MHz to 50 MHz <sup>2</sup>	137	147
50 MHz to 6.5 GHz	140	150
6.5 GHz to 8 GHz	138	150
8 GHz to 9 GHz	138	147
9 GHz to 16 GHz	137	147
16 GHz to 17 GHz	137	143
17 GHz to 20 GHz	132	143
20 GHz to 24 GHz	130	143
24 GHz to 25 GHz	130	141
25 GHz to 26 GHz	127	141
26 GHz to 30 GHz	127	137
30 GHz to 35 GHz	122	137
35 GHz to 40 GHz	122	134
40 GHz to 45 GHz	122	132
45 GHz to 50 GHz	100	115
50 GHz to 53 GHz	72	101

1. System dynamic range = source maximum output power minus receiver noise floor at 10 Hz IF bandwidth. Does not include crosstalk effects.
2. It may typically be degraded at 25 MHz.

**Table 49. Test port noise floor of multi-instrument configurations (dBm)<sup>1</sup>**

P9370B to P9374B, P9382B, P9384B

Description	Setups with 2 VNAs	
	Char.	Typical
9 kHz to 100 kHz	-84	-92
100 kHz to 50 MHz <sup>2</sup>	-103	-110
50 MHz to 3 GHz	-107	-114
3 GHz to 6.5 GHz	-107	-112
6.5 GHz to 14 GHz	-104	-110
14 GHz to 20 GHz	-101	-108



P9375B, P9377B

Description	Setups with 2 VNAs	
	Char.	Typical
100 kHz to 1 MHz	-95	-105
1 MHz to 50 MHz <sup>2</sup>	-104	-110
50 MHz to 3 GHz	-107	-114
3 GHz to 6.5 GHz	-107	-112
6.5 GHz to 17 GHz	-104	-110
17 GHz to 30 GHz	-103	-109
30 GHz to 44 GHz	-100	-107

P5000B to P5004B, P5020B to P5024B

Description	Setups with 2 VNAs	
	Char.	Typical
9 kHz to 100 kHz	-101	-109
100 kHz to 300 kHz	-112	-119
300 kHz to 1 MHz	-120	-127
1 MHz to 10 MHz	-125	-132
10 MHz to 50 MHz <sup>2</sup>	-127	-134
50 MHz to 3 GHz	-130	-137
3 GHz to 4.5 GHz	-130	-136
4.5 GHz to 6.5 GHz	-130	-135
6.5 GHz to 9 GHz	-127	-134
9 GHz to 14 GHz	-126	-132
14 GHz to 16 GHz	-120	-130
16 GHz to 20 GHz	-120	-130

P5005B to P5008B, P5025B to P5028B

Description	Setups with 2 VNAs	
	Char.	Typical
100 kHz to 300 kHz	-97	-105
300 kHz to 500 kHz	-97	-110
500 kHz to 1 MHz	-110	-120
1 MHz to 10 MHz	-115	-124
10 MHz to 50 MHz <sup>2</sup>	-127	-133
50 MHz to 200 MHz	-130	-133
200 MHz to 3 GHz	-130	-137
3 GHz to 6.5 GHz	-130	-135
6.5 GHz to 9 GHz	-128	-134
9 GHz to 17 GHz	-127	-133
17 GHz to 25 GHz	-125	-131
25 GHz to 30 GHz	-122	-129
30 GHz to 45 GHz	-120	-127
45 GHz to 50 GHz	-105	-115
50 GHz to 53 GHz	-95	-113

1. Noise floor in a 10 Hz IF Bandwidth. Measured with 1 kHz IF bandwidth for 9 kHz to < 100 kHz, and 30 kHz IF bandwidth for 100 kHz to 53 GHz. Test port terminated.
2. It may typically be degraded at 25 MHz.

**Table 50. Trace noise magnitude of multi-instrument configurations (dB rms)<sup>1</sup>**

P9370B to P9374B, P9382B, P9384B

Description	Setups with 2 VNAs	
	Char.	Typical
9 kHz to 30 kHz	0.005	0.0025
30 kHz to 100 kHz	0.003	0.001
100 kHz to 10 MHz	0.0021	0.0007
10 MHz to 6 GHz <sup>2</sup>	0.0015	0.0005
6 GHz to 10 GHz	0.002	0.0006
10 GHz to 20 GHz	0.003	0.001

P9375B, P9377B

Description	Setups with 2 VNAs	
	Char.	Typical
100 kHz to 300 kHz	0.005	0.002
300 kHz to 1 MHz	0.003	0.001
1 MHz to 4.5 GHz <sup>2</sup>	0.0018	0.0006
4.5 GHz to 10 GHz	0.0023	0.001
10 GHz to 17 GHz	0.003	0.0015
17 GHz to 30 GHz	0.0036	0.0015
30 GHz to 44 GHz	0.0072	0.0027

P5000B to P5004B, P5020B to P5024B

Description	Setups with 2 VNAs	
	Char.	Typical
9 kHz to 30 kHz	0.005	0.0025
30 kHz to 100 kHz	0.003	0.001
100 kHz to 10 MHz	0.0025	0.0005
10 MHz to 6 GHz <sup>2</sup>	0.002	0.0005
6 GHz to 10 GHz	0.002	0.0006
10 GHz to 13.5 GHz	0.003	0.001
13.5 GHz to 20 GHz	0.004	0.001

P5005B to P5008B, P5025B to P5028B

Description	Setups with 2 VNAs	
	Char.	Typical
100 kHz to 300 kHz	0.005	0.002
300 kHz to 1 MHz	0.003	0.001
1 MHz to 4.5 GHz <sup>2</sup>	0.0015	0.0005
4.5 GHz to 10 GHz	0.0015	0.0007
10 GHz to 17 GHz	0.002	0.001
17 GHz to 30 GHz	0.003	0.0013
30 GHz to 45 GHz	0.006	0.0022
45 GHz to 50 GHz	0.018	0.006

1. Reflection trace noise in a 1 kHz IF bandwidth for < 10 MHz, 10 kHz IF bandwidth ≥ 10 MHz. At maximum specified power.
2. It may typically be degraded at particular frequencies such as 25 MHz, 54 MHz, 58.5 MHz, 156 MHz, 108 MHz, 120 MHz or 132 MHz.

**Table 51. Trace noise phase of multi-instrument configurations (degree rms)<sup>1</sup>**

P9370B to P9374B, P9382B, P9384B

Description	Setups with 2 VNAs	
	Char.	Typical
9 kHz to 30 kHz	0.07	0.025
30 kHz to 100 kHz	0.05	0.017
100 kHz to 300 kHz	0.035	0.006
300 kHz to 6 GHz <sup>2</sup>	0.01	0.003
6 GHz to 10 GHz	0.02	0.006
10 GHz to 13.5 GHz	0.03	0.006
13.5 GHz to 20 GHz	0.03	0.01

P9375B, P9377B

Description	Setups with 2 VNAs	
	Char.	Typical
100 kHz to 300 kHz	0.07	0.015
300 kHz to 1 MHz	0.03	0.01
1 MHz to 6 GHz <sup>2</sup>	0.024	0.0036
6 GHz to 10 GHz	0.024	0.0048
10 GHz to 17 GHz	0.024	0.0072
17 GHz to 30 GHz	0.032	0.016
30 GHz to 44 GHz	0.048	0.022

P5000B to P5004B, P5020B to P5024B

Description	Setups with 2 VNAs	
	Char.	Typical
9 kHz to 30 kHz	0.07	0.025
30 kHz to 100 kHz	0.05	0.017
100 kHz to 300 kHz	0.035	0.006
300 kHz to 10 MHz	0.015	0.003
10 MHz to 6 GHz <sup>2</sup>	0.015	0.003
6 GHz to 10 GHz	0.025	0.006
10 GHz to 13.5 GHz	0.036	0.006
13.5 GHz to 20 GHz	0.045	0.01

P5005B to P5008B, P5025B to P5028B

Description	Setups with 2 VNAs	
	Char.	Typical
100 kHz to 300 kHz	0.07	0.015
300 kHz to 1 MHz	0.03	0.01
1 MHz to 6 GHz <sup>2</sup>	0.02	0.003
6 GHz to 10 GHz	0.02	0.004
10 GHz to 17 GHz	0.02	0.006
17 GHz to 30 GHz	0.02	0.01
30 GHz to 45 GHz	0.04	0.018
45 GHz to 50 GHz	0.18	0.03

1. Reflection trace noise in a 1 kHz IF bandwidth for < 10 MHz, 10 kHz IF bandwidth ≥ 10 MHz. At maximum specified power.
2. It may typically be degraded at particular frequencies such as 25 MHz, 54 MHz, 58.5 MHz, 156 MHz, 108 MHz, 120 MHz or 132 MHz.

## Multi-site Operation

Multi-site operation is the ability to configure multiple Streamline Series VNAs to operate independently on a single host PC via Thunderbolt 3 connection. Up to two independent VNA instances per PC have been evaluated, allowing parallel testing of devices. Each instance of an independent VNA can have different measurement parameters, and can be triggered synchronously, or asynchronously.

## General Information

**Table 52. Miscellaneous information**

Description	Specification
System IF Bandwidth Range	1 Hz to 700 kHz (P9370B to P9377B, P9382B, P9384B) 1 Hz to 15 MHz (P5000B to P5008B, P5020B to P5028B)
Number of points	1 to 100,003





**Table 53. External PC system requirements**

PC System Requirement	
Operating Systems	Windows 10 (64-bit only) Version 1909 or later
Available Memory	16 GB recommended, 4 GB minimum
Available Disk space	2 GB available disk space minimum
Display resolution	1024 x 768 minimum
Connection with VNA	Thunderbolt 3
Recommended CPU	Intel Core i7 10 <sup>th</sup> Generation or later
Instrument Drivers	
Keysight IO Libraries	IO Libraries Suite 2021 Update 1 (Release date: 2021-07-23) or later

**Table 54. Environmental and physical specifications**

Descriptions	Samples of this product have been type tested in accordance with the Keysight Environmental Test Manual and verified to be robust against the environmental stresses of Storage, Transportation and End-use; those stresses include, but are not limited to, temperature, humidity, shock, vibration, altitude, and power line conditions. Test Methods are aligned with IEC 60068-2 and levels are similar to MIL-PRF-28800F Class 3.	
Temperature	Operating	0 to 50 °C ambient 10 to 70 °C instrument temperature
	Non-operating	-40 to 70 °C
Humidity	Operating	Type tested at 20 to 80 %, wet bulb temperature < 29 °C (non-condensing)
	Non-operating	Type tested at 20 to 90 %, wet bulb temperature < 40 °C (non-condensing)
Altitude	Operating	Up to 2,000 meters (6,561 feet)
	Non-operating	Up to 4,572 meters (15,000 feet)
Vibration	Operating	0.3 G maximum, 5 Hz to 500 Hz
	Non-operating	0.75 G maximum, 5 Hz to 500 Hz
Instrument protection	IP 30 IEC/EN 60529	
Warm-up time	60 minutes	

**Table 55. Regulatory and safety compliance**

EMC <sup>1</sup>			
Complies with the essential requirements of the European EMC Directive as well as current editions of the following standards (dates and editions are cited in the Declaration of Conformity).			
	<p>The CE mark is a registered trademark of the European Community (if accompanied by a year, it is the year when the design was proven). This product complies with all relevant directives.</p> <ul style="list-style-type: none"> <li>• IEC 61326-1</li> <li>• CISPR 11 Group 1, Class A</li> </ul>		
	UK conformity mark is a UK government owned mark. When affixed to the product is declaring all applicable Directives and Regulations have been met in full.		
CAN ICES/NMB-001(A)	This ISM device complies with Canadian ICES-001. Cet appareil ISM est conforme a la norme NMB du Canada.		
	<p>The RCM mark is a registered trademark of the Australian Communications and Media Authority.</p> <ul style="list-style-type: none"> <li>• AS/NZS CISPR 11</li> </ul>		
	<p>South Korean Certification (KC) mark; includes the marking's identifier code: R-R-Kst-xxxxxxx</p> <p>South Korean Class A EMC declaration: Information to the user: This equipment has been conformity assessed for use in business environments. In a residential environment this equipment may cause radio interference. ※ This EMC statement applies to the equipment only for use in business environment.</p> <table border="1" style="width: 100%; border-collapse: collapse;"> <tr> <td style="text-align: center; background-color: #d9e1f2;">사 용 자 안 내 문</td> </tr> <tr> <td style="text-align: center;">이 기기는 업무용 환경에서 사용할 목적으로 적합성평가를 받은 기기로서 가정용 환경에서 사용하는 경우 전파간섭의 우려가 있습니다.</td> </tr> </table> <p>※ 사용자 안내문은 “업무용 방송통신기자재”에만 적용한다.</p>	사 용 자 안 내 문	이 기기는 업무용 환경에서 사용할 목적으로 적합성평가를 받은 기기로서 가정용 환경에서 사용하는 경우 전파간섭의 우려가 있습니다.
사 용 자 안 내 문			
이 기기는 업무용 환경에서 사용할 목적으로 적합성평가를 받은 기기로서 가정용 환경에서 사용하는 경우 전파간섭의 우려가 있습니다.			
Instrument calibration cycle	1 year		

1. To find a current Declaration of Conformity for a specific Keysight product, go to: <http://www.keysight.com/go/conformity>.

**Table 56. Physical size and weight**

P9370B to P9374B, P9382B, P9384B, P5000B to P5004B, P5020B to P5024B

Dimensions / Weight	2-port	4 or 6-port	Note
Width	176 mm (6.93 in.)	176 mm (6.93 in.)	
Height	48 mm (1.89 in.)	68 mm (2.68 in.)	
Depth	333 mm (13.11 in.)	333 mm (13.11 in.)	
Weight	1.88 kg (4.14 lbs)	2.82 kg (6.22 lbs, 4-port) 2.98 kg (6.57 lbs, 6-port)	

P9375B, P9377B, P5005B to P5008B, P5025B to P5028B

Dimensions / Weight	2-port	4-port	Note
Width	176 mm (6.93 in.)	176 mm (6.93 in.)	
Height	48 mm (1.89 in.)	68 mm (2.68 in.)	
Depth	333 mm (13.11 in.)	333 mm (13.11 in.)	
Weight	2.02 kg (4.45 lbs)	3.18 kg (7.01 lbs)	

**Table 57. Electrical power**

P9370B to P9374B, P9382B, P9384B, P5000B to P5004B, P5020B to P5024B

Description	2-port	4 or 6-port
Wall Outlet	120 V, 66 W (maximum) 240 V, 68 W (maximum)	120 V, 94 W (maximum, 4-port) 240 V, 96 W (maximum, 4-port) 120 V, 124 W (maximum, 6-port) 240 V, 126 W (maximum, 6-port)
Rear Panel DC Connector	15 V, 58 W	19 V, 84 W (4-port) 19 V, 110 W (6-port)

P9375B, P9377B, P5005B to P5008B, P5025B to P5028B

Description	2-port	4-port
Wall Outlet	120 V, 66 W (maximum) 240 V, 68 W (maximum)	120 V, 116 W (maximum) 240 V, 118 W (maximum)
Rear Panel DC Connector	15 V, 58 W	19 V, 102 W

**Table 58. Front panel information**

Description	
<b>Test Port</b>	
Connector Type	3.5 mm female (P9370B to P9375B, P9382B, P9384B, P5000B to P5005B, P5020B to P5025B) 2.4 mm female (P9377B, P5006B, P5007B, P5026B, P5027B) 1.85 mm female (P5008B, P5028B)
Impedance	50 ohm (nominal)
<b>External Reference Input</b>	
Connector Type	MCX
Input amplitude range	-3 to +10 dBm
Input frequency <sup>1</sup>	10 MHz $\pm$ 10 ppm
Impedance	50 ohm (nominal)
<b>External Reference Output</b>	
Connector Type	MCX
Output amplitude range	0 to $\pm$ 3 dBm
Output frequency	10 MHz $\pm$ 7 ppm
Impedance	50 ohm (nominal)

1. Input frequency reference of 100 MHz is also acceptable with some limitations. See [VNA webhelp](#) for more details.

**Table 59. Rear panel information**

Description	
USB Ports	Type A female (USB 2.0 only, Downstream-facing), 2 ports
Thunderbolt 3 Ports	USB Type-C, 2 ports
Power Connector	Kycon KPJX-4S-S DC power connector (4 pins)
10 MHz In (SMB)	10 MHz $\pm$ 25 ppm (not used by Streamline Series VNA)
10 MHz Out (SMB)	10 MHz $\pm$ 25 ppm (not used by Streamline Series VNA)
Trig 1	3.3 V CMOS (TTL compatible, 5 V tolerant)
Trig 2	3.3 V CMOS (TTL compatible, 5 V tolerant)



## Measurement Throughput Summary

**Table 60. Cycle time for measurement completion (milliseconds)<sup>1</sup> – typical**

P9370B to P9374B, P9382B, P9384B

Description	Sweep mode: Stepped		
<b>10 MHz – 9 GHz frequency span, 700 kHz IF bandwidth</b>			
<b>Number of points</b>	<b>201</b>	<b>401</b>	<b>1601</b>
Uncorrected	10.3	18.6	63.2
2-port Calibration	20.1	36.8	126.0
4-port Calibration	39.7	72.8	251.3
<b>10 MHz – 20 GHz frequency span, 700 kHz IF bandwidth</b>			
<b>Number of points</b>	<b>201</b>	<b>401</b>	<b>1601</b>
Uncorrected	10.8	18.8	65.4
2-port Calibration	21.1	37.1	130.2
4-port Calibration	41.6	73.5	259.9
<b>800 MHz – 1 GHz frequency span, 700 kHz IF bandwidth</b>			
<b>Number of points</b>	<b>201</b>	<b>401</b>	<b>1601</b>
Uncorrected	7.7	14.5	54.0
2-port Calibration	14.9	28.4	107.3
4-port Calibration	29.4	56.4	213.8
<b>9 GHz – 10 GHz frequency span, 700 kHz IF bandwidth</b>			
<b>Number of points</b>	<b>201</b>	<b>401</b>	<b>1601</b>
Uncorrected	7.9	14.9	55.7
2-port Calibration	15.4	29.3	110.8
4-port Calibration	30.3	58.1	220.9

P9375B, P9377B

Description	Sweep mode: Stepped		
<b>9 GHz – 10 GHz frequency span, 700 kHz IF bandwidth</b>			
<b>Number of points</b>	<b>201</b>	<b>401</b>	<b>1601</b>
Uncorrected	7.9	14.9	55.6
2-port Calibration	15.4	29.3	110.7
<b>10 MHz – 26.5 GHz frequency span, 700 kHz IF bandwidth</b>			
<b>Number of points</b>	<b>201</b>	<b>401</b>	<b>1601</b>
Uncorrected	11.1	19.2	66.4
2-port Calibration	21.7	37.9	132.3
<b>10 MHz – 44 GHz frequency span, 700 kHz IF bandwidth</b>			
<b>Number of points</b>	<b>201</b>	<b>401</b>	<b>1601</b>
Uncorrected	11.4	19.7	67.8
2-port Calibration	22.2	38.9	135.0

P5000B to P5004B, P5020B to P5024B

Description	Sweep mode: Auto			Sweep mode: Stepped		
<b>10 MHz – 9 GHz frequency span, 1 MHz IF bandwidth</b>						
<b>Number of points</b>	<b>201</b>	<b>401</b>	<b>1601</b>	<b>201</b>	<b>401</b>	<b>1601</b>
Uncorrected	4.2	5.9	11.1	4.2	6.4	14.0
2-port Calibration	7.9	11.3	21.8	7.9	12.2	27.6
4-port Calibration	15.7	22.9	44.4	15.7	24.7	55.5
6-port Calibration	23.1	33.7	65.1	23.0	36.3	82.1
<b>10 MHz – 20 GHz frequency span, 1 MHz IF bandwidth</b>						
<b>Number of points</b>	<b>201</b>	<b>401</b>	<b>1601</b>	<b>201</b>	<b>401</b>	<b>1601</b>
Uncorrected	4.7	6.5	10.3	4.6	6.5	16.1
2-port Calibration	8.8	12.5	20.3	8.8	12.4	31.8
4-port Calibration	17.6	25.1	41.1	17.6	25.0	63.8
6-port Calibration	25.8	37.2	60.4	25.8	37.0	95.1
<b>800 MHz – 1 GHz frequency span, 1 MHz IF bandwidth</b>						
<b>Number of points</b>	<b>201</b>	<b>401</b>	<b>1601</b>	<b>201</b>	<b>401</b>	<b>1601</b>
Uncorrected	1.1	1.5	3.6	1.5	2.0	4.3
2-port Calibration	1.8	2.5	6.7	2.4	3.5	8.3
4-port Calibration	3.4	5.1	13.7	4.6	7.2	16.6
6-port Calibration	4.8	7.3	20.1	6.9	10.4	24.6
<b>9 GHz – 10 GHz frequency span, 1 MHz IF bandwidth</b>						
<b>Number of points</b>	<b>201</b>	<b>401</b>	<b>1601</b>	<b>201</b>	<b>401</b>	<b>1601</b>
Uncorrected	1.1	1.5	3.6	1.7	2.4	6.1
2-port Calibration	1.7	2.5	6.7	3.0	4.4	11.8
4-port Calibration	3.4	4.9	13.7	5.5	8.6	23.9
6-port Calibration	4.8	7.3	20.1	8.2	13.1	35.2

P5005B to P5008B, P5025B to P5028B

Description	Sweep mode: Auto			Sweep mode: Stepped		
9 GHz – 10 GHz frequency span, 1 MHz IF bandwidth						
Number of points	201	401	1601	201	401	1601
Uncorrected	1.3	1.9	5.4	1.6	2.4	6.0
2-port Calibration	2.1	3.3	10.4	2.8	4.3	11.7
4-port Calibration	4.2	6.8	21.2	5.3	8.5	23.7
10 MHz – 26.5 GHz frequency span, 1 MHz IF bandwidth						
Number of points	201	401	1601	201	401	1601
Uncorrected	5.0	7.4	11.0	5.0	6.9	17.2
2-port Calibration	9.5	13.3	21.6	9.4	13.3	33.9
4-port Calibration	18.9	26.7	43.7	18.9	26.7	68.0
10 MHz – 40 GHz frequency span, 1 MHz IF bandwidth						
Number of points	201	401	1601	201	401	1601
Uncorrected	5.1	7.5	12.7	5.2	7.5	17.9
2-port Calibration	9.8	14.5	24.9	9.8	14.5	35.2
4-port Calibration	19.7	29.4	50.4	19.7	29.3	70.7
10 MHz – 53 GHz frequency span, 1 MHz IF bandwidth						
Number of points	201	401	1601	201	401	1601
Uncorrected	5.5	7.7	15.4	5.6	7.8	19.0
2-port Calibration	10.6	15.0	30.5	10.6	15.0	37.4
4-port Calibration	21.3	30.3	61.3	21.3	30.3	75.4

1. Analyzer display turned off with DISPLAY:VISible OFF. Measured using a host PC with Intel Core i5-10310U 1.70 GHz CPU and 16 GB RAM running Windows 10 (64 bit), with Keysight VNA firmware version A.15.20.0x. Data for one trace (S11) measurement. Uncorrected measurements are for one sweep direction.

**Table 61. Software**

Description	Information
Keysight IO library	The IO library suite offers a single entry point for connection to the most common instruments including AXIe, PXI, GPIB, USB, Ethernet/LAN, RS-232, and VXI test instrument from Keysight and other vendors. It automatically discovers interfaces, chassis, and instruments. The graphical user interface allows you to search for, verify, and update IVI instrument and soft front panel drivers for modular and traditional instruments. The IO suite safely installs in side-by-side mode with NI I/O software. Free software download at <a href="http://www.keysight.com/find/iosuite">www.keysight.com/find/iosuite</a>
Keysight soft front panel	Keysight Streamline Series VNA includes a soft front panel (SFP), a software based graphical user interface (GUI) which enables the instrument's capabilities from your PC.
Command Expert	Assists in finding the right instrument commands and setting correct parameters. A simple interface includes documentation, examples, syntax checking, command execution, and debug tools to build sequences for integration in Excel, MATLAB, LabVIEW, VEE, and System VUE. Free software download at <a href="http://www.keysight.com/find/commandexpert">www.keysight.com/find/commandexpert</a>
Example programs	Setting up a measurement Guided calibration Data acquisition Data transfer
Example programming languages	C, C++, C#, VB, LabVIEW

# Test Set Block Diagrams

## Legends

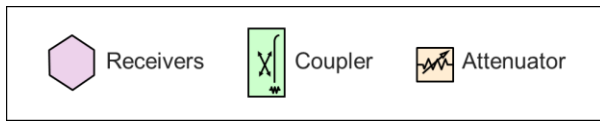

P937xB or P500xB Option 200 (2-port base model)

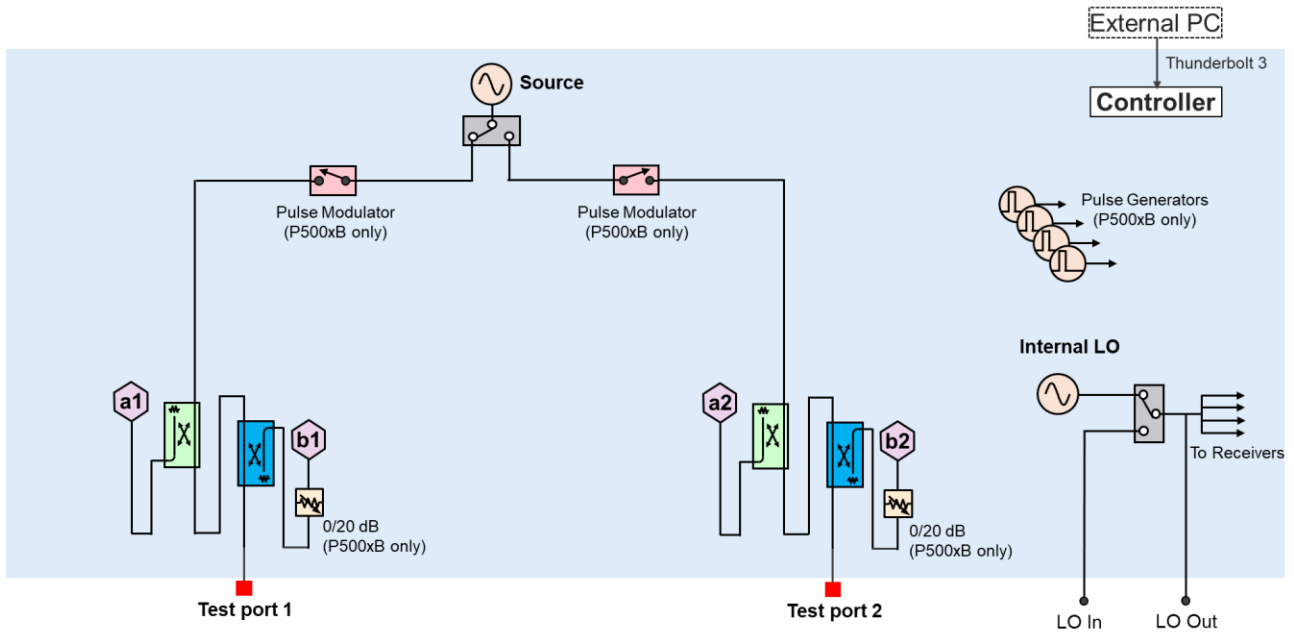

P938xB or P502xB Option 400 (4-port base model)

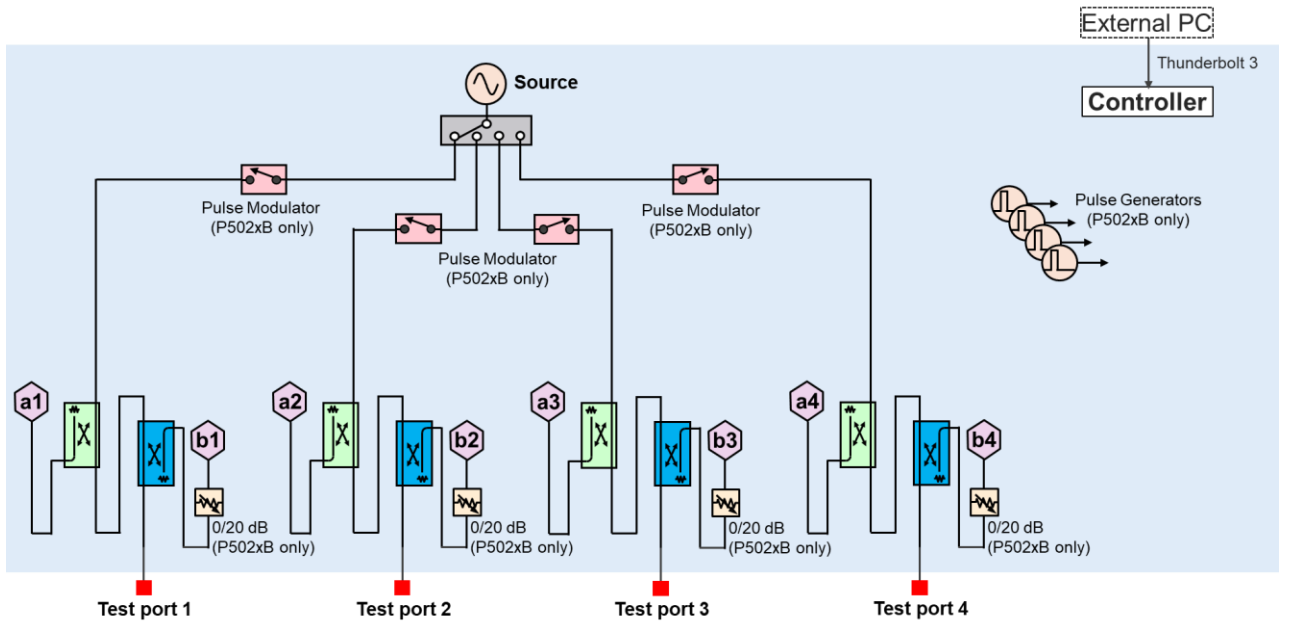

P502xB Option 402 (with internal second source)

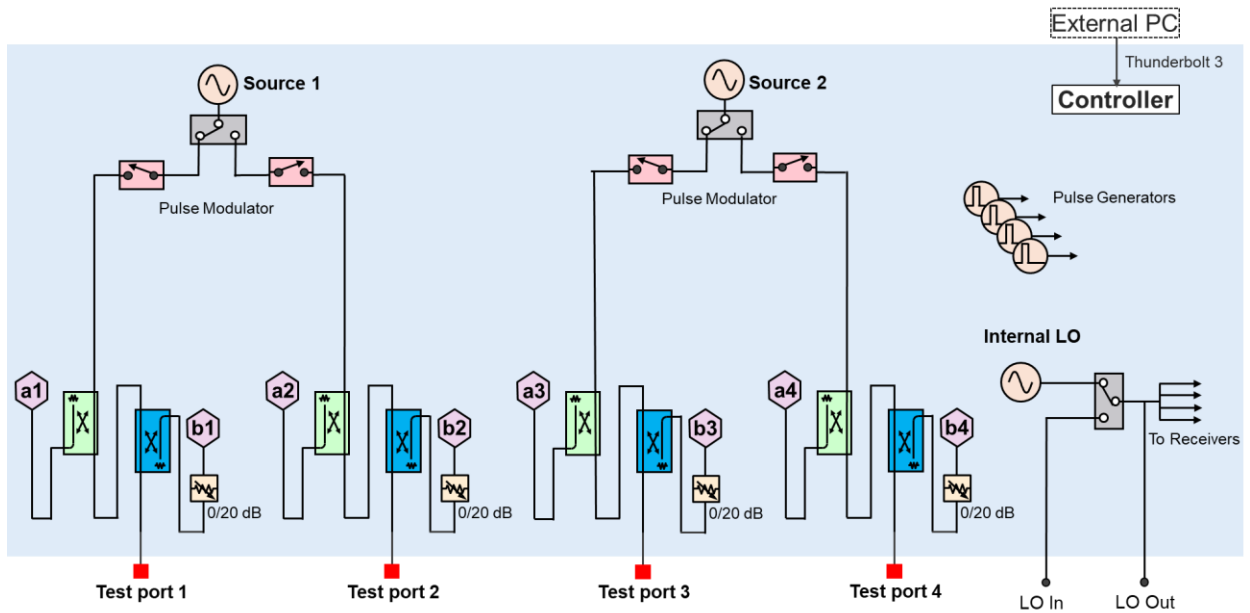

P502xB Option 600 (6-port base model)

