



TAOGLAS®



Datasheet

Warrior Band 28 Chip Antenna

Part No:
PA.500.A

Description

LTE/Cellular SMD Antenna
For 703-803MHz

Features:

703MHz to 803MHz
Designed for Band 28 IoT applications
Manufactured in an IATF16949 Certified Facility
Surface Mount Distribution
Dimensions: 40 x 5 x 6 mm
RoHS & REACH Compliant

1.	Introduction	2
2.	Specification	3
3.	Antenna Characteristics	4
4.	Radiation Patterns	7
5.	Mechanical Drawing	9
6.	Packaging	10
7.	Antenna Integration Guide	11
8.	Application Note (Different PCB length)	16
9.	Application Note (Antenna in different position)	19



1. Introduction

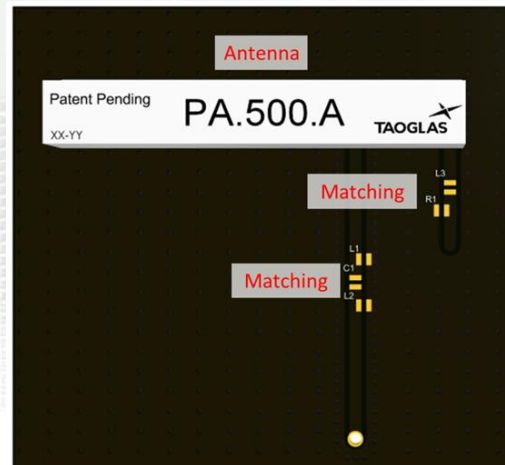

The Taoglas Warrior PA.500.A has been designed for use on cellular Band 28 for IoT device applications that utilize this band. The PA.500.A has strong performance at a difficult frequency – it is a specific band 28 antenna for IoT applications.

The PA.500 has been designed to have no clearance area to make integration easier for customers who may have difficulty integrating a different type of antenna which will not perform well at band 28.

In past years band 28 was for analogue TV transmission in Australia, New Zealand, and some Asia-Pacific areas. It is now the main Australian 4G band due to redefined spectrum usage.

Typical Applications include:

- Compact IoT Sensors
- Tablets and Smartphones
- Telematics and Tracking

For further information please contact your regional Taoglas customer support team.

2. Specification

Electrical	
Frequency (MHz)	B28
	703-803
Efficiency (%)	
B28	45.5
Average Gain (dB)	
B28	-3.5
Peak Gain (dBi)	
B28	-1.3
Impedance	50 Ω
Polarization	Linear
Radiation Pattern	Omni
Max. input power	5W

Mechanical	
Dimensions	40 x 5 x 6 mm
Material	Ceramic
EVB Connector	SMA (F)
Environmental	
Temperature Range	-40°C to 85°C
Moisture Sensitivity Level	3

3. Antenna Characteristics

3.1 Test Setup

AUT



Vector Network Analyzer

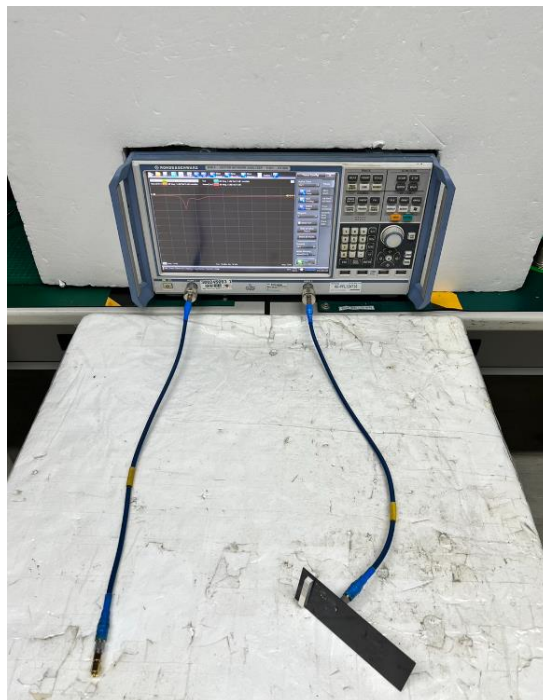

3.2 Return Loss

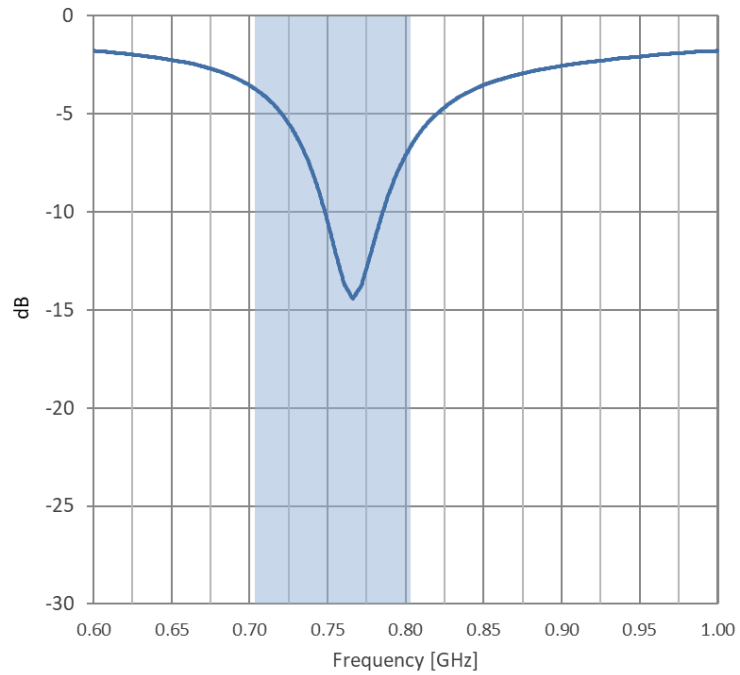

3.3 Efficiency

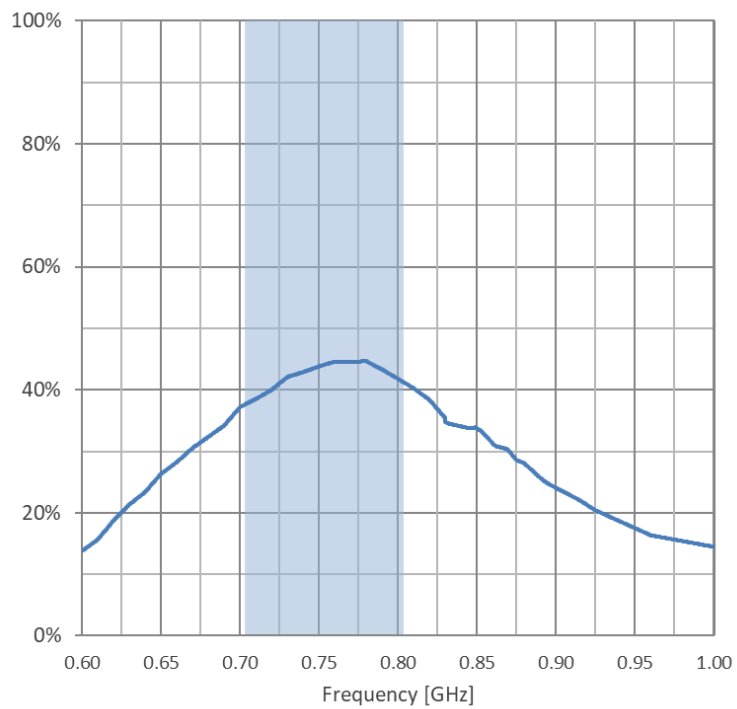

3.4 Average Gain

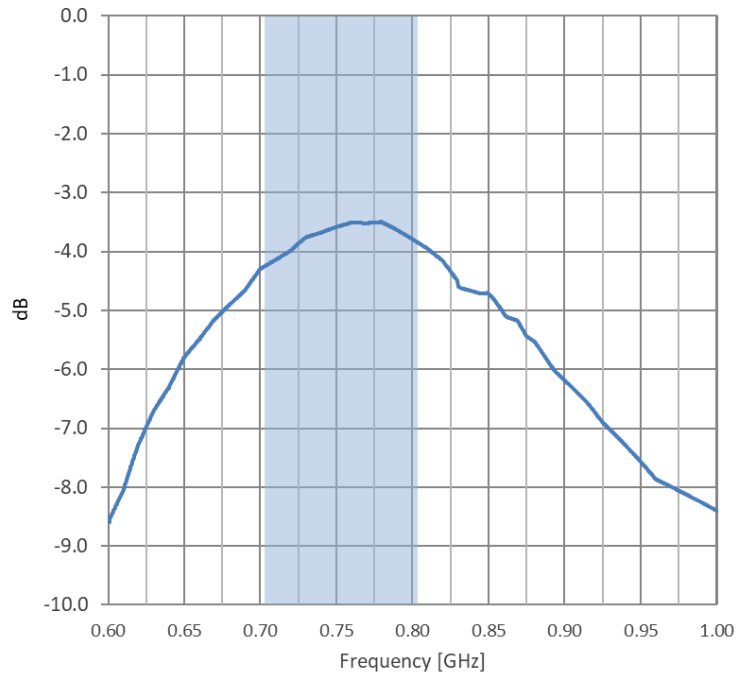

3.5 Peak Gain

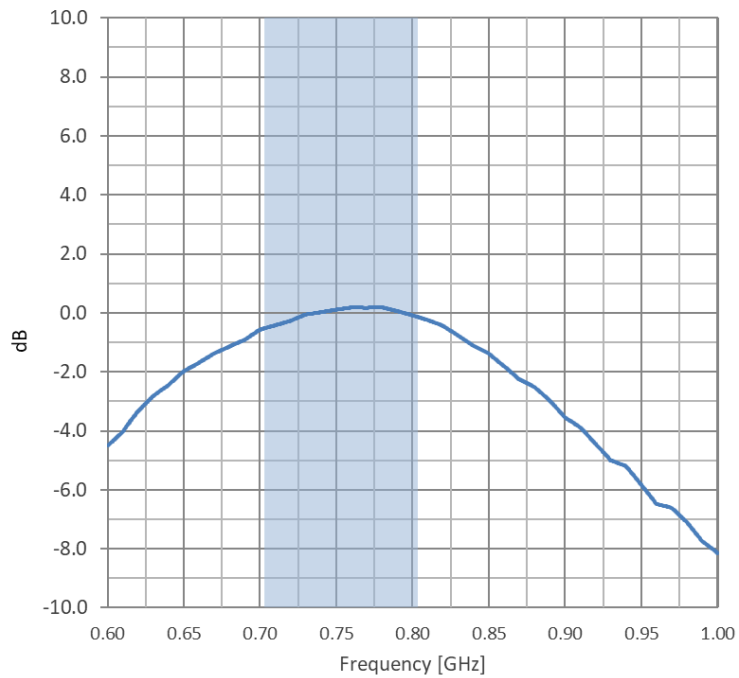

4. Radiation Patterns

4.1 Test Setup

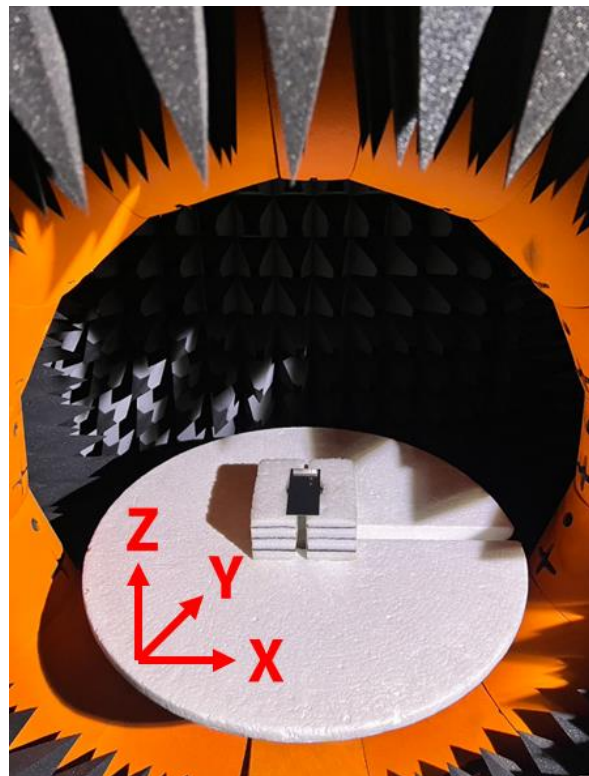
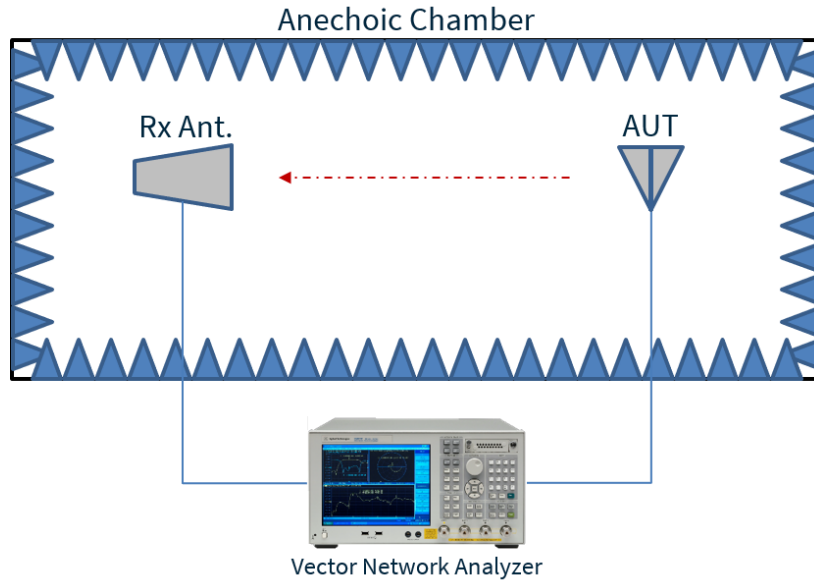

4.2 PA.500.A Patterns at 751 MHz

Gain total, 751MHz

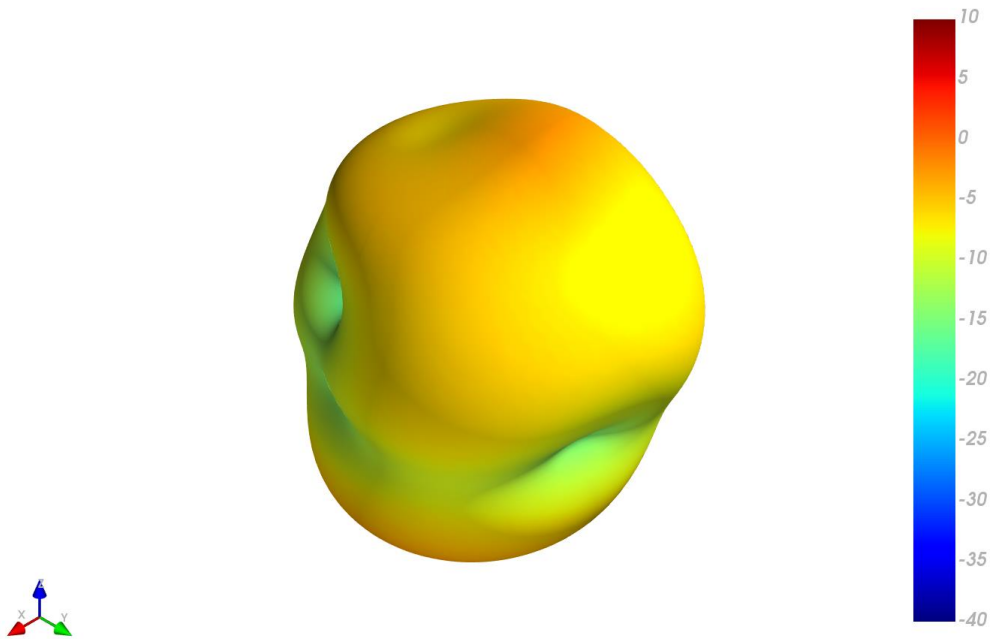

XZ Plane YZ Plane XY Plane

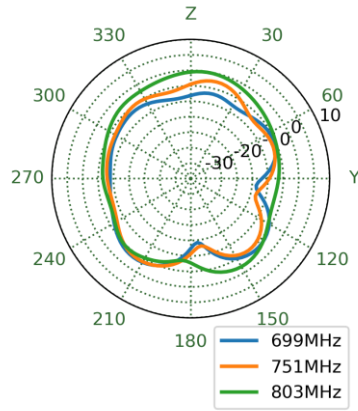
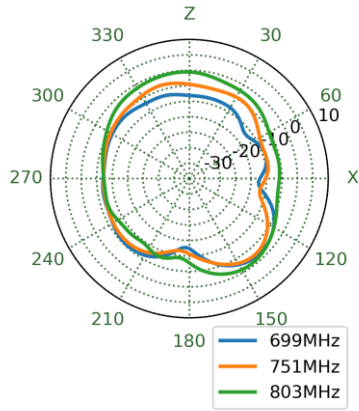
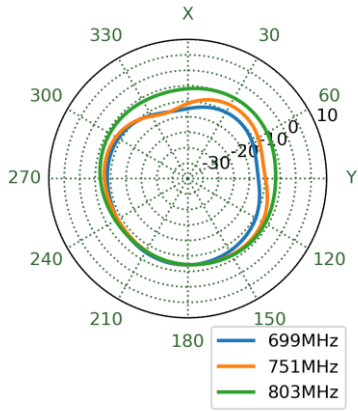

5. Mechanical Drawing

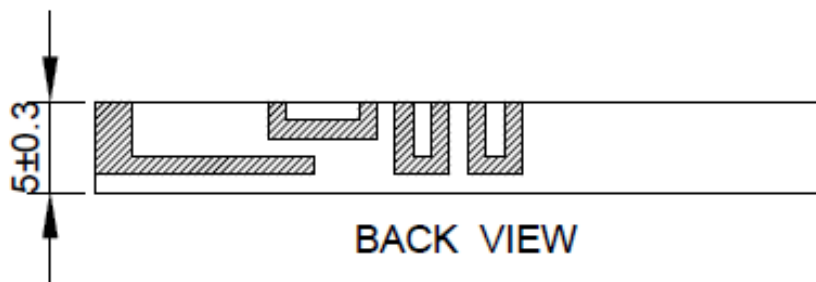
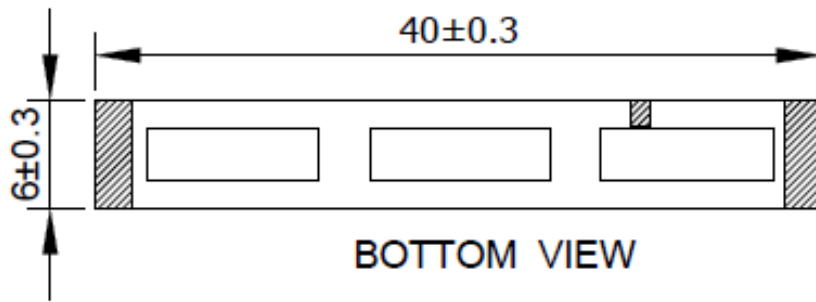

6. Packaging

Patent Pending
XX-YY

PA.500.A



- 450 PCS/ Reel
- SPQ Label



- 1 PCS / Vacuum bag
- 2 PCS / 3g Desiccant
- 1 PCS / Humidity test paper
- SPQ Label



- 1 PCS / Box
- Box(mm): 350x340x85
- Carton Label

7. Antenna Integration Guide

7.1 Schematic and Symbol Definition

The circuit symbol for the antenna is shown below. The antenna has 2 pins. (Pin 1: RF Feed and Pin 2: Ground)

Pin	Description
1	RF Feed
2	GND Feed
3	NC

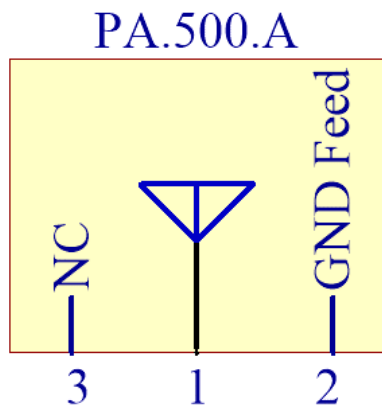

7.2 Antenna Integration

Whatever the size of the PCB, the antenna should ideally be placed on the PCB's shortest side, to take advantage of the ground plane. Optimized matching components can be placed as shown.

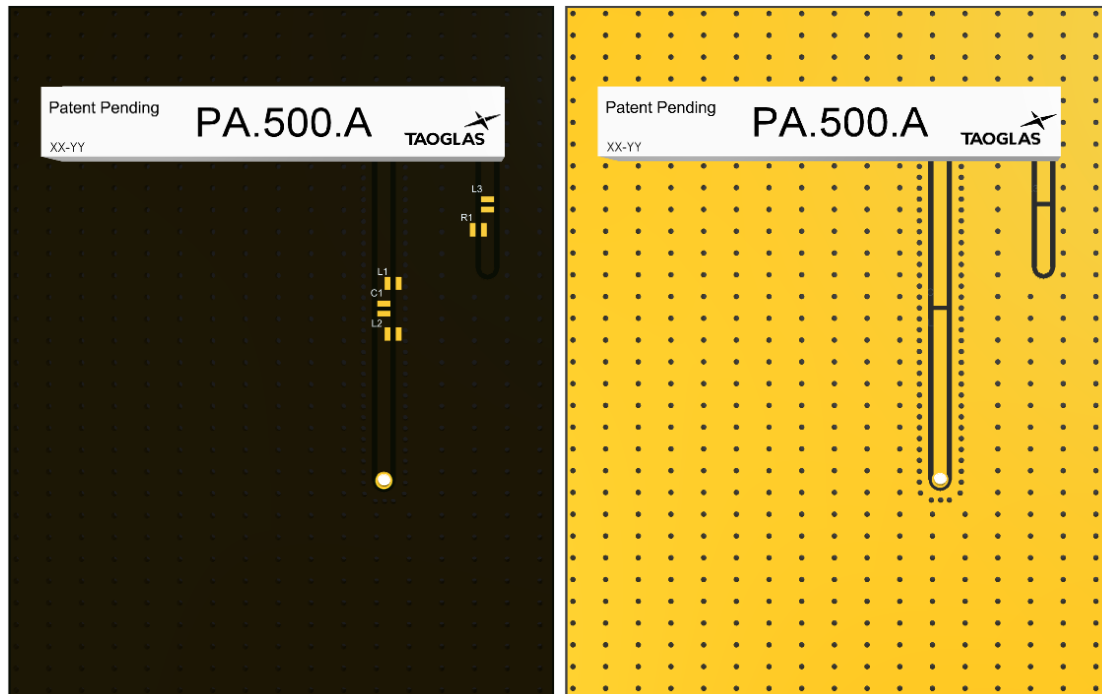

7.3 PCB Layout

The footprint on the PCB must meet the antenna specification. An example of the PCB layout shows the antenna footprint without clearance.

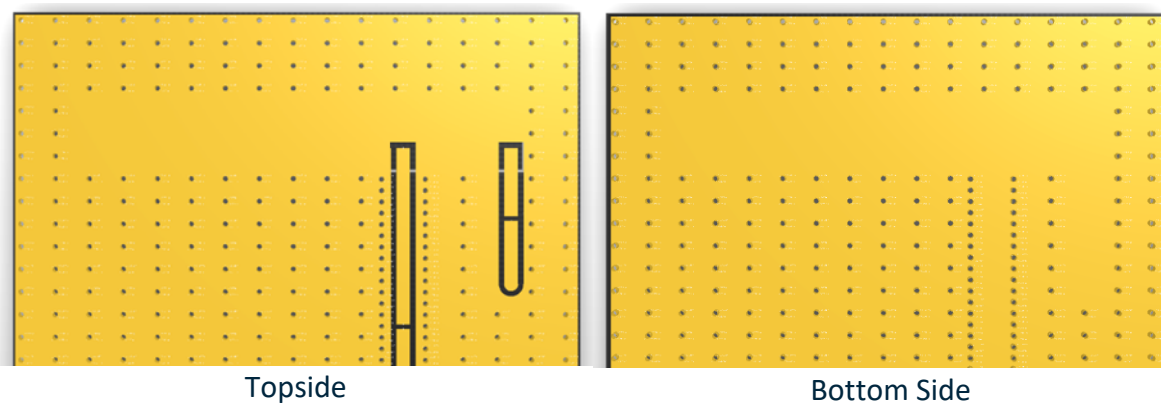

7.4 Evaluation Board

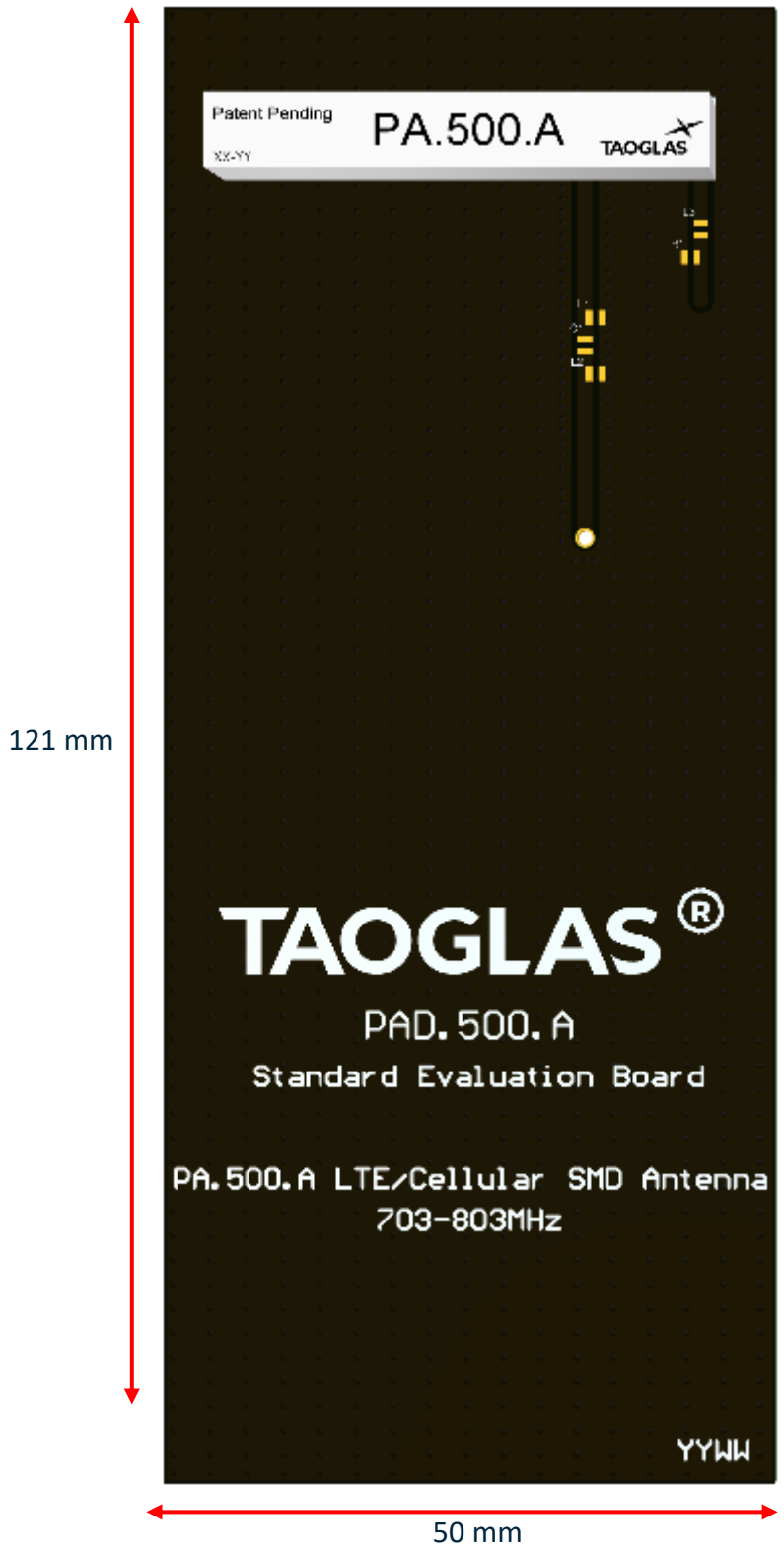

7.5 Evaluation Board Matching Circuit

The footprint on the PCB must meet the antenna specification. An example of the PCB layout shows the antenna footprint without clearance room.

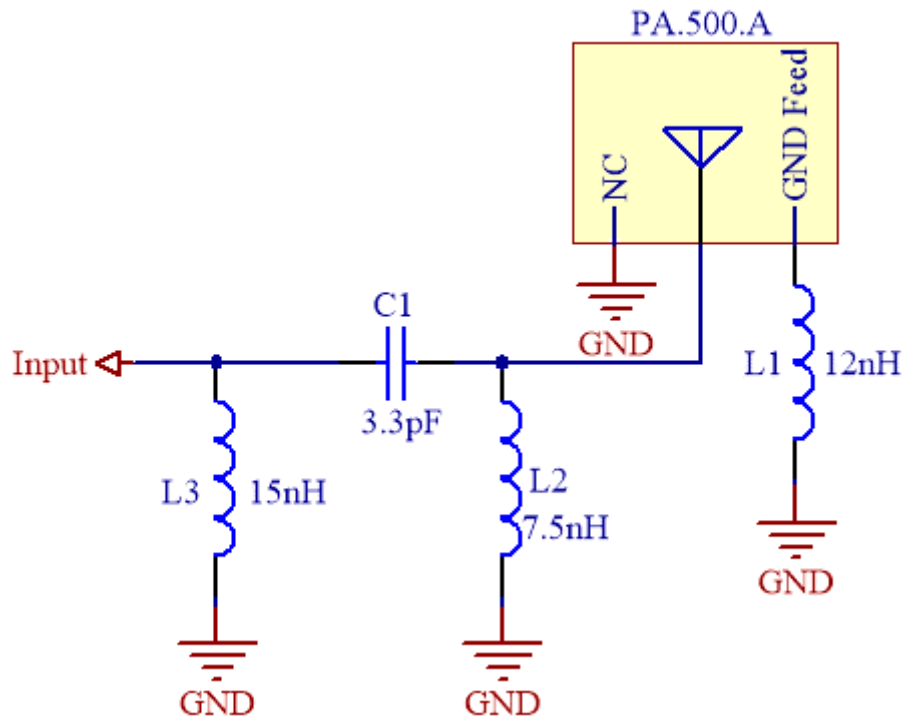

Designator	Type	Value
L1	Inductor	12 nH
L2	Inductor	7.5 nH
L3	Inductor	15 nH
C1	Capacitor	3.3 pF

7.6 Footprint

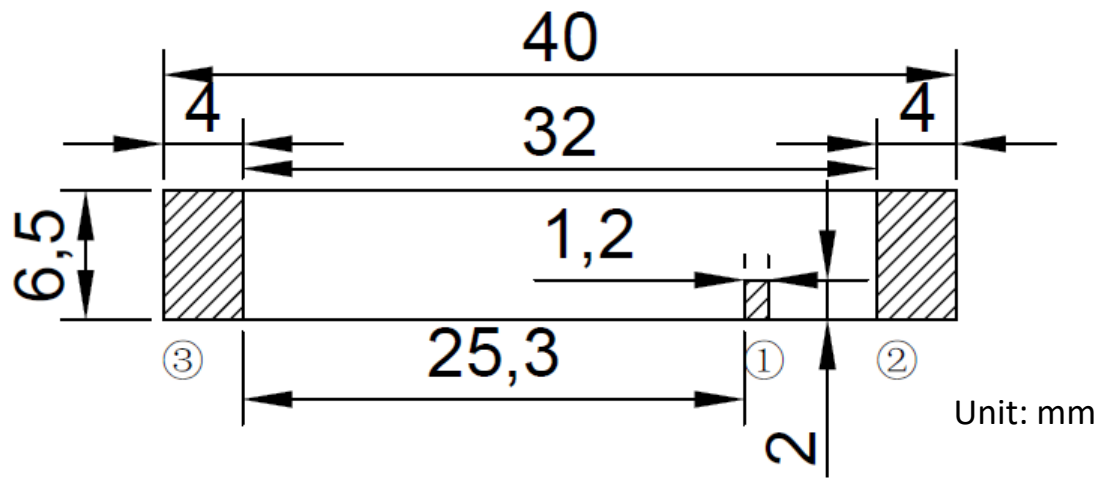

Pin	Description
1	RF Feed
2	GND Feed
3	NC

8. Application Note (Different PCB length)



8.1 Return Loss

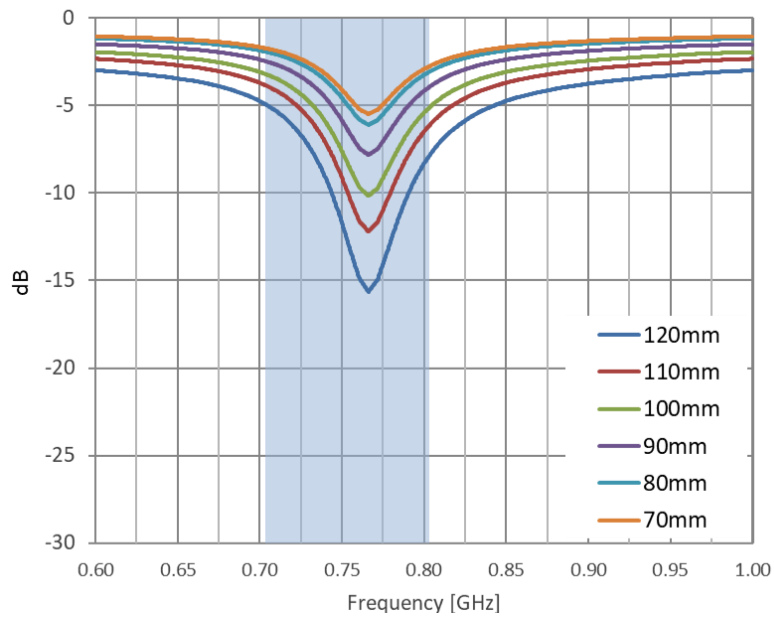

8.2 Efficiency

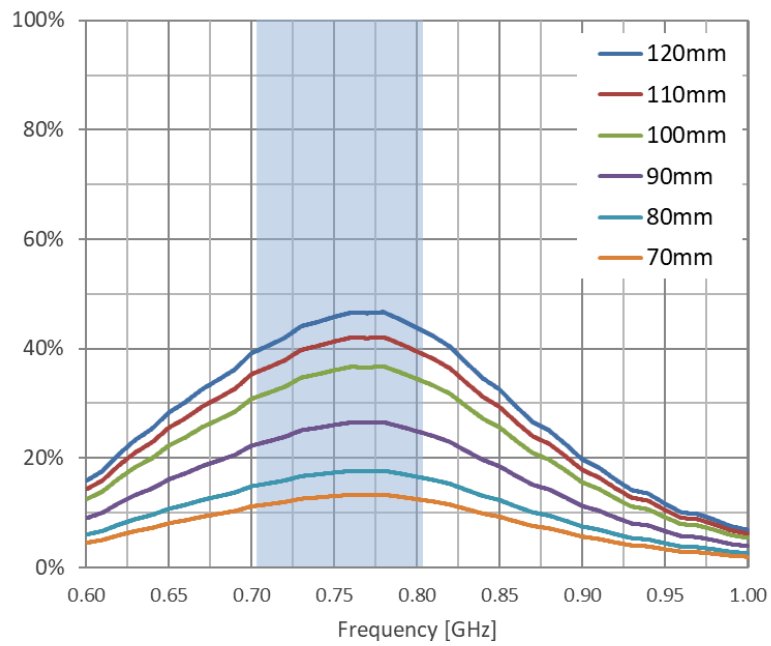

8.3 Average Gain

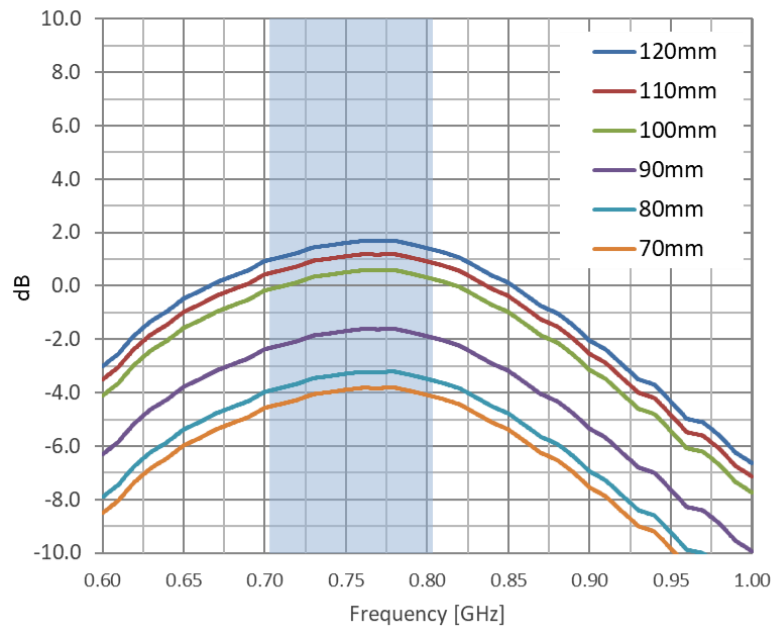

8.4 Peak Gain

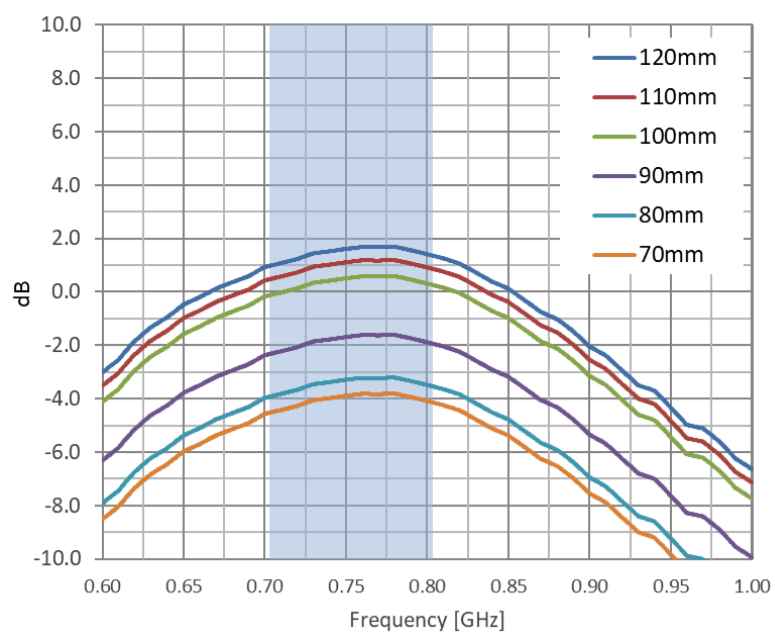

9. Application Note (Antenna in different position)

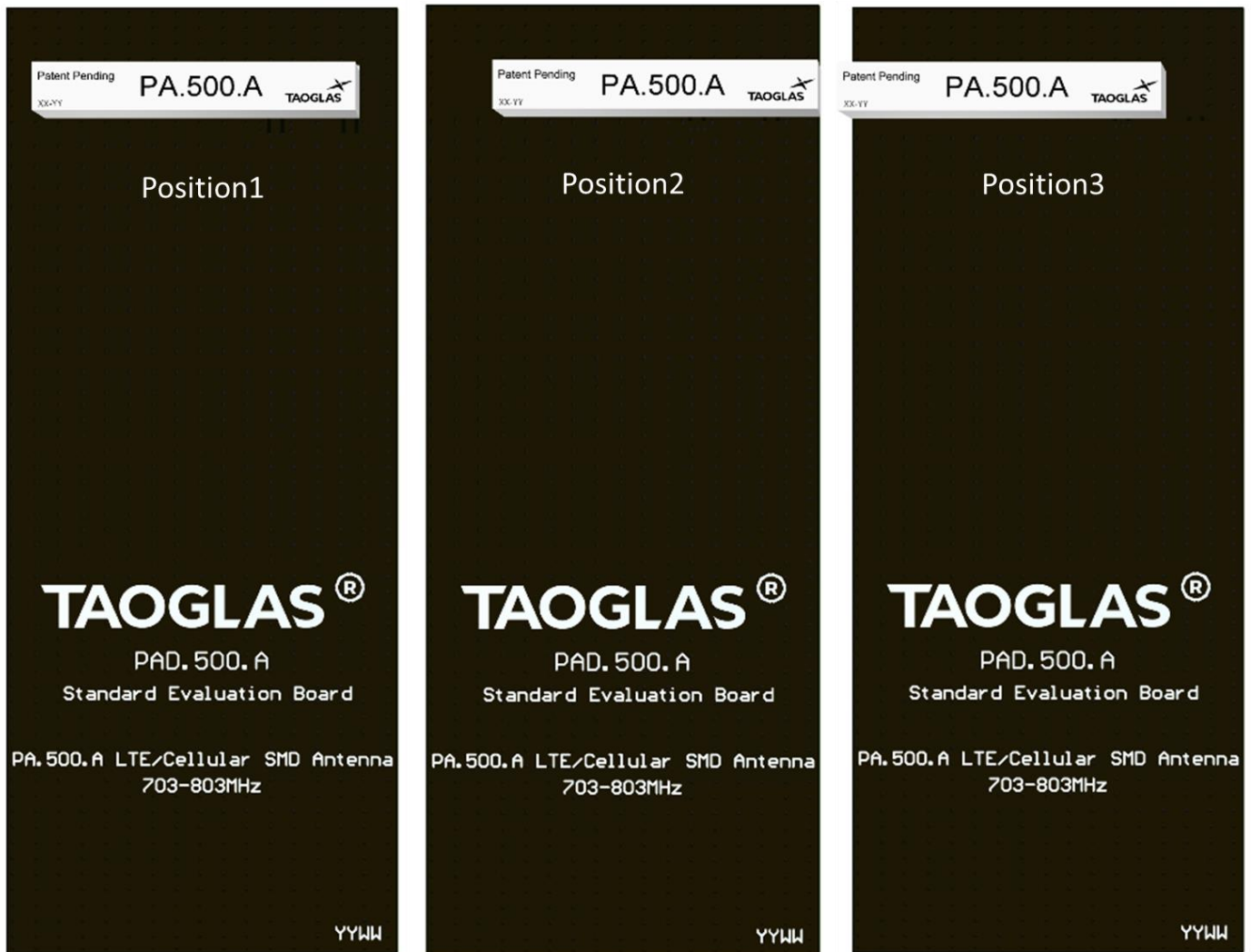

9.1 Return Loss

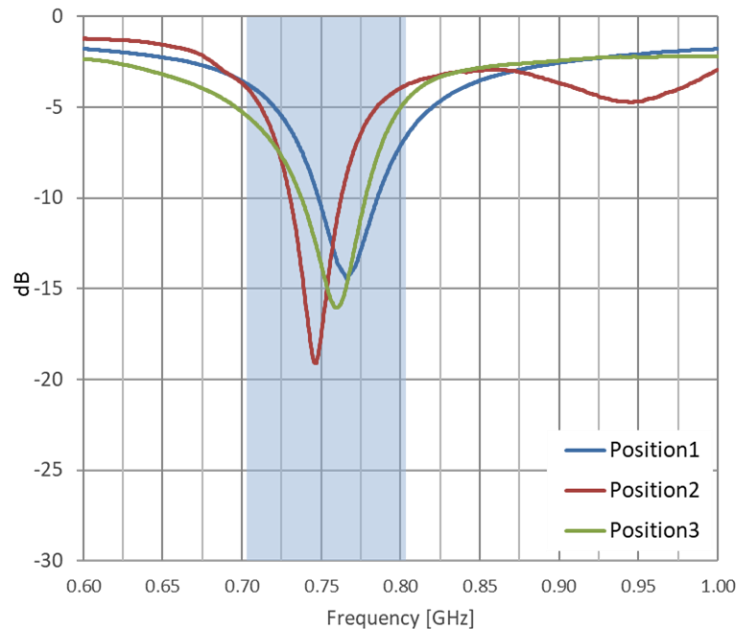

9.2 Efficiency

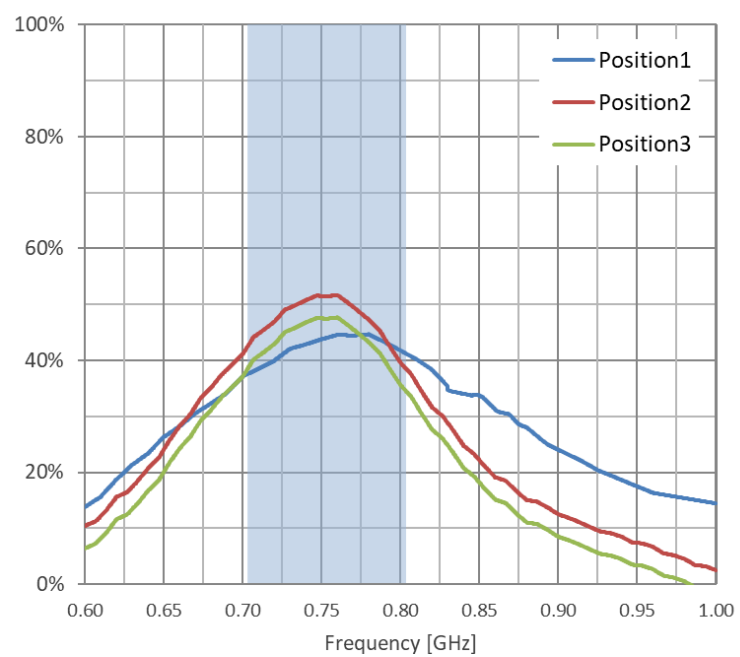

9.3 Average Gain

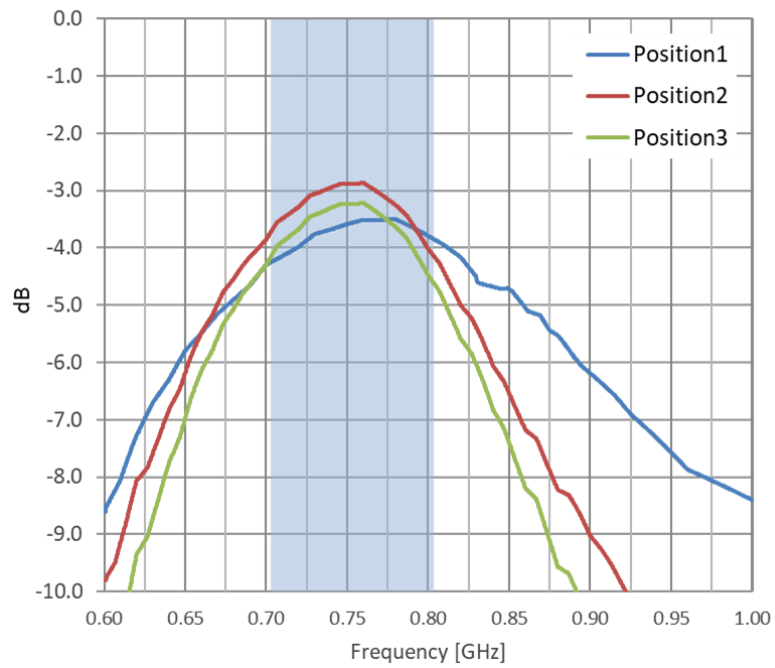

9.4 Peak Gain

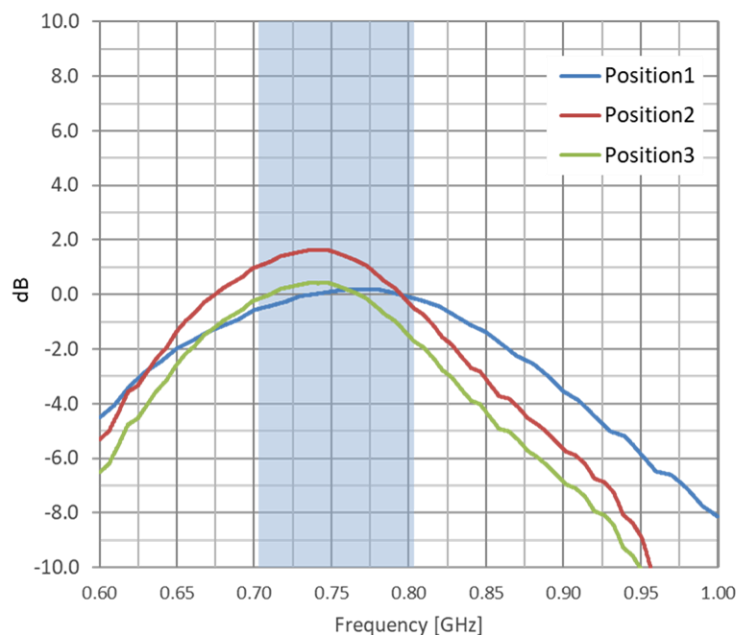

Changelog for the datasheet

SPE-23-8-182– PA.500.A

Revision: A (Initial Release)	
Date:	2023-06-19
Changes:	
Changes Made by:	Jack Conroy

Previous Revisions
