

# Push Button, Switch, Buzzer and LED Pilot Light

*Quick Selection Guide*



This quick selection guide is designed to help you quickly and accurately select all of the components needed to create a custom Push Button assembly, or to select the correct pilot device for an application. Simply determine which features are required, and find a part number that meets the requirement on the following pages. Many accessory items are available, for a truly custom fit.

## Push Button and Selector Switch Assembly

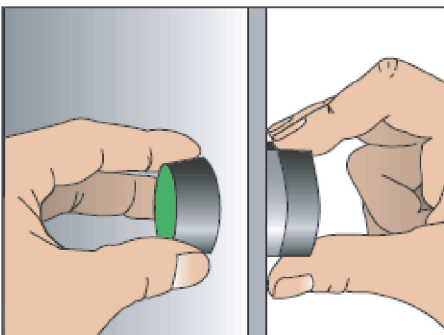
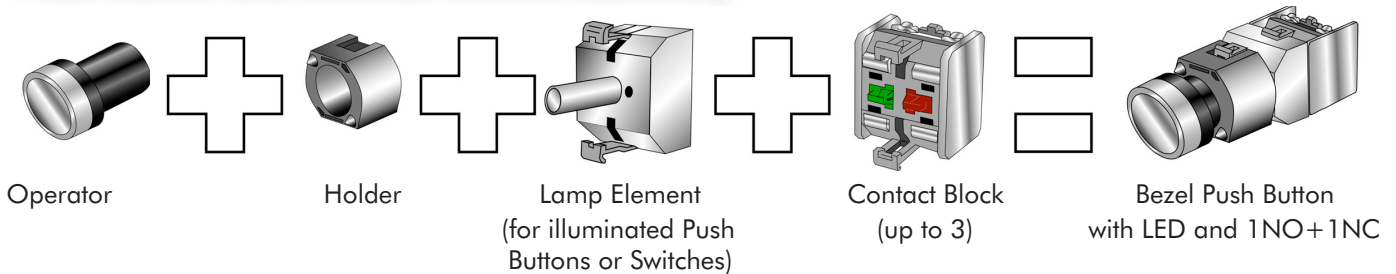

The operator will be inserted into the panel.

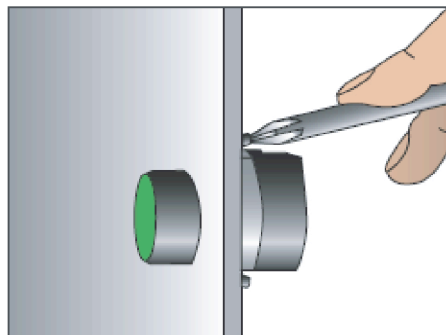

The holder will be secured at the back by two screws or nut.

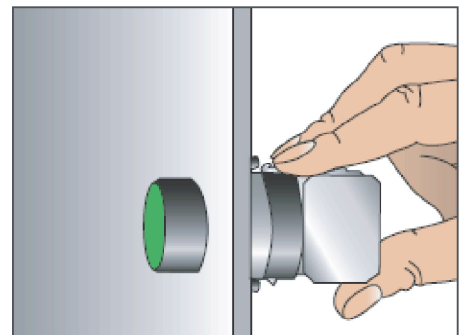

The contact block is snapped on.

## Pilot Light Assembly

Pilot lights and buzzers are simple to select and install. Simply determine the color, lens type, voltage, and find the correct part number - no other components are required.

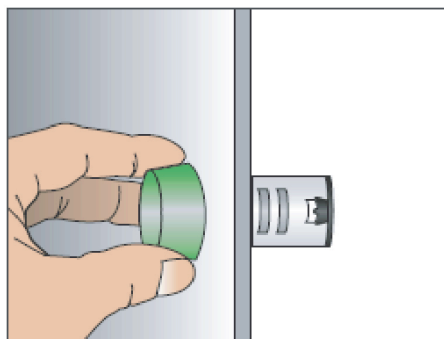

Just insert the pilot light in the the hole of the panel.

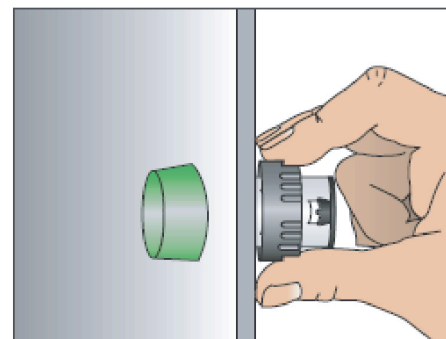

The pilot light will be secured at the back by the plastic nut.

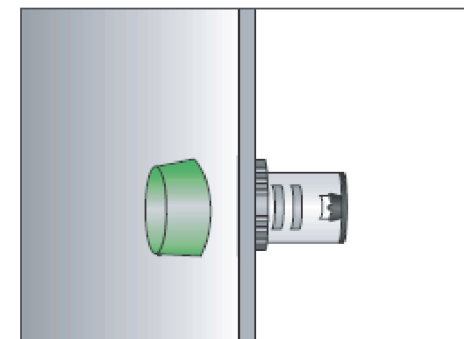

The pilot light has been installed.

**Push Button Operators - Illuminated**

Hole Size	Type	Mounting Ring	Action	Red	White	Black	Blue	Yellow	Green
22mm	Flush Round	Standard	Spring Return	PB22SIF0R	PB22SIF0W	PB22SIF0K	PB22SIF0B	PB22SIF0Y	PB22SIF0G
			Maintained	PB22SIF1R	PB22SIF1W	PB22SIF1K	PB22SIF1B	PB22SIF1Y	PB22SIF1G
		Bezel	Spring Return	PB22BIF0R	PB22BIF0W	PB22BIF0K	PB22BIF0B	PB22BIF0Y	PB22BIF0G
			Maintained	PB22BIF1R	PB22BIF1W	PB22BIF1K	PB22BIF1B	PB22BIF1Y	PB22BIF1G
	Extended	Standard	Spring Return	PB22SIE0R	PB22SIE0W	PB22SIE0K	PB22SIE0B	PB22SIE0Y	PB22SIE0G
			Maintained	PB22SIE1R	PB22SIE1W	PB22SIE1K	PB22SIE1B	PB22SIE1Y	PB22SIE1G
		Bezel	Spring Return	PB22BIE0R	PB22BIE0W	PB22BIE0K	PB22BIE0B	PB22BIE0Y	PB22BIE0G
			Maintained	PB22BIE1R	PB22BIE1W	PB22BIE1K	PB22BIE1B	PB22BIE1Y	PB22BIE1G
30mm	Flush Round	Flush	Spring Return	PB30FIF0R	PB30FIF0W	PB30FIF0K	PB30FIF0B	PB30FIF0Y	PB30FIF0G
			Maintained	PB30FIF1R	PB30FIF1W	PB30FIF1K	PB30FIF1B	PB30FIF1Y	PB30FIF1G
	Extended	Flush	Spring Return	PB30FIE0R	PB30FIE0W	PB30FIE0K	PB30FIE0B	PB30FIE0Y	PB30FIE0G
			Maintained	PB30FIE1R	PB30FIE1W	PB30FIE1K	PB30FIE1B	PB30FIE1Y	PB30FIE1G

**Push Button Operators - Non-Illuminated**

Hole Size	Type	Mounting Ring	Action	Red	White	Black	Blue	Yellow	Green
22mm	Flush Round	Standard	Spring Return	PB22SF0R	PB22SF0W	PB22SF0K	PB22SF0B	PB22SF0Y	PB22SF0G
			Maintained	PB22SF1R	PB22SF1W	PB22SF1K	PB22SF1B	PB22SF1Y	PB22SF1G
		Bezel	Spring Return	PB22BF0R	PB22BF0W	PB22BF0K	PB22BF0B	PB22BF0Y	PB22BF0G
			Maintained	PB22BF1R	PB22BF1W	PB22BF1K	PB22BF1B	PB22BF1Y	PB22BF1G
	Extended	Standard	Spring Return	PB22SE0R	PB22SE0W	PB22SE0K	PB22SE0B	PB22SE0Y	PB22SE0G
			Maintained	PB22SE1R	PB22SE1W	PB22SE1K	PB22SE1B	PB22SE1Y	PB22SE1G
		Bezel	Spring Return	PB22BE0R	PB22BE0W	PB22BE0K	PB22BE0B	PB22BE0Y	PB22BE0G
			Maintained	PB22BE1R	PB22BE1W	PB22BE1K	PB22BE1B	PB22BE1Y	PB22BE1G
30mm	Flush Round	Flush	Spring Return	PB30FF0R	PB30FF0W	PB30FF0K	PB30FF0B	PB30FF0Y	PB30FF0G
			Maintained	PB30FF1R	PB30FF1W	PB30FF1K	PB30FF1B	PB30FF1Y	PB30FF1G
	Extended	Flush	Spring Return	PB30FE0R	PB30FE0W	PB30FE0K	PB30FE0B	PB30FE0Y	PB30FE0G
			Maintained	PB30FE1R	PB30FE1W	PB30FE1K	PB30FE1B	PB30FE1Y	PB30FE1G

**Mushroom Push Button Operators - Illuminated**

Hole Size	Button Size	Mounting Ring	Action	Red	White	Black	Yellow	Green	
22mm	40mm	Standard	Spring Return	PB22SIM40R	PB22SIM40W	-	PB22SIM40Y	PB22SIM40G	
			Maintained	PB22SIM41R	PB22SIM41W	-	PB22SIM41Y	PB22SIM41G	
		Bezel	Spring Return	PB22BIM40R	PB22BIM40W	-	PB22BIM40Y	PB22BIM40G	
			Maintained	PB22BIM41R	PB22BIM41W	-	PB22BIM41Y	PB22BIM41G	
	60mm	Standard	Spring Return	PB22SIM60R	PB22SIM60W	-	PB22SIM60Y	PB22SIM60G	
			Maintained	PB22SIM61R	PB22SIM61W	-	PB22SIM61Y	PB22SIM61G	
30mm	40mm	Flush	Spring Return	PB30FIM40R	PB30FIM40W	-	PB30FIM40Y	PB30FIM40G	
			Maintained	PB30FIM41R	PB30FIM41W	-	PB30FIM41Y	PB30FIM41G	
		60mm	Flush	Spring Return	PB30FIM60R	PB30FIM60W	-	PB30FIM60Y	PB30FIM60G
				Maintained	PB30FIM61R	PB30FIM61W	-	PB30FIM61Y	PB30FIM61G

**Mushroom Push Button Operators - Non-Illuminated**

Hole Size	Button Size	Mounting Ring	Action	Red	White	Black	Yellow	Green	
22mm	40mm	Standard	Spring Return	PB22SM40R	-	PB22SM40K	PB22SM40Y	PB22SM40G	
			Maintained	PB22SM41R	-	PB22SM41K	PB22SM41Y	PB22SM41G	
		Bezel	Spring Return	PB22BM40R	-	PB22BM40K	PB22BM40Y	PB22BM40G	
			Maintained	PB22BM41R	-	PB22BM41K	PB22BM41Y	PB22BM41G	
	60mm	Standard	Spring Return	PB22SM60R	-	PB22SM60K	PB22SM60Y	PB22SM60G	
			Maintained	PB22SM61R	-	PB22SM61K	PB22SM61Y	PB22SM61G	
30mm	40mm	Flush	Spring Return	PB30FM40R	-	PB30FM40K	PB30FM40Y	PB30FM40G	
			Maintained	PB30FM41R	-	PB30FM41K	PB30FM41Y	PB30FM41G	
		60mm	Flush	Spring Return	PB30FM60R	-	PB30FM60K	PB30FM60Y	PB30FM60G
				Maintained	PB30FM61R	-	PB30FM61K	PB30FM61Y	PB30FM61G



**Emergency Stop Buttons - Non-Illuminated, Maintained Action**







Hole Size	Button Size	Mounting Ring	Reset	Red
22mm	40mm	Standard	Twist	PB22SEM41R
			Key	PB22SKM41R
	Bezel	Twist	PB22BEM41R	
		Key	PB22BKM41R	
60mm	Standard	Twist	PB22SEM61R	
	Bezel	Twist	PB22BEM61R	
30mm	40mm	Flush	Twist	PB30FEM41R
			Key	PB30FKM41R
60mm	Flush	Twist	PB30FEM61R	

**I/O Push Buttons**



Hole Size	Illuminated	
22mm	Yes	PB22SIO0RG
	No	PB22SIOL0RG























Selector Switches - Illuminated									
Hole Size	Handle Type	Mounting Ring	Action	Red	White	Black	Blue	Yellow	Green
22mm	Short	 Standard	2 Pos. L R	PB22SISRS21R	PB22SISRS21W	-	PB22SISRS21B	PB22SISRS21Y	PB22SISRS21G
			3 Pos. L C R	PB22SISRS31R	PB22SISRS31W	-	PB22SISRS31B	PB22SISRS31Y	PB22SISRS31G
		 Bezel	2 Pos. L R	PB22BISRS21R	PB22BISRS21W	-	PB22BISRS21B	PB22BISRS21Y	PB22BISRS21G
			3 Pos. L C R	PB22BISRS31R	PB22BISRS31W	-	PB22BISRS31B	PB22BISRS31Y	PB22BISRS31G
30mm	Short	 Flush	2 Pos. L R	PB30FISRS21R	PB30FISRS21W	-	PB30FISRS21B	PB30FISRS21Y	PB30FISRS21G
			3 Pos. L C R	PB30FISRS31R	PB30FISRS31W	-	PB30FISRS31B	PB30FISRS31Y	PB30FISRS31G

Selector Switches - Non-Illuminated									
Hole Size	Handle Type	Mounting Ring	Action	Red	White	Black	Blue	Yellow	Green
22mm	Short	 Standard	2 Pos. L R	PB22SSRS21R	-	PB22SSRS21K	-	PB22SSRS21Y	PB22SSRS21G
			2 Pos. L ↗ C	PB22SSRS22R	-	PB22SSRS22K	-	PB22SSRS22Y	PB22SSRS22G
			2 Pos. C ↖ R	PB22SSRS23R	-	PB22SSRS23K	-	PB22SSRS23Y	PB22SSRS23G
			3 Pos. L C R	PB22SSRS31R	-	PB22SSRS31K	-	PB22SSRS31Y	PB22SSRS31G
			3 Pos. L ↗ C ↖ R	PB22SSRS32R	-	PB22SSRS32K	-	PB22SSRS32Y	PB22SSRS32G
			3 Pos. L ↗ C R	PB22SSRS33R	-	PB22SSRS33K	-	PB22SSRS33Y	PB22SSRS33G
		 Bezel	3 Pos. L C ↖ R	PB22SSRS34R	-	PB22SSRS34K	-	PB22SSRS34Y	PB22SSRS34G
			2 Pos. L R	PB22BSRS21R	-	PB22BSRS21K	-	PB22BSRS21Y	PB22BSRS21G
			2 Pos. L ↗ C	PB22BSRS22R	-	PB22BSRS22K	-	PB22BSRS22Y	PB22BSRS22G
			2 Pos. C ↖ R	PB22BSRS23R	-	PB22BSRS23K	-	PB22BSRS23Y	PB22BSRS23G
			3 Pos. L C R	PB22BSRS31R	-	PB22BSRS31K	-	PB22BSRS31Y	PB22BSRS31G
			3 Pos. L ↗ C ↖ R	PB22BSRS32R	-	PB22BSRS32K	-	PB22BSRS32Y	PB22BSRS32G
	Long	 Standard	3 Pos. L ↗ C R	PB22BSRS33R	-	PB22BSRS33K	-	PB22BSRS33Y	PB22BSRS33G
			3 Pos. L C ↖ R	PB22BSRS34R	-	PB22BSRS34K	-	PB22BSRS34Y	PB22BSRS34G
			2 Pos. L R	PB22SLRS21R	-	PB22SLRS21K	-	PB22SLRS21Y	PB22SLRS21G
			2 Pos. L ↗ C	PB22SLRS22R	-	PB22SLRS22K	-	PB22SLRS22Y	PB22SLRS22G
			2 Pos. C ↖ R	PB22SLRS23R	-	PB22SLRS23K	-	PB22SLRS23Y	PB22SLRS23G
			3 Pos. L C R	PB22SLRS31R	-	PB22SLRS31K	-	PB22SLRS31Y	PB22SLRS31G
		 Bezel	3 Pos. L ↗ C ↖ R	PB22SLRS32R	-	PB22SLRS32K	-	PB22SLRS32Y	PB22SLRS32G
			3 Pos. L ↗ C R	PB22SLRS33R	-	PB22SLRS33K	-	PB22SLRS33Y	PB22SLRS33G
			3 Pos. L C ↖ R	PB22SLRS34R	-	PB22SLRS34K	-	PB22SLRS34Y	PB22SLRS34G
			2 Pos. L R	PB22BLRS21R	-	PB22BLRS21K	-	PB22BLRS21Y	PB22BLRS21G
			2 Pos. L ↗ C	PB22BLRS22R	-	PB22BLRS22K	-	PB22BLRS22Y	PB22BLRS22G
			2 Pos. C ↖ R	PB22BLRS23R	-	PB22BLRS23K	-	PB22BLRS23Y	PB22BLRS23G
30mm	Short	 Flush	3 Pos. L C R	PB22BLRS31R	-	PB22BLRS31K	-	PB22BLRS31Y	PB22BLRS31G
			3 Pos. L ↗ C ↖ R	PB22BLRS32R	-	PB22BLRS32K	-	PB22BLRS32Y	PB22BLRS32G
			3 Pos. L ↗ C R	PB22BLRS33R	-	PB22BLRS33K	-	PB22BLRS33Y	PB22BLRS33G
			3 Pos. L C ↖ R	PB22BLRS34R	-	PB22BLRS34K	-	PB22BLRS34Y	PB22BLRS34G
			2 Pos. L R	PB30FSRS21R	-	PB30FSRS21K	-	PB30FSRS21Y	PB30FSRS21G
			2 Pos. L ↗ C	PB30FSRS22R	-	PB30FSRS22K	-	PB30FSRS22Y	PB30FSRS22G
	Long	 Flush	2 Pos. C ↖ R	PB30FSRS23R	-	PB30FSRS23K	-	PB30FSRS23Y	PB30FSRS23G
			3 Pos. L C R	PB30FSRS31R	-	PB30FSRS31K	-	PB30FSRS31Y	PB30FSRS31G
			3 Pos. L ↗ C ↖ R	PB30FSRS32R	-	PB30FSRS32K	-	PB30FSRS32Y	PB30FSRS32G
			3 Pos. L ↗ C R	PB30FSRS33R	-	PB30FSRS33K	-	PB30FSRS33Y	PB30FSRS33G
			3 Pos. L C ↖ R	PB30FSRS34R	-	PB30FSRS34K	-	PB30FSRS34Y	PB30FSRS34G
			2 Pos. L R	PB30FLRS21R	-	PB30FLRS21K	-	PB30FLRS21Y	PB30FLRS21G
30mm	Long	 Flush	2 Pos. L ↗ C	PB30FLRS22R	-	PB30FLRS22K	-	PB30FLRS22Y	PB30FLRS22G
			2 Pos. C ↖ R	PB30FLRS23R	-	PB30FLRS23K	-	PB30FLRS23Y	PB30FLRS23G
			3 Pos. L C R	PB30FLRS31R	-	PB30FLRS31K	-	PB30FLRS31Y	PB30FLRS31G
			3 Pos. L ↗ C ↖ R	PB30FLRS32R	-	PB30FLRS32K	-	PB30FLRS32Y	PB30FLRS32G
			3 Pos. L ↗ C R	PB30FLRS33R	-	PB30FLRS33K	-	PB30FLRS33Y	PB30FLRS33G
			3 Pos. L C ↖ R	PB30FLRS34R	-	PB30FLRS34K	-	PB30FLRS34Y	PB30FLRS34G









(Note: Arrows indicate spring return function)

Key Selector Switches					
Hole Size	Mounting Ring	Action	Left Extract	Center Extract	Right Extract
22mm	 Standard	2 Pos. L R	PB22SKRS21KL	-	PB22SKRS21KR
		3 Pos. L C R	PB22SKRS31KL	PB22SKRS31KC	PB22SKRS31KR
30mm	 Flush	2 Pos. L R	PB30FKRS21	-	PB30FKRS21
		3 Pos. L C R	PB30FKRS31	PB30FKRS31	PB30FKRS31

(Note: PB30F types allow key to be extracted from any position)

Contact Blocks			Holders		
Configuration	 Snap Action	 Slow Action		Metal	PBMBM
2 NO (DPST)	PA2200/1	PA2200/2		Plastic	PBMBP
2 NC (DPST)	PA2020/1	PA2020/2		Nut	PBMBN
1 NC (SPST)	PA2010/1	PA2010/2			
1 NO (SPST)	PA2100/1	PA2100/2			
1 NC + 1 NO (DPST)	PA2110/1	PA2110/2			
Lamp Elements					
Voltage	 Red	 White	Blue	Yellow	Green
6 VAC/DC	PALAMPR06	PALAMPW06	PALAMPB06	PALAMPY06	PALAMPG06
12 VAC/DC	PALAMPR12	PALAMPW12	PALAMPB12	PALAMPY12	PALAMPG12
24 VAC/DC	PALAMPR24	PALAMPW24	PALAMPB24	PALAMPY24	PALAMPG24
48 VAC/DC	PALAMPR48	PALAMPW48	PALAMPB48	PALAMPY48	PALAMPG48
110 VAC/DC	PALAMPR110	PALAMPW110	PALAMPB110	PALAMPY110	PALAMPG110
220 VDC	PALAMPR220D	PALAMPW220D	PALAMPB220D	PALAMPY220D	PALAMPG220D
220 VAC	PALAMPR220A	PALAMPW220A	PALAMPB220A	PALAMPY220A	PALAMPG220A
380 VAC	PALAMPR380A	PALAMPW380A	PALAMPB380A	PALAMPY380A	PALAMPG380A
Accessories for Push Buttons					
Picture	Accessories for Push Buttons			Part Number	
	Seal Cover for IP67 Rating			PASEALCOV	
	Shield for preventing accidental hit			PAPBSHIELD	
	Protection cover - lockable			PAPBCOV	
	Terminal shield - protect against electrical shock			PA2SHIELD	
	Mounting ring - 22mm hole			PAMR22	
	Mounting ring - 25mm hole			PAMR25	
	Front bezel set - 30mm hole			PAFBZL30	
	Label frame for adding description - 10mm			PALBF11	
	Label frame for adding description - 18mm			PALBF18	
	Emergency Stop plate - 60mm diameter			PAWP6	
	Emergency Stop plate - 90mm diameter			PAWP9	
	Yellow Protection Ring for preventing accidental hit - 60mm			PAYPR4	
	Yellow Protection Ring for preventing accidental hit - 40mm			PAYPR6	
	Panel hole cap for unused 22mm holes			PAPHC22	

Pilot Lights

Size	Type	Voltage	Red	White	Blue	Yellow	Green		
22mm Standard (50mm behind panel depth)	 High Lens	6 VAC/DC	PL22SHLR06	PL22SHLW06	PL22SHLB06	PL22SHLY06	PL22SHLG06		
		12 VAC/DC	PL22SHLR12	PL22SHLW12	PL22SHLB12	PL22SHLY12	PL22SHLG12		
		24 VAC/DC	PL22SHLR24	PL22SHLW24	PL22SHLB24	PL22SHLY24	PL22SHLG24		
		48 VAC/DC	PL22SHLR48	PL22SHLW48	PL22SHLB48	PL22SHLY48	PL22SHLG48		
		110 VAC/DC	PL22SHLR110	PL22SHLW110	PL22SHLB110	PL22SHLY110	PL22SHLG110		
		220 VDC	PL22SHLR220D	PL22SHLW220D	PL22SHLB220D	PL22SHLY220D	PL22SHLG220D		
		220 VAC	PL22SHLR220A	PL22SHLW220A	PL22SHLB220A	PL22SHLY220A	PL22SHLG220A		
		380 VAC	PL22SHLR380A	PL22SHLW380A	PL22SHLB380A	PL22SHLY380A	PL22SHLG380A		
		 Concentric Lens	6 VAC/DC	PL22SRLR06	PL22SRLW06	PL22SRLB06	PL22SRLY06	PL22SRLG06	
			12 VAC/DC	PL22SRLR12	PL22SRLW12	PL22SRLB12	PL22SRLY12	PL22SRLG12	
			24 VAC/DC	PL22SRLR24	PL22SRLW24	PL22SRLB24	PL22SRLY24	PL22SRLG24	
			48 VAC/DC	PL22SRLR48	PL22SRLW48	PL22SRLB48	PL22SRLY48	PL22SRLG48	
	110 VAC/DC		PL22SRLR110	PL22SRLW110	PL22SRLB110	PL22SRLY110	PL22SRLG110		
	220 VDC		PL22SRLR220D	PL22SRLW220D	PL22SRLB220D	PL22SRLY220D	PL22SRLG220D		
	220 VAC		PL22SRLR220A	PL22SRLW220A	PL22SRLB220A	PL22SRLY220A	PL22SRLG220A		
	380 VAC		PL22SRLR380A	PL22SRLW380A	PL22SRLB380A	PL22SRLY380A	PL22SRLG380A		
	 Low Lens		6 VAC/DC	PL22SLLR06	PL22SLLW06	PL22SLLB06	PL22SLLY06	PL22SLLG06	
			12 VAC/DC	PL22SLLR12	PL22SLLW12	PL22SLLB12	PL22SLLY12	PL22SLLG12	
			24 VAC/DC	PL22SLLR24	PL22SLLW24	PL22SLLB24	PL22SLLY24	PL22SLLG24	
			48 VAC/DC	PL22SLLR48	PL22SLLW48	PL22SLLB48	PL22SLLY48	PL22SLLG48	
		110 VAC/DC	PL22SLLR110	PL22SLLW110	PL22SLLB110	PL22SLLY110	PL22SLLG110		
		220 VDC	PL22SLLR220D	PL22SLLW220D	PL22SLLB220D	PL22SLLY220D	PL22SLLG220D		
		220 VAC	PL22SLLR220A	PL22SLLW220A	PL22SLLB220A	PL22SLLY220A	PL22SLLG220A		
		380 VAC	PL22SLLR380A	PL22SLLW380A	PL22SLLB380A	PL22SLLY380A	PL22SLLG380A		
		 Teeth Lens	6 VAC/DC	PL22STLR06	PL22STLW06	PL22STLB06	PL22STLY06	PL22STLG06	
			12 VAC/DC	PL22STLR12	PL22STLW12	PL22STLB12	PL22STLY12	PL22STLG12	
			24 VAC/DC	PL22STLR24	PL22STLW24	PL22STLB24	PL22STLY24	PL22STLG24	
			48 VAC/DC	PL22STLR48	PL22STLW48	PL22STLB48	PL22STLY48	PL22STLG48	
	110 VAC/DC		PL22STLR110	PL22STLW110	PL22STLB110	PL22STLY110	PL22STLG110		
	220 VDC		PL22STLR220D	PL22STLW220D	PL22STLB220D	PL22STLY220D	PL22STLG220D		
	220 VAC		PL22STLR220A	PL22STLW220A	PL22STLB220A	PL22STLY220A	PL22STLG220A		
	380 VAC		PL22STLR380A	PL22STLW380A	PL22STLB380A	PL22STLY380A	PL22STLG380A		
	 Flashing Light		6 VAC/DC	PL22SFLR06	PL22SFLW06	PL22SFLB06	PL22SFLY06	PL22SFLG06	
			12 VAC/DC	PL22SFLR12	PL22SFLW12	PL22SFLB12	PL22SFLY12	PL22SFLG12	
			24 VAC/DC	PL22SFLR24	PL22SFLW24	PL22SFLB24	PL22SFLY24	PL22SFLG24	
			48 VAC/DC	PL22SFLR48	PL22SFLW48	PL22SFLB48	PL22SFLY48	PL22SFLG48	
		110 VAC/DC	PL22SFLR110	PL22SFLW110	PL22SFLB110	PL22SFLY110	PL22SFLG110		
		220 VDC	PL22SFLR220D	PL22SFLW220D	PL22SFLB220D	PL22SFLY220D	PL22SFLG220D		
		220 VAC	PL22SFLR220A	PL22SFLW220A	PL22SFLB220A	PL22SFLY220A	PL22SFLG220A		
		380 VAC	PL22SFLR380A	PL22SFLW380A	PL22SFLB380A	PL22SFLY380A	PL22SFLG380A		
		22mm Compact (39mm behind panel depth)	 High Lens	6 VAC/DC	PL22CHLR06	PL22CHLW06	PL22CHLB06	PL22CHLY06	PL22CHLG06
				12 VAC/DC	PL22CHLR12	PL22CHLW12	PL22CHLB12	PL22CHLY12	PL22CHLG12
				24 VAC/DC	PL22CHLR24	PL22CHLW24	PL22CHLB24	PL22CHLY24	PL22CHLG24
				48 VAC/DC	PL22CHLR48	PL22CHLW48	PL22CHLB48	PL22CHLY48	PL22CHLG48
	110 VAC/DC			PL22CHLR110	PL22CHLW110	PL22CHLB110	PL22CHLY110	PL22CHLG110	
	220 VDC			PL22CHLR220D	PL22CHLW220D	PL22CHLB220D	PL22CHLY220D	PL22CHLG220D	
	220 VAC			PL22CHLR220A	PL22CHLW220A	PL22CHLB220A	PL22CHLY220A	PL22CHLG220A	
	380 VAC			PL22CHLR380A	PL22CHLW380A	PL22CHLB380A	PL22CHLY380A	PL22CHLG380A	
 Concentric Lens	6 VAC/DC			PL22CRLR06	PL22CRLW06	PL22CRLB06	PL22CRLY06	PL22CRLG06	
	12 VAC/DC			PL22CRLR12	PL22CRLW12	PL22CRLB12	PL22CRLY12	PL22CRLG12	
	24 VAC/DC			PL22CRLR24	PL22CRLW24	PL22CRLB24	PL22CRLY24	PL22CRLG24	
	48 VAC/DC			PL22CRLR48	PL22CRLW48	PL22CRLB48	PL22CRLY48	PL22CRLG48	
	110 VAC/DC		PL22CRLR110	PL22CRLW110	PL22CRLB110	PL22CRLY110	PL22CRLG110		
	220 VDC		PL22CRLR220D	PL22CRLW220D	PL22CRLB220D	PL22CRLY220D	PL22CRLG220D		
	220 VAC		PL22CRLR220A	PL22CRLW220A	PL22CRLB220A	PL22CRLY220A	PL22CRLG220A		
	380 VAC		PL22CRLR380A	PL22CRLW380A	PL22CRLB380A	PL22CRLY380A	PL22CRLG380A		
	 Low Lens		6 VAC/DC	PL22CLLR06	PL22CLLW06	PL22CLLB06	PL22CLLY06	PL22CLLG06	
			12 VAC/DC	PL22CLLR12	PL22CLLW12	PL22CLLB12	PL22CLLY12	PL22CLLG12	
			24 VAC/DC	PL22CLLR24	PL22CLLW24	PL22CLLB24	PL22CLLY24	PL22CLLG24	
			48 VAC/DC	PL22CLLR48	PL22CLLW48	PL22CLLB48	PL22CLLY48	PL22CLLG48	
110 VAC/DC			PL22CLLR110	PL22CLLW110	PL22CLLB110	PL22CLLY110	PL22CLLG110		
220 VDC			PL22CLLR220D	PL22CLLW220D	PL22CLLB220D	PL22CLLY220D	PL22CLLG220D		
220 VAC			PL22CLLR220A	PL22CLLW220A	PL22CLLB220A	PL22CLLY220A	PL22CLLG220A		
380 VAC			PL22CLLR380A	PL22CLLW380A	PL22CLLB380A	PL22CLLY380A	PL22CLLG380A		
 Teeth Lens		6 VAC/DC	PL22CTLR06	PL22CTLW06	PL22CTLB06	PL22CTLY06	PL22CTLG06		
		12 VAC/DC	PL22CTLR12	PL22CTLW12	PL22CTLB12	PL22CTLY12	PL22CTLG12		
		24 VAC/DC	PL22CTLR24	PL22CTLW24	PL22CTLB24	PL22CTLY24	PL22CTLG24		
		48 VAC/DC	PL22CTLR48	PL22CTLW48	PL22CTLB48	PL22CTLY48	PL22CTLG48		
	110 VAC/DC	PL22CTLR110	PL22CTLW110	PL22CTLB110	PL22CTLY110	PL22CTLG110			
	220 VDC	PL22CTLR220D	PL22CTLW220D	PL22CTLB220D	PL22CTLY220D	PL22CTLG220D			
	220 VAC	PL22CTLR220A	PL22CTLW220A	PL22CTLB220A	PL22CTLY220A	PL22CTLG220A			
	380 VAC	PL22CTLR380A	PL22CTLW380A	PL22CTLB380A	PL22CTLY380A	PL22CTLG380A			