

# UM11710

## PCAL6408A-ARD evaluation board

Rev. 1.0 — 1 December 2021

User manual

### Document information

Information	Content
Keywords	PCAL6408A, I <sup>2</sup> C-bus, 8-bit I/O bus, Arduino port, EVK
Abstract	The PCAL6408A-ARD evaluation board is a daughter card equipped with Arduino port, designated for easy test and design of PCAL6408A IC, 8-bit port expander, controlled through FM I <sup>2</sup> C 2-wire bus, with RESET. The board is fully compliant with IMXRT1050 EVK, LPCXpresso55S69 (LPC55S69-ECK) and i.MX 8M Mini LPDDR4 EVK (8MMINILPD4-EVK, 8MMINID4-EVK), including GUI software control. The board can be attached to any device equipped with Arduino port.



Table 1. Revision history

Rev	Date	Description
1.0	20211201	Initial version

**IMPORTANT NOTICE****For engineering development or evaluation purposes only**

NXP provides the product under the following conditions:

This evaluation kit is for use of **ENGINEERING DEVELOPMENT OR EVALUATION PURPOSES ONLY**. It is provided as a sample IC pre-soldered to a printed-circuit board to make it easier to access inputs, outputs and supply terminals. This evaluation board may be used with any development system or other source of I/O signals by connecting it to the host MCU computer board via off-the-shelf cables. This evaluation board is not a Reference Design and is not intended to represent a final design recommendation for any particular application. Final device in an application heavily depends on proper printed-circuit board layout and heat sinking design as well as attention to supply filtering, transient suppression, and I/O signal quality.

The product provided may not be complete in terms of required design, marketing, and or manufacturing related protective considerations, including product safety measures typically found in the end device incorporating the product. Due to the open construction of the product, it is the responsibility of the user to take all appropriate precautions for electric discharge. In order to minimize risks associated with the customers' applications, adequate design and operating safeguards must be provided by the customer to minimize inherent or procedural hazards. For any safety concerns, contact NXP sales and technical support services.

## 1 Introduction

---

This document describes the PCAL6408A-ARD evaluation board. The evaluation board is built around the PCAL6408A, low-voltage translating, 8-bit I<sup>2</sup>C-bus/SMBus I/O expander with interrupt output, reset, and configuration registers, produced by NXP Semiconductors. The evaluation board serves as a daughter card that can be connected through an Arduino port to various Arduino compatible (including original Arduino Uno R3) EVK / mother boards for the purpose of testing and measuring the characteristics of the PCAL6408A Device Under Test (DUT).

The PCAL6408A-ARD daughter card communicates through the Arduino port with the host device via the Fast-mode I<sup>2</sup>C-bus. Alongside the I<sup>2</sup>C bus, three additional digital lines allows the mother board to control the DUT through the same Arduino port.

Power is delivered from the mother board (EVK) through the Arduino port also.

The board contains four on-boards LEDs and four switches, connected to the I/O pins of the DUT. The same I/O bus is shared with a connector for external access to the I/O pins.

Additionally, a Graphical User Interface (Windows platform) is provided to facilitate the evaluation of the daughter board. The GUI is used with the following NXP evaluation boards: IMXRT1050 EVK Board, LPCXpresso55S69 Development Board and i.MX 8M Mini LPDDR4 EVK Board.

## 2 Finding kit resources and information on the NXP web site

---

NXP Semiconductors provides online resources for evaluation board and its supported device(s) on <http://www.nxp.com>.

The information page for PCAL6408A-ARD evaluation board is at <http://www.nxp.com/PCAL6408A-ARD>. The information page provides overview information, documentation, software and tools, parametrics, ordering information and a **Getting Started** tab. The Getting Started tab provides quick-reference information applicable to using the PCAL6408A-ARD evaluation board, including the downloadable assets referenced in this document.

### 2.1 Collaborate in the NXP community

The NXP community is for sharing ideas and tips, ask and answer technical questions, and receive input on just about any embedded design topic.

The NXP community is at <http://community.nxp.com>.

## 3 Getting ready

---

Working with the PCAL6408A-ARD requires the kit contents, additional hardware, and a Windows PC workstation with installed software.

### 3.1 Kit contents

- Assembled and tested evaluation board in an antistatic bag
- Quick Start Guide

### 3.2 Assumptions

Familiarity with the I<sup>2</sup>C bus is helpful but not required.

### 3.3 Static handling requirements

#### CAUTION



This device is sensitive to ElectroStatic Discharge (ESD). Therefore care should be taken during transport and handling. You must use a ground strap or touch the PC case or other grounded source before unpacking or handling the hardware.

### 3.4 Minimum system requirements

This evaluation board requires a Windows PC workstation. Meeting these minimum specifications should produce great results when working with this evaluation board.

- Computer with Windows 10
- One USB port (either 3.0 or 2.0 or 1.1 compatible)
- One of three EVK boards (MIMXRT1050-EVK, LPC55S69-EVK, 8MMINILPD4-EVK) along with the associated firmware / GUI software
- USB cable for power and data connection between PC and EVK board (if not included in the EVK package)

## 4 Getting to know the hardware

### 4.1 PCAL6408A-ARD features

- I/O connector for external access to IC input-output pins;
- 4 user switches connected to I/O pins of the IC;
- 4 user LEDs connected to I/O pins of the IC;
- Equipped with Arduino Uno R3 port for direct connection with Arduino devices;
- Fully compliant with IMXRT1050 EVK board, including GUI (Windows 10);
- Fully compliant with LPCXpresso55S69 dev. board, including GUI (Windows 10);
- Compliant with i.MX Mini LPDDR4 EVK board, including GUI (Windows 10);

*Note: For i.MX Mini LPDDR4 EVK Board is necessary to use IMX8MMINI-IARD interposer board between the EVK and PCAL6408A-ARD daughter board (see IMX8MMINI-IARD User Manual).*

### 4.2 Kit featured components

[Figure 1](#) identifies the main components on the board. The main elements are called out in the picture. The Arduino port connectors (J1, J2, J3, J4) are located on the bottom side of the board.

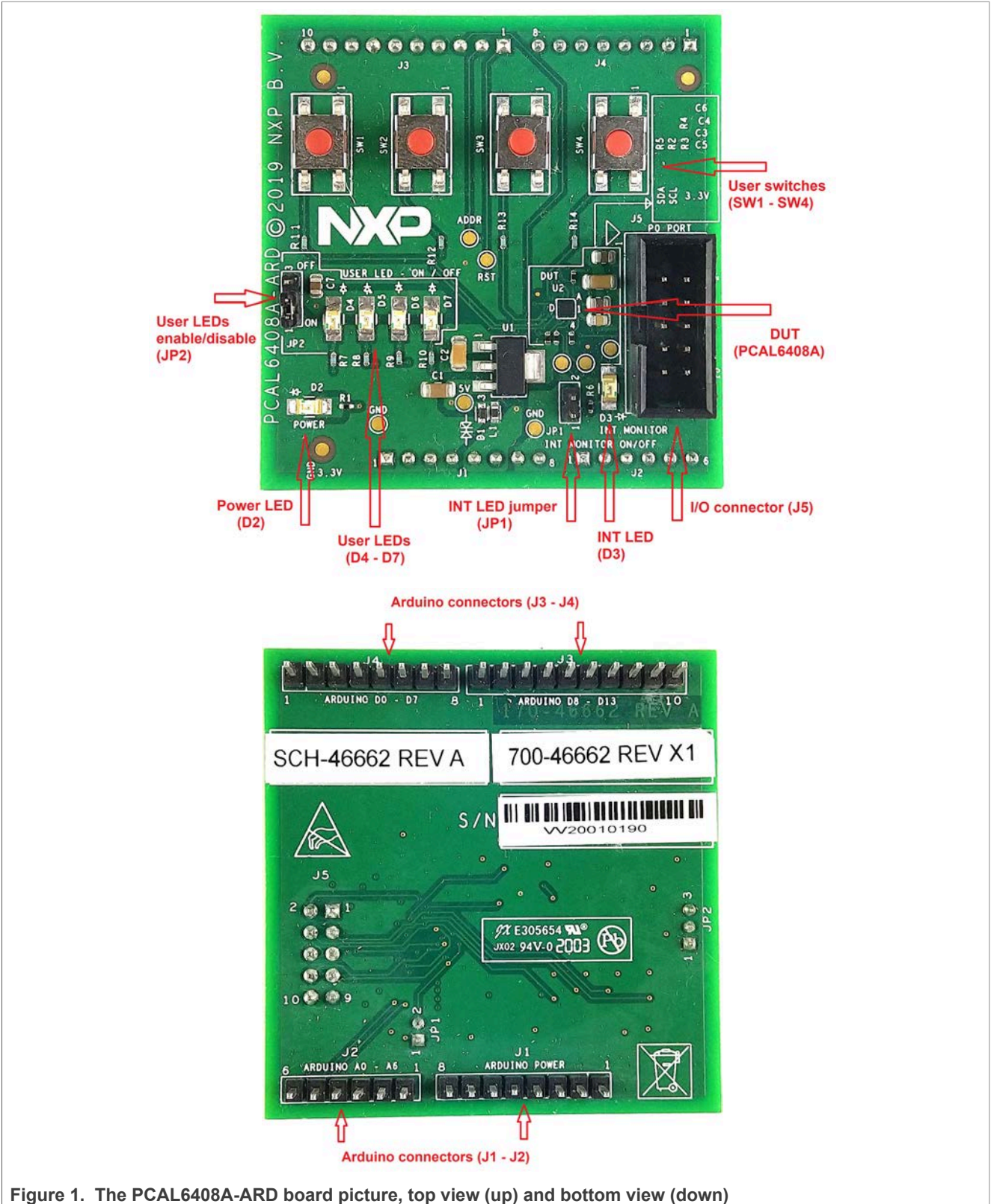

Figure 1. The PCAL6408A-ARD board picture, top view (up) and bottom view (down)

### 4.3 Block diagram

Figure 2 shows a block diagram of the PCAL6408A-ARD daughter board. Alongside the DUT (U2), the block diagram includes Arduino interface (J1, J2, J3, and J4 connectors), the IO external connector (J5), the on-board LEDs (D1, D2, D3, and D4), and switches (SW1, SW2, SW3, and SW4).

The IC is connected to the Arduino interface through two buses: a 3-bit control bus (J3) and the I<sup>2</sup>C-bus (J2). The I/O pins are connected to an 8-bit I/O port (J5) for direct access from external. On the I/O digital lines are connected four LEDs (the LSB lines) and four push button switches (the MSB lines). U1 is a 3.3V power rail regulator. The 3.3V power rail provides the power supply, both for PCAL6408A and LEDs.

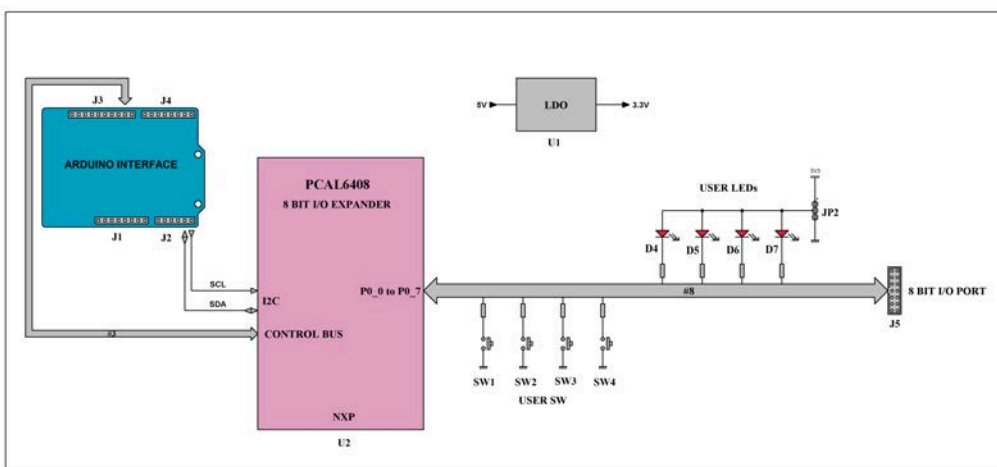

Figure 2. PCAL6408A-ARD block diagram

### 4.4 Schematic diagram

The schematic diagram of PCAL6408A-ARD is available at URL: <http://www.nxp.com/PCAL6408A-ARD>.

### 4.5 Arduino port

J1, J2, J3, and J4 are the mated pin headers of Arduino Uno R3 connectors, having the same electrical function and placed on the board, so that the daughter board can be directly inserted in the Arduino port. The daughter card is using only five signal lines.

Table 2 represents the pin chart of connectors, and the used lines in the circuit (see also the SPF-46662.pdf schematic file):

Table 2. The pin chart of Arduino connectors and their usage

Ref Des	#	Arduino label	PCAL6408A-ARD function
<b>J1 (Power)</b>	1	NC	Not used
	2	IOREF	Not used
	3	RESET	Not used
	4	3.3V	Not used
	5	5V	Power supply
	6	GND	Power supply return

Table 2. The pin chart of Arduino connectors and their usage...continued

Ref Des	#	Arduino label	PCAL6408A-ARD function
	7	GND	Power supply return
	8	Vin	Not used
J2 (analog, digital, I <sup>2</sup> C)	1	A0	Not used
	2	A1	Not used
	3	A2	Not used
	4	A3	Not used
	5	A4 / SDA	I <sup>2</sup> C – SDA
	6	A5 / SCL	I <sup>2</sup> C – SCL
J4 (digital, UART, PWM)	1	D0 / RX	Not used
	2	D1 / TX	Not used
	3	D2	Not used
	4	D3 / PWM	Not used
	5	D4	Not used
	6	D5 / PWM	Not used
	7	D6 / PWM	Not used
	8	D7	Not used
J3 (mixed)	1	D8	RESET (control bus)
	2	D9 / PWM	ADDR (control bus)
	3	D10 / SS / PWM	INT (control bus)
	4	D11 / MOSI / PWM	Not used
	5	D12 / MISO	Not used
	6	D13 / SCK	Not used
	7	GND	Power supply return
	8	AREF	Not used
	9	A4 / SDA	Not used
	10	A5 / SCL	Not used

The circuit is supplied with 5V from Arduino port through J1 and J3. Pin no. 5 of J1 is 5V power supply, while pin no. 6, 7 of J1, and pin no. 7 of J3 represents the power supply return (ground).

## 4.6 I<sup>2</sup>C bus

The PCAL6408A communicates with the host through an I<sup>2</sup>C bus (pin A4 – SCL, pin B3 – SDA). The communication provides internal configuration of the I/O expander, reads the logic levels of the I/O pins configured as inputs, and sets the logic level on the I/O pins configured as outputs. The internal configuration of the DUT includes direction of the digital I/O lines (input or output), polarity inversion, pull-up / pull-down resistor enable, output strength, output configuration (push-pull or open-drain), input latch configuration, and interrupt register. The transaction speed of I<sup>2</sup>C the bus is compliant with Standard-mode (100kHz), and Fast-mode (400kHz). For more details about I<sup>2</sup>C description and



bus transactions, see PCAL6408A datasheet (NXP Semiconductors). The pull-up resistors of the I<sup>2</sup>C bus are R2 and R3 (see SPF-46662.pdf schematic file).

#### 4.7 Control bus

The control bus manages RESET, ADDR, and INT pins of the PCAL6408A IC. The RESET pin is digital input and is controlled by the system host. Its role is to reset the I/O expander when a time-out or other improper operation occurs. Asserting a low level of this line, forces a reset operation of the internal control section of the IC (puts the internal registers in their default state and forces a re-initialization of the I<sup>2</sup>C state machine, in the same manner as power-on sequence). The RESET pin is controlled by the EVK motherboard through J3-1 (ARDUINO port).

The ADDR pin is digital input and represents a programmable hardware address package which can be asserted low or high, to assign two different slave addresses. The input is controlled by the EVK through J3-2 (ARDUINO port).

The INT pin is an open-drain interrupt output, activated when any input state differs from its corresponding input port register state, indicating to the host system that an input state has changed. The line is monitored by the EVK through J3-3 ARDUINO port and locally by the LED (D3) located on the daughter board. The LED D3 can be deactivated by removing JP1 jumper. When D3 is inactive (JP1 removed) the open-drain is polarized through R5. R5 also has the role to compensate the voltage drop of D3 assuring 3.3V high level in high state of the interrupt line (see SPF-46662.pdf schematic file).

#### 4.8 I/O bus

The P0 to P3 pins of the DUT are configured as digital outputs. The lines are driving the on-board LEDs D4 to D7. The P4 to P7 pins are configured as digital inputs. The on-board switches SW1 to SW4 are connected on the inputs, so that the user can change the logic state from the switches located on the daughter board. All eight I/O lines are connected to connector J5. [Table 3](#) shows the configuration of the I/O bus of the PCAL6408A-ARD daughter board.

**Table 3. The J5 pin chart**

U2 pin name (number)	Wire label	On-board LEDs	On-board switches	I/O ext. conn. (J5)
P0 (B1)	IO_0	D4	-	2
P1 (C2)	IO_1	D5	-	3
P2 (C1)	IO_2	D6	-	4
P3 (D1)	IO_3	D7	-	5
P4 (D3)	IO_4	-	SW1	6
P5 (D4)	IO_5	-	SW2	7
P6 (C4)	IO_6	-	SW3	8
P7 (C3)	IO_7	-	SW4	9

The on-board LEDs can be disabled by placing JP2 jumper in 2-3 position (OPTION 1, see SPF-46662.pdf file). This feature is useful when the user uses the board with external device connected to J5 I/O port. The switches are connected to the bus through 620-ohm series resistors (R11 – R14), to avoid bus conflict (short-circuit if the lines P4 to P7 are set accidentally as outputs accidentally and one or more switches are pressed).

### 4.9 Jumpers and test points

The board contains two jumpers and several test points. [Table 4](#) and [Figure 3](#) detail the jumper locations and their default configurations. [Table 5](#) describes the test points located on the PCAL6408A-ARD board.

Table 4. PCAL6408A-ARD jumpers

Ref Des	Label	Default	Description
JP1	INT MONITOR ON / OFF	OFF	OFF: Disable the interrupt monitor LED (D3)
			ON: Enable the interrupt monitor LED (D3)
JP2	USER LED – ON / OFF	1-2	1-2: Enable the user LEDs (D4 – D7)
			2-3: Disable the user LEDs (D4 – D7)

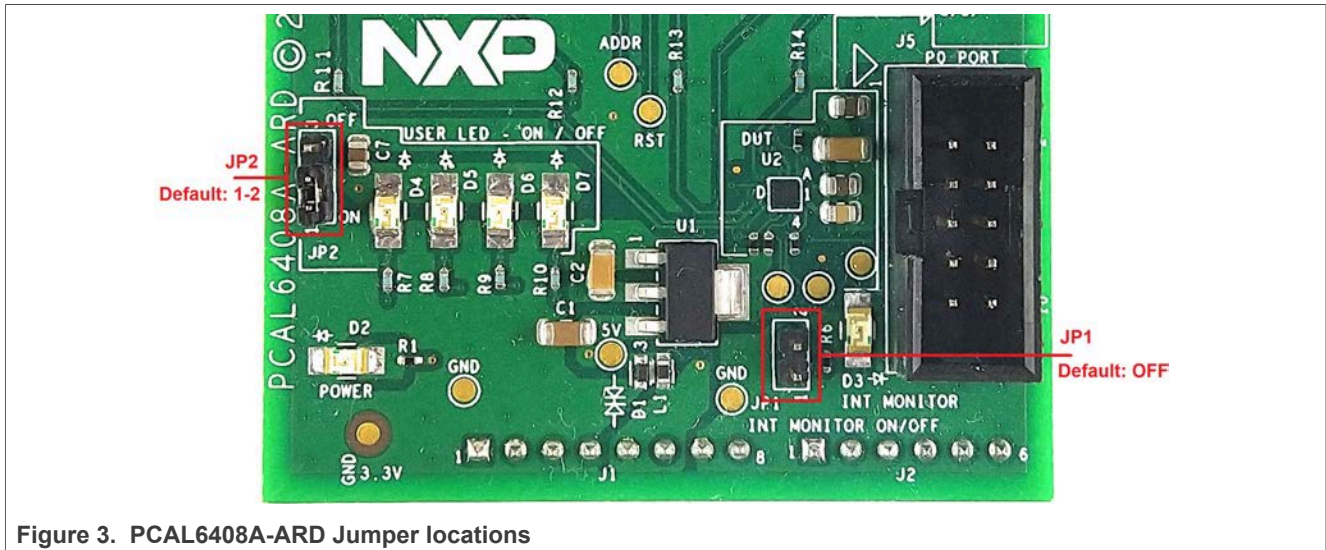

Figure 3. PCAL6408A-ARD Jumper locations

Table 5. PCAL6408A-ARD test points

Ref Des	Test point / jumper label	Description
TP1	5V	The 5V power supply
TP2	3.3V	The 3.3V power rail
TP3	GND	Ground
TP4	GND	Ground
TP5	SDA	The SDA line (I <sup>2</sup> C bus)
TP6	SCL	The SCL line (I <sup>2</sup> C bus)
TP7	RST	The RESET input of PCAL6408A
TP8	ADDR	The ADDR input of PCAL6408A

## 5 Installing and configuring software tools

PCAL6408A\_ARD evaluation board is designed and built as a daughter board able to work in conjunction with a mother board equipped with an Arduino port. The board was built to be fully compatible with the following NXP Evaluation (EVK) boards:

- IMXRT1050 EVK Board;
- LPCXpresso55S69 Development Board;
- i.MX 8M Mini LPDDR4 EVK Board;

Each mentioned above evaluation / development board benefits by firmware support which can be downloaded from NXP company site ([www.nxp.com/](http://www.nxp.com/)). Before starting, the EVK motherboard must be programmed with the corresponding firmware package. Additionally, a GUI application (Windows 10) is available for download from the NXP site, allowing rapid testing and operation of PCAL6408A-ARD daughter board through the one of above mentioned EVKs. The GUI application is common for all three EVKs and for the PCAL6xxx I/O expander development card family, manufactured by NXP (PCAL6408A, PCAL6416A, PCAL6524 and PCAL6534 ICs). For details regarding installation of the EVK firmware and GUI host software on PC please download [EVK\\_Firmware\\_And\\_GUI\\_Install\\_Guide\\_For\\_Arduino\\_Boards.pdf](#) instruction file from NXP site ([www.nxp.com/](http://www.nxp.com/)). Once the software is installed, the first step is to select the correct combination EVK – PCAL6408A-ARD daughter card, and then the board can be controlled from the GUI interface. See [Section 6](#) and [Section 7](#) for more details regarding the operation of PCAL6408A-ARD from GUI software.

## 6 Configuring the hardware

### 6.1 Using the PCAL6408A-ARD with an IMXRT1050 EVK board

[Figure 4](#) shows the required hardware for operation of the PCAL6408A-ARD daughter board with IMXRT1050 EVK. The following items are necessary:

- One IMXRT1050-EVK board
- One PCAL6408A-ARD daughter board
- One USB-A / USB Micro-B cable
- A PC with Windows 10 operating system

The IMXRT1050 EVK mother board can be powered by one of the three methods:

- Connecting an external 5VDC power supply to the barrel power connector (J2) on the board
- Connecting an USB cable from the PC to the Micro-B USB connector (J9) on the board
- Connecting an USB cable from the PC to the USB connector (J28) on the board. When the PC is connected in this fashion, the USB port can simultaneously act as a debug interface. Therefore, by using a single USB cable connected to J28, the EVK can be powered and at the same time linked to the PC for data exchange.

The older USB ports (from PC) are not able to deliver the necessary current (500mA), before establishing the communication, use an external power supply (connected to J2).

From J1 on the EVK board (see [Figure 6](#)) the user can select the power configuration for the mother board. For further details, refer to the [MIMXRT1050 EVK Board Hardware User's Guide](#).

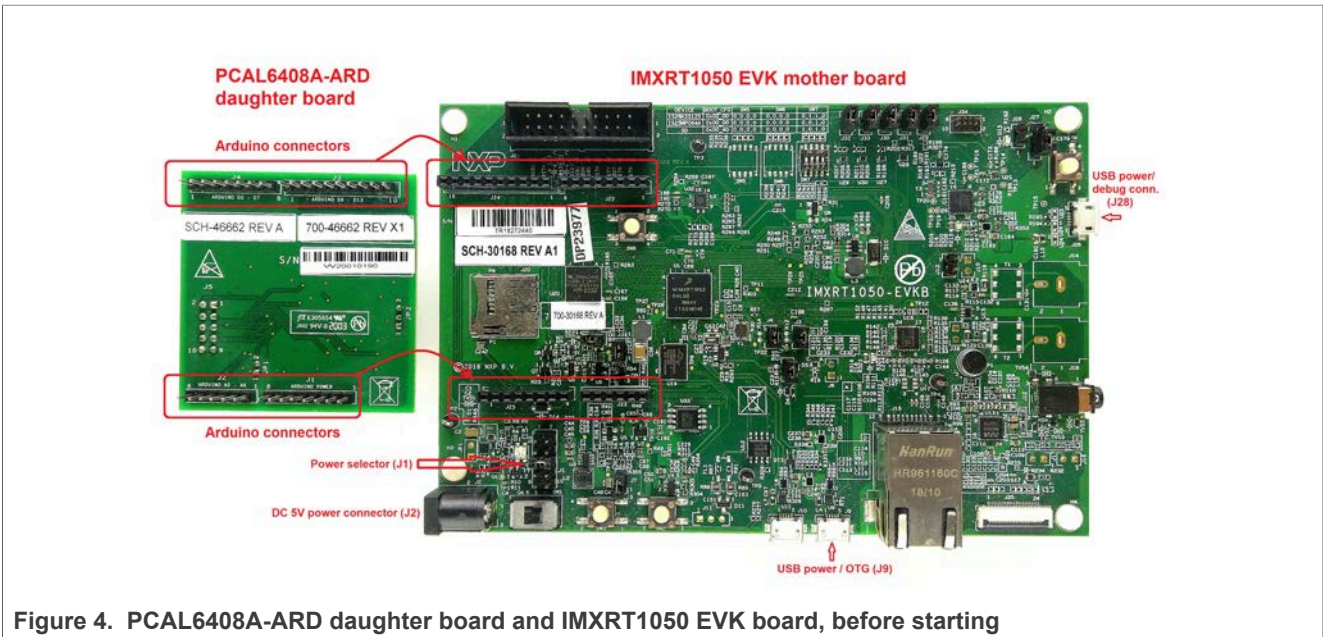

Figure 4. PCAL6408A-ARD daughter board and IMXRT1050 EVK board, before starting

To configure the hardware and workstation, complete the following procedure:

1. Configure the suitable power configuration of EVK (J1). If using J28 for power supply, the J1 jumper shall be placed in position 5-6. If using an external power supply (connected to J2), the jumper J1 will be placed in position 1-2.
2. Insert the PCAL6408A-ARD daughter card on the Arduino connector of the EVK (see [Figure 4](#)).
3. Using USB connector J28, connect the EVK board to an USB port of the computer.
4. Install the IMXRT1050 target firmware (download from NXP site and see UM11581, Arduino [Arduino shields GUI and firmware installation manual](#) for step-by-step instructions).
5. Install GUI application (see [UM11581, Arduino shields GUI and firmware installation manual](#)).
6. Open the GUI application to operate the device from the PC. For details regarding GUI operation see [Section 7](#).

[Figure 5](#) shows the boards during the operation.

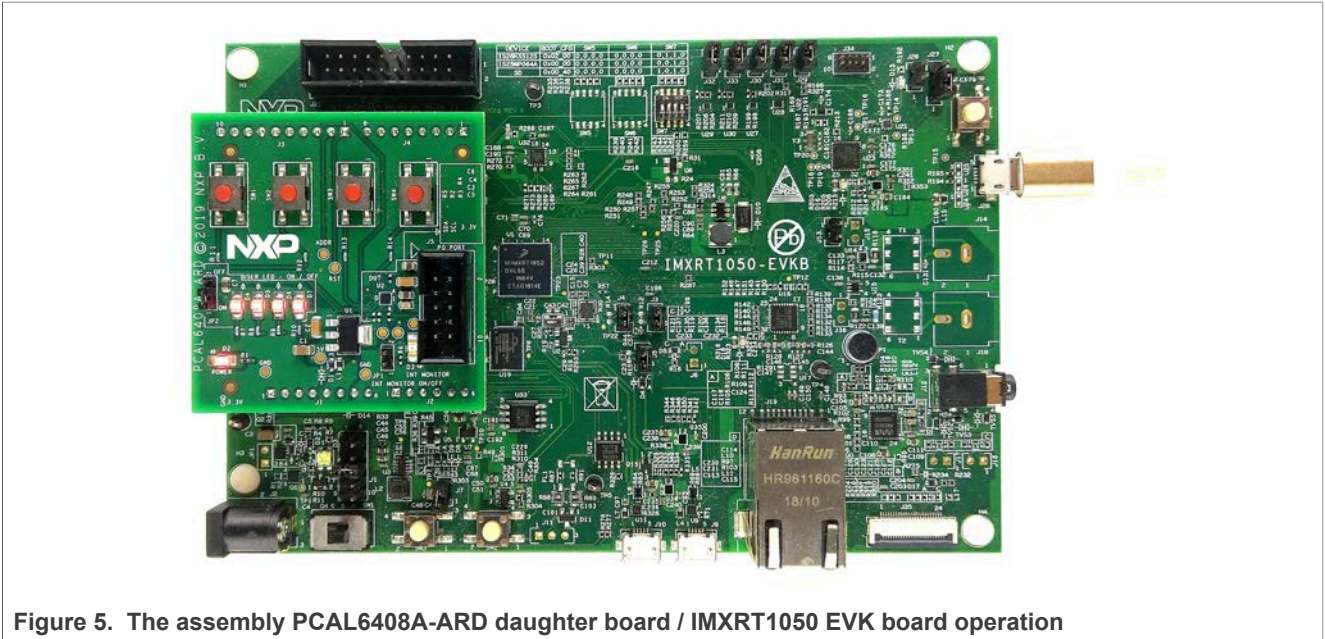

Figure 5. The assembly PCAL6408A-ARD daughter board / IMXRT1050 EVK board operation

## 6.2 Using the PCAL6408A-ARD with an LPCXpresso55S69 development board

Figure 6 shows the required hardware for operation of the PCAL6408A-ARD and LPCXpresso55S69 EVK board. This configuration consists of:

- One LPCXpresso55S69 EVK board
- One PCAL6408A-ARD daughter board
- One USB-A / USB Micro-B cable
- A PC with Windows 10 operating system

The LPCXpresso55S69 development board is equipped with four USB Micro-B connectors: P5, P6, P9 and P10. The board can be powered through any USB port. Using P6 USB connector to connect the board to the PC simplifies the start-up operation because P6 is designated for debugging and the USB cable thus accomplishes two tasks at the same time: powering the board, and serving as a data link between the EVK board and PC. For more details regarding power-up and operation of the LPCXpresso55S69 development board, see the *LPCXpresso55S69/LPCXpresso55S28 Development Board User Manual* [here](#).

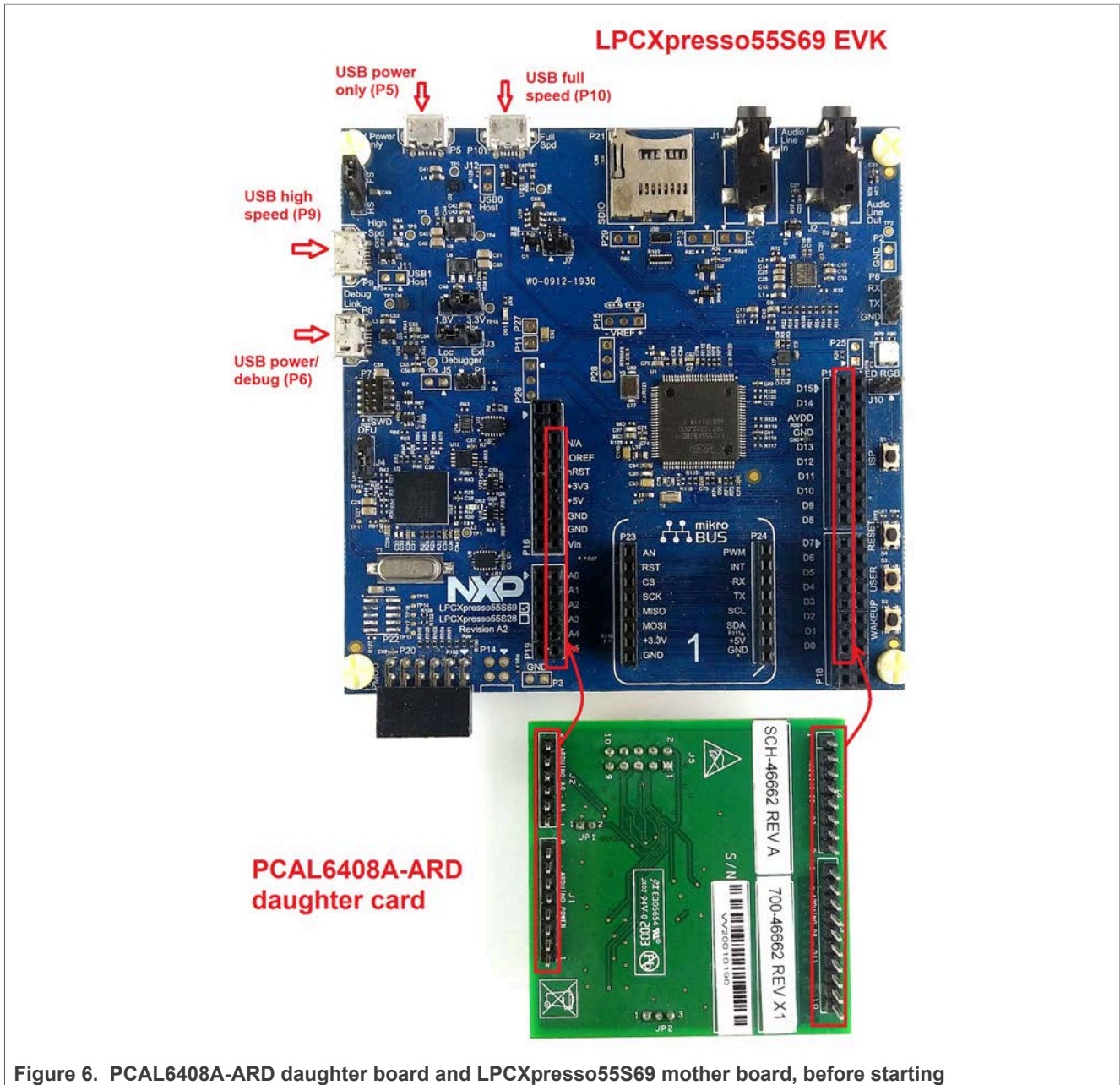

Figure 6. PCAL6408A-ARD daughter board and LPCXpresso55S69 mother board, before starting

The following steps describe how to assemble, program, and operate the configuration shown in [Figure 6](#).

1. Insert the PCAL6408A-ARD daughter card to P16 – P19 connectors located on LPCXpresso55S69 development board (see the marked pins of P16 – P19, [Figure 6](#))
2. Connect the development board using port P6 USB port of PC
3. Install the LPCXpresso55S69 target firmware (download from NXP site and read the *EVK\_Firmware\_And\_GUI\_Install\_Guide\_For\_Arduino\_Boards.pdf* instruction file)
4. Install GUI application on PC (see the instruction file called out in the previous step)
5. Open the GUI application to operate the device from the PC. For details regarding GUI operation see [Section 7](#)

[Figure 7](#) shows the two boards in operation.

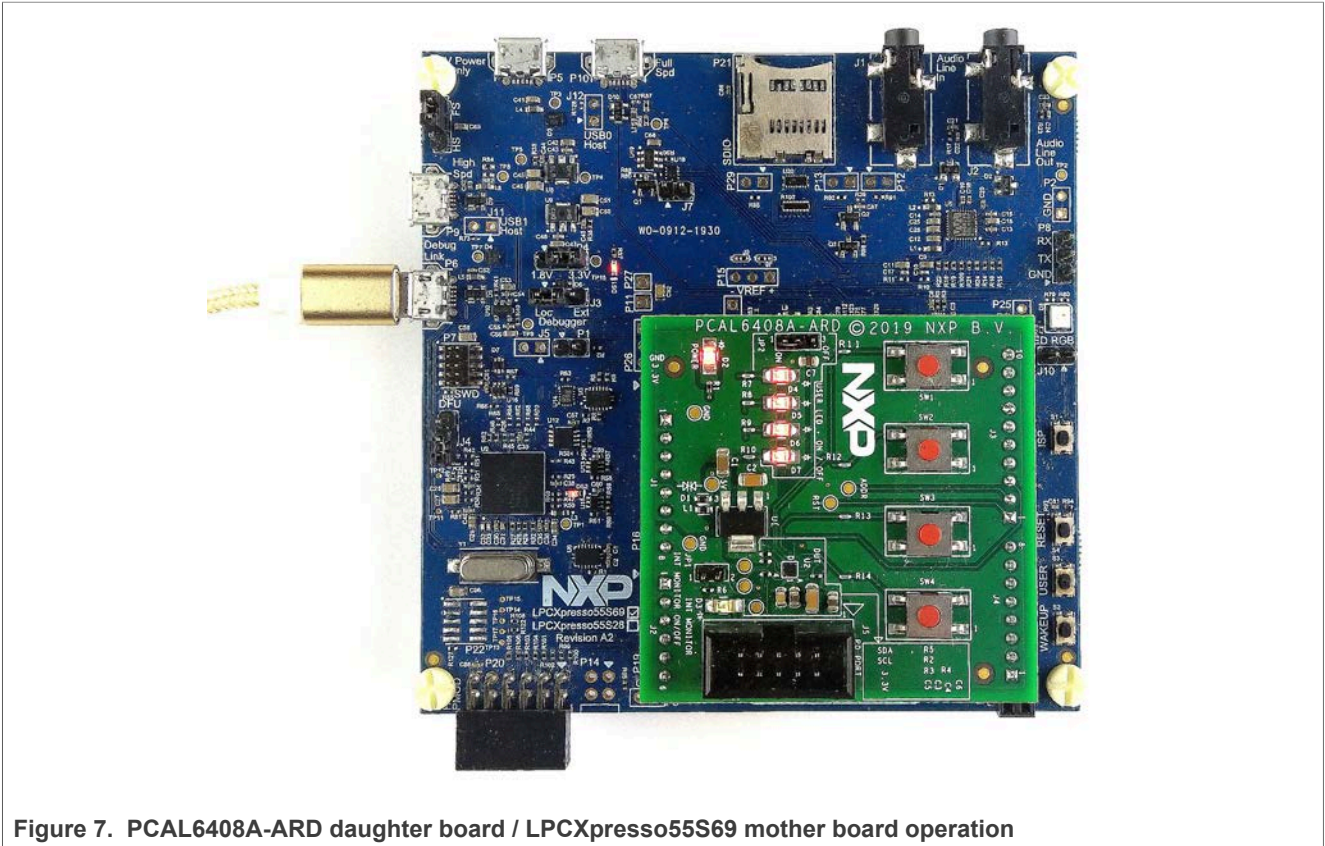

Figure 7. PCAL6408A-ARD daughter board / LPCXpresso55S69 mother board operation

### 6.3 Using the PCAL6408A-ARD with an i.MX 8M Mini LPDDR4 EVK board

When an i.MX 8M Mini LPDDR4 EVK board is used with the PCAL6408A-ARD board, a third board (IMX8MMINI-IARD interposer board) must be used, especially designed and built as EVK – daughter board interconnection. The EVK board i.MX 8M Mini LPDDR4 is not equipped with an Arduino port; instead it has a 2 x 20 pin expansion connector (J1003, see i.MX 8M Mini LPDDR4 EVK user manual). J1003 is a multipurpose port, containing various digital I/O lines, including specialized I<sup>2</sup>C and SPI buses. Starting from the expansion connector pin chart, an Arduino port interposer board was developed, with the role of signal-to-signal bridge between the 2 x 20 connector pins on the i.MX 8M Mini LPDDR4 EVK and the mated connectors of the Arduino port present on the PCAL6408A-ARD daughter board.

To operate the setup, along with the EVK and the daughter board, a third board must be included in the setup assembly. [Figure 8](#) shows the necessary boards and how these boards are connected. The configuration consists of:

- One i.MX 8M Mini LPDDR4 EVK board
- One PCAL6408A-ARD daughter board
- One IMX8MMINI-IARD interposer board
- One USB-A / USB-C cable
- One USB-A / USB Micro-B cable
- A PC with Windows 10 operating system

It is recommended to attach the PCAL6408A-ARD to the Arduino connectors of the IMX8MMINI-IARD interposer board first, and then the resulting assembly to the i.MX 8M

Mini LPDDR4 EVK. This can be done by plugging J1 connector located on the interposer board to J1003 connector on the EVK.

To power-up the EVK, an USB-C type cable connected to PORT 2 of the EVK is used. The power switch SW101 on the EVK board must be set to ON position to power-up the setup. Data communication is achieved by routing a separate USB (Micro-B type) cable from an USB port on the PC to debug port (J901) on the EVK (see [Figure 8](#) and [Figure 9](#)).

The user may find details regarding power-up and operation of the setup assembly in 8MMINI-LPDDR4-EVK user manual and IMX8MMINI-IARD User Manual. The files can be downloaded from [www.nxp.com/](http://www.nxp.com/).

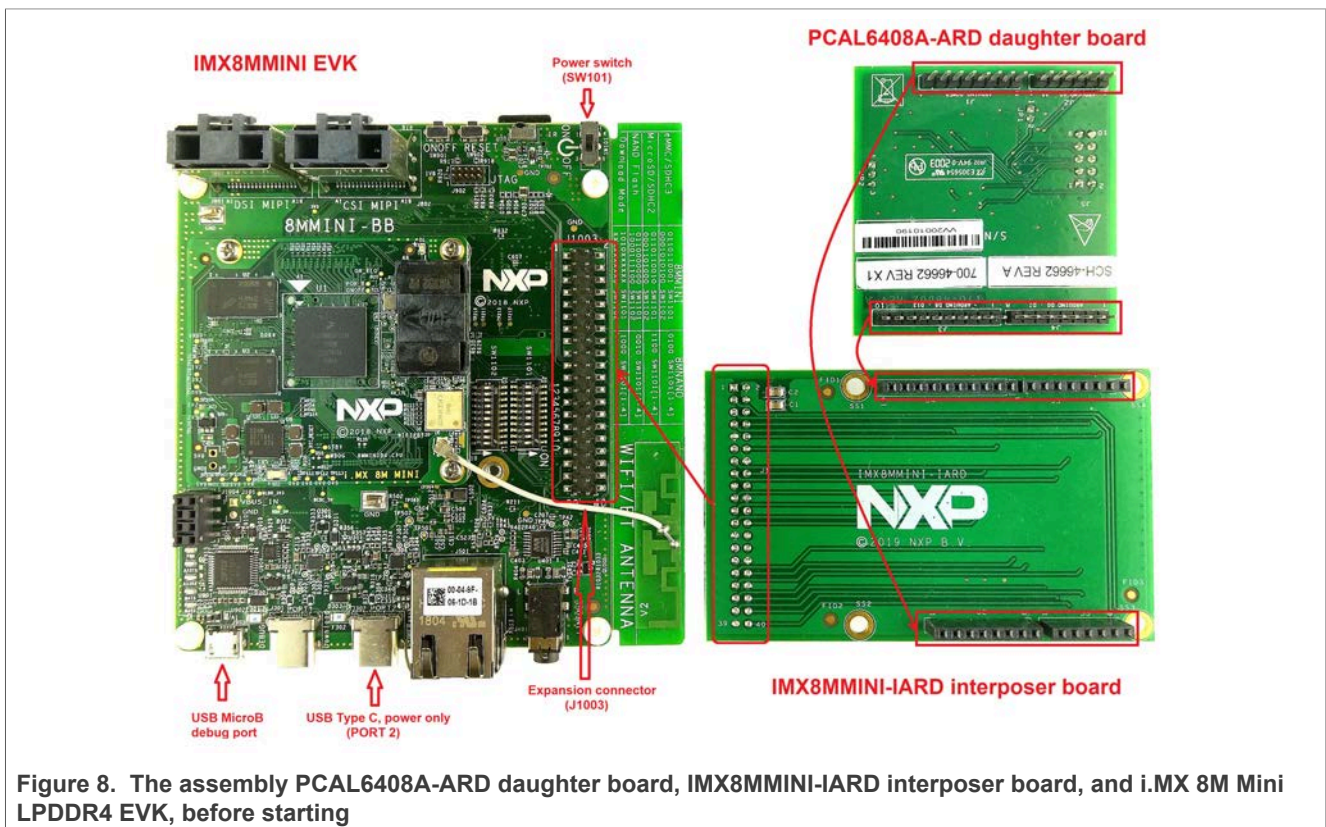

Figure 8. The assembly PCAL6408A-ARD daughter board, IMX8MMINI-IARD interposer board, and i.MX 8M Mini LPDDR4 EVK, before starting

To configure and operate the setup, follow the below steps:

1. Insert the PCAL6408A-ARD onto the IMX8MMINI-IARD interposer board Arduino connectors (located on the top side)
2. Attach IMXMMINI-IARD connector plug J1 (located on the bottom of the board) into J1003 expansion board located on the top side of i.MX 8M Mini LPDDR4 EVK (see [Figure 8](#))
3. Power-up the EVK board using an USB Type C cable attached to PORT 2
4. Connect the EVK to the PC, using an USB Micro-B cable, attached to J901 debug port
5. Place SW101 in ON position to power-up the boards
6. Install the MIMXRT1050 target firmware (download [UM11581, Arduino shields GUI and firmware installation manual](#) from NXP site)
7. Install GUI application on the PC (see the instruction file referred in the above step)



- Open the GUI application to operate the device from the PC. For details regarding GUI operation see [Section 7](#)

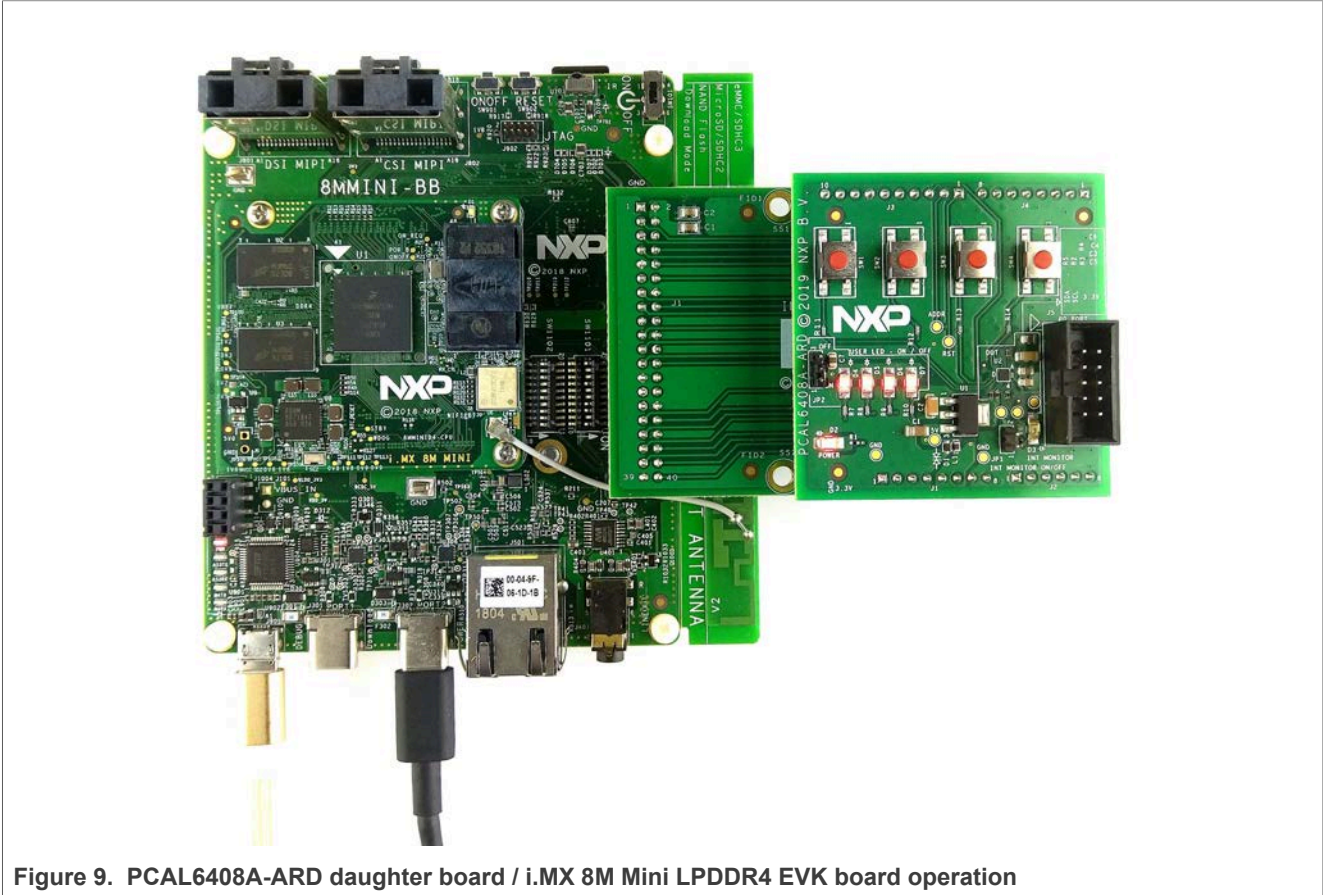

Figure 9. PCAL6408A-ARD daughter board / i.MX 8M Mini LPDDR4 EVK board operation

### 6.4 Using PCAL6408A-ARD with another device

The PCAL6408A-ARD daughter board can be operated with other EVK board, which has an Arduino port. There are two options to connect the board: using an EVK equipped with an Arduino port, and an EVK without an Arduino port. In the first case, a firmware shall be developed according with PCAL6408A specifications, and then simply attach PCAL6408A-ARD daughter board to the EVK, to operate the board. In the second case, using the pin chart of Arduino connectors ([Table 2](#)), make the necessary electrical connections (for power, I<sup>2</sup>C-bus and control lines), and develop the desired firmware, assuring that is compliant with IC specifications. Use PCAL6408A datasheet to read details about internal registers of the DUT IC and data exchange between internal controller and the EVK. Assure for correct electrical connections and avoid data conflicts on the signal lines, to prevent IC damage.

## 7 GUI description

A GUI application is available for the three EVK boards from NXP Semiconductors. The application is common for all EVKs and the development boards of the entire family of IO expanders produced by NXP Semiconductors (PCAL6408A-ARD, PCAL6416AEV-ARD, PCAL6524EV-ARD, and PCAL6534EV-ARD).

This section describes the GUI application and how the user can control the PCAL6408A-ARD daughter board from the graphical interface. First, install the GUI package and software on the PC (Windows 10). For more details, see [UM11581](#).

Once installation is complete, assure that one of the mentioned three EVK with attached PCAL6408A-ARD daughter board is connected to PC and powered-on. Open NXP\_(PCAL65x4,PCAL64xxA) GUI application. An interface will appear as is shown in [Figure 10](#):

The GUI application starts with **Settings** tab (marked with red arrow). The left side of the window displays **Board settings**. The section provides the following settings:

- **Select EVK:** displays the list of EVKs. Selecting a wrong EVK board causes the connection to fail and a pop-up window with the message: *“Unable to Connect with EVK”* appears on the screen.
- **Select COM port:** displays port selected for the communication. The port is automatically selected by the system (in the picture is COM 3).
- **Select Board:** allows the user to select the correct daughter board (the application can support four different boards). In [Figure 10](#), the selected board is PCAL6408A. Selecting a wrong daughter board causes the connection to fail and a pop-up window with the message: *“Unable to Connect with Daughter Card”* appears on the screen.

In the right side of the window is located **Device setting** section. The following settings are provided:

- **I2C Frequency:** displays the I<sup>2</sup>C-bus clock frequency (100kHz and 400kHz). With the **Set** button the value is written in the internal register of PCAL6408A IC.
- **Address Selection:** allows the user to select the hardware address of PCAL6408 IC.
- **Reset Chip:** reset the internal register of PCAL6408A.

Assuming the correct parameters are chosen, clicking the **Connect** button establishes the connection with the EVK. In the bottom side of the GUI window a status bar shows in real time the status regarding connection between PC and the EVK.

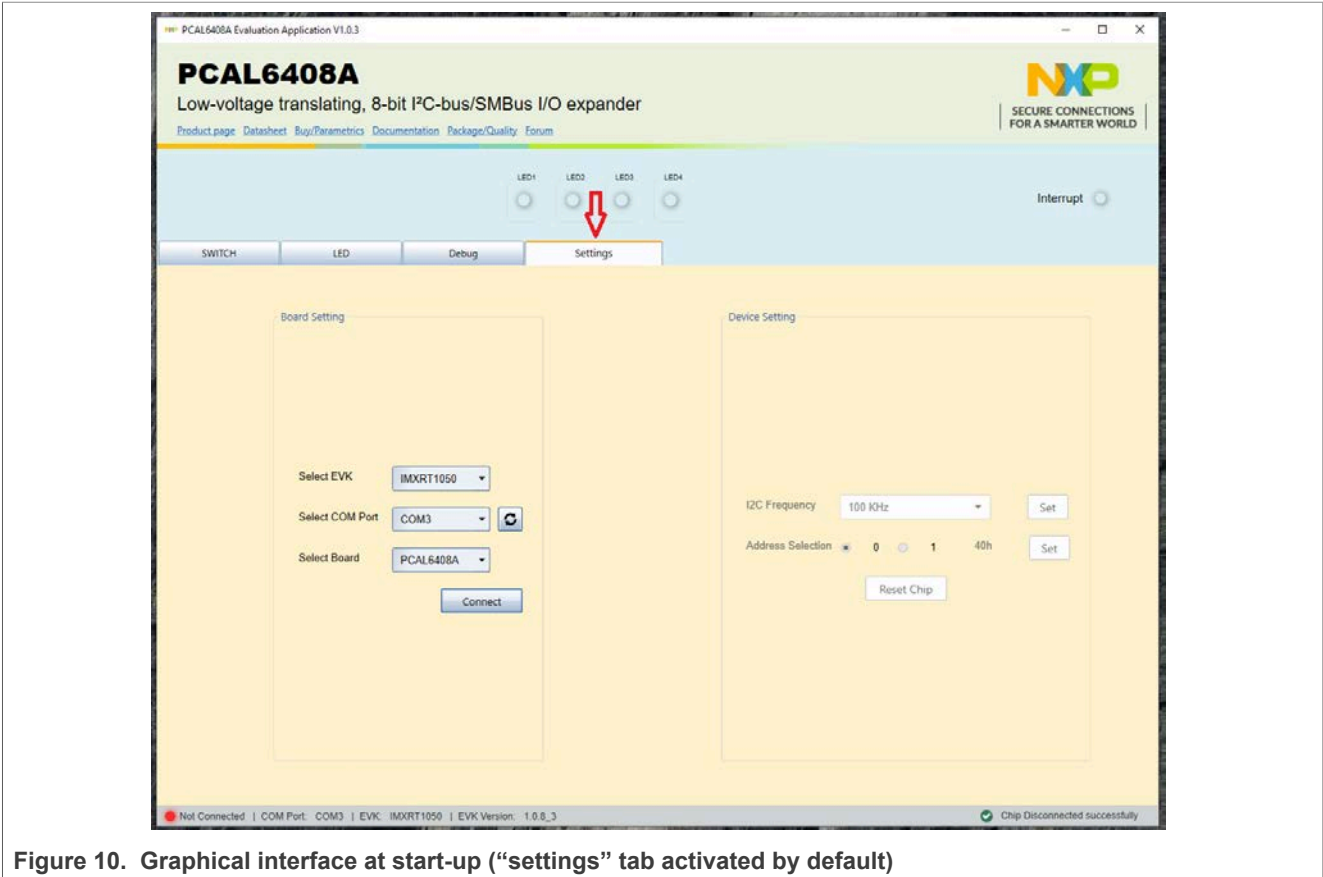

Figure 10. Graphical interface at start-up (“settings” tab activated by default)

Clicking on **SWITCH** tab, a new window appears (see Figure 11). In the left side of the window, the parameters of the IO connected to on-board switches (SW1 to SW4) can be set. The parameters are:

- **Latch:** enable / disable the corresponding latch of the input.
- **Pull Up/Down Enable:** enable / disable the internal pull-up or pull-down resistor.
- **Pull UP/Down Selection:** select the internal pull-up or pull-down resistor.
- **Interrupt Mask:** enable / disable the interrupt mask for the input;
- **Polarity Inversion:** enable / disable the polarity inversion function for the input;

The **Write** button sets the internal registers of the DUT with the selected value in the GUI. The switches on-board switches (SW1 to SW4) does not have pull-up resistors, the user should select and activate the internal pull-up resistors from the GUI. In the right side of the window, the **Read** button, bring the current status of the registers on the graphical user interface.

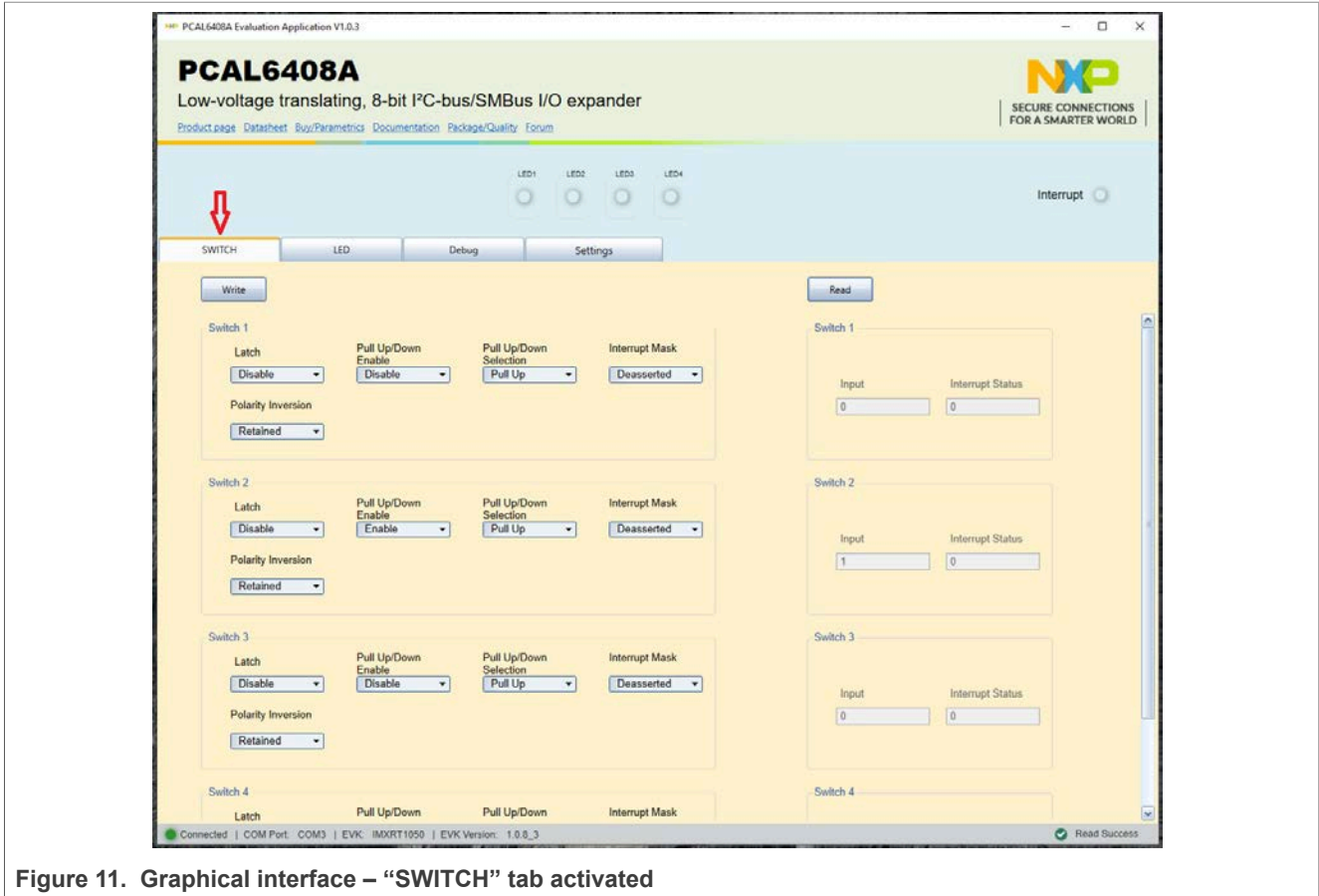

Figure 11. Graphical interface – “SWITCH” tab activated

The **LED** tab, allows the user to control the on-board user LEDs D4 to D7. (see [Figure 12](#)). In the yellow area of the window, the parameters of the IO connected to on-board user LEDs can be set. The parameters are:

- **Value:** set the status of the on-board user LED (the logic state of the output).
- **Output drive strength:** sets the drive strength of the output.

The **Write** button sets the internal registers of the DUT with the selected value in the GUI. In the upper side of the window (the blue region) the LED1 to LED4 indicators displays the current state of the on-board LEDs (D4 to D7).

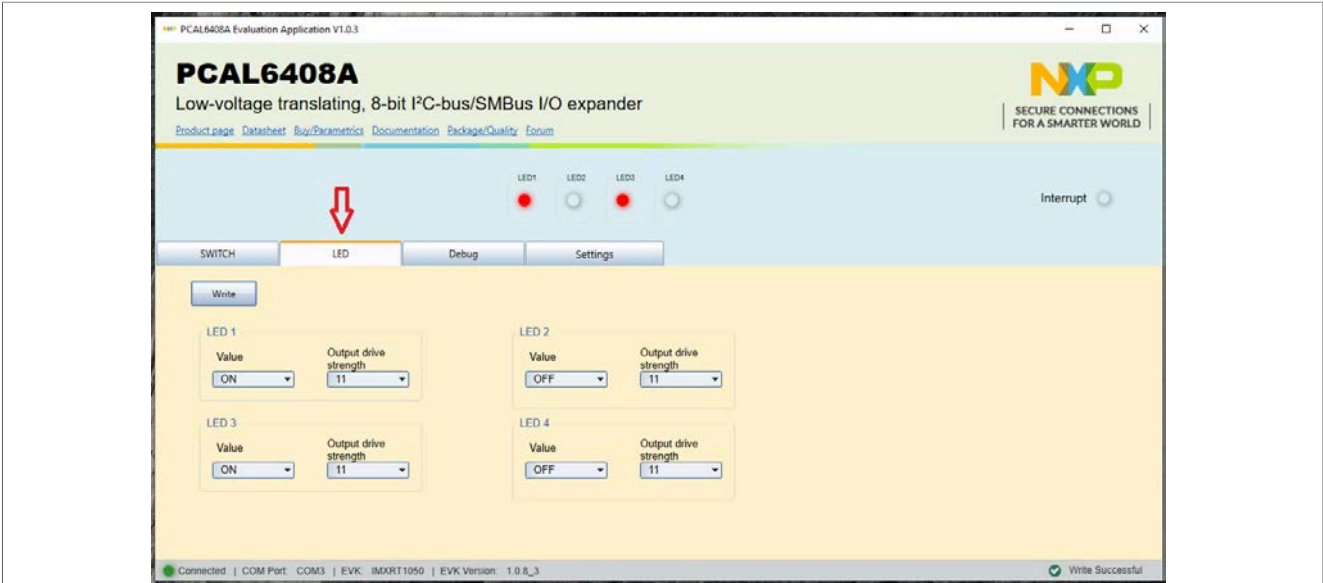

Figure 12. Graphical interface – “LED” tab activated

The **Debug** tab (Figure 13) displays the current value of the internal registers of the IC, every time when **Read** button is clicked. To find details about internal registry see the PCAL6408A datasheet.

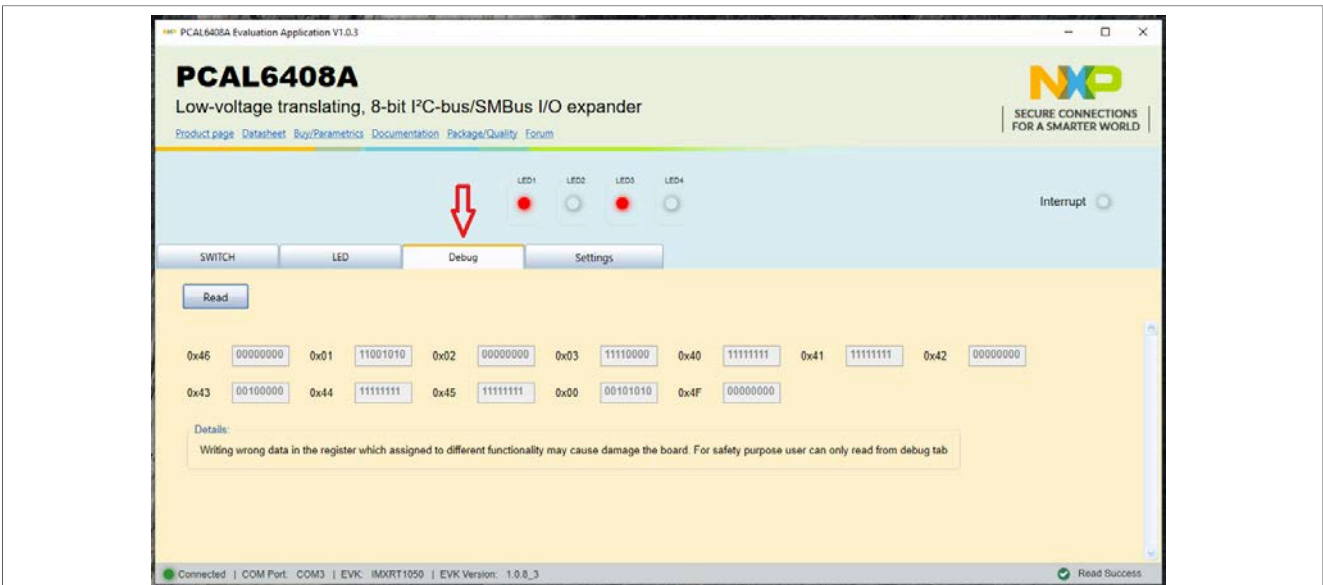

Figure 13. Graphical interface – “Debug” tab activated

## 8 Abbreviations

Table 6. Abbreviations

Acronym	Description
DUT	Device Under Test
ESD	Electro Static Discharge
EVK	Evaluation Board
GUI	Graphical User Interface
I <sup>2</sup> C bus	Inter-Integrated Circuit bus
IC	Integrated Circuit
I/O	Input / Output
LED	Light Emitting Diode
PC	Personal Computer
USB	Universal Serial Bus

## 9 References

1. *PCAL6408A, Low-voltage translating, 8-bit I<sup>2</sup>C-bus/SMBus I/O expander with interrupt output, reset, and configuration registers*  
Product data sheet; NXP Semiconductors;
2. *MIMxrt1050 EVK Board Hardware User's Guide*  
User manual; NXP Semiconductors;
3. *i.MX RT1050 Crossover Processors Data Sheet for Consumer Products*  
Data sheet; NXP Semiconductors;
4. *UM11158 – LPCXpresso55S69 Development Board*  
User manual; NXP Semiconductors;
5. *LPC556x 32-bit ARM Cortex-M33; M33 coprocessor, TrustZone, PowerQuad, CASPER, 320KB SRAM; 640 KB flash, USB HS, Flexcomm Interface, SDIO, 32-bit counter/timers, SCTimer/PWM, PLU, 16-bit 1.0 Msamples/sec ADC, Comparator, Temperature Sensor, AES, PUF, SHA, CRC, RNG*  
Product data sheet; NXP Semiconductors;
6. *i.MX 8M Mini LPDDR4 EVK Board Hardware User's Guide*  
User guide; NXP Semiconductors;
7. *i.MX 8M Mini Application Processor Datasheet for Consumer Products*  
Data sheet; NXP Semiconductors;
8. *i.MX 8M Mini Application Processor Reference Manual*  
Reference manual; NXP Semiconductors;
9. *Arduino Uno R3 Reference Manual*  
Reference manual; NXP Semiconductors;
10. *IMX8MMINI-IARD interposer board User Manual*  
User manual; NXP Semiconductors;
11. *NXP EVK Firmware and GUI Installation Guide for Arduino Series Boards*  
User manual; NXP Semiconductors;

## 10 Legal information

### 10.1 Definitions

**Draft** — A draft status on a document indicates that the content is still under internal review and subject to formal approval, which may result in modifications or additions. NXP Semiconductors does not give any representations or warranties as to the accuracy or completeness of information included in a draft version of a document and shall have no liability for the consequences of use of such information.

### 10.2 Disclaimers

**Limited warranty and liability** — Information in this document is believed to be accurate and reliable. However, NXP Semiconductors does not give any representations or warranties, expressed or implied, as to the accuracy or completeness of such information and shall have no liability for the consequences of use of such information. NXP Semiconductors takes no responsibility for the content in this document if provided by an information source outside of NXP Semiconductors.

In no event shall NXP Semiconductors be liable for any indirect, incidental, punitive, special or consequential damages (including - without limitation - lost profits, lost savings, business interruption, costs related to the removal or replacement of any products or rework charges) whether or not such damages are based on tort (including negligence), warranty, breach of contract or any other legal theory.

Notwithstanding any damages that customer might incur for any reason whatsoever, NXP Semiconductors' aggregate and cumulative liability towards customer for the products described herein shall be limited in accordance with the Terms and conditions of commercial sale of NXP Semiconductors.

**Right to make changes** — NXP Semiconductors reserves the right to make changes to information published in this document, including without limitation specifications and product descriptions, at any time and without notice. This document supersedes and replaces all information supplied prior to the publication hereof.

**Suitability for use** — NXP Semiconductors products are not designed, authorized or warranted to be suitable for use in life support, life-critical or safety-critical systems or equipment, nor in applications where failure or malfunction of an NXP Semiconductors product can reasonably be expected to result in personal injury, death or severe property or environmental damage. NXP Semiconductors and its suppliers accept no liability for inclusion and/or use of NXP Semiconductors products in such equipment or applications and therefore such inclusion and/or use is at the customer's own risk.

**Applications** — Applications that are described herein for any of these products are for illustrative purposes only. NXP Semiconductors makes no representation or warranty that such applications will be suitable for the specified use without further testing or modification.

Customers are responsible for the design and operation of their applications and products using NXP Semiconductors products, and NXP Semiconductors accepts no liability for any assistance with applications or customer product design. It is customer's sole responsibility to determine whether the NXP Semiconductors product is suitable and fit for the customer's applications and products planned, as well as for the planned application and use of customer's third party customer(s). Customers should provide appropriate design and operating safeguards to minimize the risks associated with their applications and products.

NXP Semiconductors does not accept any liability related to any default, damage, costs or problem which is based on any weakness or default in the customer's applications or products, or the application or use by customer's third party customer(s). Customer is responsible for doing all necessary testing for the customer's applications and products using NXP Semiconductors products in order to avoid a default of the applications and the products or of the application or use by customer's third party customer(s). NXP does not accept any liability in this respect.

**Export control** — This document as well as the item(s) described herein may be subject to export control regulations. Export might require a prior authorization from competent authorities.

**Evaluation products** — This product is provided on an "as is" and "with all faults" basis for evaluation purposes only. NXP Semiconductors, its affiliates and their suppliers expressly disclaim all warranties, whether express, implied or statutory, including but not limited to the implied warranties of non-infringement, merchantability and fitness for a particular purpose. The entire risk as to the quality, or arising out of the use or performance, of this product remains with customer.

In no event shall NXP Semiconductors, its affiliates or their suppliers be liable to customer for any special, indirect, consequential, punitive or incidental damages (including without limitation damages for loss of business, business interruption, loss of use, loss of data or information, and the like) arising out of the use of or inability to use the product, whether or not based on tort (including negligence), strict liability, breach of contract, breach of warranty or any other theory, even if advised of the possibility of such damages.

Notwithstanding any damages that customer might incur for any reason whatsoever (including without limitation, all damages referenced above and all direct or general damages), the entire liability of NXP Semiconductors, its affiliates and their suppliers and customer's exclusive remedy for all of the foregoing shall be limited to actual damages incurred by customer based on reasonable reliance up to the greater of the amount actually paid by customer for the product or five dollars (US\$5.00). The foregoing limitations, exclusions and disclaimers shall apply to the maximum extent permitted by applicable law, even if any remedy fails of its essential purpose.

**Translations** — A non-English (translated) version of a document is for reference only. The English version shall prevail in case of any discrepancy between the translated and English versions.

**Security** — Customer understands that all NXP products may be subject to unidentified vulnerabilities or may support established security standards or specifications with known limitations. Customer is responsible for the design and operation of its applications and products throughout their lifecycles to reduce the effect of these vulnerabilities on customer's applications and products. Customer's responsibility also extends to other open and/or proprietary technologies supported by NXP products for use in customer's applications. NXP accepts no liability for any vulnerability. Customer should regularly check security updates from NXP and follow up appropriately. Customer shall select products with security features that best meet rules, regulations, and standards of the intended application and make the ultimate design decisions regarding its products and is solely responsible for compliance with all legal, regulatory, and security related requirements concerning its products, regardless of any information or support that may be provided by NXP.

NXP has a Product Security Incident Response Team (PSIRT) (reachable at [PSIRT@nxp.com](mailto:PSIRT@nxp.com)) that manages the investigation, reporting, and solution release to security vulnerabilities of NXP products.

### 10.3 Trademarks

Notice: All referenced brands, product names, service names, and trademarks are the property of their respective owners.

**NXP** — wordmark and logo are trademarks of NXP B.V.

## Tables

Tab. 1.	Revision history .....	2	Tab. 4.	PCAL6408A-ARD jumpers .....	10
Tab. 2.	The pin chart of Arduino connectors and their usage .....	7	Tab. 5.	PCAL6408A-ARD test points .....	10
Tab. 3.	The J5 pin chart .....	9	Tab. 6.	Abbreviations .....	22

## Figures

Fig. 1.	The PCAL6408A-ARD board picture, top view (up) and bottom view (down) .....	6	Fig. 8.	The assembly PCAL6408A-ARD daughter board, IMX8MMINI-IARD interposer board, and i.MX 8M Mini LPDDR4 EVK, before starting .....	16
Fig. 2.	PCAL6408A-ARD block diagram .....	7	Fig. 9.	PCAL6408A-ARD daughter board / i.MX 8M Mini LPDDR4 EVK board operation .....	17
Fig. 3.	PCAL6408A-ARD Jumper locations .....	10	Fig. 10.	Graphical interface at start-up (“settings” tab activated by default) .....	19
Fig. 4.	PCAL6408A-ARD daughter board and IMXRT1050 EVK board, before starting .....	12	Fig. 11.	Graphical interface – “SWITCH” tab activated .....	20
Fig. 5.	The assembly PCAL6408A-ARD daughter board / IMXRT1050 EVK board operation .....	13	Fig. 12.	Graphical interface – “LED” tab activated .....	21
Fig. 6.	PCAL6408A-ARD daughter board and LPCXpresso55S69 mother board, before starting .....	14	Fig. 13.	Graphical interface – “Debug” tab activated .....	21
Fig. 7.	PCAL6408A-ARD daughter board / LPCXpresso55S69 mother board operation .....	15			