

Features

- RoHS compliant*
- Space saving design
- Wide range of resistance values
- Metric shaft and bushing option
- Mounting brackets available
- Linear or audio taper versions

Additional Information

Click these links for more information:



PC - "Slimline" 22 mm Square Single Turn Panel Control

Electrical Characteristics¹

Standard Resistance Range	
Linear Tapers.....	500 ohms to 1 megohm
Audio Tapers.....	1 K ohms to 500 K ohms
Total Resistance Tolerance.....	±20 %
Independent Linearity.....	±5 %
Absolute Minimum Resistance.....	5 ohms maximum
Effective Electrical Angle.....	270 ° ± 5 °
Contact Resistance Variation.....	7 % of total resistance
Dielectric Withstanding Voltage (MIL-STD-202, Method 301)	
Sea Level.....	1,000 VAC minimum
70,000 Feet.....	500 VAC minimum
Insulation Resistance (500 V).....	1,000 ohms minimum
Power Rating @ 70 °C (Voltage Limited by Power Dissipation or 350 VAC, Whichever is Less)	
Linear.....	.75 watt
Audio.....	.25 watt
Theoretical Resolution.....	Essentially infinite

Environmental Characteristics

Operating Temperature Range.....	+1 °C to +125 °C
Storage Temperature Range.....	-40 °C to +125 °C
Temperature Coefficient Over Storage Temperature Range.....	±1000 ppm/°C
Vibration.....	.20 G
Total Resistance Shift.....	±1 % maximum
Voltage Ratio Shift.....	±20 % maximum
Shock.....	.50 G
Total Resistance Shift.....	±1 % maximum
Voltage Ratio Shift.....	±20 % maximum
Load Life.....	1,000 Hours @ Rated Power, 20 % RH, 70 °C
Total Resistance Shift.....	±10 % maximum
Rotational Life (No Load).....	50,000 cycles
Total Resistance Shift (Linear taper).....	±10 ohms or 12 %, whichever is greater
Total Resistance Shift (Audio taper).....	±20 % maximum
Contact Resistance Variation.....	±5 % maximum
Moisture Resistance.....	MIL-STD-202, Method 103, Condition B
Total Resistance Shift.....	±20 % maximum
IP Rating.....	IP 40

Mechanical Characteristics

Stop Strength (1/4 " and 6 mm Shaft Diameters).....	79.09 N-cm (7 lb.-in.)
Mechanical Angle.....	300 ° ± 5 °
Torque	
Starting (Detented).....	0.5-1.5 N-cm (0.75-2.25 oz.-in.)
Starting (Undetented).....	1.5 N-cm (2.25 oz.-in.) maximum
Running (Undetented).....	0.18 to 1.06 N-cm (0.25 to 1.5 oz.-in.)
Mounting.....	79.09 N-cm (7 lb.-in.) maximum
Weight (Single Section).....	.21 gm (0.75 oz.) maximum
Terminals.....	.PC pin
Soldering Condition	
Manual Soldering.....	96.5Sn/3.0Ag/0.5Cu solid wire or no-clean rosin cored wire 370 °C (700 °F) max. for 3 seconds
Wave Soldering.....	96.5Sn/3.0Ag/0.5Cu solder with no-clean flux 260 °C (500 °F) max. for 5 seconds
Wash processes.....	Not recommended
Marking.....	Manufacturer's trademark, resistance value, part number, and date code
Ganging.....	1 cup maximum
Hardware.....	One lockwasher (H-37-2) and one mounting nut (H-38-11) is shipped with each potentiometer
Detents.....	Center, 10, 20, 30, none

For additional features or specifications not shown, consult factory.

FOR ORDERING INFORMATION SEE PAGE 4.

¹ Electrical specifications tested at 200 RPM, at room ambient: +25 °C nominal.

*RoHS Directive 2015/863, Mar 31, 2015 and Annex.

Specifications are subject to change without notice. Users should verify actual device performance in their specific applications. The products described herein and this document are subject to specific legal disclaimers as set forth on the last page of this document, and at www.bourns.com/docs/legal/disclaimer.pdf.



WARNING
Cancer and Reproductive Harm
www.P65Warnings.ca.gov

PC – “Slimline” 22 mm Square Single Turn Panel Control

BOURNS®

Product Dimensions

Axial PC Pins

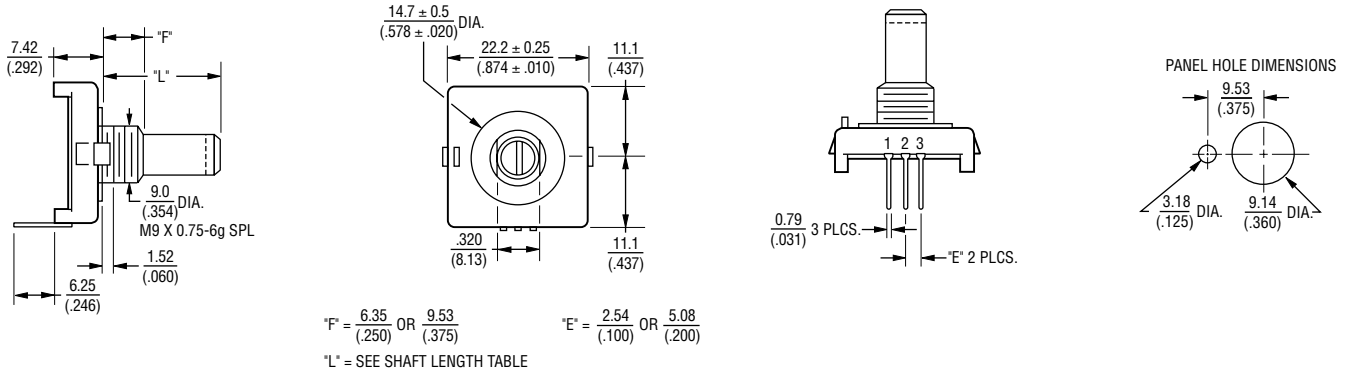

Radial PC Pins

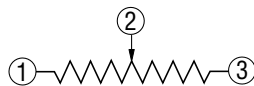
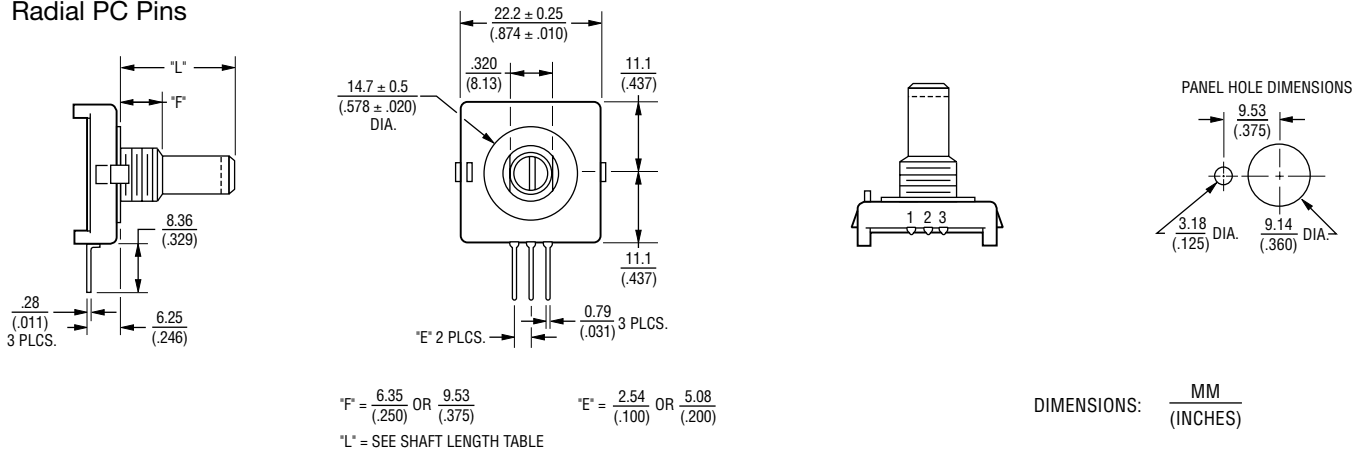

TOLERANCES EXCEPT WHERE NOTED:

.XX = ± $\frac{.25}{(0.010)}$
 .XXX = ± $\frac{.13}{(0.005)}$

Hardware

LOCKWASHER H-37-2

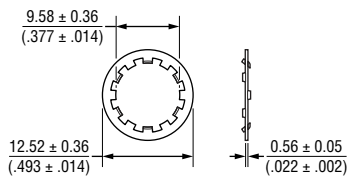

NUT H-38-11

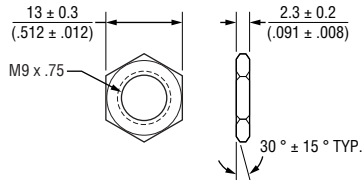

DIMENSIONS: $\frac{\text{MM}}{\text{(INCHES)}}$

Date Code Description

YY WW M

M = COUNTRY OF MANUFACTURE (MEXICO)
 WW = WEEK NUMBER
 YY = LAST TWO DIGITS OF YEAR MANUFACTURED

Specifications are subject to change without notice.

Users should verify actual device performance in their specific applications.

The products described herein and this document are subject to specific legal disclaimers as set forth on the last page of this document, and at www.bourns.com/docs/legal/disclaimer.pdf.

PC – “Slimline” 22 mm Square Single Turn Panel Control

BOURNS®

Product Dimensions

Axial PC PINS With Rear Mounting Bracket

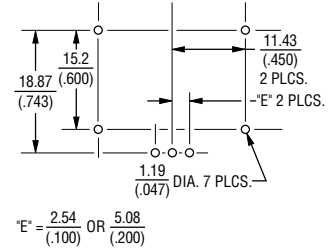
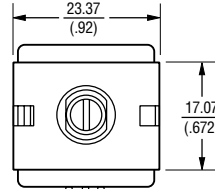
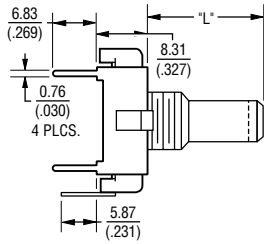

Radial PC PINS With Side Mounting Bracket

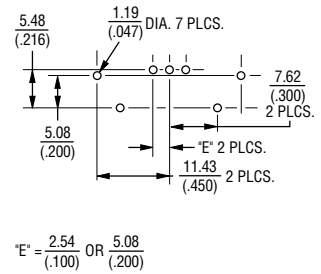
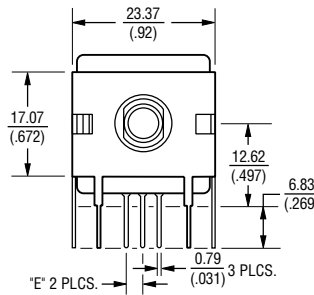
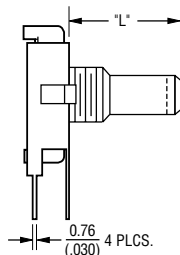

SHAFT STYLES AND ORIENTATION (Full CCW Rotation)

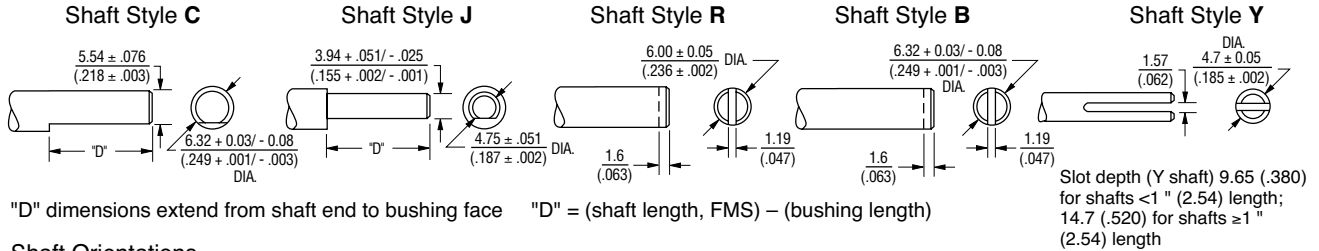

Shaft Orientations

Shaft Styles C, J

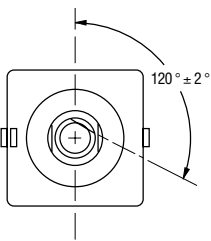

Shaft Styles B, R

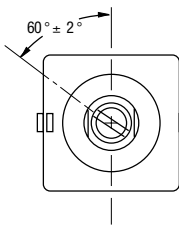

Shaft Style Y

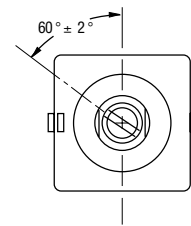

TOLERANCES EXCEPT WHERE NOTED:

.XX ± $\frac{.25}{(.010)}$
.XXX ± $\frac{.13}{(.005)}$

DIMENSIONS: $\frac{\text{MM}}{\text{(INCHES)}}$

Specifications are subject to change without notice.

Users should verify actual device performance in their specific applications.

The products described herein and this document are subject to specific legal disclaimers as set forth on the last page of this document, and at www.bourns.com/docs/legal/disclaimer.pdf.

How to Order PC "Slimline" Panel Controls



P C W 1 J - B 2 4 - B A B 1 0 3 L

SHAFT LENGTH (FMS)		
Code	Description	Available Shaft Styles
16	1/2 " (12.7 mm) Length	B
20	5/8 " (15.9 mm) Length	J
24	3/4 " (19 mm) Length	B, C, J, Y
28	7/8 " (22.2 mm) Length	B, C, J, Y
32	1 " (25.4 mm) Length	B, C, J, Y
36	1-1/8 " (28.6 mm) Length	B, C, J, Y
Metric		
19	19 mm Length	R
22	22 mm Length	R
24	24 mm Length	R

SHAFT STYLES (See Outline Drawing)	
Code	Description
B	1/4 " (6.35 mm) Dia. Slotted
C	1/4 " (6.35 mm) Dia. Flatted
J	3/16 " (4.76 mm) Dia. Flatted
R	6 mm Dia. Slotted (Use Metric Lengths Only)
Y	3/16 " (4.76 mm) Dia. Split Shaft

ANTI-ROTATION LUG	
Code	Description
J	9:00 Position
D	None

NO. SECTIONS	
Code	Description
1	Single

BUSHING CONFIGURATION		
Code	Description	Available Shaft Styles
W	9 mm x .250 " (6.35 mm) Length Threaded M9 x 0.75 6g 5 Pl	All
L	9 mm x .375 " (9.53 mm) Length Threaded M9 x 0.75 6g 5 Pl	B, C, R

RoHS IDENTIFIER	
Code	Description
L	Compliant

RESISTANCE VALUES					
Code	TR	Code	TR	Code	TR
501	500 Ω	103	10 KΩ	104	100 KΩ
102	1 KΩ	203	20 KΩ	254	250 KΩ
252	2.5 KΩ	253	25 KΩ	504	500 KΩ
502	5 KΩ	503	50 KΩ	105	1 MΩ

ELEMENT TAPER VERSIONS	
Code	Taper Description
B	Lin. CP ±20 %
D	CW Audio CP ±20 %
G	CCW Audio CP ±20 %

DETENT CONFIGURATIONS	
Code	Taper Description
A	No Detents
B	10 Detents
C	Center Detent Only
D	20 Detents
E	30 Detents
F	CCW Detent Only

Features	HOUSING TERMINAL CONFIGURATION												
	A	B	D	E	F	G	H	J	K	L	M	N	
Rear Mounting Bracket		X						X	X			X	
Side Mounting Bracket				X	X					X	X	X	
Axial Terminals .100 " (2.54 mm) Centers	X	X								X			
Radial Terminals .100 " (2.54 mm) Centers			X	X							X		
Radial Terminals .200 " (5.08 mm) Centers					X	X						X	
Solder Lugs .200" (5.08 mm) Centers		X											
Axial Terminals .200 " (5.08 mm) Centers							X	X				X	
Hardware Included	X	X	X	X	X	X	X	X	X	X	X	X	

Panel mount hardware not included as standard on bracketed versions. The sample part number demonstrates the identification code for Bourns Slimline Potentiometers. The part number shown is a commonly used model, typically available from stock.

Boldface features are Bourns standard options. All others are available with higher minimum order quantities.



Asia-Pacific: Tel: +886-2 2562-4117 • Email: asiacus@bourns.com

EMEA: Tel: +36 88 885 877 • Email: eurocus@bourns.com

The Americas: Tel: +1-951 781-5500 • Email: americus@bourns.com

www.bourns.com

REV. 07/21

Specifications are subject to change without notice.

Users should verify actual device performance in their specific applications.

The products described herein and this document are subject to specific legal disclaimers as set forth on the last page of this document, and at www.bourns.com/docs/legal/disclaimer.pdf.