

# PD30ETB20xxIS



## Photoelectrics, Background Suppression reflective with IR light



### Main features

- Miniature sensor range
- Range: 200 mm
- Sensitivity adjustment by potentiometer
- Modulated, infrared light 850 nm
- Supply voltage: 10 to 30 VDC
- Output: 100 mA, NPN or PNP preset
- Make and break switching function
- LED indication for output, stability and power ON
- Protection: reverse polarity, short circuit and transients
- Cable and plug versions
- Excellent EMC performance
- The invisible infrared light beam eliminates discomfort for people working near the sensor
- Power supply necessary only on one side of the application
- Ecolab

### Description

The PD30ET... stainless steel sensors are built with high-quality materials and designed for harsh environments.

They are designed for use in environments where high-pressure cleaning, cleaning agents and disinfectants are used on a daily basis.

The strong stainless steel (AISI316L) together with high-quality plastic materials like PEEK, PPSU, and PES sealings of FKM ensure a safe and excellent mechanical resistance.

The compact sensor design is ideally suited to confined spaces.

### Main functions

- Detects presence or absence of objects by cutting off the background information.
- The detection distance is very independent of the colour of the object to detect.



Fig. 1 Cable

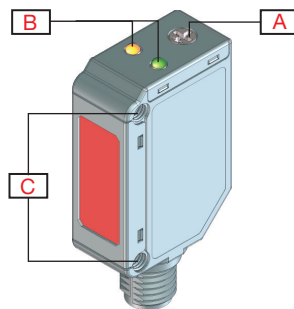

Fig. 2 Plug

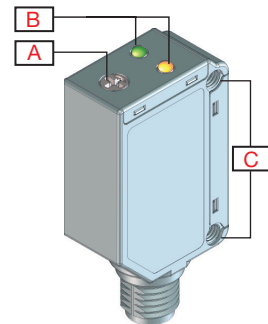

Fig. 3 Back

Element	Component	Function
A	Potentiometer	Adjustment
B	2 LEDs	Green LED: Power ON / Signal stability. Yellow LED: Output
C	2 M3	Fixing holes for sensor mounting



# Sensing

## Detection

<b>Rated operating distance (S<sub>n</sub>)</b>	≤ 200 mm	Reference target, white paper with 90 % reflectivity, Size 200x200 mm
<b>Maximum detection distance</b>	< 200 mm	White object 90% reflection
	< 200 mm	Grey object 18% reflection
	< 200 mm	Black object 6% reflection
<b>Sensitivity adjustment</b>	25 mm ... 200 mm	Single-turn potentiometer
	210°	Electrical adjustment
	240°	Mechanical adjustment
<b>Blind zone</b>	≤ 10 mm	White object 90% reflection
	≤ 12 mm	Grey object 18% reflection
	≤ 14 mm	Black object 6% reflection
<b>Hysteresis</b>	≤ 10%	
<b>Light source</b>	850 nm	Infrared
<b>Light type</b>	Infrared modulated	
<b>Detection angle</b>	± 1.1°	@100 mm (half sensing distance)
<b>Light spot size</b>	4.5 mm	@100 mm (half sensing distance)
<b>Emitter beam angle</b>	± 1.3°	@100 mm (half sensing distance)

## Accuracy

<b>Temperature drift</b>	≤ 0.05%/°C
--------------------------	------------

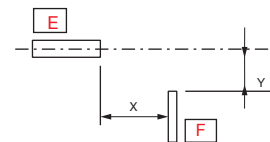
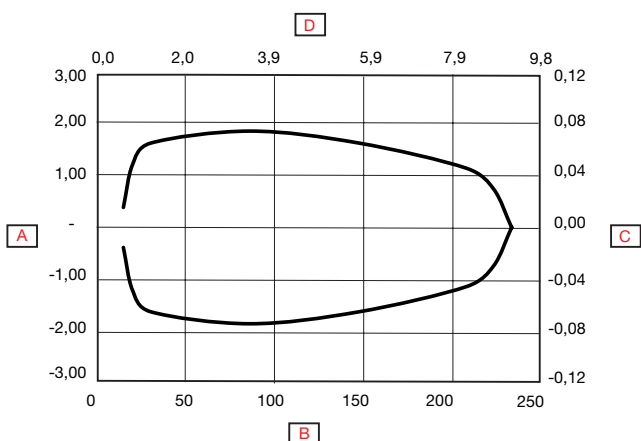

## Detection diagram

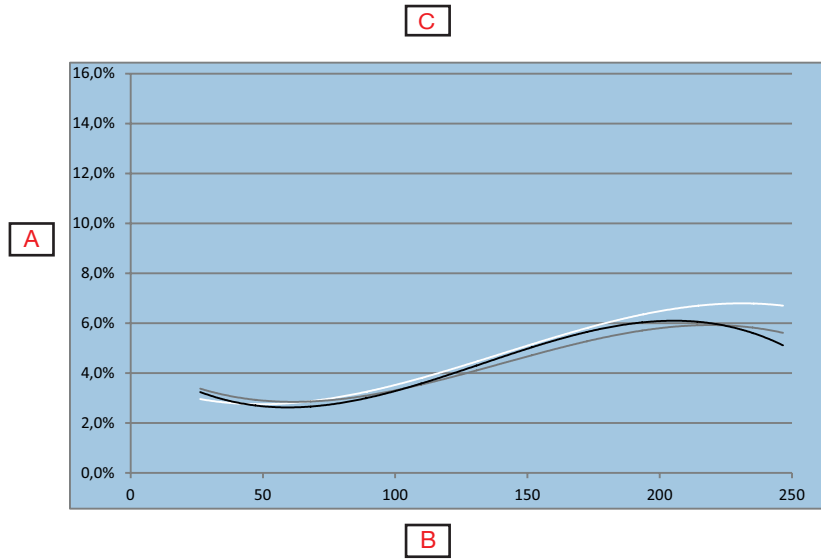

<b>A</b>	Detection width (mm)	<b>E</b>	Sensor
<b>B</b>	Sensing range (mm)	<b>F</b>	Object
<b>C</b>	Detection width (inches)		
<b>D</b>	Sensing range (inches)		

**Sensing conditions**



<b>A</b>	Distance from background (%)		Poly. (Black on white 6%/90%)
<b>B</b>	White background 90% (mm)		Poly. (Grey on white 18%/90%)
<b>C</b>	White background 90% (inches)		Poly. (White on white 90%/90%)



# Features

## Power Supply

Rated operational voltage ( $U_B$ )	10 ... 30 VDC (ripple included)
Ripple ( $U_{rpp}$ )	$\leq 10\%$
No load supply current ( $I_o$ )	$\leq 40$ mA @ $U_B$ min $\leq 20$ mA @ $U_B$ max
Power-ON delay ( $t_v$ )	$\leq 200$ ms

## Outputs

Output functions	NPN or PNP by sensor type	Open collector
Output switching function	N.O. and N.C.	
Output current	$< 100$ mA	Continuous( $I_e$ )
	$\leq 100$ mA @ 100 nF load	Short-time (I)
Minimum operational current ( $I_m$ )	0.5 mA	
OFF-state current( $I_r$ )	100 $\mu$ A	
Voltage drop ( $U_d$ )	2 VDC @ ( $I_e$ ) max.	
Protection	Short circuit, reverse polarity and transients	
Utilization category	DC-12	Control of resistive loads and solid-state loads with optical isolation
	DC-13	Control of electromagnets

## Operation diagram

$T_v$  = Power-ON delay



## Response times

Operating frequency (f)	$\leq 500$ Hz	
Response times	$\leq 1.0$ ms	OFF-ON ( $t_{ON}$ )
	$\leq 1.0$ ms	ON-OFF ( $t_{ON}$ )



**Indication**

Green LED	Yellow LED	Power	Output
ON	OFF	ON	OFF
OFF	OFF	OFF	-
ON	ON	ON	ON

**Environmental**

<b>Ambient temperature</b>	-25° ... +60°C (-13° ... +140°F)	Operating <sup>1)</sup>
	-40° ... +70°C (-40° ... +158°F)	Storage <sup>1)</sup>
<b>Ambient light</b>	≤ 65 000 lux	@ 3000 ... 3200 °K
<b>Vibration</b>	10 ... 150 Hz, 1.0 mm/15 g	EN 60068-2-6
<b>Shock</b>	30 gn / 11ms, 6 pos, 6 neg per axis	EN60068-2-27
<b>Drop test</b>	2 x 1 m and 100 x 0.5 m	EN 60068-2-31
<b>Rated insulation voltage (U<sub>i</sub>)</b>	50 VDC	
<b>Dielectric insulation voltage</b>	≥ 500 VAC rms	50/60 Hz for 1 min.
<b>Rated impulse withstand voltage</b>	1 kV	1.2/50 μs
<b>Pollution degree</b>	3	EN60947-1
<b>Overvoltage category</b>	III	IEC60664; EN60947-1
<b>Degree of protection</b>	IP68 @ 2m and 20 h	IEC60539; EN60947-1
	IP69K	DIN 40050-9
<b>NEMA Enclosure Types</b>	1, 2, 4, 4x, 5, 6, 6P	NEMA 250
<b>Ambient humidity range</b>	35% ... 95%	Operating <sup>2)</sup>
	35% ... 95%	Storage <sup>2)</sup>

<sup>1)</sup> Do not bend the cable in temperatures below -10°C

<sup>2)</sup> With no icing or condensation

**EMC**

<b>Electrostatic discharge immunity test</b>	± 8 kV @ air discharge or ± 4 kV @ contact discharge	IEC 61000-4-2
<b>Radiated radio-frequency electromagnetic field immunity test (80 MHz ... 1 GHz and 1..4 GHz ... 2 GHz)</b>	10 V/m	IEC 61000-4-3
<b>Electrical fast transient/Burst immunity test</b>	2 kV / 5 kHz using the capacitive coupling clamp	IEC 61000-4-4
<b>Conducted disturbances induced by radio-frequency fields immunity test (150 kHz ... 80 MHz)</b>	10 Vrms	IEC 61000-4-6
<b>Power frequency magnetic field immunity test</b>	30 A/m 38 μT	IEC 61000-4-8

## Mechanics/electronics

### ▶ Connection

<b>Cable</b>	2 m, 4-wire 4 x 0.14 mm <sup>2</sup> , Ø = 3.3 mm, PVC, Black
<b>Plug</b>	M8, 4-pin, male

### ▶ Wiring

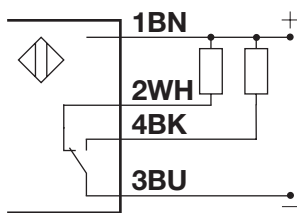

Fig. 4 NPN

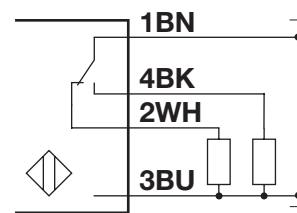

Fig. 5 PNP

Colour code							
<b>BN</b>	Brown	<b>WH</b>	White	<b>BK</b>	Black	<b>BU</b>	Blue

### ▶ Housing

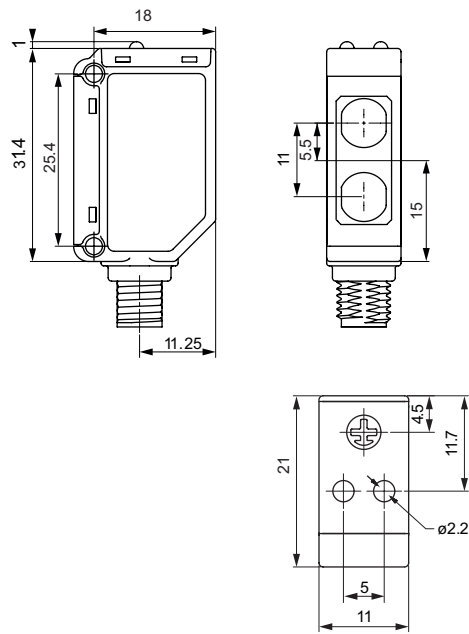
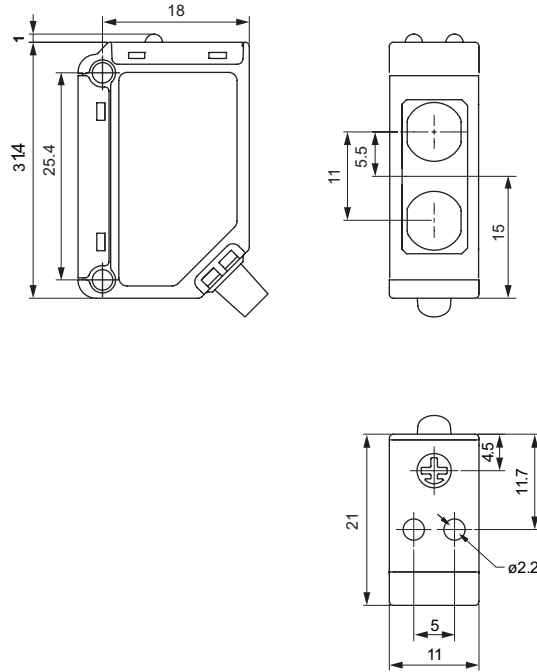

<b>Body</b>	Stainless steel, AISI316L	
<b>Front glass</b>	PPSU, Red	
<b>Trimmer shaft</b>	PEEK, Light grey	
<b>Indication</b>	PES, Transparent	Polyethersulfone
<b>Sealing</b>	FKM	Fluoroelastomer
<b>Cable gland</b>	FKM	Fluoroelastomer
<b>Dimensions</b>	11 x 31.5 x 21 mm	
<b>Weight</b>	≤ 100 g	Cable version
	≤ 65 g	Plug version

Dimensions



## Compatibility and conformity

### ▶ Approvals and markings

<b>General reference</b>	Sensor designed according to EN60947-5-2	
<b>MTTF<sub>d</sub></b>	180.8 years @ 40°C (+104°F)	ISO 13849-1, SN 29500
<b>CE-marking</b>		
<b>Approvals</b>	 (UL508 + C22.2)	
<b>Other Approvals</b>		Topax 56, Topaz AC1, Topaz MD3, Topaz CL1, Topactiv OKTO, P3-hypochloran





## References

**Product selection key**

PD30ETB20  A  IS

Enter the code option instead of

Code	Option	Description
P	-	Photoelectric sensor
D	-	Rectangular housing
30	-	Length of housing
E	-	Stainless steel
T	-	Top trimmer
B	-	Diffuse reflective, Background suppression
20	-	Distance [cm]
<input type="checkbox"/>	N	NPN
	P	PNP
A	-	Output: N.O. and N.C.
<input type="checkbox"/>	-	Cable, 2 m
	M5	Connector M8
IS	-	Sensitivity adjustment and infrared light

**Type selection**

Conne- ction	Output	Code
Cable	NPN	PD30ETB20NAIS
	PNP	PD30ETB20PAIS
Plug	NPN	PD30ETB20NAM5IS
	PNP	PD30ETB20PAM5IS