

PD30ETB20xxIS



Photoelectrics, Background Suppression reflective with IR light



Main features

- Miniature sensor range
- Range: 200 mm
- Sensitivity adjustment by potentiometer
- Modulated, infrared light 850 nm
- Supply voltage: 10 to 30 VDC
- Output: 100 mA, NPN or PNP preset
- Make and break switching function
- LED indication for output, stability and power ON
- Protection: reverse polarity, short circuit and transients
- Cable and plug versions
- Excellent EMC performance
- The invisible infrared light beam eliminates discomfort for people working near the sensor
- Power supply necessary only on one side of the application
- Ecolab

Description

The PD30ET... stainless steel sensors are built with high-quality materials and designed for harsh environments.

They are designed for use in environments where high-pressure cleaning, cleaning agents and disinfectants are used on a daily basis.

The strong stainless steel (AISI316L) together with high-quality plastic materials like PEEK, PPSU, and PES sealings of FKM ensure a safe and excellent mechanical resistance.

The compact sensor design is ideally suited to confined spaces.

Main functions

- Detects presence or absence of objects by cutting off the background information.
- The detection distance is very independent of the colour of the object to detect.



Fig. 1 Cable

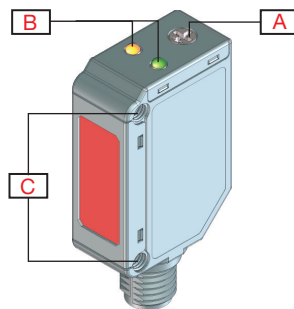

Fig. 2 Plug

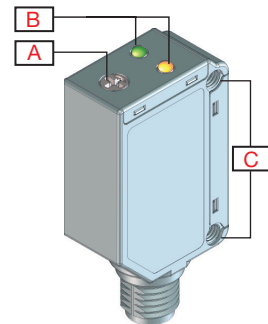

Fig. 3 Back

Element	Component	Function
A	Potentiometer	Adjustment
B	2 LEDs	Green LED: Power ON / Signal stability. Yellow LED: Output
C	2 M3	Fixing holes for sensor mounting



Sensing

Detection

Rated operating distance (S_n)	≤ 200 mm	Reference target, white paper with 90 % reflectivity, Size 200x200 mm
Maximum detection distance	< 200 mm	White object 90% reflection
	< 200 mm	Grey object 18% reflection
	< 200 mm	Black object 6% reflection
Sensitivity adjustment	25 mm ... 200 mm	Single-turn potentiometer
	210°	Electrical adjustment
	240°	Mechanical adjustment
Blind zone	≤ 10 mm	White object 90% reflection
	≤ 12 mm	Grey object 18% reflection
	≤ 14 mm	Black object 6% reflection
Hysteresis	≤ 10%	
Light source	850 nm	Infrared
Light type	Infrared modulated	
Detection angle	± 1.1°	@100 mm (half sensing distance)
Light spot size	4.5 mm	@100 mm (half sensing distance)
Emitter beam angle	± 1.3°	@100 mm (half sensing distance)

Accuracy

Temperature drift	≤ 0.05%/°C
--------------------------	------------

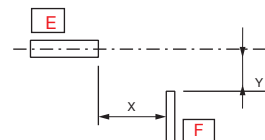
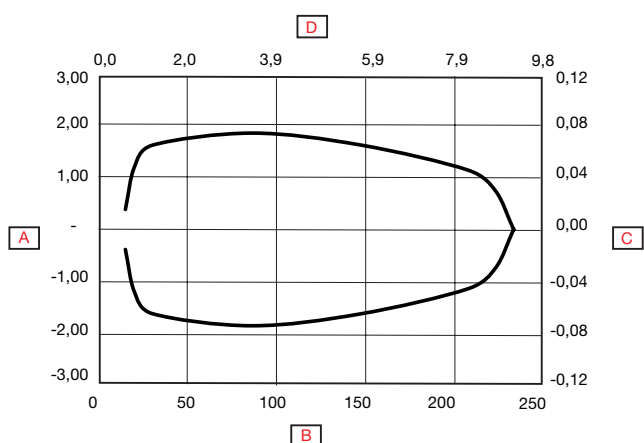

Detection diagram

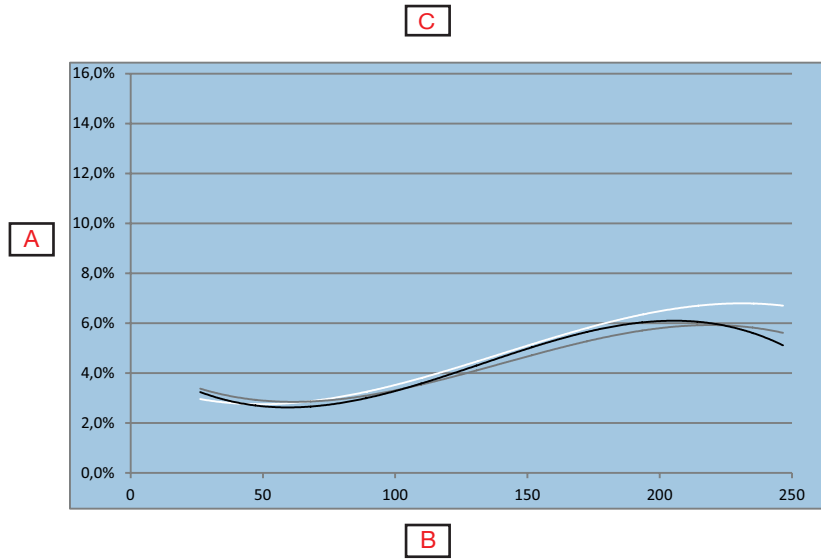

A	Detection width (mm)	E	Sensor
B	Sensing range (mm)	F	Object
C	Detection width (inches)		
D	Sensing range (inches)		

Sensing conditions



A	Distance from background (%)		Poly. (Black on white 6%/90%)
B	White background 90% (mm)		Poly. (Grey on white 18%/90%)
C	White background 90% (inches)		Poly. (White on white 90%/90%)



Features

Power Supply

Rated operational voltage (U_B)	10 ... 30 VDC (ripple included)
Ripple (U_{rpp})	$\leq 10\%$
No load supply current (I_o)	≤ 40 mA @ U_B min ≤ 20 mA @ U_B max
Power-ON delay (t_v)	≤ 200 ms

Outputs

Output functions	NPN or PNP by sensor type	Open collector
Output switching function	N.O. and N.C.	
Output current	< 100 mA	Continuous(I_e)
	≤ 100 mA @ 100 nF load	Short-time (I)
Minimum operational current (I_m)	0.5 mA	
OFF-state current(I_r)	100 μ A	
Voltage drop (U_d)	2 VDC @ (I_e) max.	
Protection	Short circuit, reverse polarity and transients	
Utilization category	DC-12	Control of resistive loads and solid-state loads with optical isolation
	DC-13	Control of electromagnets

Operation diagram

T_v = Power-ON delay



Response times

Operating frequency (f)	≤ 500 Hz	
Response times	≤ 1.0 ms	OFF-ON (t_{ON})
	≤ 1.0 ms	ON-OFF (t_{ON})



Indication

Green LED	Yellow LED	Power	Output
ON	OFF	ON	OFF
OFF	OFF	OFF	-
ON	ON	ON	ON

Environmental

Ambient temperature	-25° ... +60°C (-13° ... +140°F)	Operating ¹⁾
	-40° ... +70°C (-40° ... +158°F)	Storage ¹⁾
Ambient light	≤ 65 000 lux	@ 3000 ... 3200 °K
Vibration	10 ... 150 Hz, 1.0 mm/15 g	EN 60068-2-6
Shock	30 gn / 11ms, 6 pos, 6 neg per axis	EN60068-2-27
Drop test	2 x 1 m and 100 x 0.5 m	EN 60068-2-31
Rated insulation voltage (U_i)	50 VDC	
Dielectric insulation voltage	≥ 500 VAC rms	50/60 Hz for 1 min.
Rated impulse withstand voltage	1 kV	1.2/50 μs
Pollution degree	3	EN60947-1
Overvoltage category	III	IEC60664; EN60947-1
Degree of protection	IP68 @ 2m and 20 h	IEC60539; EN60947-1
	IP69K	DIN 40050-9
NEMA Enclosure Types	1, 2, 4, 4x, 5, 6, 6P	NEMA 250
Ambient humidity range	35% ... 95%	Operating ²⁾
	35% ... 95%	Storage ²⁾

¹⁾ Do not bend the cable in temperatures below -10°C

²⁾ With no icing or condensation

EMC

Electrostatic discharge immunity test	± 8 kV @ air discharge or ± 4 kV @ contact discharge	IEC 61000-4-2
Radiated radio-frequency electromagnetic field immunity test (80 MHz ... 1 GHz and 1..4 GHz ... 2 GHz)	10 V/m	IEC 61000-4-3
Electrical fast transient/Burst immunity test	2 kV / 5 kHz using the capacitive coupling clamp	IEC 61000-4-4
Conducted disturbances induced by radio-frequency fields immunity test (150 kHz ... 80 MHz)	10 Vrms	IEC 61000-4-6
Power frequency magnetic field immunity test	30 A/m 38 μT	IEC 61000-4-8

Mechanics/electronics

▶ Connection

Cable	2 m, 4-wire 4 x 0.14 mm ² , Ø = 3.3 mm, PVC, Black
Plug	M8, 4-pin, male

▶ Wiring

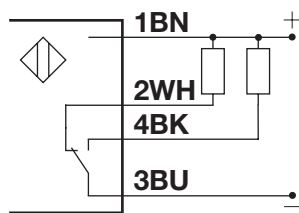

Fig. 4 NPN

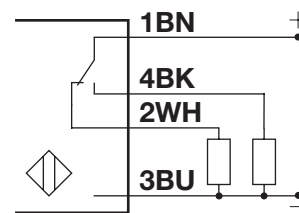

Fig. 5 PNP

Colour code							
BN	Brown	WH	White	BK	Black	BU	Blue

▶ Housing

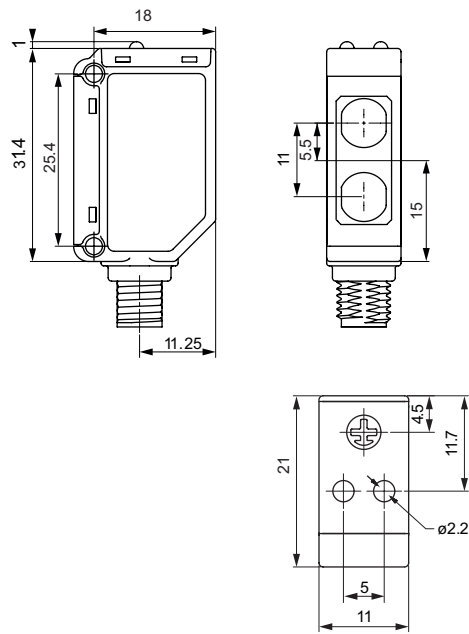
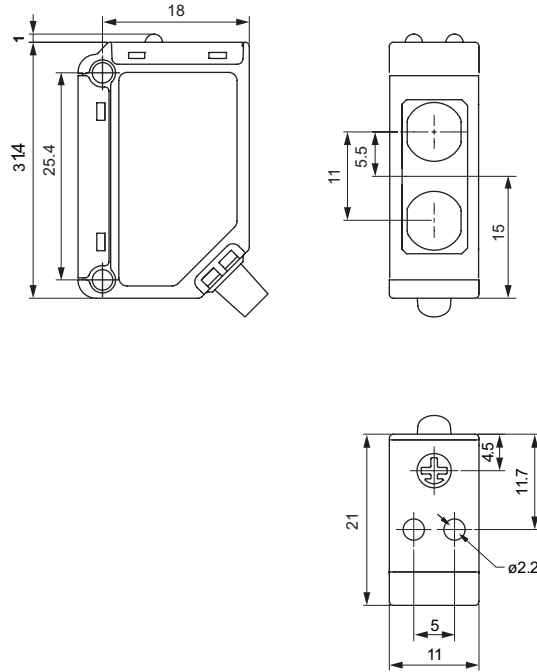

Body	Stainless steel, AISI316L	
Front glass	PPSU, Red	
Trimmer shaft	PEEK, Light grey	
Indication	PES, Transparent	Polyethersulfone
Sealing	FKM	Fluoroelastomer
Cable gland	FKM	Fluoroelastomer
Dimensions	11 x 31.5 x 21 mm	
Weight	≤ 100 g	Cable version
	≤ 65 g	Plug version

Dimensions



Compatibility and conformity

▶ Approvals and markings

General reference	Sensor designed according to EN60947-5-2	
MTTF_d	180.8 years @ 40°C (+104°F)	ISO 13849-1, SN 29500
CE-marking		
Approvals	 (UL508 + C22.2)	
Other Approvals		Topax 56, Topaz AC1, Topaz MD3, Topaz CL1, Topactiv OKTO, P3-hypochloran



References

Product selection key

PD30ETB20 A IS

Enter the code option instead of

Code	Option	Description
P	-	Photoelectric sensor
D	-	Rectangular housing
30	-	Length of housing
E	-	Stainless steel
T	-	Top trimmer
B	-	Diffuse reflective, Background suppression
20	-	Distance [cm]
<input type="checkbox"/>	N	NPN
	P	PNP
A	-	Output: N.O. and N.C.
<input type="checkbox"/>	-	Cable, 2 m
	M5	Connector M8
IS	-	Sensitivity adjustment and infrared light

Type selection

Conne- ction	Output	Code
Cable	NPN	PD30ETB20NAIS
	PNP	PD30ETB20PAIS
Plug	NPN	PD30ETB20NAM5IS
	PNP	PD30ETB20PAM5IS