

# PD30ETP60xxSA



## Photoelectrics, Polarized retro-reflective



### Main features

- Miniature sensor range
- Sensing range: 6 m
- Sensitivity adjustment by potentiometer
- Modulated, red light 625 nm
- Supply voltage: 10 to 30 VDC
- Output: 100 mA, NPN or PNP preset
- Make and break switching function
- LED indication for output, stability and power ON
- Protection: reverse polarity, short circuit and transients
- Cable and plug versions
- Excellent EMC performance
- Easy mounting since only the sensor must be aligned with the reflector
- Power supply necessary only on one side of the application
- Ecolab

### Description

The PD30ET... stainless steel sensors are built with high-quality materials and designed for harsh environments.

They are designed for use in environments where high-pressure cleaning, cleaning agents and disinfectants are used on a daily basis.

The strong stainless steel (AISI316L) together with high-quality plastic materials like PEEK, PPSU, and PES sealings of FKM ensure a safe and excellent mechanical resistance.

The compact sensor design is ideally suited to confined spaces.

### Main functions

- Detects presence or absence of objects that cut off light reflected from a reflector
- The polarized light makes it possible to detect highly reflecting objects



Fig. 1 Cable

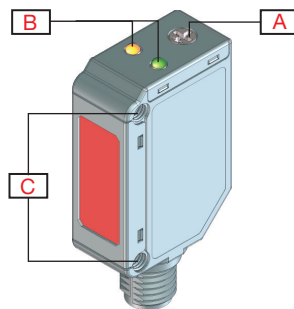

Fig. 2 Plug

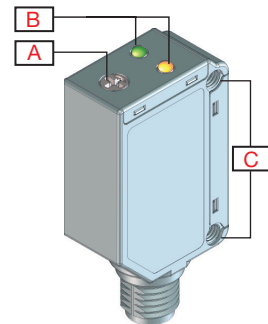

Fig. 3 Back

Element	Component	Function
A	Potentiometer	Adjustment
B	2 LEDs	Green LED: Power ON / Signal stability. Yellow LED: Output
C	2 M3	Fixing holes for sensor mounting



# Sensing

## Detection

<b>Rated operating distance (S<sub>n</sub>)</b>	≤ 6 m	@ Reference target, reflector: ER4 (Ø80 mm)
	≤ 4 m	@ Reference target, reflector: ER4060
<b>Sensitivity adjustment</b>	1.7 ... 6 m	Single-turn potentiometer
	210°	Electrical adjustment
	240°	Mechanical adjustment
<b>Blind zone</b>	≤ 100 mm @ S <sub>n</sub> max	@ Reference target, reflector: ER4 (Ø80 mm) or ER4060
<b>Hysteresis</b>	3% ... 20%	
<b>Light source</b>	625 nm	Red
<b>Light type</b>	Red modulated	
<b>Detection angle</b>	± 1.3°	@ 3.0 m (half sensing distance)
<b>Light spot size</b>	15 cm	@ 3.0 m (half sensing distance)
<b>Emitter beam angle</b>	± 1.4°	@ 3.0 m (half sensing distance)

## Accuracy

<b>Temperature drift</b>	≤ 0.2%/°C
--------------------------	-----------

## Detection diagram

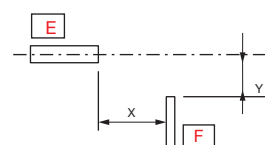
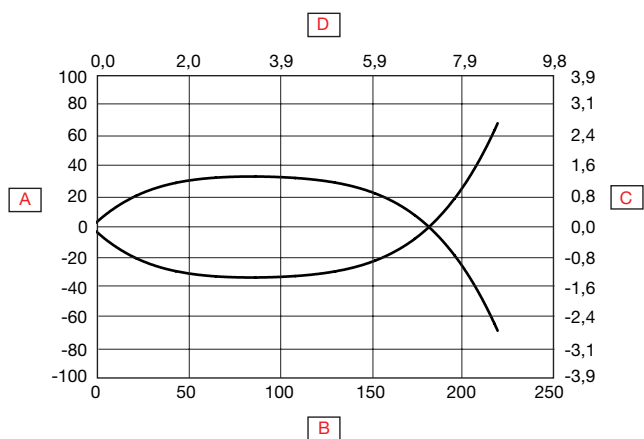

<b>A</b>	Detection width (mm)	<b>E</b>	Sensor
<b>B</b>	Sensing range (mm)	<b>F</b>	ER4 reflector
<b>C</b>	Detection width (inches)		
<b>D</b>	Sensing range (inches)		



**Excess gain**

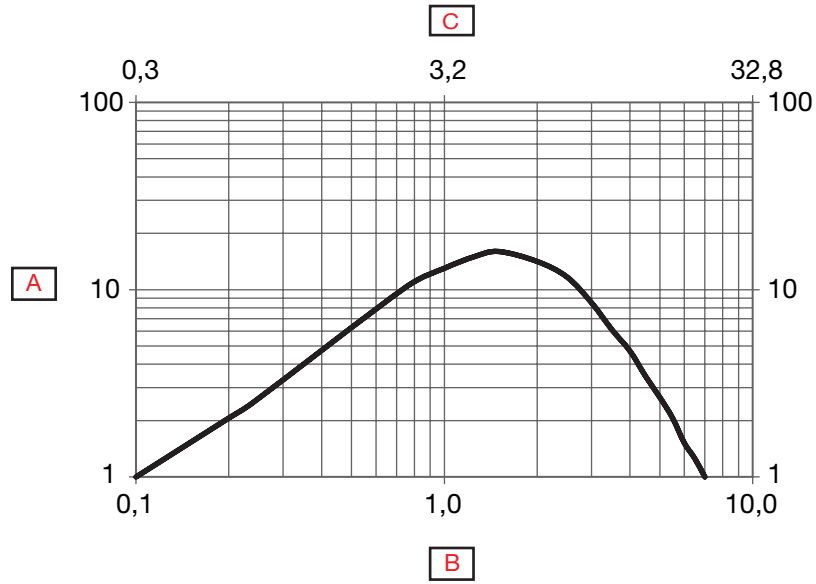

<b>A</b>	Excess gain	<b>C</b>	Distance (feet)
<b>B</b>	Distance (m)		



# Features

## Power Supply

Rated operational voltage ( $U_B$ )	10 ... 30 VDC (ripple included)
Ripple ( $U_{rpp}$ )	$\leq 10\%$
No load supply current ( $I_o$ )	$\leq 25$ mA @ $U_B$ max
Power-ON delay ( $t_v$ )	$\leq 30$ ms

## Outputs

Output functions	NPN or PNP by sensor type	Open collector
Output switching function	N.O. and N.C.	
Output current	$< 100$ mA	Continuous( $I_e$ )
	$\leq 100$ mA @ 100 nF load	Short-time (I)
Minimum operational current ( $I_m$ )	0.5 mA	
OFF-state current( $I_r$ )	100 $\mu$ A	
Voltage drop ( $U_d$ )	2 VDC @ ( $I_e$ ) max.	
Protection	Short circuit, reverse polarity and transients	
Utilization category	DC-12	Control of resistive loads and solid-state loads with optical isolation
	DC-13	Control of electromagnets

## Operation diagram

$T_v$  = Power-ON delay

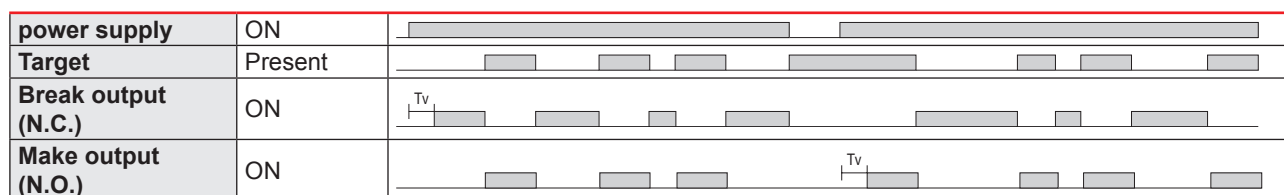

## Response times

Operating frequency (f)	$\leq 1000$ Hz	
Response times	$\leq 0.5$ ms	OFF-ON ( $t_{ON}$ )
	$\leq 0.5$ ms	ON-OFF ( $t_{ON}$ )



**Indication**

Green LED	Yellow LED	Power	Output
ON	OFF	ON	OFF (stable)*
OFF	OFF	ON or OFF	OFF
OFF	ON	ON	ON
ON	ON	ON	ON (stable)*

\*See signal stability curve

**Signal stability indication**

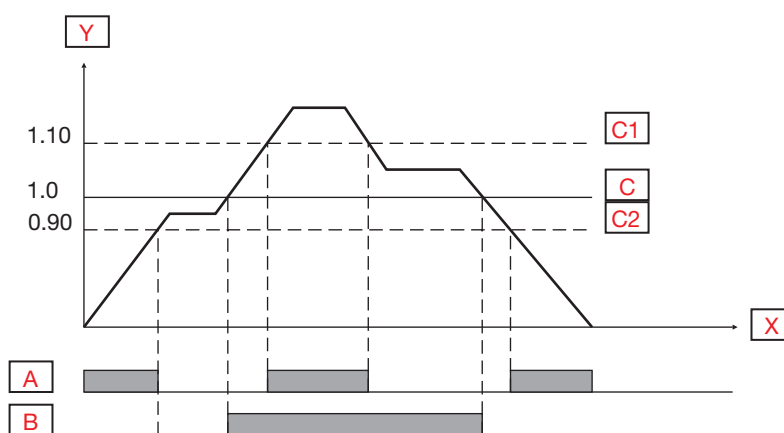

A	Green LED ON	C1	Operation level x 1.10
B	Yellow LED OFF	C	Operation level
X	Time	C2	Operation level x 0.90
Y	Excess gain		

**Environmental**

Ambient temperature	-25° ... +60°C (-13° ... +140°F)	Operating, Cable version <sup>1)</sup>
	-40° ... +60°C (-40° ... +140°F)	Operating, Plug version <sup>1)</sup>
	-40° ... +70°C (-40° ... +158°F)	Storage <sup>1)</sup>
Ambient light	≤ 65 000 lux	@ 3000 ... 3200 °K
Vibration	10 ...150 Hz, 1.0 mm/15 g	EN 60068-2-6
Shock	30 g <sub>n</sub> / 11ms, 6 pos, 6 neg per axis	EN60068-2-27
Drop test	2 x 1 m and 100 x 0.5 m	EN 60068-2-31
Rated insulation voltage (U <sub>i</sub> )	50 VDC	
Dielectric insulation voltage	≥ 500 VAC rms	50/60 Hz for 1 min.
Rated impulse withstand voltage	1 kV	1.2/50 μs
Pollution degree	3	EN60947-1
Overvoltage category	III	IEC60664; EN60947-1
Degree of protection	IP68 @ 2m and 20 h	IEC60539; EN60947-1
	IP69K	DIN 40050-9
NEMA Enclosure Types	1, 2, 4, 4x, 5, 6, 6P	NEMA 250
Ambient humidity range	35% ... 95%	Operating <sup>2)</sup>
	35% ... 95%	Storage <sup>2)</sup>



- 1) Do not bend the cable in temperatures below -10°C
- 2) With no icing or condensation

**EMC**

<b>Electrostatic discharge immunity test</b>	± 8 kV @ air discharge or ± 4 kV @ contact discharge	IEC 61000-4-2
<b>Radiated radio-frequency electromagnetic field immunity test (80 MHz ... 1 GHz and 1.4 GHz ... 2 GHz)</b>	10 V/m	IEC 61000-4-3
<b>Electrical fast transient/Burst immunity test</b>	2 kV / 5 kHz using the capacitive coupling clamp	IEC 61000-4-4
<b>Conducted disturbances induced by radio-frequency fields immunity test (150 kHz ... 80 MHz)</b>	10 Vrms	IEC 61000-4-6
<b>Power frequency magnetic field immunity test</b>	30 A/m 38 µT	IEC 61000-4-8

## Mechanics/electronics

### ▶ Connection

<b>Cable</b>	2 m, 4-wire 4 x 0.14 mm <sup>2</sup> , Ø = 3.3 mm, PVC, Black
<b>Plug</b>	M8, 4-pin, male

### ▶ Wiring

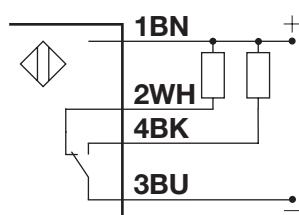

Fig. 4 NPN

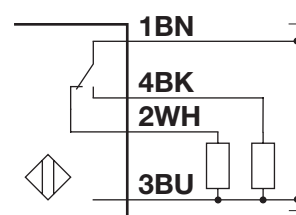

Fig. 5 PNP

Colour code							
<b>BN</b>	Brown	<b>WH</b>	White	<b>BK</b>	Black	<b>BU</b>	Blue

### ▶ Housing

<b>Body</b>	Stainless steel, AISI316L	
<b>Front glass</b>	PMMA, Organosiloxane Coated	
<b>Trimmer shaft</b>	PEEK, Light grey	
<b>Indication</b>	PES, Transparent	Polyethersulfone
<b>Sealing</b>	FKM	Fluoroelastomer
<b>Cable gland</b>	FKM	Fluoroelastomer
<b>Dimensions</b>	11 x 31.5 x 21 mm	
<b>Weight</b>	≤ 100 g	Cable version
	≤ 65 g	Plug version

**Dimensions**

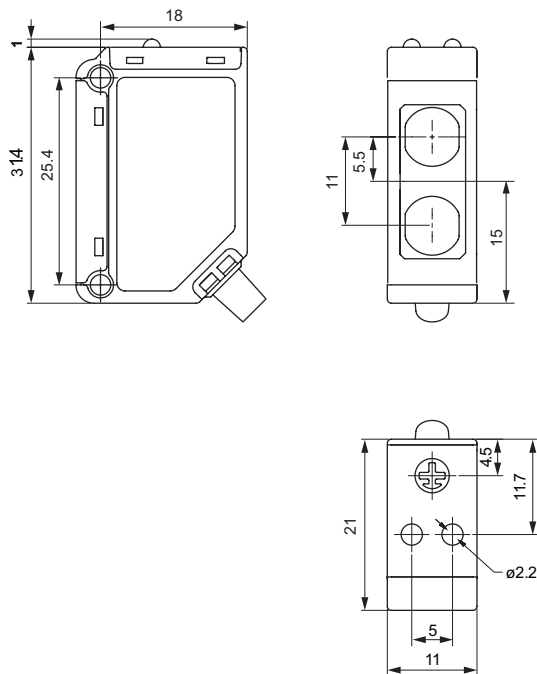

**Fig. 6 Cable**

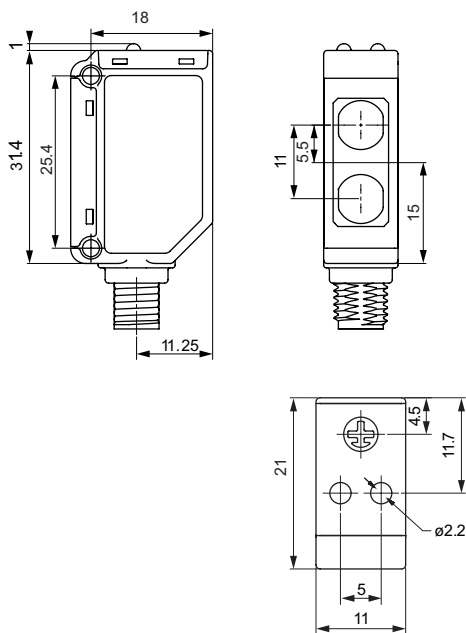



**Fig. 7 Plug**





## Compatibility and conformity

### ▶ Approvals and markings

<b>General reference</b>	Sensor designed according to EN60947-5-2	
<b>MTTF<sub>d</sub></b>	176.5 years @ 40°C (+104°F)	ISO 13849-1, SN 29500
<b>CE-marking</b>		
<b>Approvals</b>	 (UL508 + C22.2)	
<b>Other Approvals</b>		Topax 56, Topaz AC1, Topaz MD3, Topaz CL1, Topactiv OKTO, P3-hypochloran



## References

### Product selection key

PD30ETP60  A  SA

Enter the code option instead of

Code	Option	Description
P	-	Photoelectric sensor
D	-	Rectangular housing
30	-	Length of housing
E	-	Stainless steel
T	-	Top trimmer
P	-	Polarized retro-reflective
60	-	Distance [dm]
<input type="checkbox"/>	N	NPN
	P	PNP
A	-	Output: N.O. and N.C.
<input type="checkbox"/>	-	Cable, 2 m
	M5	Connector M8
SA	-	Sensitivity adjustment

### Type selection

Conne- ction	Output	Code
Cable	NPN	PD30ETP60NASA
	PNP	PD30ETP60PASA
Plug	NPN	PD30ETP60NAM5SA
	PNP	PD30ETP60PAM5SA