

PoE PSE Controller

Introduction

The PD39210 is a member of the Microchip Generation 6 family of PSE controllers. The device when used with the Microchip PD39208 PSE manager is an optimized IEEE® 802.3af/at Power Sourcing Equipment (PSE) solution.

The Microchip Generation 6 family of PSE controllers includes the PD69210, PD69220, and PD39210 devices. The PD69210 and PD69220 have an identical feature set and differ only in physical pinout. The PD39210 has an identical pinout to the PD69210, with a reduced feature set. The PD69210, PD69220, and PD39210 are based on the Microchip SAM D21 family. The PD69210 and PD39210 are recommended for all new designs. The PD69220 is available for existing designs.

The PD39210 will support up to 48 2-pair logical ports and is available in a 32-pin, 5 mm × 5 mm QFN package.

Typical PoE Application

The following figure shows the typical PoE application using the PD39210 Controller and PD39208 Manager.

Figure 1. Typical IEEE 802.3af/at PoE Application

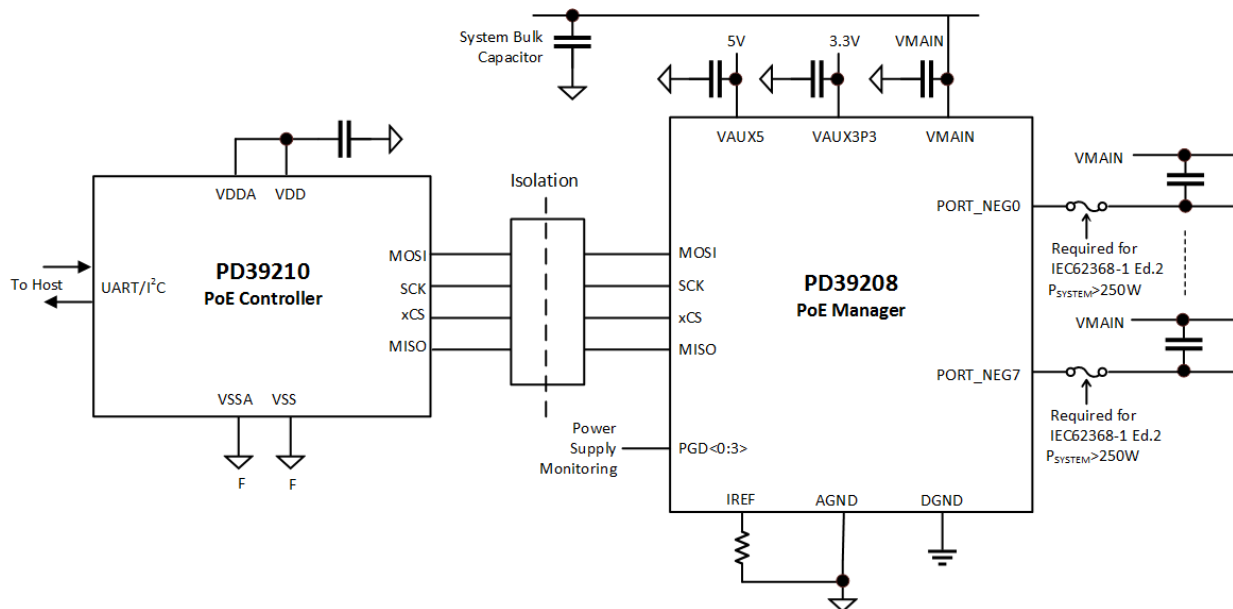

Consult Microchip AN3615 *Designing an IEEE 802.3af/at PoE System Based on PD39210 + PD39208 Chipset*.

Features Matrix

Feature	Description	PD69210	PD69220	PD39210
Support IEEE 802.3af/at		Y	Y	Y
Support IEEE 802.3bt		Y	Y	N
Support HDBaseT (POH)		Y	Y	N
Port control matrix	Port matrix control enables to ascribe each physical port in the system to a logical port.	2p/4p	2p/4p	2p
Logical ports	A logical port can be built from 2×physical ports or 1×physical port with PD69210 or PD69220. A logical port can be built from 1×physical port with PD39210.	48	48	48
Max 2-pair power		45 W	45 W	30 W
Power management	The system supports three power management modes: Class (LLDP), Dynamic, and Static.	Per port	Per port	Per system No LLDP
Power good	Used to select the system power bank to be applied to the specific PoE manager.	Y	Y	Y
Port power limit	Configurable port power limit; when a port exceeds the limit, it is automatically disconnected.	Y	Y	Y
Interrupt pin	Interrupt out from PoE controller.	Y	Y	Y
Disable port pin	Shuts down all of the PoE ports in the system.	Y	Y	Y
System OK indication	System validity indication. Provides a digital output signal to the host or to control an LED to indicate system status. When the system is OK pin state is low.	Y	Y	Y
Legacy (reduced capacitance) detection	Enables detection and powering of pre-standard devices (PDs).	Per port	Per port	Per port
LED stream	A direct SPI interface to an external LED stream.	Y	Y	Y
Fast PoE	Ability of a system to quickly boot and power up ports without waiting for the host setting.	Y	Y	Y
Perpetual PoE	Ability of a PoE system to maintain PoE power while upgrading host firmware or host is in reset.	Y	Y	Y
Communication	Communication interface with host.	I ² C or UART	I ² C or UART	I ² C or UART
Communications protocol	Compatible with previous generations controllers.	Y	Y	N
Pin-compatible with PD69200	Able to use on a PCB that was designed for the PD69200.	N	Y	N
MSL1 and RoHS		Y	Y	Y

Table of Contents

Introduction.....	1
Typical PoE Application.....	1
Features Matrix.....	2
1. Architecture.....	4
1.1. Firmware.....	4
1.2. Communication.....	4
1.3. GUI.....	4
1.4. Software Library.....	5
1.5. SPI Communication.....	5
1.6. UART	5
1.7. I ² C	5
1.8. UART or I ² C Address Selection.....	6
2. Electrical Specifications.....	7
2.1. Electrical Characteristics.....	7
2.2. Immunity.....	7
2.3. Absolute Maximum Ratings.....	7
3. Pins.....	8
3.1. Pin Diagrams.....	8
3.2. Pin Descriptions.....	9
4. Package Information.....	11
4.1. PD39210 Package Outline Drawing.....	11
4.2. Thermal Specifications.....	12
4.3. Recommended PCB Layout.....	13
4.4. Recommended Solder Reflow Information.....	15
4.5. Reference Documents.....	16
5. Ordering Information.....	17
6. Revision History.....	18
The Microchip Website.....	19
Product Change Notification Service.....	19
Customer Support.....	19
Microchip Devices Code Protection Feature.....	19
Legal Notice.....	20
Trademarks.....	20
Quality Management System.....	21
Worldwide Sales and Service.....	22

1. Architecture

The following figures show the simplified hardware architecture and firmware architecture of the PoE system based on the PD39210 controller and PD39208 manager.

Figure 1-1. Simplified Hardware Architecture

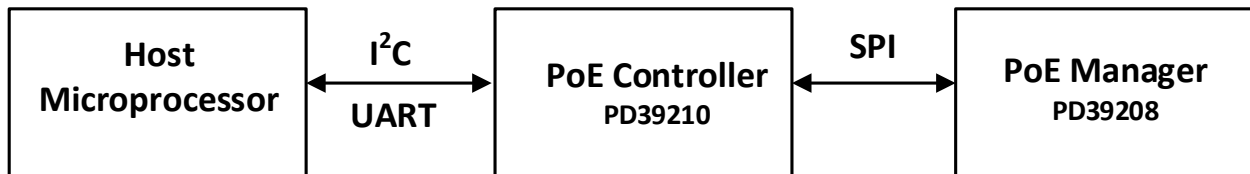
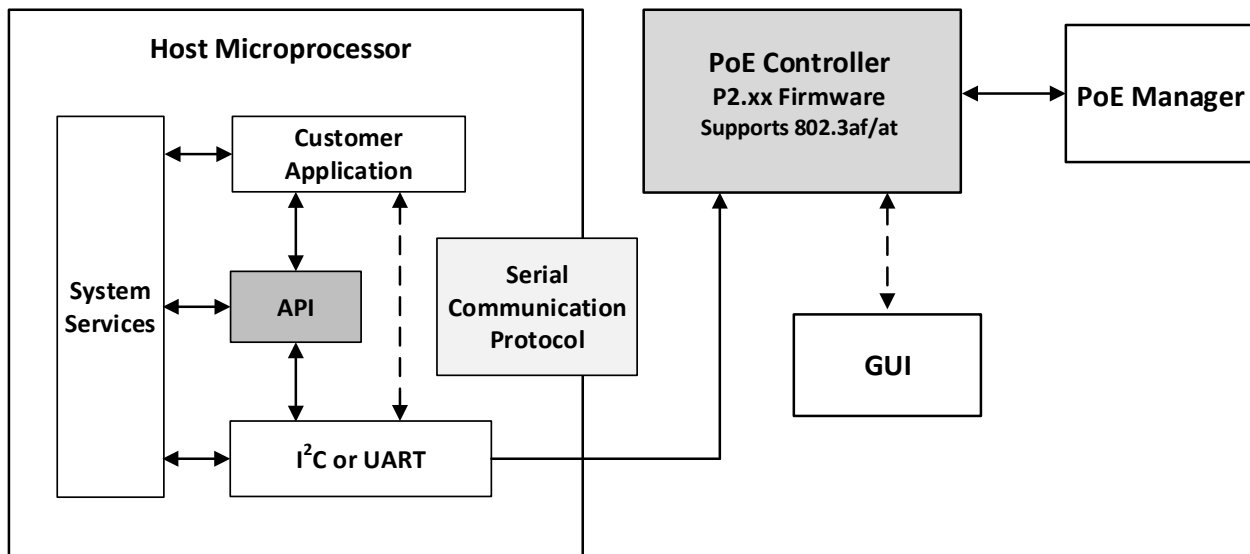

Figure 1-2. Simplified Firmware Architecture



- Dark grey boxes indicate Microchip-supplied firmware.
- Light grey boxes indicate Microchip-provided documentation.
- White boxes are user-supplied.

1.1 Firmware

- Firmware is pre-programmed in PD39210. Firmware version is identifiable via the IC Ordering Part Number.
- Firmware is vendor-agnostic with regards to choice of the host controller.
- May be operated standalone or with I²C or UART communication to host.
- Default profiles are coded into the firmware. Microchip offers a Configuration Tool for profile modification.
- Firmware is field upgradeable via the I²C or UART link.

1.2 Communication

Communication between the host application and the controller's firmware may be done via a 15-byte protocol. Customers may use a Microchip-provided API. Microchip provides a Serial Communication Protocol Guide.

1.3 GUI

This is a diagnostic tool for control of the Microchip PSE emulating or bypassing the host processor.

1.4 Software Library

Firmware (without the boot section), GUI, and API are available on [Microchip's Software Library](#).

1.5 SPI Communication

The PD39208 manager uses SPI communication in SPI client mode to communicate with the various controllers. Each manager has an address determined by ADDR0–ADDR3 pins. Each controller can support up to 12 ICs at addresses 0–11. The actual frequency between PD39210 and PD39208 ICs is 1 MHz.

The following table lists the SPI communication packet structure.

Table 1-1. SPI Communication—Packet Structure

Control Byte Selects PD39208 According to Address	R/W Bit	Internal Register Address	Number of Words (Read Access Only)	Data Written to IC (Write Access Only) Read from IC (Read Access Only)
8 bits	R(0)/W(1)	8 bits	8 bits	16 bits

For more information about the SPI interface, see the PD39208 Manager Datasheet.

1.6 UART

A pull-up resistor is required on the UART communication line. For more information, see *Designing an IEEE802.3af/at PoE System Based on PD39210/PD39208*.

UART communications configuration:

- Bits per second: 19,200 bps
- Data bits: 8
- Parity: None Stop bits: 1
- Flow control: None

1.7 I²C

The PD39210 requires the host to support I²C clock stretch.

I²C communication configuration:

- Address: 7 bits
- Clock stretch: Host should support
- Transaction: 15 bytes or 1 byte

1.8 UART or I²C Address Selection

The choice of UART or I²C interface between the host CPU is made by applying a specific voltage level to pin #13 (I2C_ADDR_MEAS) on the PD39210. Additionally, the specific I²C address is also set by this voltage level. In all cases, the voltage is set via an external resistor divider as shown in the following figure.

Figure 1-3. I²C Address Selection

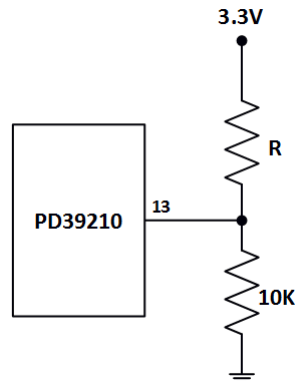

The specific Value of R to choose UART or I²C and to set the address is given in the following table.

Table 1-2. I²C Address Selection

I2C Address (Hexadecimal)	R1- KΩ (1%)
UART	N.C.
0x4	147
0x8	86.6
0xC	57.6
0x10	43.2
0x14	34
0x18	26.7
0x1C	22.1
0x20	18.2
0x24	15.4
0x28	13
0x2C	11
0x30	9.31
0x34	7.87
0x38	6.49
0x3C	5.49

2. Electrical Specifications

The following sections describe the electrical specifications for the PD39210 device.

2.1 Electrical Characteristics

For a complete list of electrical characteristics, see Microchip D21 Datasheet.

Table 2-1. General Operating Conditions

Symbol	Parameter	Conditions	Min	Typ	Max	Units
V _{DD}	Power supply voltage		3.0	3.3	3.63	V
V _{DDA}	Power supply voltage		3.0	3.3	3.63	V
T _A	Temperature range		-40	25	85	°C
T _J	Junction temperature				100	°C

2.2 Immunity

Table 2-2. Immunity

Symbol	Parameter	Conditions	Min	Max	Units
ESD	ESD rating	HBM ¹	-2000	+2000	V
		CDM ²	-500	+500	V

1. ESD HBM complies with JESD22 Class 2 standard.
2. ESD CDM complies with JESD22 Class 1 standard.

2.3 Absolute Maximum Ratings

Stresses beyond those listed in this section may cause permanent damage to the device. This is a stress rating only and functional operation of the device at these or other conditions beyond those indicated in the operational sections of this specification is not implied. Exposure to absolute maximum rating conditions for extended periods may affect device reliability.

Table 2-3. Absolute Maximum Ratings

Symbol	Parameter	Min	Max	Units
V _{DD}	Power supply voltage	0	3.8	V
V _{PIN}	Pin voltage with respect to GND and VDD	GND - 0.6 V	VDD + 0.6 V	V
	Lead soldering temperature (40 s, reflow)		260	°C
	Storage temperature	-60	150	°C

3. Pins

The PD39210 controller has 32 pins, which are described in this section.

3.1 Pin Diagrams

The following figures represent the top view of PD39210 device.

Figure 3-1. PD39210 Pin Diagram

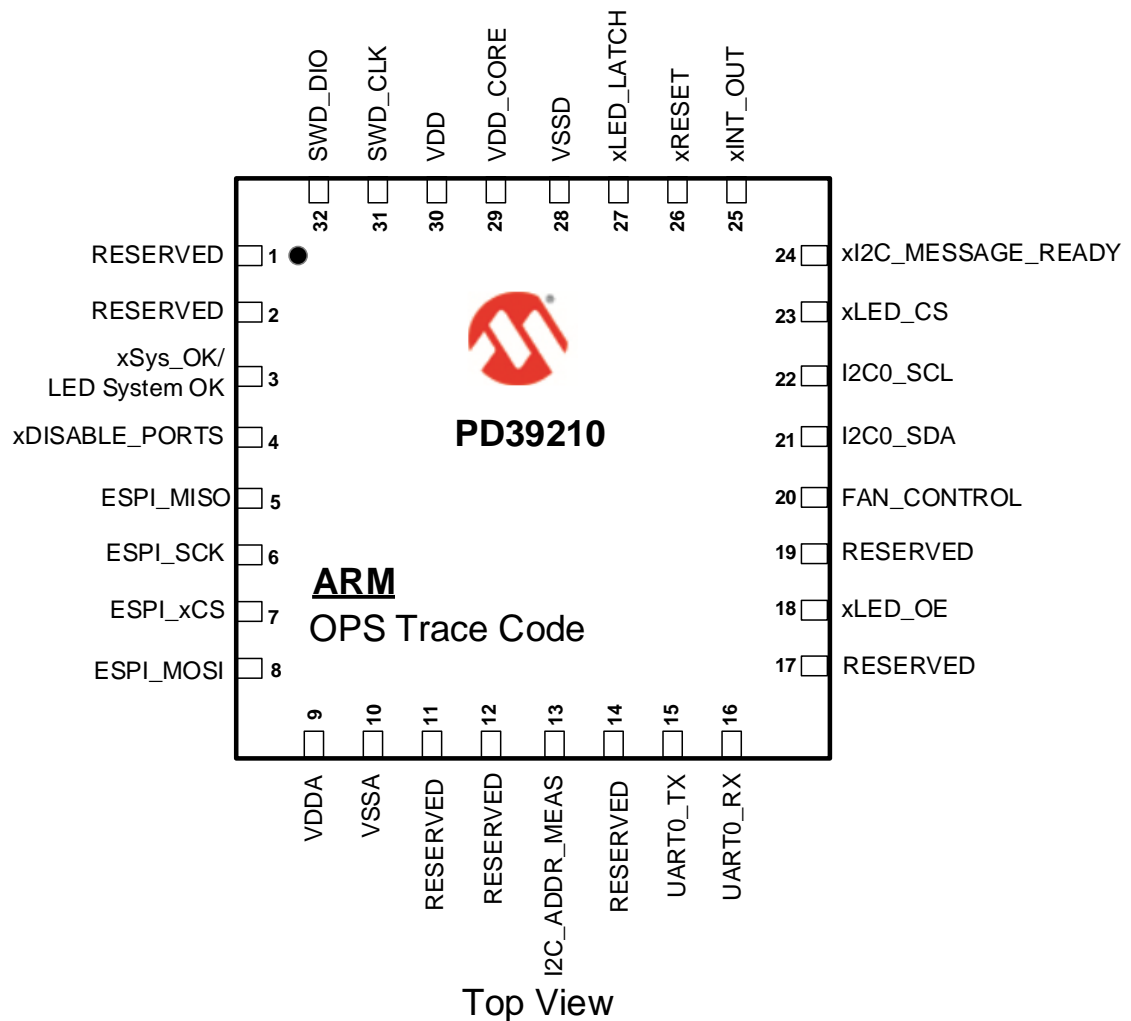

Note: For definitions about markings in the pinout diagram, see [Ordering Information](#).

3.2 Pin Descriptions

The following tables describe the functional pin descriptions of the PD39210 device.

Table 3-1. Pin Descriptions

PD39210 Pin	Designation	Type	Description
1	Reserved	OUT	Reserved UART. Leave open.
2	Reserved	IN	Reserved UART. Pull up to 3.3 V via 10 k Ω .
3	xSys_OK/LED System OK	OUT	System validity indication. The behavior of this output is controlled by individual software mask. (Active Low)
4	xDISABLE_PORTS	IN	Disable all PoE ports. When this input is asserted low, the controller shuts down all PoE ports in the system. See AN3361 for pin connection requirements. (Active Low)
5	ESPI_MISO	IN	ESPI bus to PoE manager. SPI host in, client out. SPI packets are received on this line.
6	ESPI_SCK	OUT	ESPI bus to PoE manager. SPI clock output to PD39208, and LED stream clock output, set to 1 MHz.
7	ESPI_xCS	OUT	ESPI bus to PoE manager. SPI chip select. Pull-up required. See AN3361 for pin connection requirements. (Active Low)
8	ESPI_MOSI	OUT	ESPI bus from PoE manager. SPI host out, client in. SPI packets are received on this line.
9	VDDA	Supply	Main Supply 3.3 V.
10	VSSA	GND	Ground.
11	Reserved	Analog_IN	Reserved Analog_IN. Connect to 3.3 V through 10 k Ω or GND through 10 k Ω .
12, 19	Reserved		Reserved. Leave open.
13	I2C_ADDR_MEAS	Analog_IN	Analog input to determine I ² C address or UART operation.
14	Reserved		Connect to GND.
15	UART0_TX	OUT	UART transmit to host. 15-byte protocol reply/telemetry is transmitted on this line. The baud rate is set to 19,200 bps.
16	UART0_RX	IN	UART receive from a host. 15-byte protocol commands are received on this line. The baud rate is set to 19,200 bps. Pull-up is required. See AN3361 for details.
17	Reserved	Oscillator	Reserved. Oscillator output. Leave open.
18	xLED_OE	OUT	Output enable signal for the LED stream. (Active Low)

.....continued

PD39210 Pin	Designation	Type	Description
20	FAN_CONTROL	OUT	Logic out that may be used to control a fan driver. (Active High)
21	I2C0_SDA	IN/OUT	I ² C bidirectional data. 15-byte protocol messages are transmitted on this line.
22	I2C0_SCL	IN/OUT	I ² C clock from the host. Speed is limited to 400 KHz. Clock stretch required. Pull up required, see AN3361 for details.
23	xLED_CS	OUT	Chip select signal for LED stream. (Active Low)
24	xI2C_MESSAGE_READY	OUT	I ² C message ready for reading by the host. Controller asserts this line low when it has an answer to the host. Therefore, the host can poll this line and initiate I ² C read cycle only when the message is ready. After the host reads the data from the controller, this pin is asserted to high. (Active Low)
25	xINT_OUT	OUT	Interrupt output indication. This line is asserted low when a pre-configured event is in progress. (Active Low)
26	xRESET	IN/OUT	Host Reset input (Active Low). Controller can generate self-reset. In this case, the xRESET pin is driven low by the controller for 100 μ s. See AN3361 for pin connection requirements.
27	xLED_LATCH	OUT	Latch signal for LED stream. (Active Low)
28	VSSD	GND	Ground.
29	VDD_CORE	Power	1.2 V core voltage connect 1 μ F capacitor to VSSD.
30	VDD	Supply	Main 3.3 V supply.
31	SWD_CLK		PD69210 and PD39210 use a 1 k Ω pull-up to 3.3 V. PD69220 leave open or use 1k pull-up.
32	SWD_DIO		Leave open.
ePAD	ePAD		Connect to VSSA. Must have sufficient copper mass to ensure adequate thermal performance.

4. Package Information

This section provides the package information for the PD39210 device.

4.1 PD39210 Package Outline Drawing

The following figure shows the package drawing of PD39210 devices.

Figure 4-1. PD39210 Package Outline Drawing (32-Pin QFN 5 mm × 5 mm)

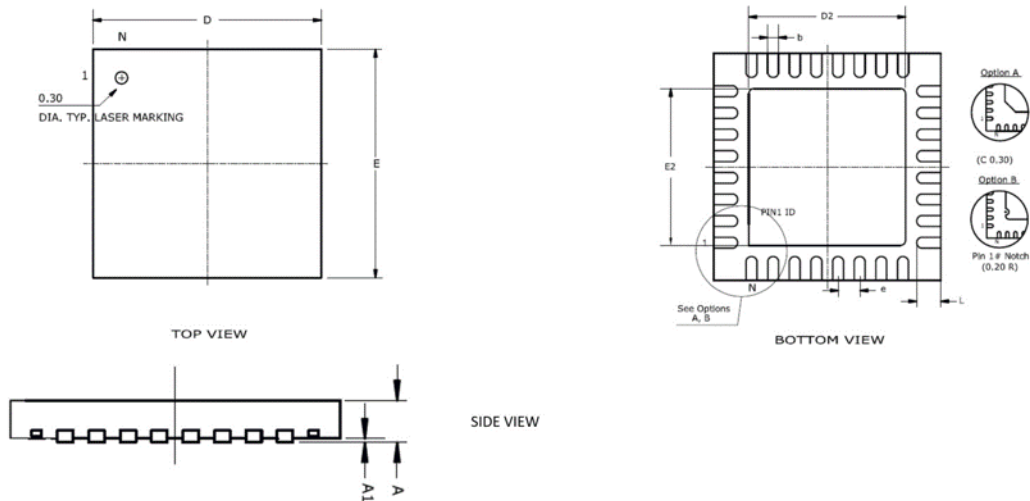

The following table lists the dimensions and measurements of the PD39210 package.

Table 4-1. PD39210 Package Outline Dimensions and Measurements

Dimension	Millimeters		Inches	
	Min	Max	Min	Max
A	0.80	1.00	0.031	0.039
A1	0.00	0.05	0	0.002
e	0.50 BSC		0.02 BSC	
L	0.30	0.50	0.012	0.02
b	0.18	0.30	0.007	0.012
D2	3.50	3.70	0.138	0.147
E2	3.50	3.70	0.138	0.147
D	5.00 BSC		0.197 BSC	
E	5.00 BSC		0.197 BSC	

Note: Dimensions do not include protrusions; they should not exceed 0.155 mm (0.006 in.) on any side. Lead dimension should not include solder coverage. Dimensions are in millimeters and inches for reference.

4.2 Thermal Specifications

The following table lists the thermal specifications of the PD39210.

Table 4-2. Thermal Specifications

Thermal Resistance	Typ	Units	Description
θ_{JA}	40.9	°C/W	Junction-to-ambient thermal resistance.
θ_{JC}	15.2	°C/W	Junction-to-case thermal resistance.

Figure 4-3. Top-Layer Copper PCB Layout

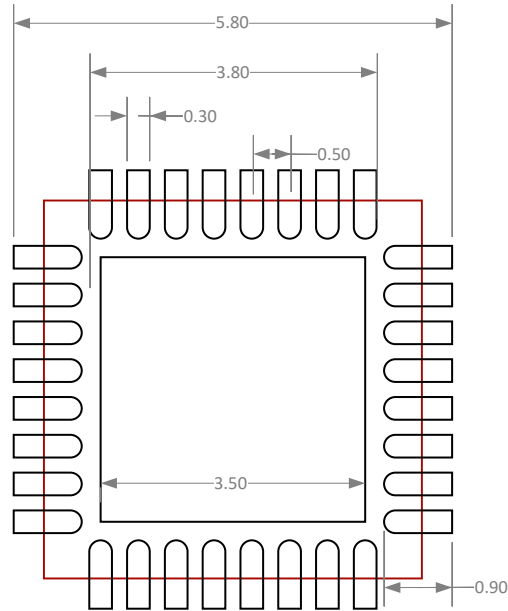
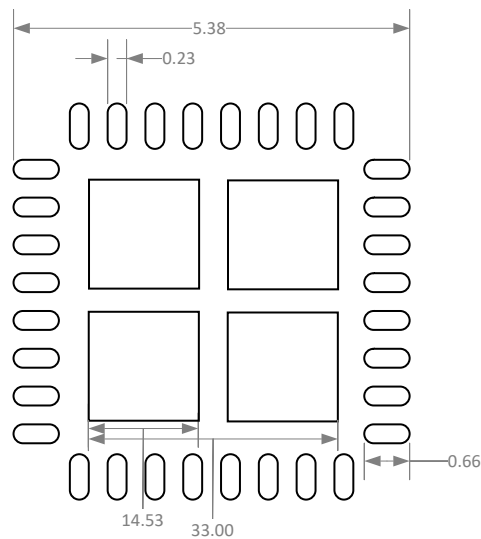

Figure 4-4. Paste Mask



All dimensions in mm

Note: The contract manufacturer has latitude to modify the solder paste stencil for manufacturability reasons. The solder paste stencil covers 65% to 80% of the thermal pad and must not allow solder to be applied to the thermal vias

under the QFN package using any method they deem appropriate. Any design should be subject to system validation and qualification prior to commitment to mass production of field deployment. Use a 5 mil stencil.

4.4 Recommended Solder Reflow Information

RoHS 6/6

Pb-free 100% Matte Tin Finish

Package Peak Temperature for Solder Reflow (40 s maximum exposure)—260 °C (0 °C, -5 °C)

Table 4-3. Classification Reflow Profiles

Profile Feature	Sn-Pb Eutectic Assembly	Pb-Free Assembly
Average ramp-up rate (TS _{max} to Tp)	3 °C/second max	3 °C/second max
Preheat		
Temperature min (TS _{min})	100 °C	150 °C
Temperature max (TS _{max})	150 °C	200 °C
Time (ts _{min} to ts _{max})	60 s to 120 s	60 s to 180 s
Time Maintained		
Temperature (T _L)	183 °C	217 °C
Time (t _L)	60 s to 150 s	60 s to 150 s
Peak classification temperature (TP)	210 °C to 235 °C	240 °C to 255 °C
Time within 5 °C of actual peak temperature (tp)	10 s to 30 s	20 s to 40 s
Ramp-down rate	6 °C/second max	6 °C/second max
Time 25 °C to peak temperature	6 minutes max	8 minutes max

Figure 4-5. Classification Reflow Profiles

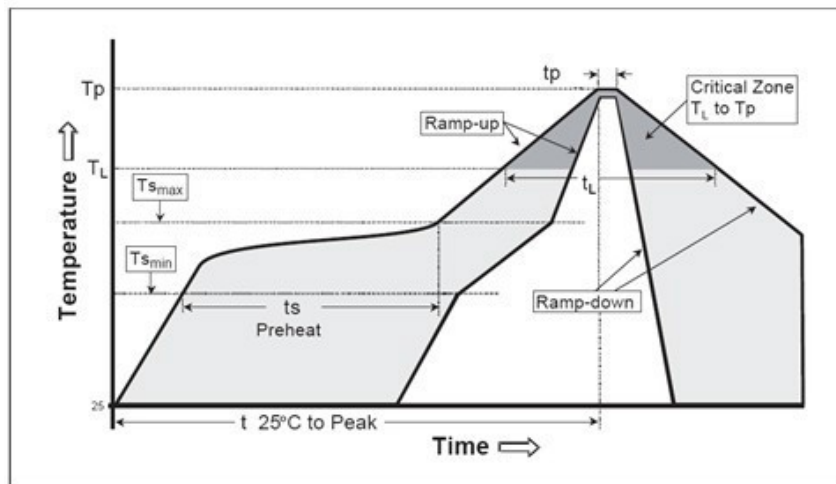

Table 4-4. Pb-Free Process—Package Classification Reflow Temperatures

Package Thickness	Volume <350 mm ³	Volume 350–2000 mm ³	Volume >2000 mm ³
Less than 1.6 mm ¹	260 + 0 °C	260 + 0 °C	260 + 0 °C

.....continued			
Package Thickness	Volume <350 mm ³	Volume 350–2000 mm ³	Volume >2000 mm ³
1.6 mm to 2.5 mm ¹	260 + 0 °C	250 + 0 °C	245 + 0 °C
Greater than or equal to 2.5 mm ¹	250 + 0 °C	245 + 0 °C	245 + 0 °C

1. Tolerance: The device manufacturer or supplier should assure process compatibility up to and including the stated classification temperature, meaning that the peak reflow temperature is +0 °C. For example, 260 °C to 0 °C, at the rated MSL value.

Note: Exceeding the ratings that are mentioned in the preceding table might cause damage to the device.

4.5 Reference Documents

- PD39210 Serial Communication Protocol User Guide
- Microchip AN3361 Designing an IEEE 802.3af/802.3at/802.3bt-Compliant PD69208 48-Port PoE System
- Microchip Designing an IEEE 802.3af/802.3at-Compliant PD39208 48-Port PoE System
- AN3378 Surge Protection Application Note 8-Port PSE PoE Manager PD69208T4/M/4T4
- PD692x0+PD69208M/208T4/204T4 Implementing Perpetual PoE (PPoE) and Fast PoE
- PD69210, PD69220 PoE PSE Controller Datasheet
- PD69200 PoE PSE Controller Datasheet
- PD39208 PoE PSE Manager Datasheet

5. Ordering Information

The following table lists the part ordering information for the PD39210 device.

Table 5-1. Ordering Information

Part Number	Package	Packaging Type	Temperature	Part Marking	Tray Marking
PD39210D ¹ VVVV ² SS ³	Plastic QFN 5 mm × 5 mm (32 lead)	Tray	–40 °C to 85 °C	Microchip Logo PD39210 ARM Logo YY ⁴ WW ⁵ NNN ⁶	PD39210D- VVVSS PD-OOOOGabb ⁷ YYWW
PD39210D ¹ VVVV ² SS ³ -TR	Plastic QFN 5 mm × 5 mm (32 lead)	Tape and reel	–40 °C to 85 °C	Microchip Logo PD39210 ARM Logo YY ⁴ WW ⁵ NNN ⁶	

1. D is detection method.
 - C= IEEE 802.3 and pre-standard
 - R= IEEE 802.3
2. VVVV is firmware revision.
3. SS is firmware parameters options.
4. Year code (last two digits of calendar year).
5. Week code (week of January 1 is week 01).
6. Alphanumeric trace code.
7. Optional part number.

The firmware release note has all required information about how to specify the choice of VVVV and SS. Find the Firmware Release Notes in the [Microchip Software Libraries](#), and register to My Microchip account to access the release notes.

Note: The package meets RoHS, Pb-free of the European Council to minimize the environmental impact of electrical equipment.

Note: Initial burning of controller's firmware is performed in the factory. Firmware upgrades can be performed by users using the communication interface. For more information, see TN-140 (Catalog Number: 06-0024-081).

6. Revision History

Revision	Date	Description
C	12/2020	<ul style="list-style-type: none">Replaced the figures in 4.3 Recommended PCB Layout with three new images.
B	09/2020	<ul style="list-style-type: none">Added "R= IEEE 802.3" to Ordering Information.
A	07/2020	<p>This is the initial issue of this document. The PD39210 PoE PSE controller is a new product offering and has not been previously described in any other document. The PD39210 PoE PSE controller was previously described in the following documents:</p> <ul style="list-style-type: none">PD69208T4 and PD69210 Datasheet (Revision 3 September 2019 Document Number PD-000357193)PD69204T4 and PD69210 Datasheet (Revision 3 September 2019 Document Number PD-000359832)PD69208M and PD69210 Datasheet (Revision 3 September 2019 Document Number PD-000359833)

The Microchip Website

Microchip provides online support via our website at www.microchip.com/. This website is used to make files and information easily available to customers. Some of the content available includes:

- **Product Support** – Data sheets and errata, application notes and sample programs, design resources, user's guides and hardware support documents, latest software releases and archived software
- **General Technical Support** – Frequently Asked Questions (FAQs), technical support requests, online discussion groups, Microchip design partner program member listing
- **Business of Microchip** – Product selector and ordering guides, latest Microchip press releases, listing of seminars and events, listings of Microchip sales offices, distributors and factory representatives

Product Change Notification Service

Microchip's product change notification service helps keep customers current on Microchip products. Subscribers will receive email notification whenever there are changes, updates, revisions or errata related to a specified product family or development tool of interest.

To register, go to www.microchip.com/pcn and follow the registration instructions.

Customer Support

Users of Microchip products can receive assistance through several channels:

- Distributor or Representative
- Local Sales Office
- Embedded Solutions Engineer (ESE)
- Technical Support

Customers should contact their distributor, representative or ESE for support. Local sales offices are also available to help customers. A listing of sales offices and locations is included in this document.

Technical support is available through the website at: www.microchip.com/support

Microchip Devices Code Protection Feature

Note the following details of the code protection feature on Microchip devices:

- Microchip products meet the specifications contained in their particular Microchip Data Sheet.
- Microchip believes that its family of products is secure when used in the intended manner and under normal conditions.
- There are dishonest and possibly illegal methods being used in attempts to breach the code protection features of the Microchip devices. We believe that these methods require using the Microchip products in a manner outside the operating specifications contained in Microchip's Data Sheets. Attempts to breach these code protection features, most likely, cannot be accomplished without violating Microchip's intellectual property rights.
- Microchip is willing to work with any customer who is concerned about the integrity of its code.
- Neither Microchip nor any other semiconductor manufacturer can guarantee the security of its code. Code protection does not mean that we are guaranteeing the product is "unbreakable." Code protection is constantly evolving. We at Microchip are committed to continuously improving the code protection features of our products. Attempts to break Microchip's code protection feature may be a violation of the Digital Millennium Copyright Act. If such acts allow unauthorized access to your software or other copyrighted work, you may have a right to sue for relief under that Act.

Legal Notice

Information contained in this publication is provided for the sole purpose of designing with and using Microchip products. Information regarding device applications and the like is provided only for your convenience and may be superseded by updates. It is your responsibility to ensure that your application meets with your specifications.

THIS INFORMATION IS PROVIDED BY MICROCHIP "AS IS". MICROCHIP MAKES NO REPRESENTATIONS OR WARRANTIES OF ANY KIND WHETHER EXPRESS OR IMPLIED, WRITTEN OR ORAL, STATUTORY OR OTHERWISE, RELATED TO THE INFORMATION INCLUDING BUT NOT LIMITED TO ANY IMPLIED WARRANTIES OF NON-INFRINGEMENT, MERCHANTABILITY, AND FITNESS FOR A PARTICULAR PURPOSE OR WARRANTIES RELATED TO ITS CONDITION, QUALITY, OR PERFORMANCE.

IN NO EVENT WILL MICROCHIP BE LIABLE FOR ANY INDIRECT, SPECIAL, PUNITIVE, INCIDENTAL OR CONSEQUENTIAL LOSS, DAMAGE, COST OR EXPENSE OF ANY KIND WHATSOEVER RELATED TO THE INFORMATION OR ITS USE, HOWEVER CAUSED, EVEN IF MICROCHIP HAS BEEN ADVISED OF THE POSSIBILITY OR THE DAMAGES ARE FORESEEABLE. TO THE FULLEST EXTENT ALLOWED BY LAW, MICROCHIP'S TOTAL LIABILITY ON ALL CLAIMS IN ANY WAY RELATED TO THE INFORMATION OR ITS USE WILL NOT EXCEED THE AMOUNT OF FEES, IF ANY, THAT YOU HAVE PAID DIRECTLY TO MICROCHIP FOR THE INFORMATION. Use of Microchip devices in life support and/or safety applications is entirely at the buyer's risk, and the buyer agrees to defend, indemnify and hold harmless Microchip from any and all damages, claims, suits, or expenses resulting from such use. No licenses are conveyed, implicitly or otherwise, under any Microchip intellectual property rights unless otherwise stated.

Trademarks

The Microchip name and logo, the Microchip logo, Adaptec, AnyRate, AVR, AVR logo, AVR Freaks, BesTime, BitCloud, chipKIT, chipKIT logo, CryptoMemory, CryptoRF, dsPIC, FlashFlex, flexPWR, HELDO, IGLOO, JukeBlox, KeeLoq, Klear, LANCheck, LinkMD, maXStylus, maXTouch, MediaLB, megaAVR, Microsemi, Microsemi logo, MOST, MOST logo, MPLAB, OptoLyzer, PackeTime, PIC, picoPower, PICSTART, PIC32 logo, PolarFire, Prochip Designer, QTouch, SAM-BA, SenGenuity, SpyNIC, SST, SST Logo, SuperFlash, Symmetricom, SyncServer, Tachyon, TempTrackr, TimeSource, tinyAVR, UNI/O, Vectron, and XMEGA are registered trademarks of Microchip Technology Incorporated in the U.S.A. and other countries.

APT, ClockWorks, The Embedded Control Solutions Company, EtherSynch, FlashTec, Hyper Speed Control, HyperLight Load, IntelliMOS, Libero, motorBench, mTouch, Powermite 3, Precision Edge, ProASIC, ProASIC Plus, ProASIC Plus logo, Quiet-Wire, SmartFusion, SyncWorld, Temux, TimeCesium, TimeHub, TimePictra, TimeProvider, Vite, WinPath, and ZL are registered trademarks of Microchip Technology Incorporated in the U.S.A.

Adjacent Key Suppression, AKS, Analog-for-the-Digital Age, Any Capacitor, AnyIn, AnyOut, BlueSky, BodyCom, CodeGuard, CryptoAuthentication, CryptoAutomotive, CryptoCompanion, CryptoController, dsPICDEM, dsPICDEM.net, Dynamic Average Matching, DAM, ECAN, EtherGREEN, In-Circuit Serial Programming, ICSP, INICnet, Inter-Chip Connectivity, JitterBlocker, KlearNet, KlearNet logo, memBrain, Mindi, MiWi, MPASM, MPF, MPLAB Certified logo, MPLIB, MPLINK, MultiTRAK, NetDetach, Omniscient Code Generation, PICDEM, PICDEM.net, PICkit, PICtail, PowerSmart, PureSilicon, QMatrix, REAL ICE, Ripple Blocker, SAM-ICE, Serial Quad I/O, SMART-I.S., SQI, SuperSwitcher, SuperSwitcher II, Total Endurance, TSHARC, USBCheck, VariSense, ViewSpan, WiperLock, Wireless DNA, and ZENA are trademarks of Microchip Technology Incorporated in the U.S.A. and other countries.

SQTP is a service mark of Microchip Technology Incorporated in the U.S.A.

The Adaptec logo, Frequency on Demand, Silicon Storage Technology, and Symmcom are registered trademarks of Microchip Technology Inc. in other countries.

GestIC is a registered trademark of Microchip Technology Germany II GmbH & Co. KG, a subsidiary of Microchip Technology Inc., in other countries.

All other trademarks mentioned herein are property of their respective companies.

© 2020, Microchip Technology Incorporated, Printed in the U.S.A., All Rights Reserved.

ISBN: 978-1-5224-7338-1

Quality Management System

For information regarding Microchip's Quality Management Systems, please visit www.microchip.com/quality.