



PD55003-E

RF power transistor from the LdmoST plastic family
of N-channel enhancement-mode lateral MOSFETs

Features

- Excellent thermal stability
- Common source configuration
- $P_{OUT} = 3\text{ W}$ with 17dB gain @ 500 MHz / 12.5 V

Description

The PD55003-E is a common source N-channel, enhancement-mode lateral field-effect RF power transistor. It is designed for high gain, broad band commercial and industrial applications. It operates at 12 V in common source mode at frequencies of up to 1 GHz. The PD55003 boasts excellent gain, linearity and reliability thanks to ST's latest LDMOS technology mounted in the first true SMD plastic RF power package, the PowerSO-10RF.

The PD55003's superior linearity performance makes it an ideal solution for car mobile radios.

The PowerSO-10RF plastic package is designed for high reliability, and is the first JEDEC-approved, high power SMD package from ST. It has been optimized for RF requirements and offers excellent RF performance and ease of assembly.

Mounting recommendations are provided in application note AN1294, available on www.st.com.



Figure 1. Pin connection



Table 1. Device summary

Order code	Package	Packing
PD55003-E	PowerSO-10RF (formed lead)	Tube
PD55003S-E	PowerSO-10RF (straight lead)	Tube
PD55003TR-E	PowerSO-10RF (formed lead)	Tape and reel
PD55003STR-E	PowerSO-10RF (straight lead)	Tape and reel

Contents

- 1 Electrical data 3**
 - 1.1 Maximum ratings 3
 - 1.2 Thermal data 3

- 2 Electrical characteristics 4**
 - 2.1 Static 4
 - 2.2 Dynamic 4
 - 2.3 Moisture sensitivity level 4

- 3 Impedance 5**

- 4 Typical performance 6**
 - 4.1 Performance for the PowerSO-10RF formed lead 7
 - 4.2 Performance for the PowerSO-10RF straight lead 10

- 5 Typical performance (860 MHz) 12**
 - 5.1 Performance for the PowerSO-10RF formed lead 12

- 6 Test circuit 13**

- 7 Circuit layout 15**

- 8 Common source s-parameter 16**

- 9 Package mechanical data 22**

- 10 Revision history 28**

1 Electrical data

1.1 Maximum ratings

Table 2. Absolute maximum ratings ($T_{CASE} = 25^{\circ}C$)

Symbol	Parameter	Value	Unit
$V_{(BR)DSS}$	Drain-source voltage	40	V
V_{GS}	Gate-source voltage	± 20	V
I_D	Drain current	2.5	A
P_{DISS}	Power dissipation (@ $T_C = 70^{\circ}C$)	31.7	W
T_J	Max. operating junction temperature	165	$^{\circ}C$
T_{STG}	Storage temperature	-65 to +150	$^{\circ}C$

1.2 Thermal data

Table 3. Thermal data

Symbol	Parameter	Value	Unit
R_{thJC}	Junction - case thermal resistance	3.0	$^{\circ}C/W$

2 Electrical characteristics

$T_{CASE} = +25\text{ }^{\circ}\text{C}$

2.1 Static

Table 4. Static

Symbol	Test conditions		Min	Typ	Max	Unit
I_{DSS}	$V_{GS} = 0$	$V_{DS} = 28\text{ V}$			1	μA
I_{GSS}	$V_{GS} = 20\text{ V}$	$V_{DS} = 0$			1	μA
$V_{GS(Q)}$	$V_{DS} = 10\text{ V}$	$I_D = 50\text{ mA}$	2.0		5.0	V
$R_{DS(ON)}$	$V_{GS} = 10\text{ V}$	$I_D = 1\text{ A}$			0.75	Ω
g_{FS}	$V_{DS} = 10\text{ V}$	$I_D = 1\text{ A}$		1.0		mho
C_{ISS}	$V_{GS} = 0$	$V_{DS} = 12.5\text{ V}$		36		pF
C_{OSS}	$V_{GS} = 0$	$V_{DS} = 12.5\text{ V}$		24		pF
C_{RSS}	$V_{GS} = 0$	$V_{DS} = 12.5\text{ V}$		2.4		pF

2.2 Dynamic

Table 5. Dynamic

Symbol	Test conditions		Min	Typ	Max	Unit
P_{1dB}	$V_{DD} = 12.5\text{ V}$, $I_{DQ} = 50\text{ mA}$	$f = 500\text{ MHz}$	3			W
G_P	$V_{DD} = 12.5\text{ V}$, $I_{DQ} = 50\text{ mA}$, $P_{OUT} = 3\text{ W}$, $f = 500\text{ MHz}$		14	17		dB
h_D	$V_{DD} = 12.5\text{ V}$, $I_{DQ} = 50\text{ mA}$, $P_{OUT} = 3\text{ W}$, $f = 500\text{ MHz}$		45	52		%
Load mismatch	$V_{DD} = 15.5\text{ V}$, $I_{DQ} = 50\text{ mA}$, $P_{OUT} = 3\text{ W}$, $f = 500\text{ MHz}$ All phase angles		20:1			VSWR

2.3 Moisture sensitivity level

Table 6. Moisture sensitivity level

Test methodology	Rating
J-STD-020B	MSL 3

3 Impedance

Figure 2. Current conventions

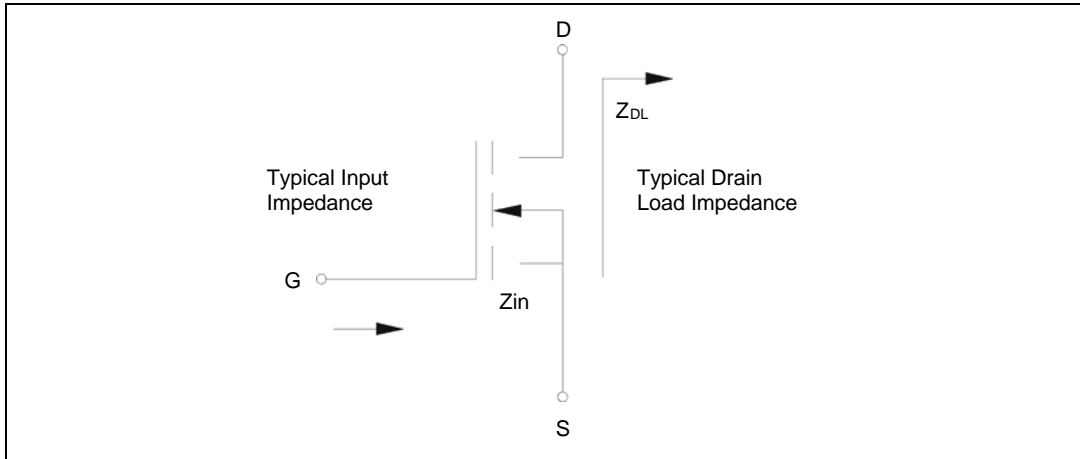

Table 7. Impedance data

PD55003-E			PD55003S-E		
Freq. (MHz)	$Z_{IN} (\Omega)$	$Z_{DL}(\Omega)$	Freq. (MHz)	$Z_{IN} (\Omega)$	$Z_{DL}(\Omega)$
520	1.871 - j 1.118	4.779 + j 4.956	520	1.407 - j 3.550	6.557 + j 7.844
500	1.542 - j 3.705	6.842 + j 6.209	500	1.306 - j 5.159	8.351 + j 9.120
480	1.109 - j 1.783	6.789 + j 4.533	480	1.302 - j 6.141	8.994 + j 8.983
860	1.33 + j 1.23	2.93 + j 0.62			

4 Typical performance

Figure 3. Capacitance vs. drain voltage



Figure 4. Drain current vs. gate-source voltage

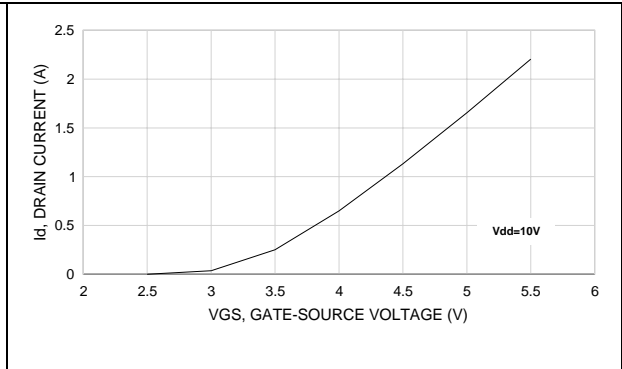

Figure 5. Gate-source voltage vs. case temperature

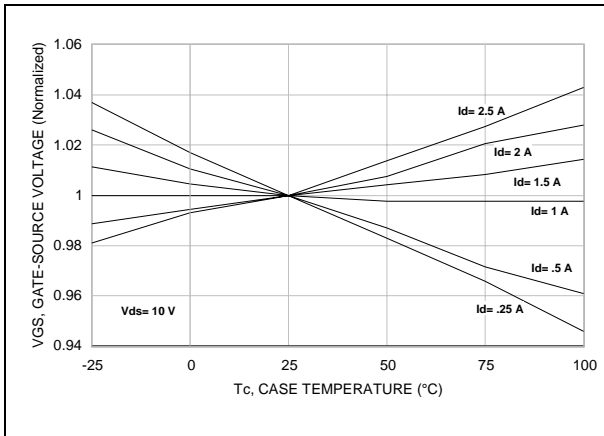
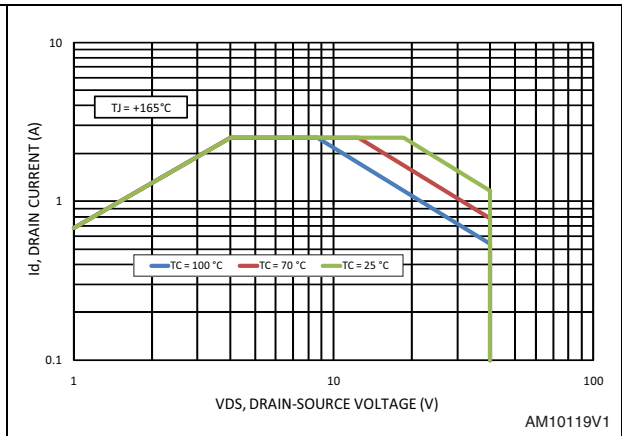

Figure 6. Maximum safe operating area



4.1 Performance for the PowerSO-10RF formed lead

Figure 7. Output power vs. input power

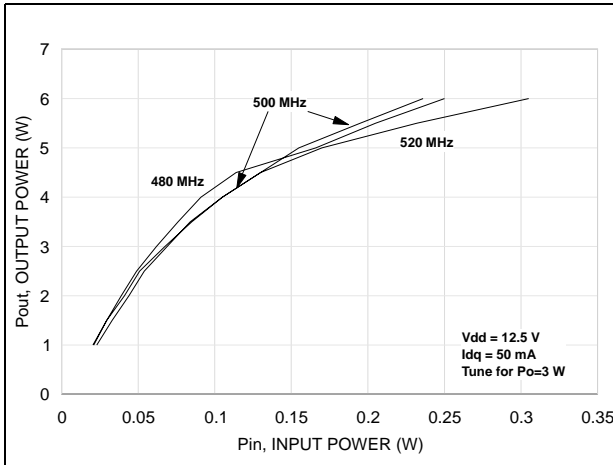

Figure 8. Output power vs. input power

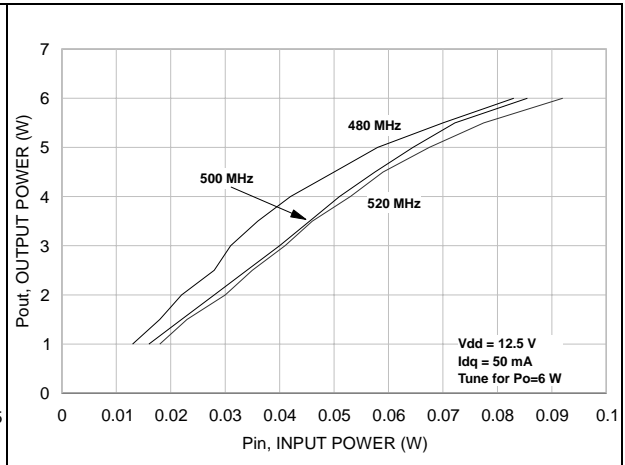

Figure 9. Drain efficiency vs. output power



Figure 10. Drain efficiency vs. output power



Figure 11. Power gain vs. output power



Figure 12. Return loss vs. output power

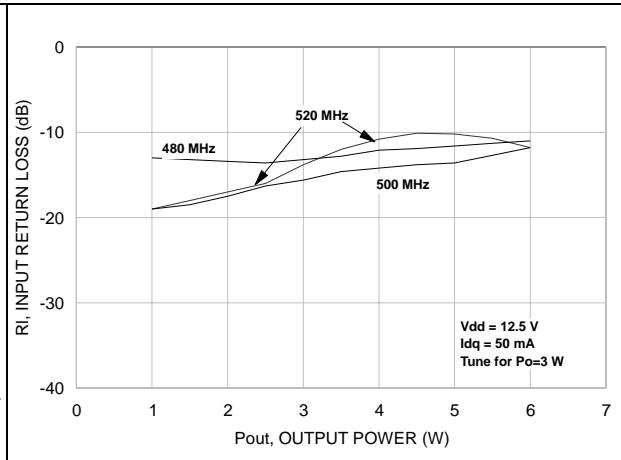

Figure 13. Output power vs. bias current

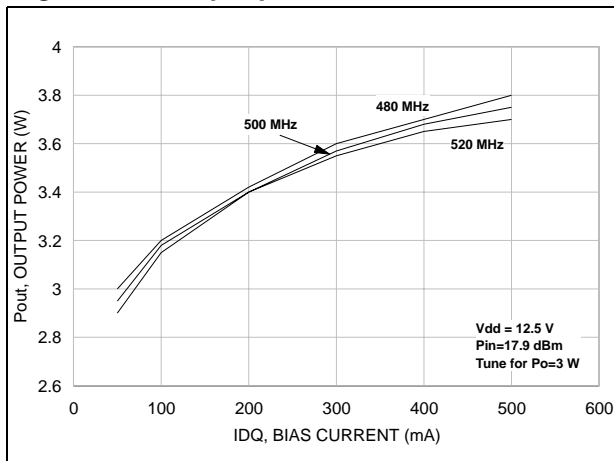

Figure 14. Drain efficiency vs. bias current

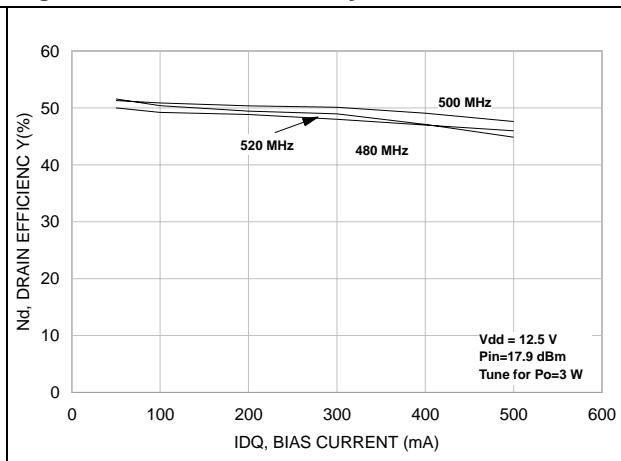

Figure 15. Output power vs. supply voltage



Table 8. Drain efficiency vs. supply voltage

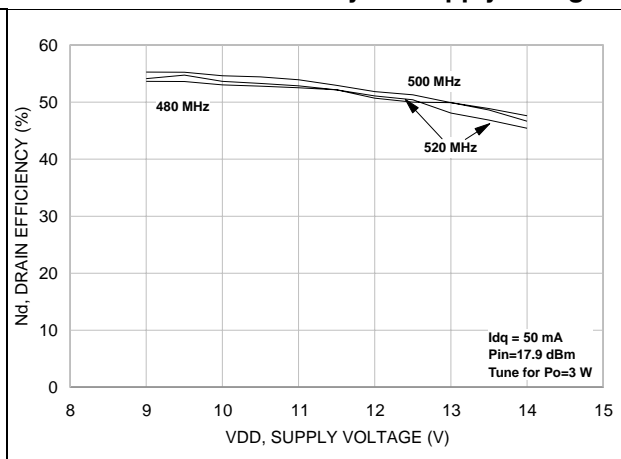

Figure 16. Output power vs. gate voltage



4.2 Performance for the PowerSO-10RF straight lead

Figure 17. Output power vs. input power

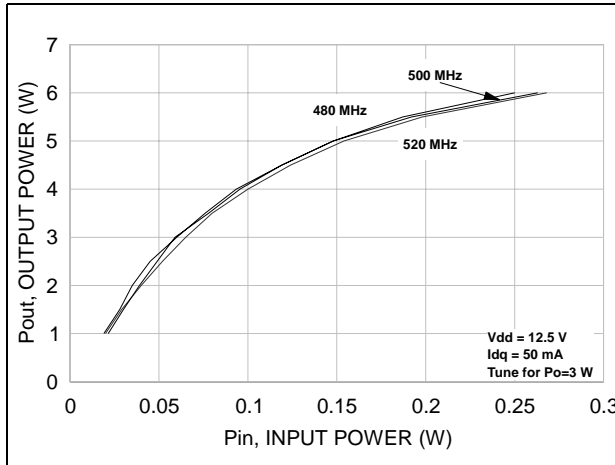

Figure 18. Output power vs. input power

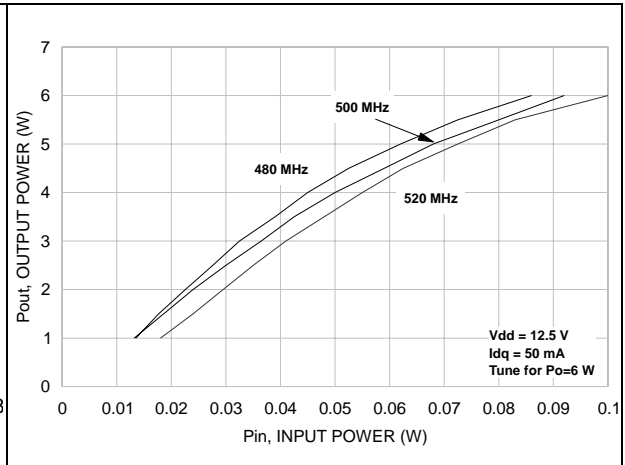

Figure 19. Drain efficiency vs. output power

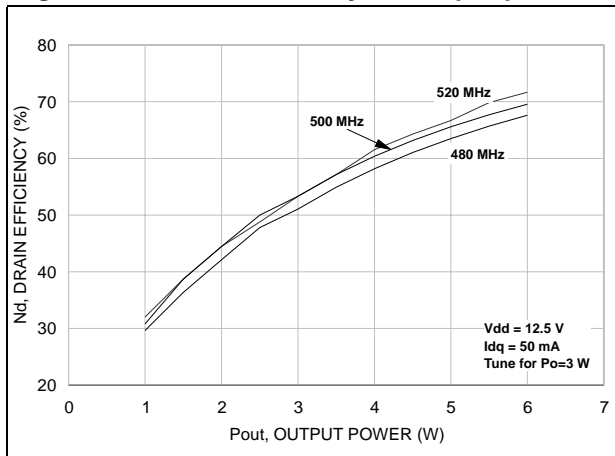

Figure 20. Drain efficiency vs. output power



Figure 21. Power gain vs. output power

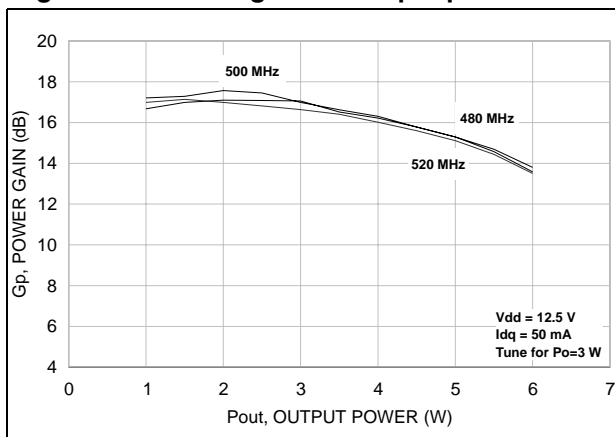

Figure 22. Return loss vs. output power

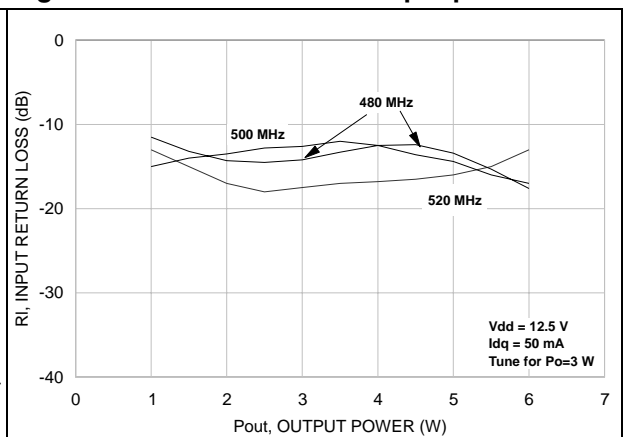

Figure 23. Output power vs. bias current



Figure 24. Drain efficiency vs. bias current

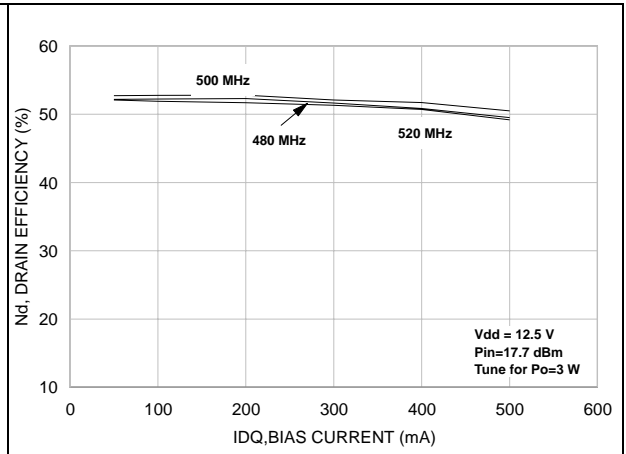

Figure 25. Output power vs. supply voltage



Figure 26. Drain efficiency vs. supply voltage

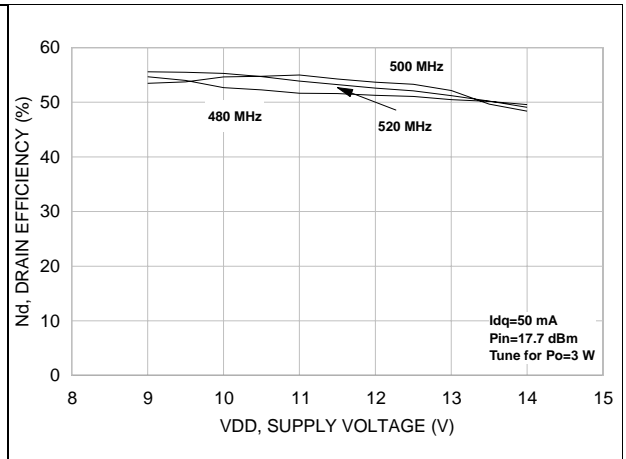
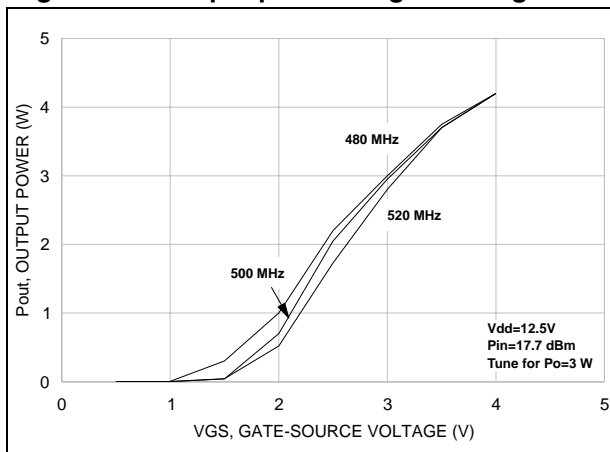

Figure 27. Output power vs. gate voltage



5 Typical performance (860 MHz)

5.1 Performance for the PowerSO-10RF formed lead

Figure 28. Output power vs. input power

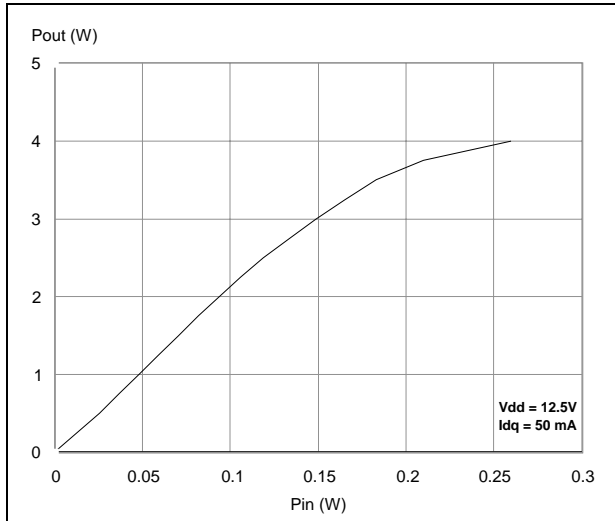

Figure 29. Drain efficiency vs. output power

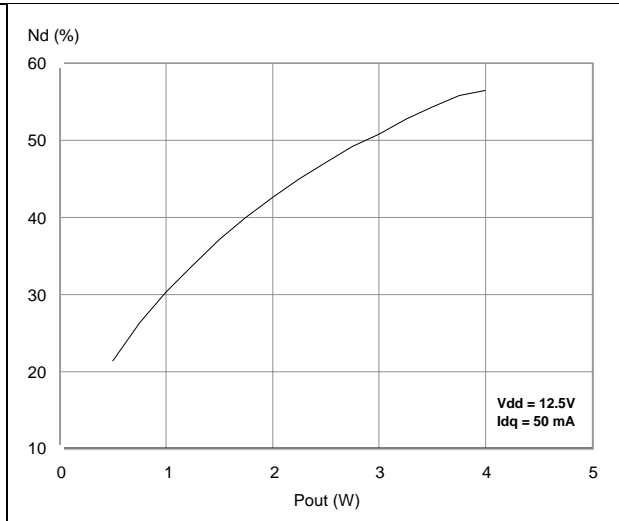
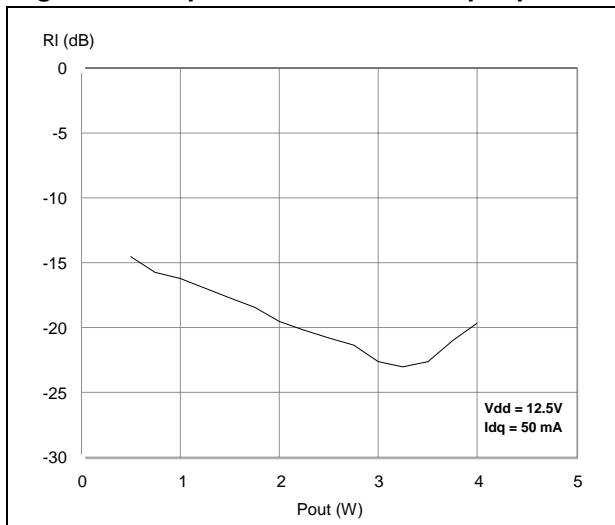

Figure 30. Input return loss vs. output power



6 Test circuit

Figure 31. Test circuit schematic

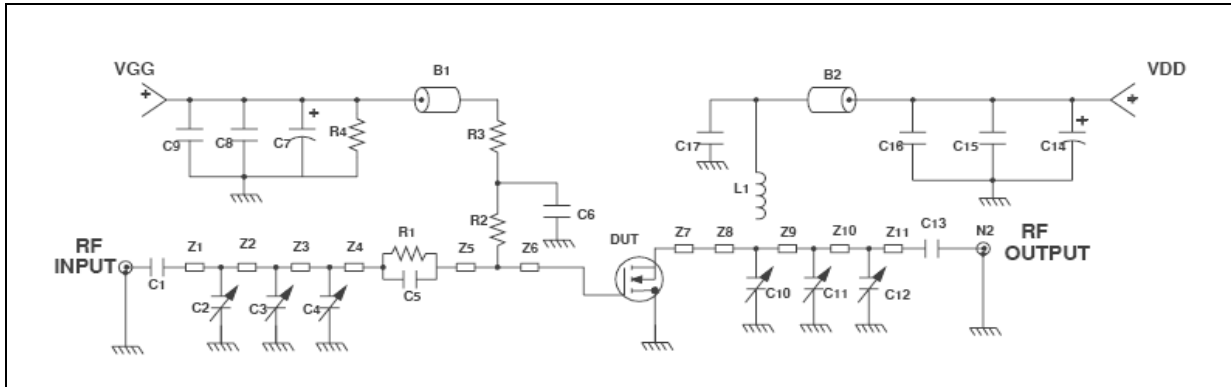

Table 9. Test circuit component list

Component	Description
B1,B2	Short ferrite bead, Fair-Rite Products Corp (2743021446)
C1,C14	240 pF, 100 mil chip capacitor
C2,C3,C4,C10,C11,C12	0 TO 20 pF trimmer capacitor
C5	130 pF, 100 mil chip cap
C6,C17	120 pF, 100 mil chip cap
C7,C14	10 μ F, 50 V electrolytic capacitor
C8,C15	1.200 pF, 100 mil chip cap
C9,C16	0.1 F, 100 mil chip cap
L1	55.5 nH, 5 turn, Coilcraft
N1,N2	Type N flange mount
R1	15 Ω , 0805 chip resistor
R2	1.0 k Ω , 1/8 W resistor
R3	15 Ω , 0805 chip resistor
R4	33 k Ω , 1/8 W resistor
Z1	0.175" X 0.080" microstrip
Z2	1.049" X 0.080" microstrip
Z3	0.289" X 0.080" microstrip
Z4	0.026" X 0.080" microstrip
Z5	0.192" X 0.223" microstrip
Z6,Z7	0.260" X 0.223" microstrip
Z8	0.064" X 0.080" microstrip
Z9	0.334" X 0.080" microstrip

Table 9. Test circuit component list (continued)

Component	Description
Z10	0.985" X 0.080" microstrip
Z11	0.472" X 0.080" microstrip
Board	Roger ultra LAM 2000 THK 0.030" $\epsilon_r = 2.55$ 2oz ED C μ both sides

7 Circuit layout

Figure 32. Test fixture component layout

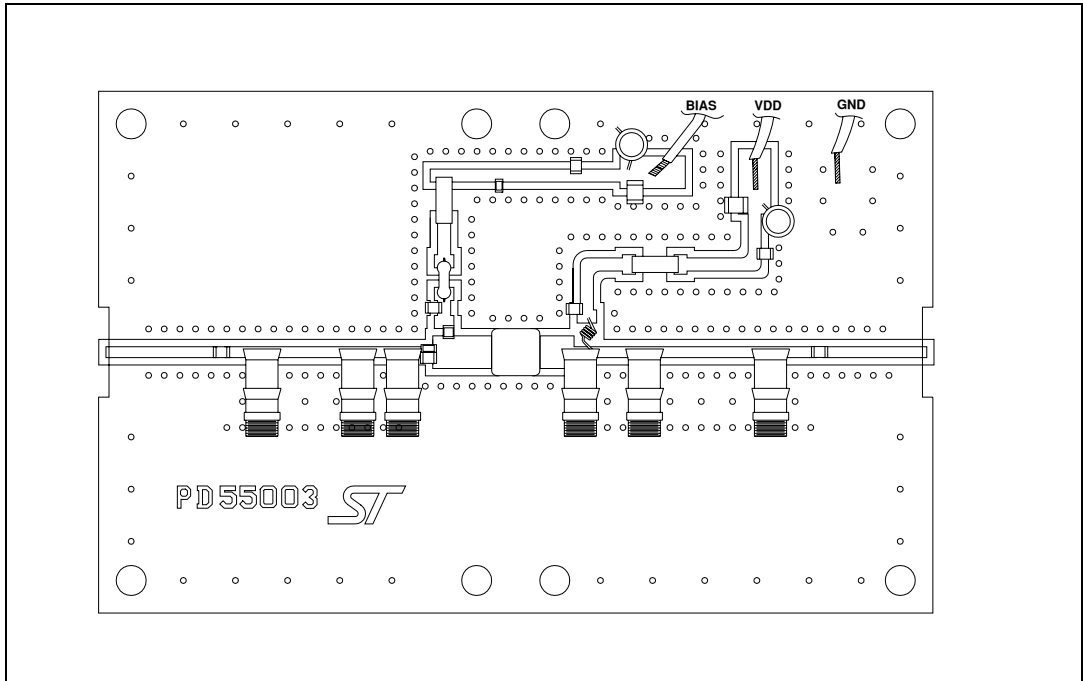
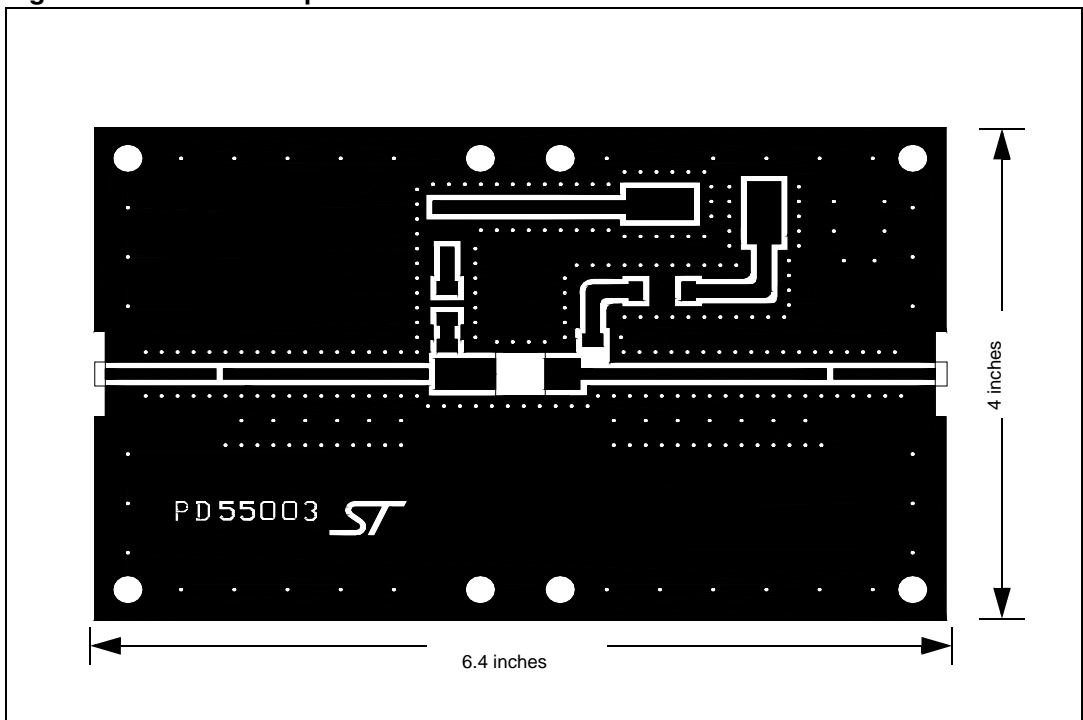

Figure 33. Test circuit photomaster



8 Common source s-parameter

Table 10. S-parameter for the PowerSO-10RF formed lead ($V_{DS} = 12.5\text{ V}$, $I_{DS} = 0.15\text{ A}$)

Freq (MHz)	$ S_{11} $	$S_{11}\angle\Phi$	$ S_{21} $	$S_{21}\angle\Phi$	$ S_{12} $	$S_{12} - \text{DF}$	$ S_{22} $	$S_{22} - \text{DF}$
50	0.780	-120	21.77	106	0.038	19	0.669	-111
100	0.764	-144	11.34	88	0.040	-1	0.643	-137
150	0.786	-154	7.47	77	0.040	-10	0.634	-145
200	0.804	-159	5.45	69	0.037	-19	0.660	-149
250	0.817	-163	4.22	61	0.036	-26	0.680	-152
300	0.835	-165	3.36	55	0.034	-31	0.720	-156
350	0.852	-167	2.75	48	0.031	-36	0.766	-158
400	0.865	-169	2.28	43	0.028	-41	0.786	-160
450	0.877	-171	1.92	38	0.027	-45	0.816	-161
500	0.889	-172	1.65	34	0.025	-49	0.827	-163
550	0.899	-174	1.42	30	0.022	-52	0.847	-165
600	0.909	-175	1.24	27	0.021	-51	0.856	-167
650	0.918	-177	1.09	23	0.018	-56	0.874	-169
700	0.924	-178	0.97	20	0.018	-54	0.881	-170
750	0.926	-179	0.87	17	0.016	-61	0.895	-172
800	0.929	180	0.78	15	0.014	-62	0.906	-173
850	0.935	179	0.71	12	0.011	-56	0.916	-174
900	0.938	178	0.65	10	0.011	-63	0.913	-175
950	0.940	177	0.59	8	0.010	-62	0.925	-177
1000	0.941	176	0.55	5	0.007	-69	0.928	-178
1050	0.944	175	0.51	3	0.007	-57	0.925	-180
1100	0.947	174	0.47	1	0.006	-56	0.929	-180
1150	0.946	173	0.44	-1	0.005	-53	0.928	179
1200	0.944	172	0.41	-3	0.004	-40	0.927	178
1250	0.949	171	0.38	-5	0.004	-54	0.928	176
1300	0.949	170	0.36	-7	0.003	-63	0.940	176
1350	0.947	169	0.34	-9	0.001	-15	0.935	175
1400	0.949	168	0.31	-10	0.001	82	0.938	175
1450	0.946	167	0.29	-12	0.002	76	0.933	174
1500	0.948	167	0.27	-12	0.002	124	0.939	173

Table 11. S-parameter for the PowerSO-10RF formed lead ($V_{DS} = 12.5\text{ V}$, $I_{DS} = 0.8\text{ A}$)

Freq (MHz)	$ S_{11} $	$S_{11}\angle\Phi$	$ S_{21} $	$S_{21}\angle\Phi$	$ S_{12} $	$S_{12} - \text{DF}$	$ S_{22} $	$S_{22} - \text{DF}$
50	0.786	-138	26.54	100	0.026	13	0.666	-137
100	0.791	-156	13.46	87	0.026	0	0.674	-155
150	0.816	-163	8.94	80	0.027	-5	0.662	-160
200	0.829	-167	6.63	73	0.026	-13	0.678	-163
250	0.835	-170	5.24	67	0.025	-16	0.677	-164
300	0.846	-171	4.26	62	0.025	-21	0.709	-167
350	0.854	-173	3.57	56	0.023	-25	0.736	-167
400	0.864	-174	3.01	51	0.021	-31	0.758	-168
450	0.872	-175	2.58	47	0.021	-31	0.783	-167
500	0.878	-176	2.24	43	0.019	-34	0.787	-168
550	0.890	-177	1.97	39	0.018	-37	0.800	-170
600	0.896	-178	1.74	36	0.017	-39	0.816	-171
650	0.902	-179	1.56	32	0.014	-44	0.827	-173
700	0.910	180	1.41	29	0.015	-38	0.845	-173
750	0.909	179	1.27	26	0.012	-46	0.854	-175
800	0.917	178	1.16	23	0.011	-41	0.865	-175
850	0.918	177	1.06	21	0.008	-37	0.879	-176
900	0.925	176	0.97	18	0.010	-43	0.877	-177
950	0.926	175	0.90	15	0.008	-47	0.887	-179
1000	0.927	174	0.83	12	0.007	-44	0.889	180
1050	0.921	173	0.77	10	0.007	-47	0.898	179
1100	0.932	172	0.72	8	0.006	-11	0.902	179
1150	0.933	172	0.67	6	0.005	-35	0.895	178
1200	0.930	171	0.63	4	0.004	-16	0.901	177
1250	0.937	170	0.59	1	0.004	-14	0.897	176
1300	0.937	169	0.55	-1	0.004	4	0.916	176
1350	0.936	168	0.52	-3	0.003	1	0.909	175
1400	0.937	168	0.49	-4	0.004	39	0.917	174
1450	0.934	167	0.45	-6	0.004	60	0.910	173
1500	0.938	166	0.43	-7	0.002	73	0.916	172

Table 12. S-parameter for the PowerSO-10RF formed lead ($V_{DS} = 12.5$ V, $I_{DS} = 1.5$ A)

Freq (MHz)	$ S_{11} $	$S_{11}\angle\Phi$	$ S_{21} $	$S_{21}\angle\Phi$	$ S_{12} $	$S_{12} - DF$	$ S_{22} $	$S_{22} - DF$
50	0.789	-140	26.35	100	0.025	15	0.666	-141
100	0.800	-157	13.35	87	0.025	-1	0.675	-157
150	0.825	-164	8.88	80	0.024	-6	0.667	-162
200	0.836	-168	6.59	74	0.023	-13	0.678	-164
250	0.842	-171	5.22	68	0.024	-16	0.678	-165
300	0.851	-172	4.26	62	0.022	-18	0.713	-168
350	0.856	-174	3.56	57	0.021	-25	0.738	-168
400	0.864	-175	3.02	52	0.021	-28	0.754	-168
450	0.874	-176	2.60	48	0.019	-32	0.770	-168
500	0.882	-177	2.25	44	0.017	-32	0.782	-169
550	0.888	-178	1.98	40	0.016	-33	0.796	-171
600	0.898	-179	1.76	36	0.016	-37	0.806	-172
650	0.901	-180	1.58	33	0.013	-34	0.825	-173
700	0.909	179	1.42	30	0.013	-42	0.843	-174
750	0.910	178	1.29	27	0.011	-36	0.852	-175
800	0.915	177	1.18	24	0.012	-36	0.861	-176
850	0.915	177	1.08	21	0.010	-26	0.863	-176
900	0.922	176	0.99	19	0.009	-28	0.873	-178
950	0.926	175	0.92	16	0.008	-39	0.880	-179
1000	0.925	174	0.85	13	0.007	-39	0.882	180
1050	0.927	173	0.79	11	0.006	-27	0.892	179
1100	0.928	172	0.74	9	0.005	-35	0.891	178
1150	0.932	171	0.68	6	0.006	-11	0.899	178
1200	0.929	170	0.64	4	0.005	-20	0.896	177
1250	0.933	170	0.60	1	0.004	8	0.889	176
1300	0.935	169	0.57	0	0.005	15	0.907	175
1350	0.933	168	0.53	-3	0.004	25	0.904	174
1400	0.936	167	0.50	-4	0.003	53	0.911	174
1450	0.934	166	0.49	-6	0.004	53	0.909	173
1500	0.936	165	0.44	-7	0.004	64	0.914	172

Table 13. S-parameter for the PowerSO-10RF straight lead ($V_{DS} = 12.5\text{ V}$, $I_{DS} = 0.15\text{ A}$)

Freq (MHz)	$ S_{11} $	$S_{11}\angle\Phi$	$ S_{21} $	$S_{21}\angle\Phi$	$ S_{12} $	$S_{12} - \text{DF}$	$ S_{22} $	$S_{22} - \text{DF}$
50	0.790	-120	22	107	0.038	17	0.682	-114
100	0.773	-145	11	89	0.039	-2	0.647	-138
150	0.791	-154	7	78	0.039	-9	0.640	-147
200	0.807	-159	5	70	0.037	-19	0.671	-151
250	0.820	-162	4	63	0.036	-23	0.691	-154
300	0.836	-164	3	56	0.033	-29	0.728	-156
350	0.850	-166	3	50	0.032	-33	0.751	-158
400	0.867	-167	2	45	0.030	-36	0.782	-160
450	0.880	-169	2	40	0.027	-43	0.808	-161
500	0.890	-170	2	36	0.024	-43	0.835	-163
550	0.902	-171	1	33	0.023	-50	0.845	-165
600	0.911	-172	1	29	0.022	-51	0.864	-166
650	0.919	-173	1	26	0.020	-55	0.872	-167
700	0.923	-174	1	23	0.018	-52	0.884	-169
750	0.924	-176	1	20	0.016	-55	0.887	-170
800	0.933	-177	1	18	0.015	-55	0.895	-172
850	0.936	-177	1	15	0.015	-56	0.912	-173
900	0.940	-178	1	13	0.012	-59	0.916	-174
950	0.943	-179	1	11	0.011	-53	0.926	-176
1000	0.944	-180	1	8	0.008	-60	0.943	-177
1050	0.949	180	1	7	0.007	-64	0.935	-177
1100	0.948	179	0	4	0.007	-44	0.944	-178
1150	0.950	178	0	3	0.006	-44	0.939	-179
1200	0.950	177	0	-1	0.005	-50	0.942	-180
1250	0.955	177	0	-2	0.004	-42	0.941	179
1300	0.951	176	0	-4	0.004	-41	0.933	178
1350	0.953	175	0	-5	0.004	-50	0.933	177
1400	0.953	175	0	-7	0.002	-41	0.947	176
1450	0.952	173	0	-9	0.002	-13	0.952	175
1500	0.949	173	0	-10	0.000	-3	0.958	174

Table 14. S-parameter for the PowerSO-10RF straight lead ($V_{DS} = 12.5\text{ V}$, $I_{DS} = 0.8\text{ A}$)

Freq (MHz)	$ S_{11} $	$S_{11}\angle\Phi$	$ S_{21} $	$S_{21}\angle\Phi$	$ S_{12} $	$S_{12} - \text{DF}$	$ S_{22} $	$S_{22} - \text{DF}$
50	0.807	-137	26.18	102	0.025	12	0.682	-140
100	0.809	-156	13.41	88	0.026	0	0.683	-157
150	0.827	-163	8.92	81	0.025	-6	0.677	-162
200	0.838	-167	6.64	75	0.024	-12	0.698	-165
250	0.842	-169	5.24	69	0.026	-13	0.704	-166
300	0.849	-171	4.28	64	0.022	-19	0.720	-167
350	0.856	-172	3.57	59	0.023	-21	0.736	-167
400	0.866	-173	3.03	54	0.021	-28	0.758	-168
450	0.873	-174	2.61	50	0.020	-30	0.773	-168
500	0.881	-174	2.26	46	0.056	-27	0.797	-169
550	0.891	-175	1.99	42	0.018	-36	0.806	-170
600	0.896	-176	1.76	39	0.017	-35	0.825	-171
650	0.902	-176	1.58	36	0.016	-38	0.831	-171
700	0.908	-177	1.42	33	0.015	-39	0.834	-172
750	0.910	-178	1.29	30	0.014	-40	0.845	-174
800	0.916	-179	1.18	27	0.012	-43	0.859	-174
850	0.922	-180	1.08	25	0.011	-40	0.864	-175
900	0.926	180	1.00	22	0.009	-44	0.878	-176
950	0.927	179	0.93	19	0.010	-43	0.892	-178
1000	0.929	178	0.85	17	0.007	-34	0.905	-178
1050	0.937	178	0.80	15	0.007	-30	0.901	-179
1100	0.934	177	0.75	12	0.006	-29	0.910	-179
1150	0.934	177	0.70	10	0.006	-29	0.914	-180
1200	0.937	176	0.65	7	0.005	-23	0.912	180
1250	0.941	175	0.62	5	0.005	-25	0.912	179
1300	0.938	175	0.57	3	0.005	-3	0.909	177
1350	0.941	174	0.54	1	0.004	3	0.906	176
1400	0.941	174	0.51	-1	0.004	18	0.918	176
1450	0.939	173	0.48	-2	0.003	21	0.925	174
1500	0.939	172	0.45	-3	0.002	42	0.931	173

Table 15. S-parameter for the PowerSO-10RF straight lead ($V_{DS} = 12.5\text{ V}$, $I_{DS} = 1.5\text{ A}$)

Freq (MHz)	$ S_{11} $	$S_{11}\angle\Phi$	$ S_{21} $	$S_{21}\angle\Phi$	$ S_{12} $	$S_{12} - \text{DF}$	$ S_{22} $	$S_{22} - \text{DF}$
50	0.816	-140	26.05	101	0.024	11	0.684	-144
100	0.817	-157	13.34	88	0.025	-2	0.690	-159
150	0.839	-164	8.89	82	0.024	-3	0.685	-164
200	0.847	-168	6.62	76	0.024	-10	0.701	-166
250	0.850	-170	5.25	70	0.023	-14	0.707	-168
300	0.655	-171	4.29	65	0.023	-17	0.726	-168
350	0.861	-173	3.59	60	0.021	-21	0.735	-169
400	0.869	-174	3.06	55	0.020	-24	0.761	-169
450	0.877	-174	2.64	51	0.019	-27	0.769	-170
500	0.884	-175	2.30	47	0.017	-31	0.795	-170
550	0.893	-176	2.02	44	0.017	-26	0.800	-171
600	0.898	-177	1.80	40	0.015	-36	0.819	-172
650	0.905	-177	1.62	38	0.015	-36	0.829	-172
700	0.908	-178	1.46	34	0.014	-34	0.831	-173
750	0.909	-179	1.33	31	0.012	-35	0.842	-174
800	0.914	-179	1.21	29	0.012	-36	0.852	-175
850	0.918	-180	1.11	26	0.011	-31	0.856	-176
900	0.923	179	1.03	23	0.009	-32	0.872	-177
950	0.927	179	0.96	21	0.009	-34	0.879	-178
1000	0.926	178	0.88	18	0.008	-21	0.894	-178
1050	0.935	178	0.83	16	0.007	-20	0.898	-179
1100	0.933	177	0.78	13	0.007	-22	0.900	-179
1150	0.933	176	0.73	10	0.006	-15	0.904	180
1200	0.934	175	0.68	8	0.005	-18	0.903	179
1250	0.940	175	0.64	6	0.004	-16	0.901	178
1300	0.935	174	0.59	4	0.004	4	0.902	177
1350	0.938	174	0.56	2	0.005	5	0.898	176
1400	0.938	173	0.53	0	0.005	25	0.915	175
1450	0.939	173	0.50	-2	0.004	14	0.925	174
1500	0.935	172	0.47	-3	0.002	48	0.928	173

9 Package mechanical data

In order to meet environmental requirements, ST offers these devices in different grades of ECOPACK[®] packages, depending on their level of environmental compliance. ECOPACK[®] specifications, grade definitions and product status are available at: www.st.com. ECOPACK[®] is an ST trademark.

Table 16. PowerSO-10RF formed lead (gull wing) mechanical data

Dim.	mm.			Inch		
	Min	Typ	Max	Min	Typ	Max
A1	0	0.05	0.1	0.	0.0019	0.0038
A2	3.4	3.5	3.6	0.134	0.137	0.142
A3	1.2	1.3	1.4	0.046	0.05	0.054
A4	0.15	0.2	0.25	0.005	0.007	0.009
a		0.2			0.007	
b	5.4	5.53	5.65	0.212	0.217	0.221
c	0.23	0.27	0.32	0.008	0.01	0.012
D	9.4	9.5	9.6	0.370	0.374	0.377
D1	7.4	7.5	7.6	0.290	0.295	0.298
E	13.85	14.1	14.35	0.544	0.555	0.565
E1	9.3	9.4	9.5	0.365	0.37	0.375
E2	7.3	7.4	7.5	0.286	0.292	0.294
E3	5.9	6.1	6.3	0.231	0.24	0.247
F		0.5			0.019	
G		1.2			0.047	
L	0.8	1	1.1	0.030	0.039	0.042
R1			0.25			0.01
R2		0.8			0.031	
T	2 deg	5 deg	8 deg	2 deg	5 deg	8 deg
T1		6 deg			6 deg	
T2		10 deg			10 deg	

Note: Resin protrusions not included (max value: 0.15 mm per side)

Figure 34. Package dimensions

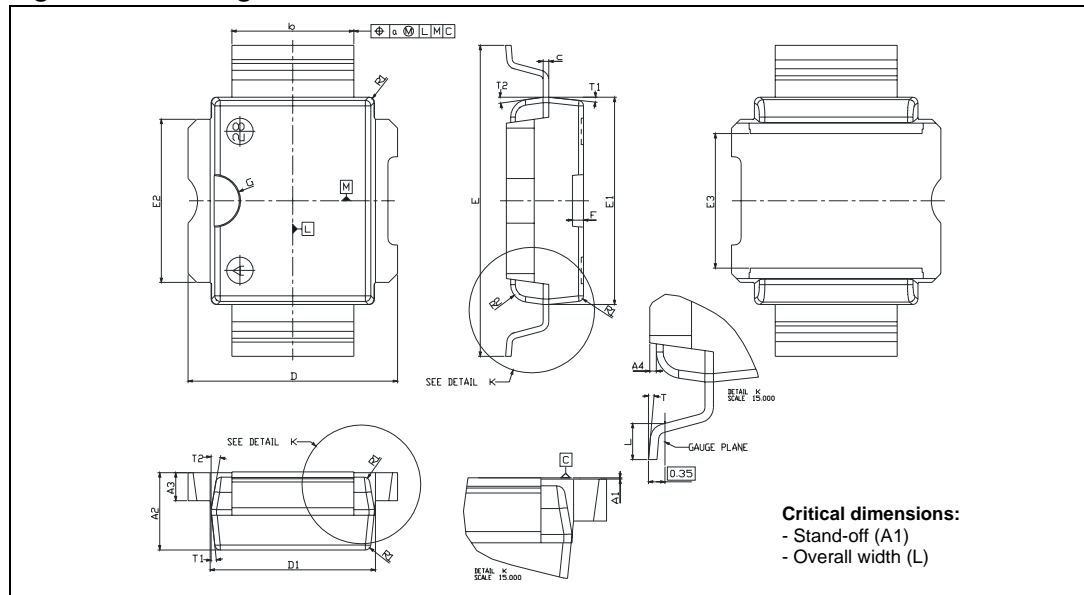

Table 17. PowerSO-10RF straight lead mechanical data

Dim.	mm.			Inch		
	Min	Typ	Max	Min	Typ	Max
A1	1.62	1.67	1.72	0.064	0.065	0.068
A2	3.4	3.5	3.6	0.134	0.137	0.142
A3	1.2	1.3	1.4	0.046	0.05	0.054
A4	0.15	0.2	0.25	0.005	0.007	0.009
a		0.2			0.007	
b	5.4	5.53	5.65	0.212	0.217	0.221
c	0.23	0.27	0.32	0.008	0.01	0.012
D	9.4	9.5	9.6	0.370	0.374	0.377
D1	7.4	7.5	7.6	0.290	0.295	0.298
E	15.15	15.4	15.65	0.595	0.606	0.615
E1	9.3	9.4	9.5	0.365	0.37	0.375
E2	7.3	7.4	7.5	0.286	0.292	0.294
E3	5.9	6.1	6.3	0.231	0.24	0.247
F		0.5			0.019	
G		1.2			0.047	
R1			0.25			0.01
R2		0.8			0.031	
T1		6 deg			6 deg	
T2		10 deg			10 deg	

Note: Resin protrusions not included (max value: 0.15 mm per side)

Figure 35. Package dimensions

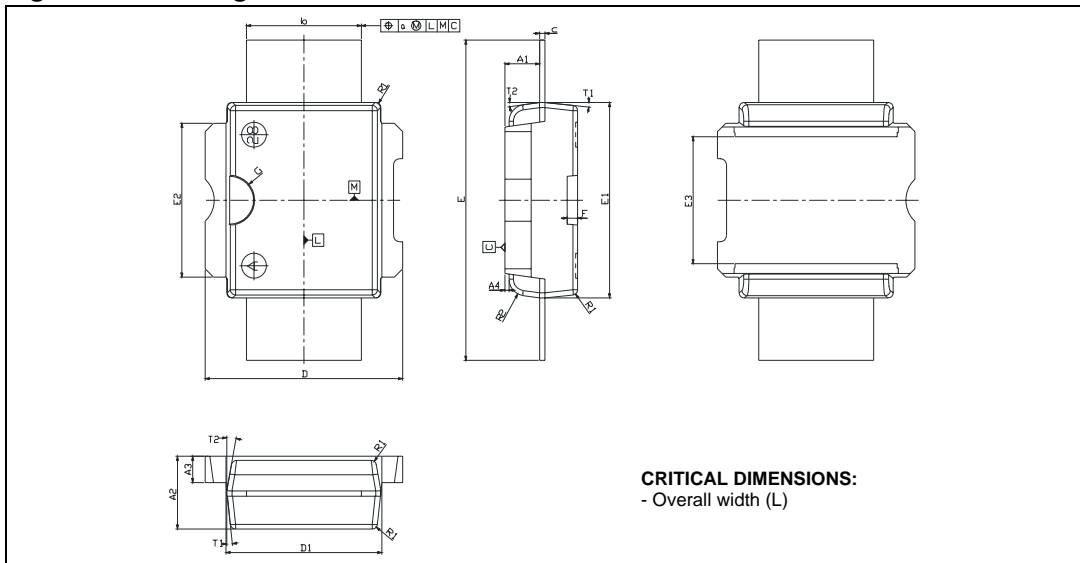
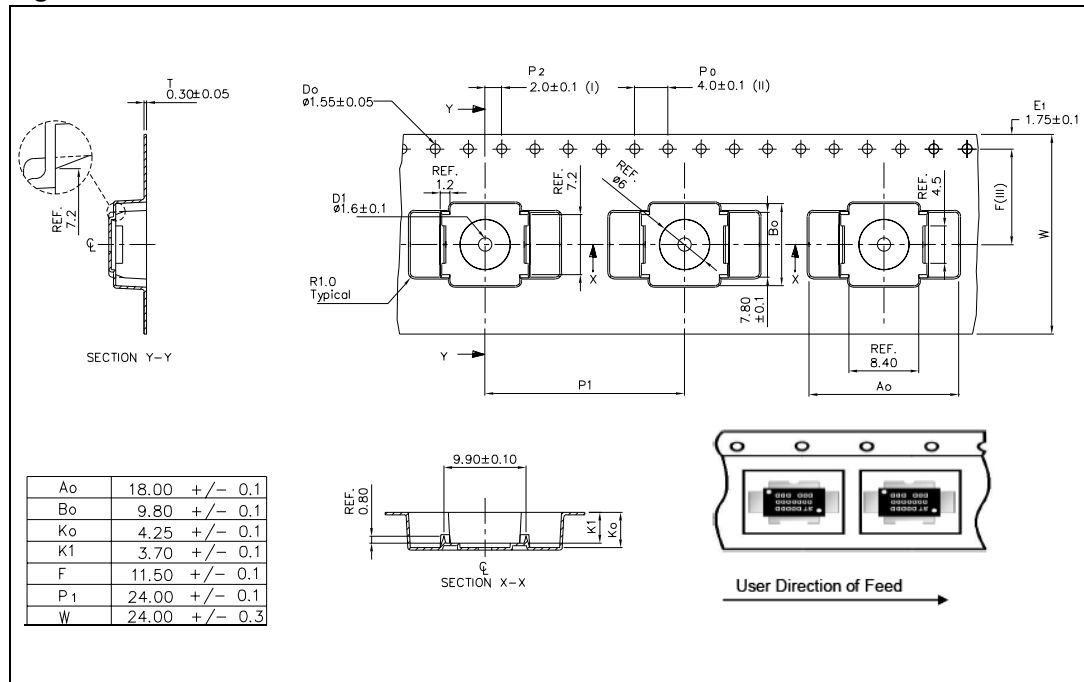

Figure 36. Tube information



Figure 37. Reel information



10 Revision history

Table 18. Document revision history

Date	Revision	Changes
21-Mar-2006	1	Initial release.
01-Aug-2007	2	Update $R_{DS(on)}$ in <i>Table 4: Static</i> .
19-May-2010	3	Added: <i>Table 6: Moisture sensitivity level</i> .
08-Aug-2011	4	Added <i>Figure 6: Maximum safe operating area</i> . Minor text changes.