

**PD70101EVB6F/
PD70101EVB3F/
PD70101EVB15F5/
PD70101EVB15F12**

Evaluation Board User Guide
Revision 1.0

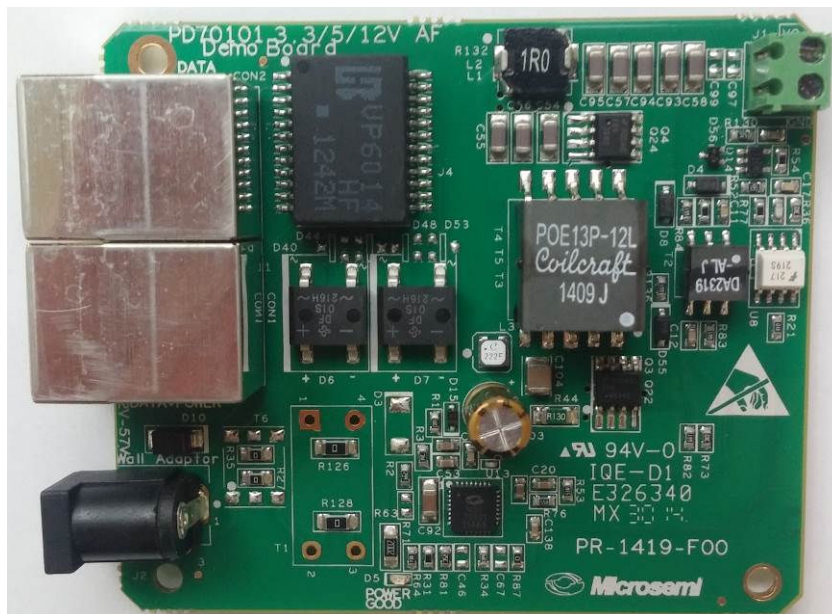



PRODUCTION DATA – Information contained in this document is proprietary to Microsemi and is current as of publication date. This document may not be modified in any way without the express written consent of Microsemi. Product processing does not necessarily include testing of all parameters. Microsemi reserves the right to change the configuration and performance of the product and to discontinue product at any time.

1 About this Guide

This user guide provides both description and operation procedures for Microsemi's PD70101EVBxF boards.

There is different User Guide for PD70101EVBxFC boards.

All of these board types are used for evaluating the performance of PD70101 PD applications.

The existing boards' types support a range of 3.3 - 13 Watts PDs with and without Standby Mode.

1.1 Audience

This user guide is intended for qualified personnel, meaning operators and technicians who have a background in basic concepts of electronics.

1.2 Organization

This guide is divided into several sections as follows:

• Chapter 1	About this Guide: Describes the objectives, audience, and organization.
• Chapter 2	Introduction: Provides an overview about evaluation board's main functions, features, physical characteristics and ordering information.
• Chapter 3	Physical Description: Provides explanation related to the physical description (switches, jumpers, connectors).
• Chapter 4	Electrical Characteristics: Provides electrical characteristics of the evaluation board.
• Chapter 5	Installation: Provides description of the installation process.
• Chapter 10	Schematic: Provides board schematic diagram
• Chapter 11	List of Materials: Provides board's list of materials.

1.3 Reference Documents

PD70101 datasheet, catalogue number DS_PD70101_70201

2 Introduction

Microsemi's PD70101EVBxF Evaluation Board (see Figure 2) provides designers with the needed environment to evaluate the performance and implementation of PD applications based on PD70101 PD-chip. The evaluation board enables PD designers to evaluate Microsemi's PD-chip solution.

All necessary steps and connection instructions required to install and operate this board are provided within this document.

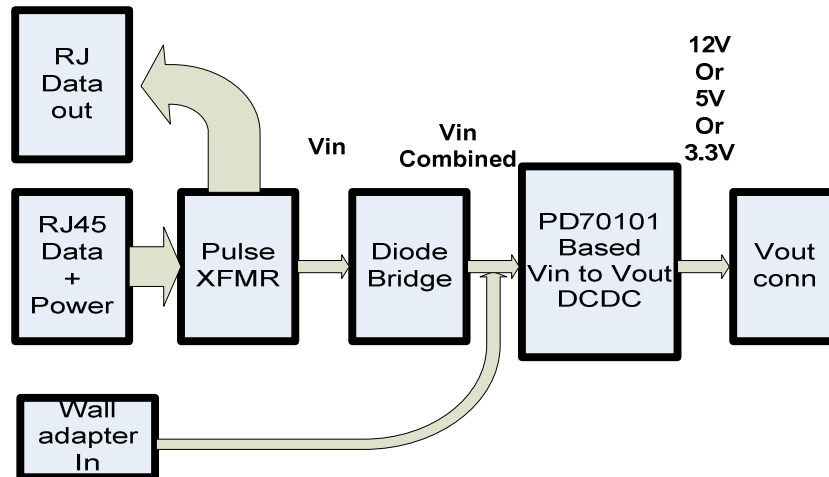

Figure 1: PD70101EVBxF Block Diagram

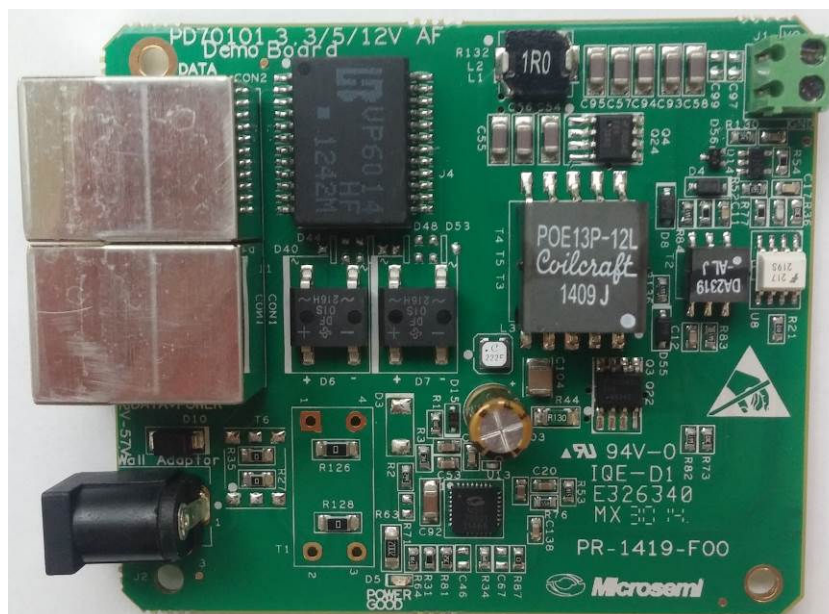

Figure 2: PD70101EVB15F12 Evaluation Board – General View

2.1 Evaluation Boards Ordering Information

Microsemi’s supplies the following Evaluation Boards:

Ordering Number	Description
PD70101EVB3F	IEEE802.3 Type 1 PD based on PD70101 device controlling an isolated flyback converter , having a 3.3V 1Amp output.
PD70101EVB6F	IEEE802.3 Type 1 PD based on PD70101 device controlling an isolated flyback converter , having a 5V 1.2Amp output.
PD70101EVB15F5	IEEE802.3 Type 1 PD based on PD70101 device controlling an isolated flyback converter , having a 5V 2.6Amp output.
PD70101EVB15F12	IEEE802.3 Type 1 PD based on PD70101 device controlling an isolated flyback converter , having a 12V 1.1Amp output.

2.2 Evaluation Board Features

- Designed to support one PD-chip application (2-pairs)
- Two RJ45 connectors (Data and Power In, Data Out)
- Optional Wall adapter – DC in connector
- Output voltage connector.
- On board LED indicator
- Pulse transformers and common mode chocks
- Evaluation Board working temperature: 0° to +70°C
- RoHS compliant
- Optional standby circuitry

2.3 Evaluation Board Interfaces and Connections

Board has several interfaces:

- **RJ45 Interface:** Running from PSE side to PD (powered device), based on PD70101 (CON1)
- **V_{in} Connectors:** DC in, alternative wall adapter connection (CON2)
- **LEDs Indication:** Power good LED indication (D5)
- **Output Voltage Connector:** 3.3V or 5V or 12V based on EVB type (J1)

2.4 Physical Characteristics

Table 1 lists evaluation board's physical characteristics.

Table 1: Physical Characteristics

Parameter	Value
Mechanical dimensions in mm	76 x 65 x 29 mm (L x W x H)

3 Physical Description

3.1 Package Contents

Upon opening the Evaluation Board package, verify the following part is included. If it seems damaged, contact the local representative or Microsemi's headquarters. Package content for standard shipments is:

- PD70101EVBxF Evaluation Board

3.2 Connectors

The following sections provide both general and detailed information regarding unit's connectors.

3.2.1 Connectors Table

Table 2 lists the Evaluation Board's connectors.

Table 2: Connectors List

#	Connector	Name	Description
1	CON1	RJ45 Connector	RJ45 port for Data and Power In for PSE connection
2	CON2	RJ45 Connectors	RJ45 port for Data Out for PD data connection
3	J2	Optional Wall Adapter	Optional DC in connection for powering the board instead of CON1. Insertion of wall adapter connector disconnects CON1.
4	J1	Converter Output	A terminal block for connecting a load to output regulator

3.2.2 Connectors Detailed Explanation

(The numbering is in reference to the numbers listed in Table 2.)

1. RJ45 Connectors (CON1)

There are two dedicated RJ45 connectors, See Figure 3.

Table 3: RJ45 Connectors

CON2 Pin No	Signal Name	Description
1, 2, 3, 4, 5, 6, 7, 8	Data Out	Data output to PD
CON1 Pin No	Signal Name	Description
1, 2	Data and Power In	Data and power input to powered device (PoE Master Negative data port)
3, 6	Data and Power In	Data and power input to powered device (PoE Master Positive data port)
4, 5	Data and Power In	Data and power input to powered device (PoE Master Negative data port)
7, 8	Data and Power In	Data and power input to powered device (PoE Master Positive data port)

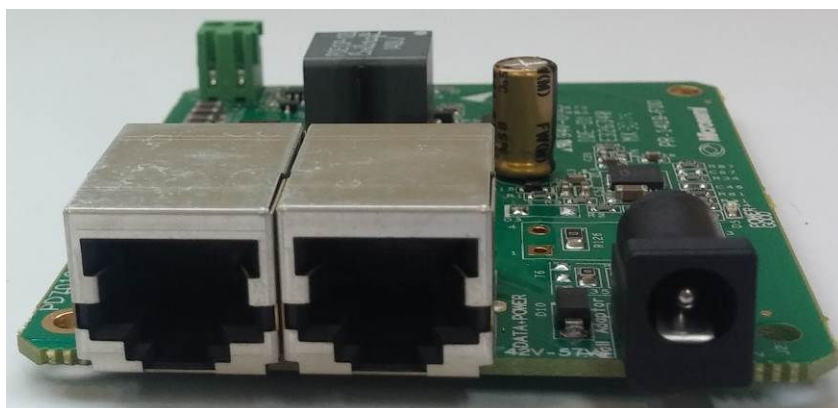

Figure 3: Front RJ45 and Wall Adapter Connectors

2. V_{in} Connectors (J2)

DC in connection can be used to power Evaluation Board instead of RJ45 PSE connection

$44V > V_{in} > 57VDC$.

Table 4: V_{in} Connectors

Pin No.	Signal Name	Description
External ring	$V_{main} (V_{in} -)$	Negative input voltage
Internal pin	$V_{main} (V_{in} +)$	Positive input voltage

- Manufacturer: **TAI CHUNG ELECTRONIC COMPONENT PARTS CO., LTD.**
- Manufacture part number: **TC18-013-02**

3. V_{out} Connectors

See Figure 4.

J1 –DCDC output connection, used for connecting to external load.

Table 5: J1 Connectors

Pin No.	Signal Name	Description
1 – Left	V _{out}	Positive DCDC output voltage
2 – Right	GND	Return of DCDC output voltage

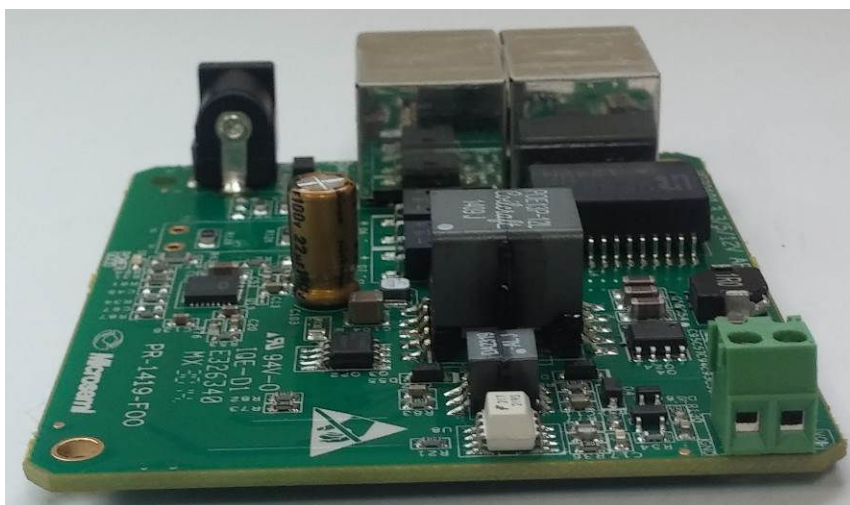

Figure 4: V_{out} Connectors

4. LED Indication

See Figure 5.

D5 is the Power_GOOD indication LED, a PD70101 device output signal indicating device's isolation switch is operated.

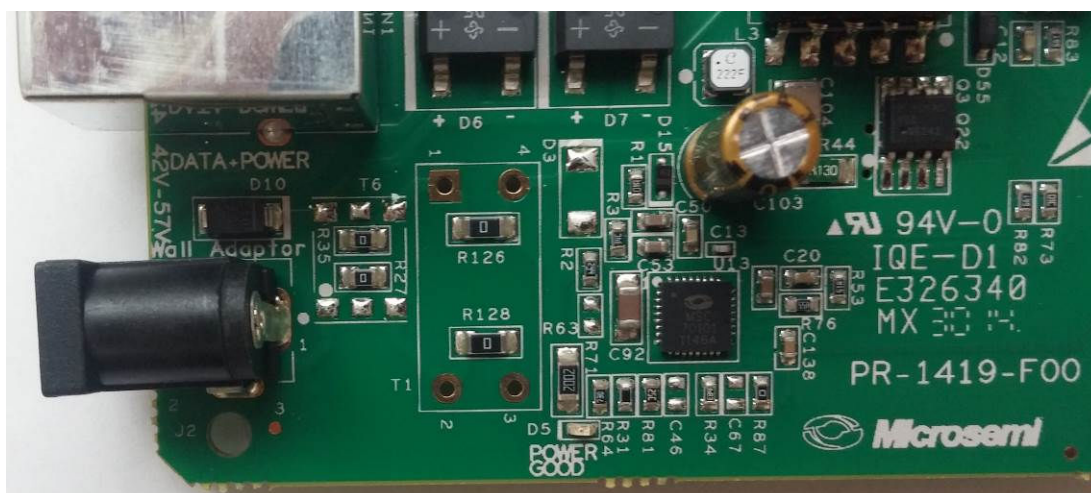

Figure 5: Power_Good LED Indication

4 Electrical Characteristics

Evaluation board's electrical characteristics are described below:

Table 6: Electrical Characteristics

Parameter	Symbol	Min.	Max.	Units
Main DC Supply – V_{main}		44	57	V
Port Isolation to Chassis		-	1.5	kVrms
All Communication's Isolation to Chassis		-	1.5	kVrms

5 Installation

This chapter describes the steps required to install and operate Evaluation Board with any PoE application.

5.1 Preliminary Considerations and Safety Precautions

Verify board's power supply is turned on before peripheral devices are turned on.

5.2 Initial Configuration

Note: It is important to verify Evaluation Board is setup as shown in Figure 6 prior to starting any operation.

1. Connect load to main board (J1).
2. Connect a power cable from power supply to Evaluation Board (CON1).
3. Connect Ethernet Cable from Evaluation Board (CON2) to Ethernet Host.

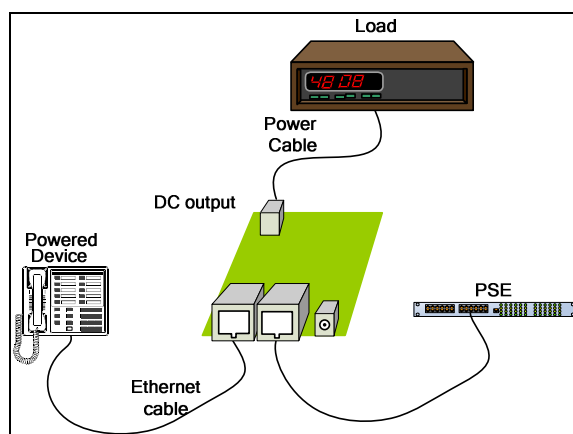

Figure 6: Test Setup

6 PD70101EVB6F Efficiency

This chapter describes EVB efficiency under various loads and POE input voltage levels.

The information is presented by two modes:

Total Eff – Efficiency measured between RJ45 input Connector and Output voltage connector

$$Total\ Eff = \frac{V_{out} * I_{out}}{V_{in} * I_{in}}$$

PD+DCDC Eff – Efficiency measured between Diode bridge output and Output voltage connector. It does not include the losses of the input connector, line transformer and diode bridges.

$$PD_DCDC\ Eff = \frac{V_{out} * I_{out}}{V_{ppout} * I_{in}}$$

6.1 Efficiency for 37.5V Input at the Input Connector

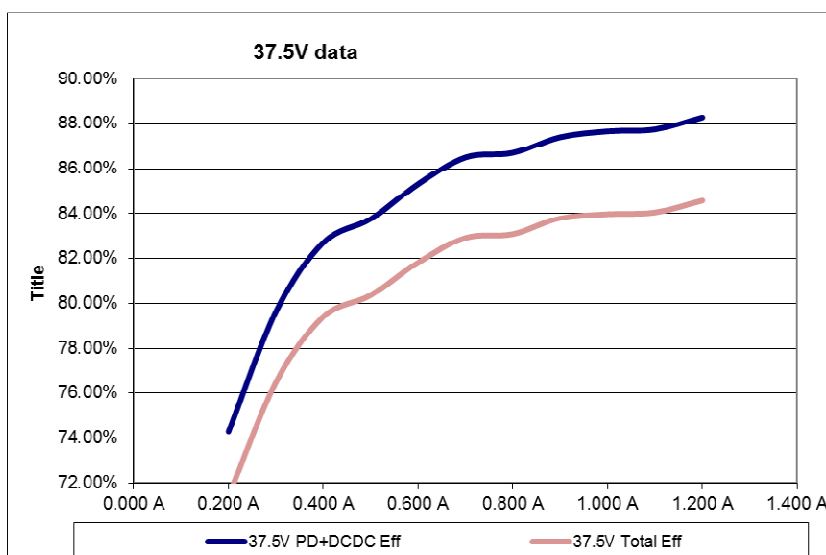

Figure 7: PD70101EVB6F Efficiency at 37.5V

6.2 Efficiency for 48V Input at the Input Connector

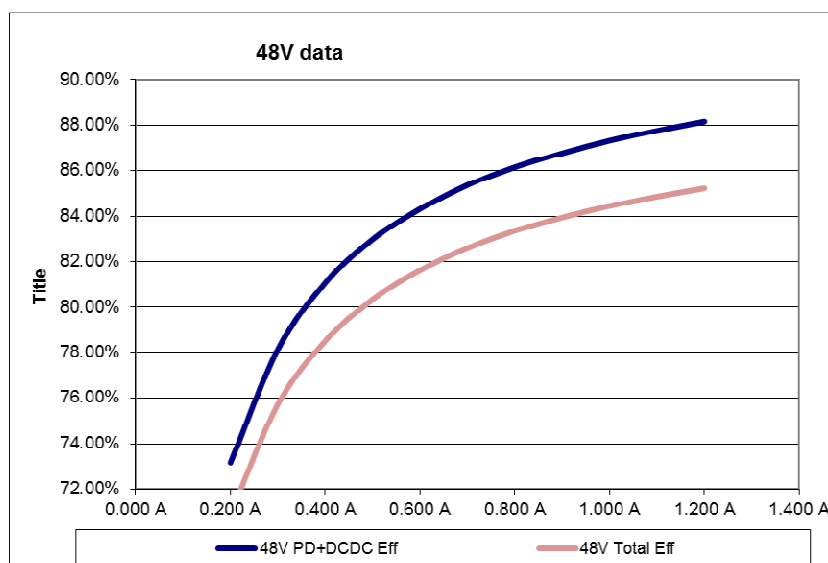

Figure 8: PD70101EVB6F Efficiency at 48V

6.3 Efficiency for 57V Input at the Input Connector

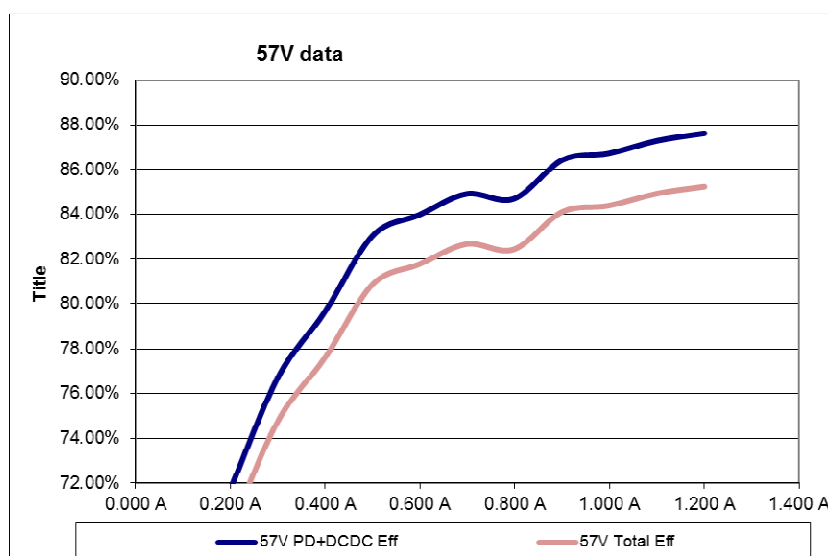

Figure 9: PD70101EVB6F Efficiency at 57V

6.4 Comparison of PD+DCDC Efficiency

Comparison of PD+DCDC Efficiency for the three above input connector voltages.

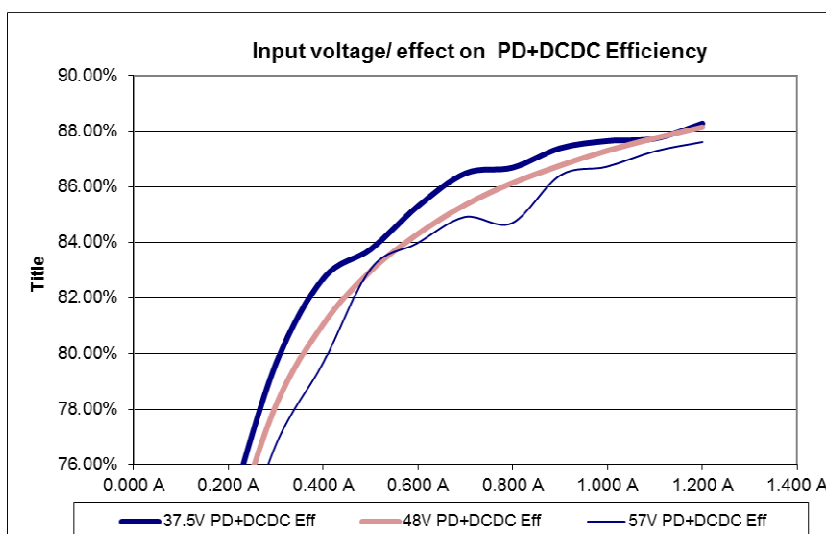

Figure 10: PD70101EVB6F PD+DCDC Efficiency for 3 Vin Values

6.5 Efficiency for Maximum Power as a Function of the Input Connector Voltage

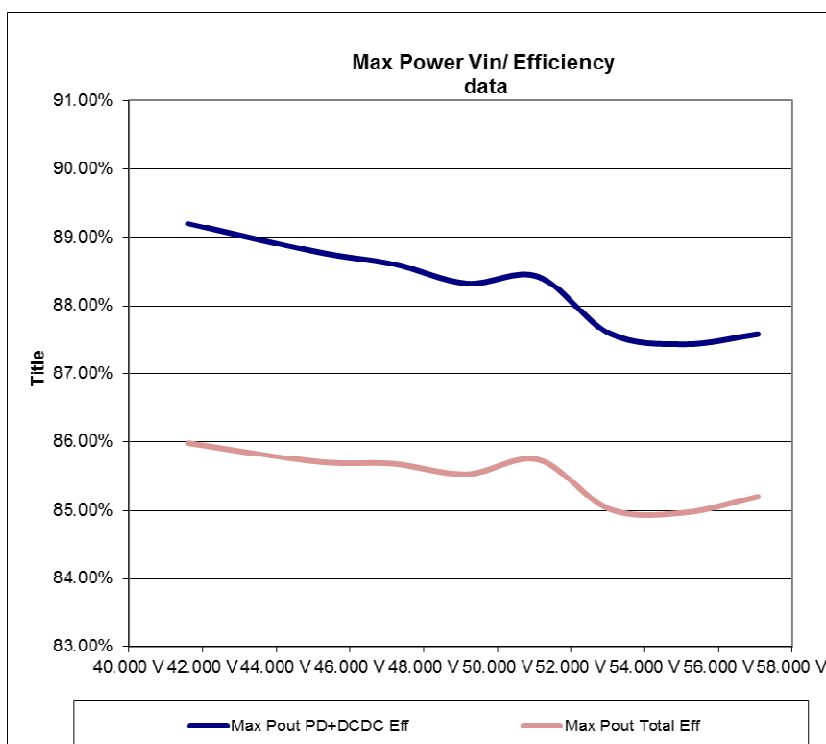

Figure 11: PD70101EVB6F Efficiency for Vin

7 PD70101EVB3F Efficiency

This chapter describes EVB efficiency under various loads and POE input voltage levels.

The information is presented by two modes:

Total Eff – Efficiency measured between RJ45 input Connector and Output voltage connector

$$Total\ Eff = \frac{V_{out} * I_{out}}{V_{in} * I_{in}}$$

PD+DCDC Eff – Efficiency measured between Diode bridge output and Output voltage connector. It does not include the losses of the input connector, line transformer and diode bridges.

$$PD_DCDC\ Eff = \frac{V_{out} * I_{out}}{V_{ppout} * I_{in}}$$

7.1 Efficiency for 37.5V Input at the Input Connector

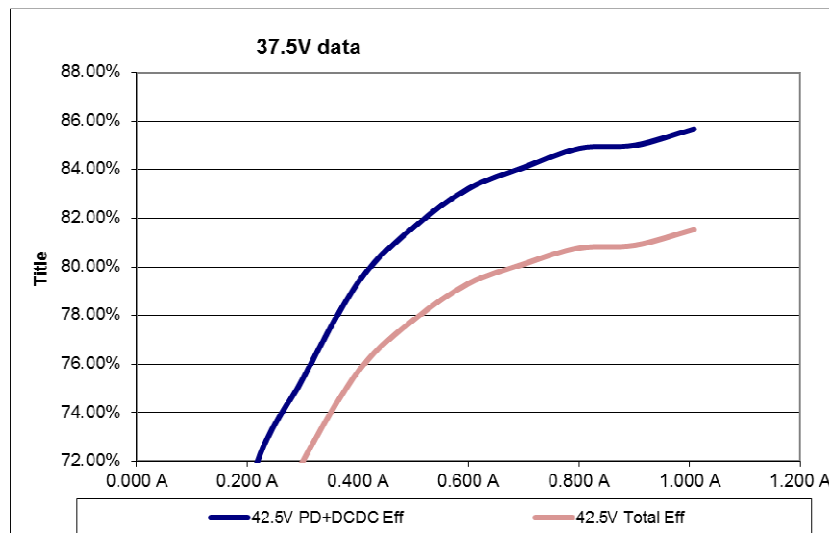

Figure 12: PD70101EVB3F Efficiency at 37.5V

7.2 Efficiency for 48V Input at the Input Connector

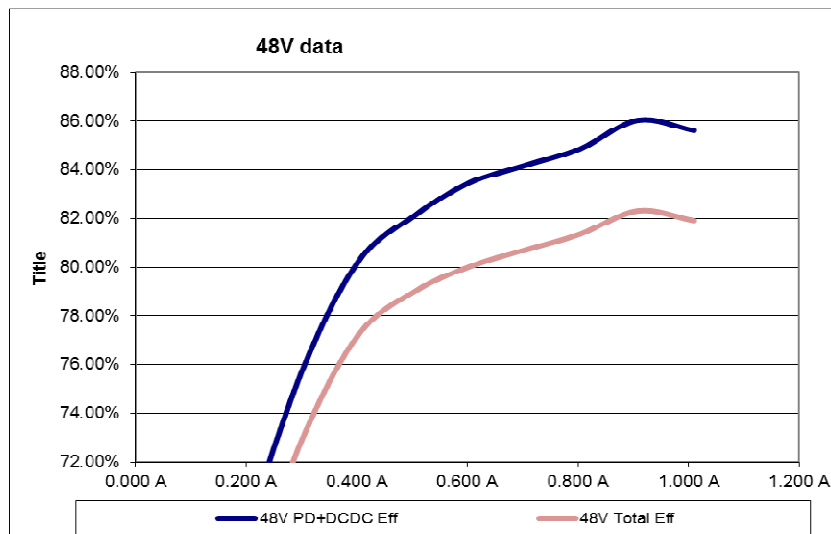

Figure 13: PD70101EVB3F Efficiency at 48V

7.3 Efficiency for 57V Input at the Input Connector

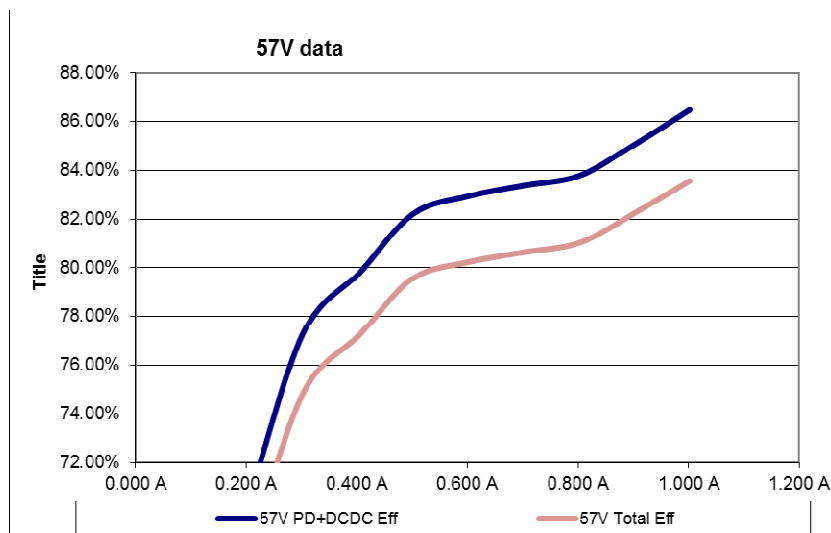

Figure 14: PD70101EVB3F Efficiency at 57V

7.4 Comparison of PD+DCDC Efficiency

Comparison of PD+DCDC Efficiency for the three above input connector voltages.

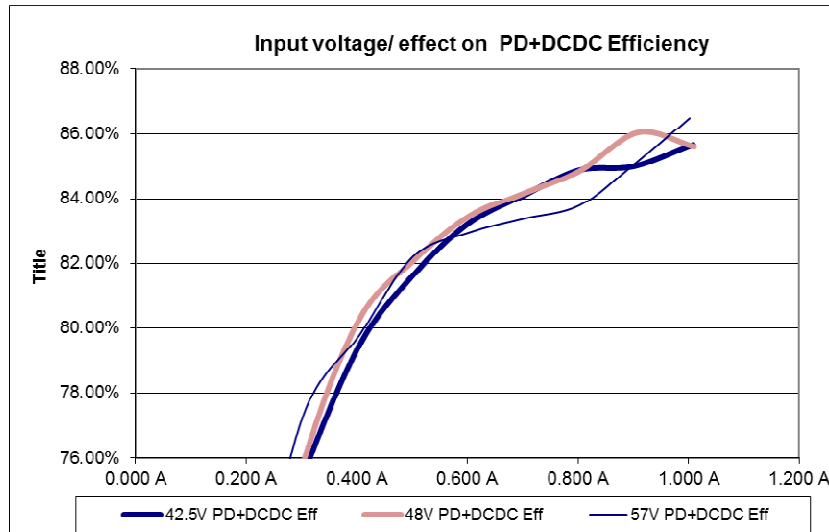

Figure 15: PD70101EVB3F PD+DCDC Efficiency for 3 Vin Values

8 PD70101EVB15F5 Efficiency

This chapter describes EVB efficiency under various loads and POE input voltage levels.

The information is presented by two modes:

Total Eff – Efficiency measured between RJ45 input Connector and Output voltage connector

$$Total\ Eff = \frac{V_{out} * I_{out}}{V_{in} * I_{in}}$$

PD+DCDC Eff – Efficiency measured between Diode bridge output and Output voltage connector. It does not include the losses of the input connector, line transformer and diode bridges.

$$PD_DCDC\ Eff = \frac{V_{out} * I_{out}}{V_{ppout} * I_{in}}$$

8.1 Efficiency for 37.5V Input at the Input Connector

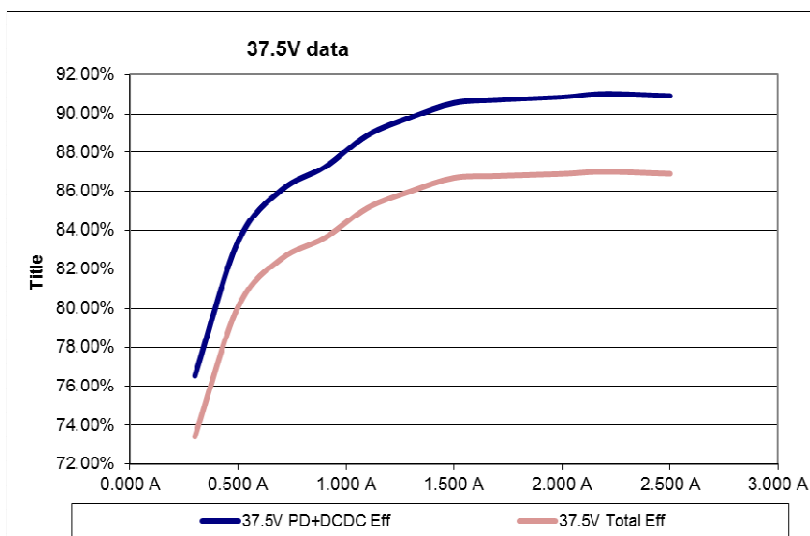

Figure 16: PD70101EVB15F5 Efficiency at 37.5V

8.2 Efficiency for 48V Input at the Input Connector

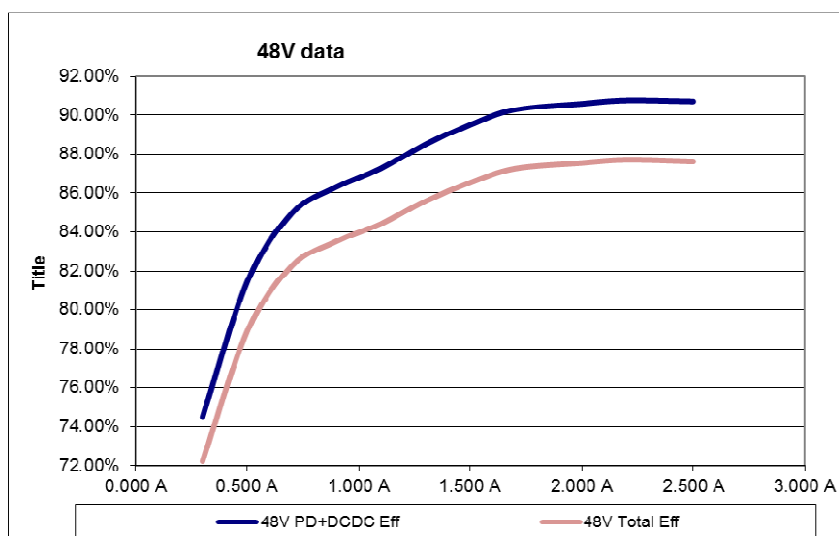

Figure 17: PD70101EVB15F5 Efficiency at 48V

8.3 Efficiency for 57V Input at the Input Connector

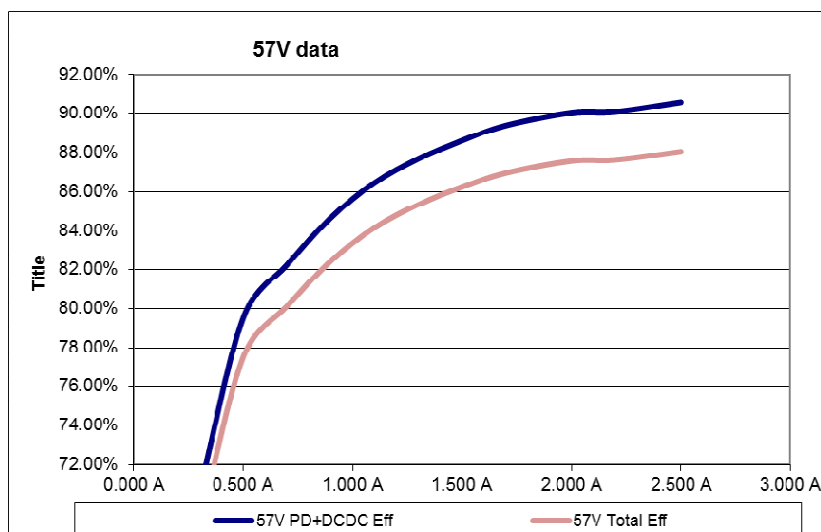

Figure 18: PD70101EVB15F5 Efficiency at 57V

8.4 Comparison of PD+DCDC Efficiency

Comparison of PD+DCDC Efficiency for the three above input connector voltages.

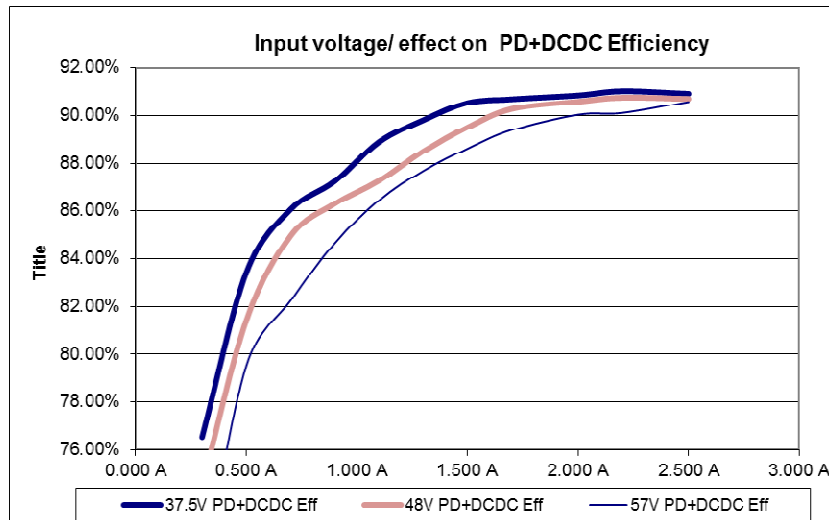

Figure 19: PD70101EVB15F5 PD+DCDC Efficiency for 3 Vin Values

8.5 Efficiency for Maximum Power as a Function of the Input Connector Voltage

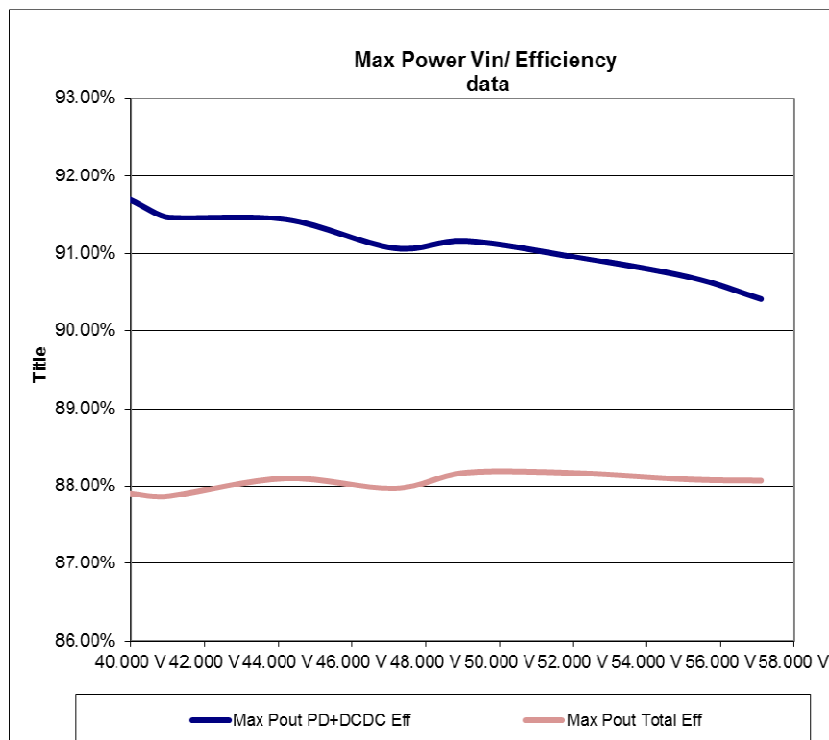

Figure 20: PD70101EVB15F5 Efficiency for Vin

9 PD70101EVB15F12 Efficiency

This chapter describes EVB efficiency under various loads and POE input voltage levels.

The information is presented by two modes:

Total Eff – Efficiency measured between RJ45 input Connector and Output voltage connector

$$Total\ Eff = \frac{V_{out} * I_{out}}{V_{in} * I_{in}}$$

PD+DCDC Eff – Efficiency measured between Diode bridge output and Output voltage connector. It does not include the losses of the input connector, line transformer and diode bridges.

$$PD_DCDC\ Eff = \frac{V_{out} * I_{out}}{V_{ppout} * I_{in}}$$

9.1 Efficiency for 37.5V Input at the Input Connector

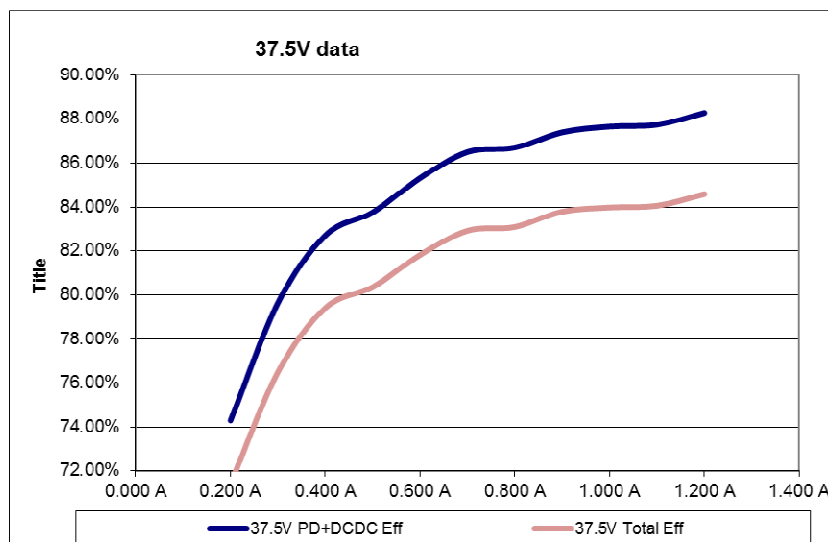

Figure 21: PD70101EVB15F12 Efficiency at 37.5V

9.2 Efficiency for 48V Input at the Input Connector

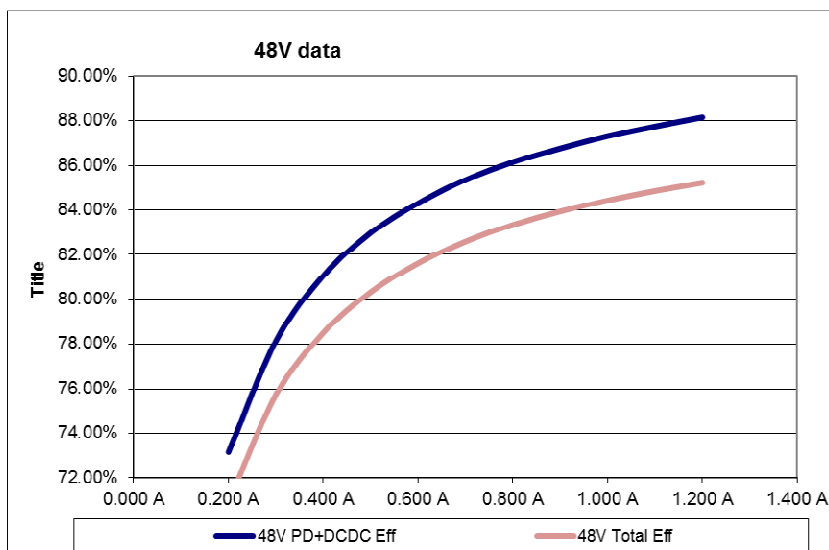

Figure 22: PD70101EVB15F12 Efficiency at 48V

9.3 Efficiency for 57V Input at the Input Connector

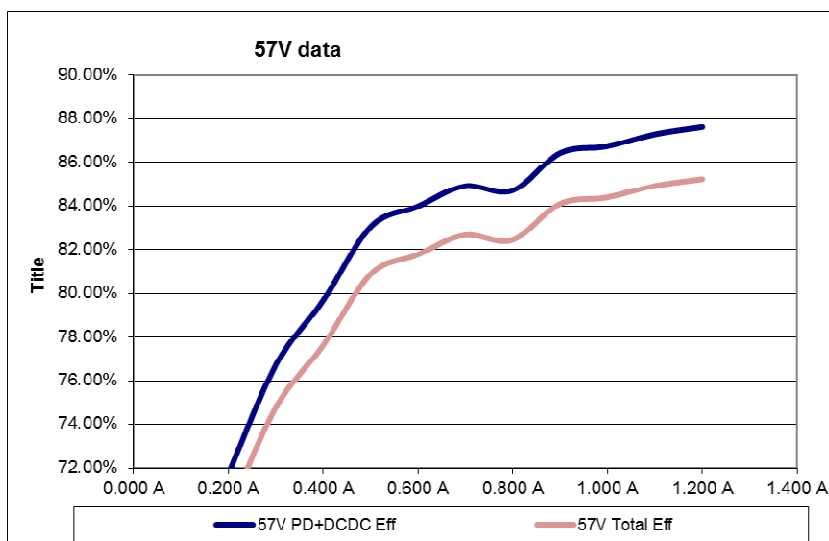

Figure 23: PD70101EVB15F12 Efficiency at 57V

9.4 Comparison of PD+DCDC Efficiency

Comparison of PD+DCDC Efficiency for the three above input connector voltages.

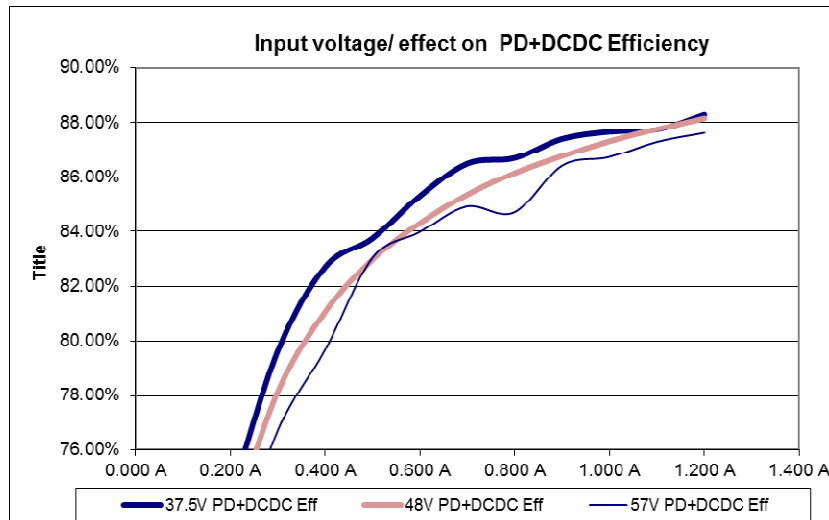

Figure 24: PD70101EVB15F12 PD+DCDC Efficiency for 3 Vin Values

9.5 Efficiency for Maximum Power as a Function of the Input Connector Voltage

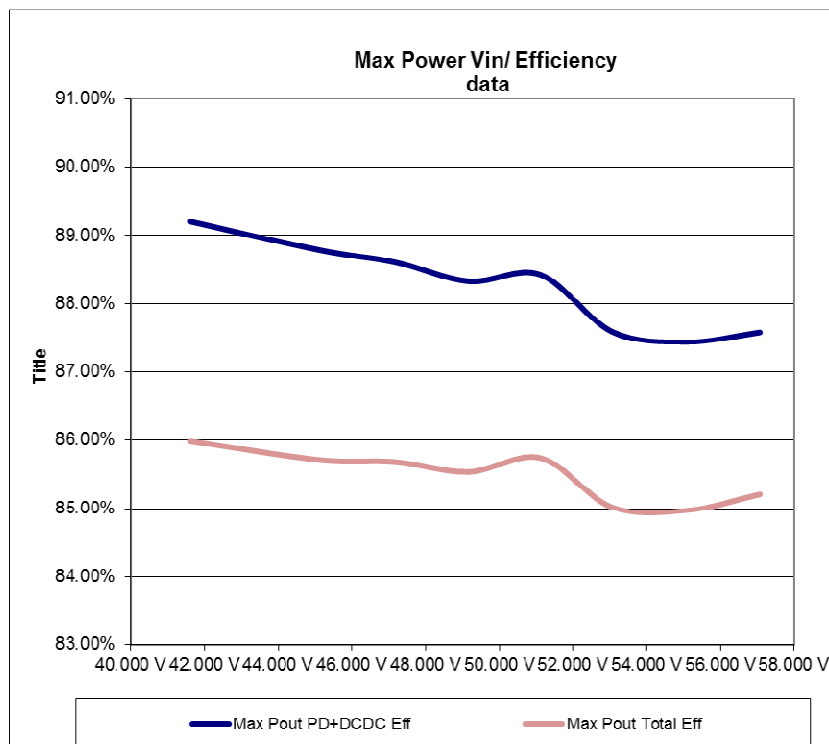
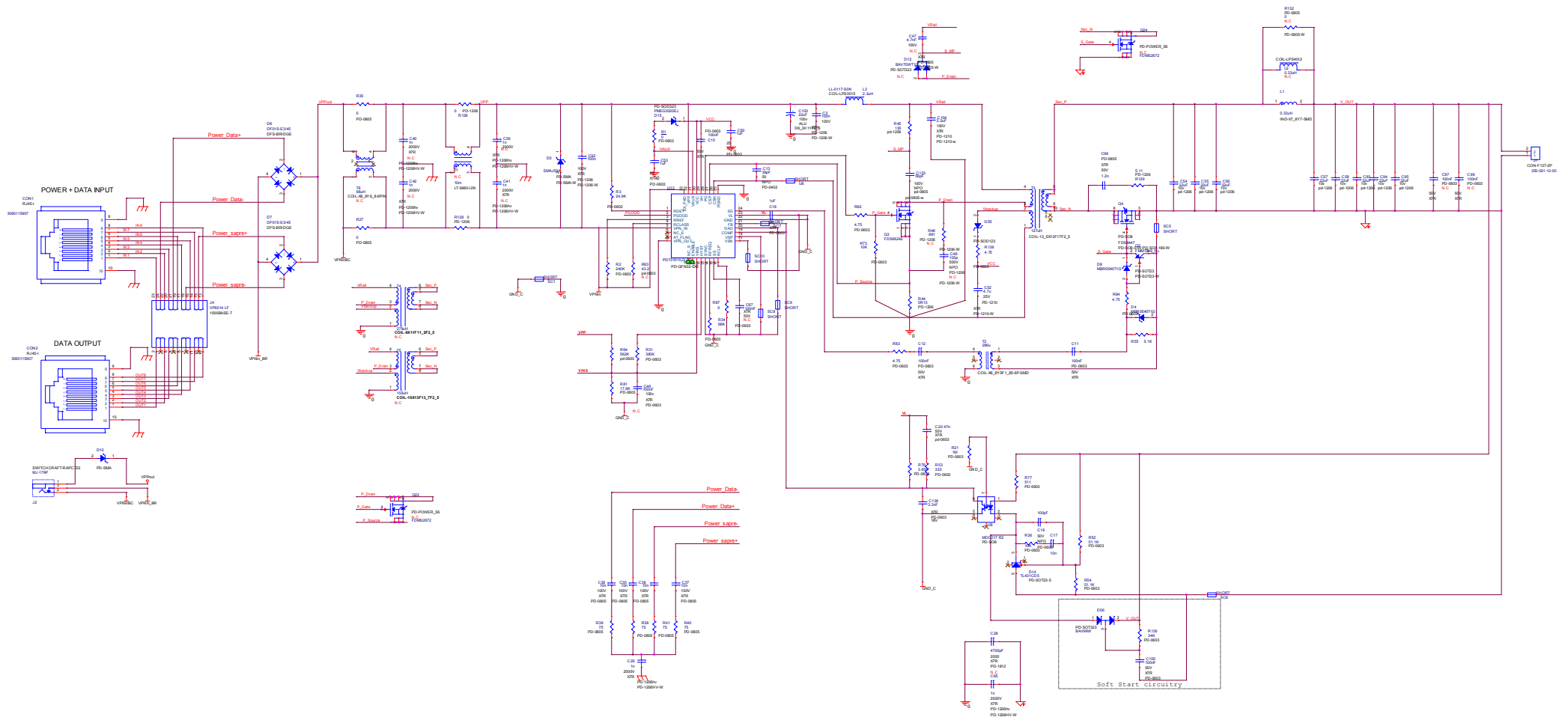

Figure 25: PD70101EVB15F12 Efficiency for Vin



10 Schematics





11 List of Materials

- First table specifies PD70101EVB6F devices.
- Second table specifies PD70101EVB3F devices.
- Third table specifies PD70101EVB15F5 devices.
- Fourth table specifies PD70101EVB15F12 devices.

Table 7: PD70101EVB6F Assembly

Item	Description	Qty	Ref Des	Mfr. Name	Mfr. Part Number
1	AF POE PD controller for IEEE 802.3 PD70101	1	U13	Microsemi	PD70101LQ-TR.
2	CAP CRM 100pF 200V 10% NPO 0805 SMT	1	C133	AVX	08052A101KAT2A
3	CAP CRM 1.2nF 50V 10% X7R 0805 SMT	1	C96	AVX	08055C122KAT2A
4	CAP CRM 10nF 100V 5% X7R 0805 SMT	4	C35-C38	AVX	08051C103JAT2A
5	CAP CRM 22uF 10V 20% X5R 1206 SMT	5	C54,C55,C93-C95	AVX	1206ZD226MAT2A
6	CAP CRM 1nF/2000V 10%++X7R 1206 SMT	2	C29,C65	AVX	1206GC102KAT1A
7	CAP CRM 100nF 100V 10% X7R 1206 SMT	2	C3,C92	AVX	12061C104KAT2A
8	CAP CER 39PF 50V 5% C0G 0402	1	C13	AVX	04025A390JAT2A
9	CAP CER 2.2uF 100V 10% X7R 1210 SMT	1	C104	CAPAX	1210X225K101SNT
10	CAP CRM 22uF 25V 20% 1210 X7R SMT	1	C52	Murata	GRM32ER71E226ME15L
11	CAP COG 100pF 50V 5% 0603	1	C19	AVX	06035A101JAT2A
12	Capacitor, X7R, 3.3nF, 16V, 10% 0603	1	C138	Murata	GRM188R71H332KA01
13	CAP CRM 100nF 50v 10% X7R 0603	4	C11,C12,C15,C100	Meritek	MA0603XR104K500
14	Capacitor, X7R, 47nF, 50V, 10% 0603	1	C20	AVX	06035C473KAT2A
15	Capacitor,X7R, 1uF, 25V, 10% 0603	3	C18,C50,C53	Murata	GRM188R71E105KA12D
16	CAP CRM 10nF 50v 10% X7R 0603 SMT	1	C17	Murata	GRM188R71H103KA01
17	CAP ALUM 22UF 100V 20% 6.3X11 P=2.5	1	C103	Nichicon	UFW2A220MED
18	CON RJ45 SINGLE 8 POS. SHILDED	2	CON1,CON2	Bel Stewart	SS71800-007F
19	CON DC POWER JACK RA 2.0X6.3 T/H	1	J2	Shogyo Int Corp.	MJ-179P
20	Terminal block 2 3.5mm pitch	1	J1	DECA	MB332-350M02
21	Diode, Dual Switching BAV99W SOT323	1	D56	Diodes Inc.	BAV99W-7-F
22	Diode, Switching, 200V, 500mA,SOD123	1	D55	Rohm	RF071M2S
23	DIO BRIDGE 100V 1A SMT	2	D6,D7	Vishay	DF01S-E3/45
24	DIO SCHOTTKY 90V 1A SMA REC SMT	1	D10	Vishay	SS1H10-E3
25	DIO SCHOTTKY 30V 2A SOD323F SMT	1	D15	NXP	PMEG3020EJ
26	DIO SCHOTTKY 40V 500mA SOD123 REC. SMT	2	D4,D8	ON Semiconductor	MBR0540T1G
27	IC Prog Shunt Ref 2.5V 2% SOT23-5 SMT	1	D14	Philips	TL431CD5
28	IC, N-CH POWER MOSFET 150v 4.1A SO8	1	Q3	Fairchild	FDS86242
29	1000 BASET SINGLE PORT MAGNETICS SMT	1	J4	BOTHHAND	VP6014 HF



PD70101EVBxF Evaluation Board – User Guide

30	Power Inductors 2.2uHy 1.5A 110mOhm SMT Shilded	1	L3	Coilcraft	LPS3015-222MR
31	Power Inductors 0.33uHy 4*4mm SMT Shilded	1	L2	Coilcraft	LPS4012-331MR
32	Transformer, Gate driver SMT 269uH 0.795 DCR	1	T2	Coilcraft	DA2319-AL
33	Flyback Transformers 155uH 5V 1.4A SMT	1	T5	Coilcraft	POE70P-50L
34	LED SuperYelGm 100-130o 20-40mcd h=1 0603 SMD	1	D5	Everlight	19-21-SYGCS530E3TR8
35	IC OPTOISOLATOR MOC217	1	U8	Fairchild	MOC217R2-M
36	PCB Mrk Cisco 5V/6W/90perc Flyback EVB	1	PCB	IQE	PR-1419-F00-IQ
37	RES TCK FLM 0R 125mW 5% 0805 SMT	2	R27,R35	Bourns	CR0805-J/-000-ELF
38	RES 75R 125mW 1% 0805 SMT	4	R38-R41	Bourns	CR0805-FX-75R0-ELF
39	RES 0R 250mW 5% 1206 SMT JUMPER<0.05R	2	R126,R128	Samsung	RC3216J000CS
40	RES 0.25 OHM 1/2W 1% 1206 SMT	1	R44	IRC	LRC-LR1206LF-01-R250F
41	RES 5.11R 250mW 1% 1206 SMT	1	R129	Samsung	RC3216F5R11CS
42	RES TCK FLM 100R 250mW 1% 1206 SMT	1	R45	Bourns	CR1206-FX-1000-ELF
43	RES TK FLM 20K 250mW 1% 1206	1	R71	Bourns	CR1206-FX-2002-ELF
44	RES TCK FLM 0R 62.5mW 5% 0603 SMT	1	R87	ASJ	CR16-000ZL
45	RES TCK FLM 24.9K 62.5mW 1% 0603 SMT	1	R3	ASJ	CR16-2492FL
46	Resistor, 18.7K, 1%, 1/16W 0603	1	R81	ASJ	CR16-1872FL
47	Resistor, 68K, 5%, 1/16W 0603	1	R34	ASJ	CR16-683JL
48	Resistor, 30.9R 1%, 1/10W 0603	1	R136	KOA	RK73H1JTDD30R9F
49	RES TCK FLM 5.1K 62.5mW 1% 0603 SMT	1	R55	ASJ	CR16-5101FL
50	RES 562K, 1%, 1/16W, 0603	2	R31,R64	ASJ	CR16-5623FL
51	RES 3.65K 0.1W 1% 0603 SMT MTL FLM	1	R76	ASJ	CR16-3651-FL
52	Resistor, 240K, 1%, 1/10W 0603	1	R2	KOA	RK73H1JTDD2403F
53	RES 64.9 OHM 1/10W 1% 0603 SMT	1	R63	KOA	RK73H1JTDD64R9F
54	RES 4.75R 0.1W 1% 0603 SMT MTL FLM	3	R82-R84	Samsung	RC1608F4R75CS
55	RES 332R 62.5mW 1% 0603 SMT MTL FLM	1	R53	ASJ	CR16-3320FL
56	RES 511R 100mW 1% 0603 SMT MTL FLM 100 ppm	1	R77	Panasonic	ERJ3EKF5110V
57	RES 1.21K 100mW 1% 0603 SMT	1	R1	PDC	FCR03-F-T-1K21
58	RES 10K 62.5mW 1% 0603 SMT MTL FLM	2	R36,R73	ASJ	CR16-1002FL
59	RES 34K 62.5mW 1% 0603 SMT	1	R130	Samsung	RC1608F3402CS
60	RES 51.1K 62.5mW 1% 0603 SMT MTL FLM	2	R52,R54	ASJ	CR16-5112FL
61	RES 1M 62.5mW 1% 0603 SMT MTL FLM	1	R21	ASJ	CR16-1004-FL
62	TRN PNP -30V -1A SOT23	1	Q2	Fairchild	FMMT549
63	MOSFET N-CH 40V 12.8A 8-SOIC SMT	1	Q4	Fairchild	FDS8447



PD70101EVBxF Evaluation Board – User Guide

Table 8: PD70101EVB3F Assembly

Item	Description	Qty	Ref Des	Manufacturer	Manufacturer PN
1	AF POE PD controller for IEEE 802.3 PD70101	1	U13	Microsemi	PD70101ILQ-TR.
2	CAP CRM 56pF 100V 5% NPO 0805 SMT	1	C133	AVX	08051A560JAT2A
3	CAP CRM 1.2nF 50V 10% X7R 0805 SMT	1	C96	AVX	08055C122KAT2A
4	CAP CRM 10nF 100V 5% X7R 0805 SMT	4	C35-C38	AVX	08051C103JAT2A
5	CAP CRM 22uF 6.3V 20% X7R 1206 SMT	5	C54,C55,C93-C95	AVX	12066C226MAT2A
6	CAP CRM 1nF/2000V 10%++X7R 1206 SMT	2	C29,C65	AVX	1206GC102KAT1A
7	CAP CRM 100nF 100V 10% X7R 1206 SMT	2	C3,C92	AVX	12061C104KAT2A
8	CAP CER 39PF 50V 5% C0G 0402	1	C13	AVX	04025A390JAT2A
9	Capacitor, X7R, 4.7uF, 25V, 10% 1210	1	C52	Murata	GRM32DR71E475KA61L
10	CAP CER 2.2uF 100V 10% X7R 1210 SMT	1	C104	CAPAX	1210X225K101SNT
11	CAP COG 100pF 50V 5% 0603	1	C19	AVX	06035A101JAT2A
12	Capacitor, X7R, 3.3nF, 16V, 10% 0603	1	C138	Murata	GRM188R71H332KA01
13	CAP CRM 100nF 50v 10% X7R 0603	4	C11,C12,C15,C100	Meritek	MA0603XR104K500
14	Capacitor, X7R, 47nF, 50V, 10% 0603	1	C20	AVX	06035C473KAT2A
15	Capacitor,X7R, 1uF, 25V, 10% 0603	3	C18,C50,C53	Murata	GRM188R71E105KA12D
16	CAP CRM 10nF 50v 10% X7R 0603 SMT	1	C17	Murata	GRM188R71H103KA01
17	CAP ALUM 18UF 100V 20% RADIAL	1	C103	Nichicon	UPW2A180MED
18	CON RJ45 SINGLE 8 POS. SHILDED	2	CON1,CON2	Bel Stewart	SS71800-007F
19	CON DC POWER JACK RA 2.0X6.3 T/H	1	J2	Shogyo Int Corp.	MJ-179P
20	Terminal block 2 Pole interlocking 3.5mm pitch	1	J1	DECA	MB332-350M02
21	Diode, Dual Switching BAV99W SOT323	1	D56	Diodes Inc.	BAV99W-7-F
22	DIO BRIDGE 100V 1A SMT	2	D6,D7	Vishay	DF01S-E3/45
23	DIO SCHOTTKY 90V 1A SMA REC SMT	1	D10	Vishay	SS1H10-E3
24	DIO SCHOTTKY 30V 2A SOD323F SMT	1	D15	NXP	PMEG3020EJ
25	DIODE SCHOTTKY 70V 0.2A,225 W, SOD123	1	D55	ON Semiconductor	MMSD701T1G
26	DIO SCHOTTKY 40V 500mA SOD123 REC. SMT	2	D4,D8	ON Semiconductor	MBR0540T1G
27	IC PROG. SHUNT REGULATOR 1.25V SOT23-5 1% SMT	1	D14	National	LMV431AIM5/NOPB
28	IC, N-CH POWER MOSFET 150v 4.1A SO8	1	Q3	Fairchild	FDS86242
29	1000 BASET SINGLE PORT MAGNETICS SMT	1	J4	BOTHHAND	VP6014 HF
30	Transformer, Gate driver SMT 269uH 0.795 DCR	1	T2	Coilcraft	DA2319-AL
31	Flyback Transformers 279uH 3.3V 0.91A SMT	1	T4	Coilcraft	POE30P-33L



PD70101EVBxF Evaluation Board – User Guide

32	LED SuperYelGm 100-130o 20-40mcd h=1 0603 SMD	1	D5	Everlight	19-21-SYGCS530E3TR8
33	IC OPTOISOLATOR MOC217	1	U8	Fairchild	MOC217R2-M
34	RES TCK FLM 0R 125mW 5% 0805 SMT	3	R27,R35,R132	Bourns	CR0805-J/-000-ELF
35	RES 75R 125mW 1% 0805 SMT	4	R38-R41	Bourns	CR0805-FX-75R0-ELF
36	RES 0R 250mW 5% 1206 SMT JUMPER<0.05R	2	R126,R128	Samsung	RC3216J000CS
37	RES 0.360R 0.5W 1% 1206 200 ppm SMT	1	R44	Susumu Co.	RL1632R-R360-F
38	RES 5.11R 250mW 1% 1206 SMT	1	R129	Samsung	RC3216F5R11CS
39	RES 130R 250mW 1% 1206 SMT MTL FLM	1	R45	KOA	RK73H2BTDD1300F
40	RES TK FLM 20K 250mW 1% 1206	1	R71	Bourns	CR1206-FX-2002-ELF
41	RES TCK FLM 0R 62.5mW 5% 0603 SMT	2	R1,R87	ASJ	CR16-000ZL
42	RES 17.8K 1% 1/16W 0603 SMT MTL FLM	1	R81	ASJ	CR16-1782FL
43	RES TCK FLM 24.9K 62.5mW 1% 0603 SMT	1	R3	ASJ	CR16-2492FL
44	RES 383K 100mW 1% 0603SMT MTL FLM	1	R31	ASJ	CR16-3833FL
45	Resistor, 68K, 5%, 1/16W 0603	1	R34	ASJ	CR16-683JL
46	Resistor, SMT 113 Ohm, 1%, 1/10W 0603	1	R63	ASJ	CR16-1130FL
47	RES TCK FLM 5.1K 62.5mW 1% 0603 SMT	1	R55	ASJ	CR16-5101FL
48	RES 562K, 1%, 1/16W, 0603	1	R64	ASJ	CR16-5623FL
49	RES 3.65K 0.1W 1% 0603 SMT MTL FLM	1	R76	ASJ	CR16-3651-FL
50	Resistor, 240K, 1%, 1/10W 0603	1	R2	KOA	RK73H1JTDD2403F
51	RES 4.75R 0.1W 1% 0603 SMT MTL FLM	4	R82-R84,R136	Samsung	RC1608F4R75CS
52	RES 332R 62.5mW 1% 0603 SMT MTL FLM	2	R53,R77	ASJ	CR16-3320FL
53	RES 10K 62.5mW 1% 0603 SMT MTL FLM	2	R36,R73	ASJ	CR16-1002FL
54	RES 30.1K 62.5mW 1% 0603 SMT MTL FLM	1	R54	ASJ	CR16-3012FL
55	RES 34K 62.5mW 1% 0603 SMT	1	R130	Samsung	RC1608F3402CS
56	RES 51.1K 62.5mW 1% 0603 SMT MTL FLM	1	R52	ASJ	CR16-5112FL
57	RES 1M 62.5mW 1% 0603 SMT MTL FLM	1	R21	ASJ	CR16-1004-FL
58	TRN PNP -30V -1A SOT23	1	Q2	Fairchild	FMMT549
59	FET NCH 30V 7A SO8 SMT 2.5W 0.03R	1	Q4	I.R.	IRF7201 PBF
60	DIO TVS 58V 40A SRG 400WPK SMA SMT	1	D3	Diodes Inc.	SMAJ58A



PD70101EVBx F Evaluation Board – User Guide

Table 9: PD70101EVB15F5 Assembly

Item	Description	Qty	Ref Des	Manufacturer	Manufacturer PN
1	AF POE PD controller for IEEE 802.3 PD70101	1	U13	Microsemi	PD70101ILQ-TR.
2	CAP CRM 56pF 100V 5% NPO 0805 SMT	1	C133	AVX	08051A560JAT2A
3	CAP CRM 1.2nF 50V 10% X7R 0805 SMT	1	C96	AVX	08055C122KAT2A
4	CAP CRM 10nF 100V 5% X7R 0805 SMT	4	C35-C38	AVX	08051C103JAT2A
5	CAP CRM 22uF 10V 20% X5R 1206 SMT	8	C54-C58,C93-C95	AVX	1206ZD226MAT2A
6	CAP CRM 1nF/2000V 10%++X7R 1206 SMT	2	C29,C65	AVX	1206GC102KAT1A
7	CAP CRM 100nF 100V 10% X7R 1206 SMT	2	C3,C92	AVX	12061C104KAT2A
8	CAP CER 39PF 50V 5% COG 0402	1	C13	AVX	04025A390JAT2A
9	Capacitor, X7R, 4.7uF, 25V, 10% 1210	1	C52	Murata	GRM32DR71E475KA61L
10	CAP CER 2.2uF 100V 10% X7R 1210 SMT	1	C104	CAPAX	1210X225K101SNT
11	CAP COG 100pF 50V 5% 0603	1	C19	AVX	06035A101JAT2A
12	Capacitor, X7R, 3.3nF, 16V, 10% 0603	1	C138	Murata	GRM188R71H332KA01
13	CAP CRM 100nF 50v 10% X7R 0603	4	C11,C12,C15,C100	Meritek	MA0603XR104K500
14	Capacitor, X7R, 47nF, 50V, 10% 0603	1	C20	AVX	06035C473KAT2A
15	Capacitor,X7R, 1uF, 25V, 10% 0603	3	C18,C50,C53	Murata	GRM188R71E105KA12D
16	CAP CRM 10nF 50v 10% X7R 0603 SMT	1	C17	Murata	GRM188R71H103KA01
17	CAP ALUM 22UF 100V 20% 6.3X11 P=2.5, 2000H	1	C103	Nichicon	UFW2A220MED
18	CON RJ45 SINGLE 8 POS. SHILDED after vibration	2	CON1,CON2	Bel Stewart	SS71800-007F
19	CON DC POWER JACK RA 2.0X6.3 T/H	1	J2	Shogyo Int Corp.	MJ-179P
20	Terminal block 2 Pole interlocking 3.5mm pitch	1	J1	DECA	MB332-350M02
21	Diode, Dual Switching BAV99W SOT323	1	D56	Diodes Inc.	BAV99W-7-F
22	DIO BRIDGE 100V 1A SMT	2	D6,D7	Vishay	DF01S-E3/45
23	DIO SCHOTTKY 90V 1A SMA REC SMT	1	D10	Vishay	SS1H10-E3
24	DIO SCHOTTKY 30V 2A SOD323F SMT	1	D15	NXP	PMEG3020EJ
25	DIODE SCHOTTKY 70V 0.2A,225 W, SOD123	1	D55	ON Semiconductor	MMSD701T1G
26	DIO SCHOTTKY 40V 500mA SOD123 REC. SMT	2	D4,D8	ON Semiconductor	MBR0540T1G
27	IC Prog Shunt Ref 2.5V 2% SOT23-5 SMT	1	D14	Philips	TL431CD5
28	IC, N-CH POWER MOSFET 150v 4.1A SO8	1	Q3	Fairchild	FDS86242
29	1000 BASE ?T SINGLE PORT MAGNETICS SMT	1	J4	BOTHHAND	VP6014 HF
30	Power Inductors 2.2uHy 1.5A 110mOhm SMT Shilded	1	L3	Coilcraft	LPS3015-222MR
31	Power Inductor 0.33uH 20A Shilded SMT	1	L1	Bourns	SRP7030-R33M
32	Transformer, Gate driver SMT 269uH 0.795 DCR	1	T2	Coilcraft	DA2319-AL
33	Flyback Transformers 13W 127uH 5V 2.6A SMT	1	T3	Coilcraft	POE13P-50L
34	LED SuperYelGm 100-130o 20-40mcd h=1 0603 SMD	1	D5	Everlight	19-21-SYGCS530E3TR8
35	IC OPTOISOLATOR MOC217	1	U8	Fairchild	MOC217R2-M
36	RES TCK FLM 0R 125mW 5% 0805 SMT	2	R27,R35	Bourns	CR0805-J/-000-ELF
37	RES 75R 125mW 1% 0805 SMT	4	R38-R41	Bourns	CR0805-FX-75R0-ELF
38	RES 0R 250mW 5% 1206 SMT JUMPER<0.05R	2	R126,R128	Samsung	RC3216J000CS
39	RES 0.13R 0.5W 1% 1206 SMT	1	R44	Susumu Co.	RL1632R-R130-F
40	RES 5.11R 250mW 1% 1206 SMT	1	R129	Samsung	RC3216F5R11CS



PD70101EVBxF Evaluation Board – User Guide

41	RES 130R 250mW 1% 1206 SMT MTL FLM	1	R45	KOA	RK73H2BTDD1300F
42	RES TK FLM 20K 250mW 1% 1206	1	R71	Bourns	CR1206-FX-2002-ELF
43	RES TCK FLM 0R 62.5mW 5% 0603 SMT	1	R87	ASJ	CR16-000ZL
44	RES 17.8K 1% 1/16W 0603 SMT MTL FLM	1	R81	ASJ	CR16-1782FL
45	RES TCK FLM 24.9K 62.5mW 1% 0603 SMT	1	R3	ASJ	CR16-2492FL
46	RES 383K 100mW 1% 0603SMT MTL FLM	1	R31	ASJ	CR16-3833FL
47	Resistor, 68K, 5%, 1/16W 0603	1	R34	ASJ	CR16-683JL
48	RES TCK FLM 5.1K 62.5mW 1% 0603 SMT	1	R55	ASJ	CR16-5101FL
49	RES 562K, 1%, 1/16W, 0603	1	R64	ASJ	CR16-5623FL
50	RES 3.65K 0.1W 1% 0603 SMT MTL FLM	1	R76	ASJ	CR16-3651-FL
51	Resistor, 240K, 1%, 1/10W 0603	1	R2	KOA	RK73H1JTDD2403F
52	RES 4.75R 0.1W 1% 0603 SMT MTL FLM	4	R82-R84,R136	Samsung	RC1608F4R75CS
53	RES TCK FLM 0R 62.5mW 5% 0603 SMT	1	R1	ASJ	CR16-2000FL
54	RES 332R 62.5mW 1% 0603 SMT MTL FLM	1	R53	ASJ	CR16-3320FL
55	RES 511R 100mW 1% 0603 SMT MTL FLM 100 ppm	1	R77	Panasonic	ERJ3EKF5110V
56	RES 10K 62.5mW 1% 0603 SMT MTL FLM	2	R36,R73	ASJ	CR16-1002FL
57	RES 34K 62.5mW 1% 0603 SMT	1	R130	Samsung	RC1608F3402CS
58	RES 51.1K 62.5mW 1% 0603 SMT MTL FLM	2	R52,R54	ASJ	CR16-5112FL
59	RES 1M 62.5mW 1% 0603 SMT MTL FLM	1	R21	ASJ	CR16-1004-FL
60	TRN PNP -30V -1A SOT23	1	Q2	Fairchild	FMMT549
61	MOSFET N-CH 40V 12.8A 8-SOIC SMT	1	Q4	Fairchild	FDS8447
62	DIO TVS 58V 40A SRG 400WPK SMA SMT	1	D3	Diodes Inc.	SMAJ58A



PD70101EVBx F Evaluation Board – User Guide

Table 10: PD70101EVB15F12 Assembly

Item	Description	Qty	Ref Des	Manufacturer	Manufacturer PN
1	AF POE PD controller for IEEE 802.3 PD70101	1	U13	Microsemi	PD70101ILQ-TR.
2	CAP CRM 56pF 100V 5% NPO 0805 SMT	1	C133	AVX	08051A560JAT2A
3	CAP CRM 680pF 100V 5% NPO 0805 SMT	1	C96	Hitano	0805N681J101NT
4	CAP CRM 10nF 100V 5% X7R 0805 SMT	4	C35-C38	AVX	08051C103JAT2A
5	Capacitor, X5R, 10uF, 25V, 10% 1206	8	C54-C58,C93-C95	Murata	GRM31CR61E106KA12L
6	CAP CRM 1nF/2000V 10%++X7R 1206 SMT	2	C29,C65	AVX	1206GC102KAT1A
7	CAP CRM 100nF 100V 10% X7R 1206 SMT	2	C3,C92	AVX	12061C104KAT2A
8	CAP CER 39PF 50V 5% C0G 0402	1	C13	AVX	04025A390JAT2A
9	Capacitor, X7R, 4.7uF, 25V, 10% 1210	1	C52	Murata	GRM32DR71E475KA61L
10	CAP CER 2.2uF 100V 10% X7R 1210 SMT	1	C104	CAPAX	1210X225K101SNT
11	CAP COG 100pF 50V 5% 0603	1	C19	AVX	06035A101JAT2A
12	Capacitor, X7R, 3.3nF, 16V, 10% 0603	1	C138	Murata	GRM188R71H332KA01
13	CAP CRM 100nF 50v 10% X7R 0603	4	C11,C12,C15,C100	Meritek	MA0603XR104K500
14	Capacitor, X7R, 47nF, 50V, 10% 0603	1	C20	AVX	06035C473KAT2A
15	Capacitor,X7R, 1uF, 25V, 10% 0603	3	C18,C50,C53	Murata	GRM188R71E105KA12D
16	CAP CRM 10nF 50v 10% X7R 0603 SMT	1	C17	Murata	GRM188R71H103KA01
17	CAP ALUM 22UF 100V 20% 6.3X11 P=2.5	1	C103	Nichicon	UFW2A220MED
18	CON RJ45 SINGLE 8 POS. SHILDED	2	CON1,CON2	Bel Stewart	SS71800-007F
19	CON DC POWER JACK RA 2.0X6.3 T/H	1	J2	Shogyo Int Corp.	MJ-179P
20	Terminal block 2 Pole interlocking 3.5mm pitch	1	J1	DECA	MB332-350M02
21	Diode, Dual Switching BAV99W SOT323	1	D56	Diodes Inc.	BAV99W-7-F
22	DIO BRIDGE 100V 1A SMT	2	D6,D7	Vishay	DF01S-E3/45
23	DIO SCHOTTKY 90V 1A SMA REC SMT	1	D10	Vishay	SS1H10-E3
24	DIO SCHOTTKY 30V 2A SOD323F SMT	1	D15	NXP	PMEG3020EJ
25	DIODE SCHOTTKY 70V 0.2A,225 W, SOD123	1	D55	ON Semiconductor	MMSD701T1G
26	DIO SCHOTTKY 40V 500mA SOD123 REC. SMT	2	D4,D8	ON Semiconductor	MBR0540T1G
27	IC Prog Shunt Ref 2.5V 2% SOT23-5 SMT	1	D14	Philips	TL431CD5
28	IC, N-CH POWER MOSFET 150v 4.1A SO8	1	Q3	Fairchild	FDS86242
29	1000 BASET SINGLE PORT MAGNETICS SMT	1	J4	BOTHHAND	VP6014 HF
30	Power Inductors 2.2uHy 1.5A 110mOhm SMT Shilded	1	L3	Coilcraft	LPS3015-222MR
31	INDUCTOR SHIELDED PWR 1UH IRMS=11A SMT	1	L1	Bourns	SRP7030-1R0M
32	Transformer, Gate driver SMT 269uH 0.795 DCR	1	T2	Coilcraft	DA2319-AL
33	Flyback Transformers 13W 127uH 12V 1.08A SMT	1	T3	Coilcraft	POE13P-12L



PD70101EVBxF Evaluation Board – User Guide

34	LED SuperYelGm 100-130o 20-40mcd h=1 0603 SMD	1	D5	Everlight	19-21-SYGCS530E3TR8
35	IC OPTOISOLATOR MOC217	1	U8	Fairchild	MOC217R2-M
36	PCB Mrk Cisco 5V/6W/90perc Flyback EVB	1	PCB	IQE	PR-1419-F00-IQ
37	RES TCK FLM 0R 125mW 5% 0805 SMT	2	R27,R35	Bourns	CR0805-J/-000-ELF
38	RES 75R 125mW 1% 0805 SMT	4	R38-R41	Bourns	CR0805-FX-75R0-ELF
39	RES 0R 250mW 5% 1206 SMT JUMPER<0.05R	2	R126,R128	Samsung	RC3216J000CS
40	RES 0.13R 0.5W 1% 1206 SMT	1	R44	Susumu Co.	RL1632R-R130-F
41	RES 5.11R 250mW 1% 1206 SMT	1	R129	Samsung	RC3216F5R11CS
42	RES 130R 250mW 1% 1206 SMT MTL FLM	1	R45	KOA	RK73H2BTDD1300F
43	RES TK FLM 20K 250mW 1% 1206	1	R71	Bourns	CR1206-FX-2002-ELF
44	RES TCK FLM 0R 62.5mW 5% 0603 SMT	1	R87	ASJ	CR16-000ZL
45	RES 17.8K 1% 1/16W 0603 SMT MTL FLM	1	R81	ASJ	CR16-1782FL
46	RES TCK FLM 24.9K 62.5mW 1% 0603 SMT	1	R3	ASJ	CR16-2492FL
47	RES TCK FLM 14.7K 62.5mW 1% 0603 SMT	1	R54	ASJ	CR16-1472FL
48	RES 383K 100mW 1% 0603SMT MTL FLM	1	R31	ASJ	CR16-3833FL
49	Resistor, 3.32K, 1%, 1/16W 0603	1	R77	ASJ	CR16-3321FL
50	Resistor, 68K, 5%, 1/16W 0603	1	R34	ASJ	CR16-683JL
51	RES TCK FLM 5.1K 62.5mW 1% 0603 SMT	1	R55	ASJ	CR16-5101FL
52	RES 562K, 1%, 1/16W, 0603	1	R64	ASJ	CR16-5623FL
53	RES 3.65K 0.1W 1% 0603 SMT MTL FLM	1	R76	ASJ	CR16-3651-FL
54	Resistor, 240K, 1%, 1/10W 0603	1	R2	KOA	RK73H1JTDD2403F
55	Resistor, SMT 56K, 1%, 1/10W 0603	1	R52	KOA	RK73H1JTDD5602F
56	RES 4.75R 0.1W 1% 0603 SMT MTL FLM	4	R82-R84,R136	Samsung	RC1608F4R75CS
57	RES TCK FLM 0R 62.5mW 5% 0603 SMT	1	R1	ASJ	CR16-1000FL
58	RES 332R 62.5mW 1% 0603 SMT MTL FLM	1	R53	ASJ	CR16-3320FL
59	RES 10K 62.5mW 1% 0603 SMT MTL FLM	2	R36,R73	ASJ	CR16-1002FL
60	RES 34K 62.5mW 1% 0603 SMT	1	R130	Samsung	RC1608F3402CS
61	RES 1M 62.5mW 1% 0603 SMT MTL FLM	1	R21	ASJ	CR16-1004-FL
62	TRN PNP -30V -1A SOT23	1	Q2	Fairchild	FMMT549
63	IC N-CH POWER MOSFET 80V 6.5A SOIC8	1	Q4	Fairchild	FDS3590
64	DIO TVS 58V 40A SRG 400WPK SMA SMT	1	D3	Diodes Inc.	SMAJ58A

Board Layout

This paragraph presents the layout of the evaluation board.

The board is a 2 layer board. The layers are 2 Oz layers. Below figures present the two copper layers and the silk of the board for tracking devices placements.

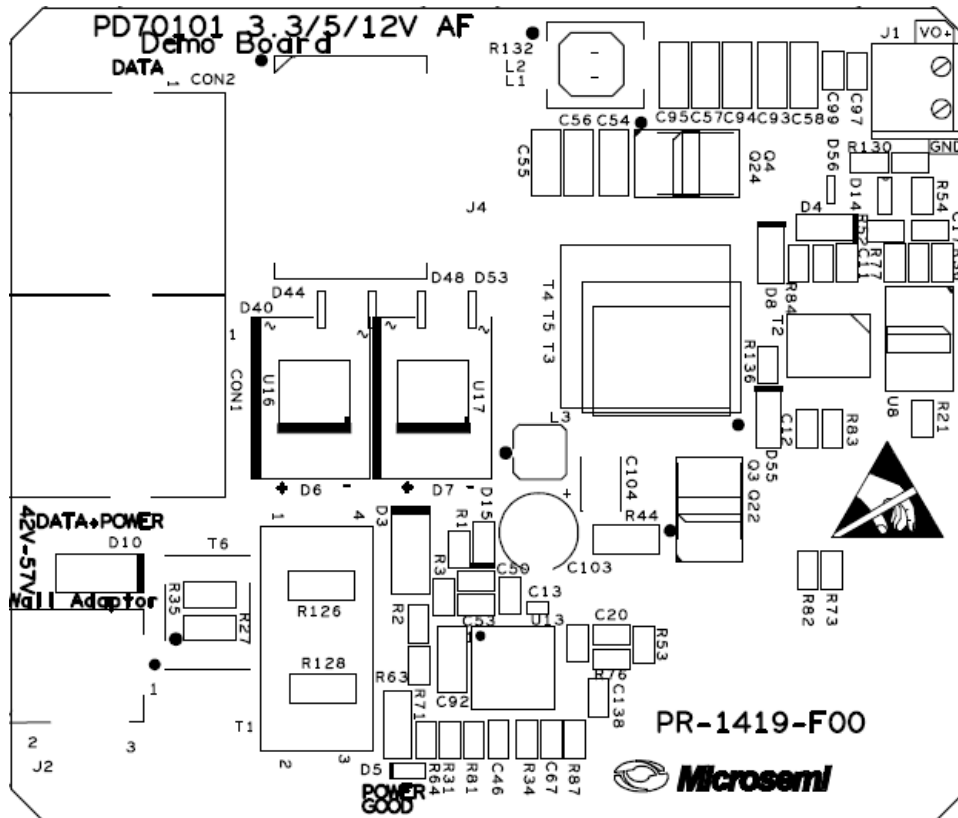

Figure 26: Top Silk

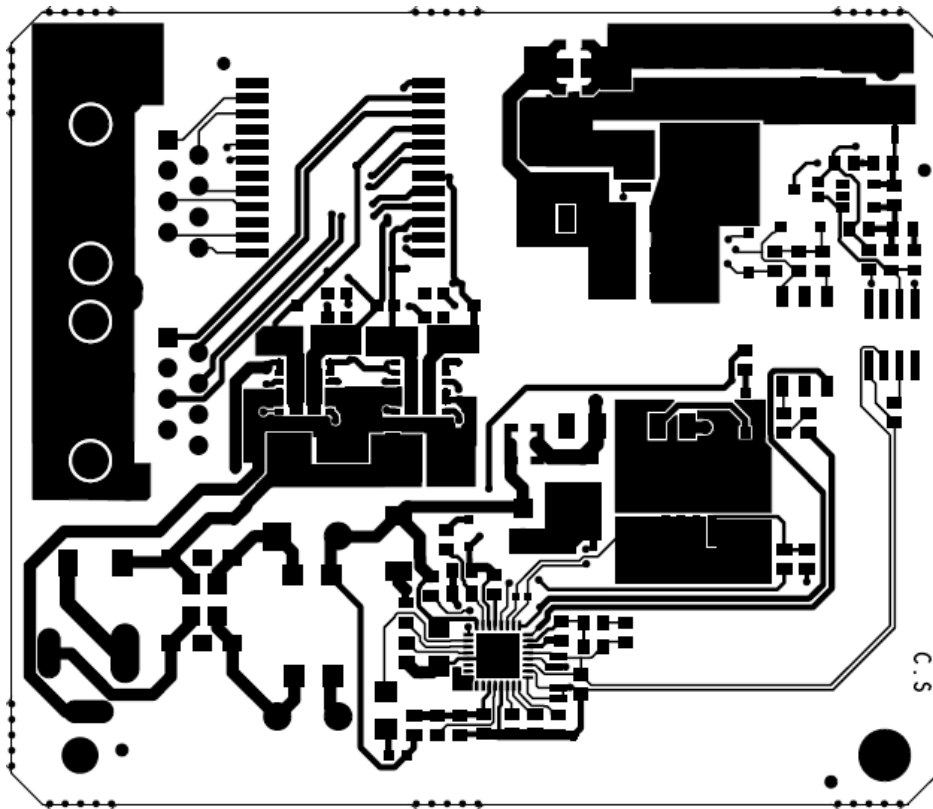

Figure 27: Top Layer

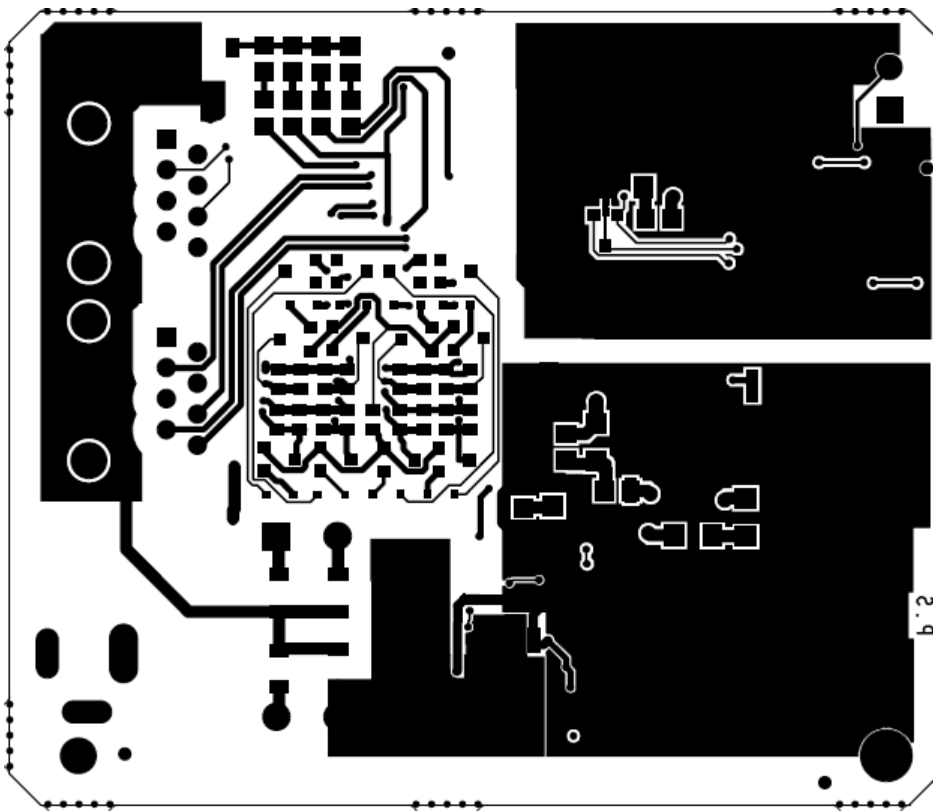

Figure 28: Bottom Layer

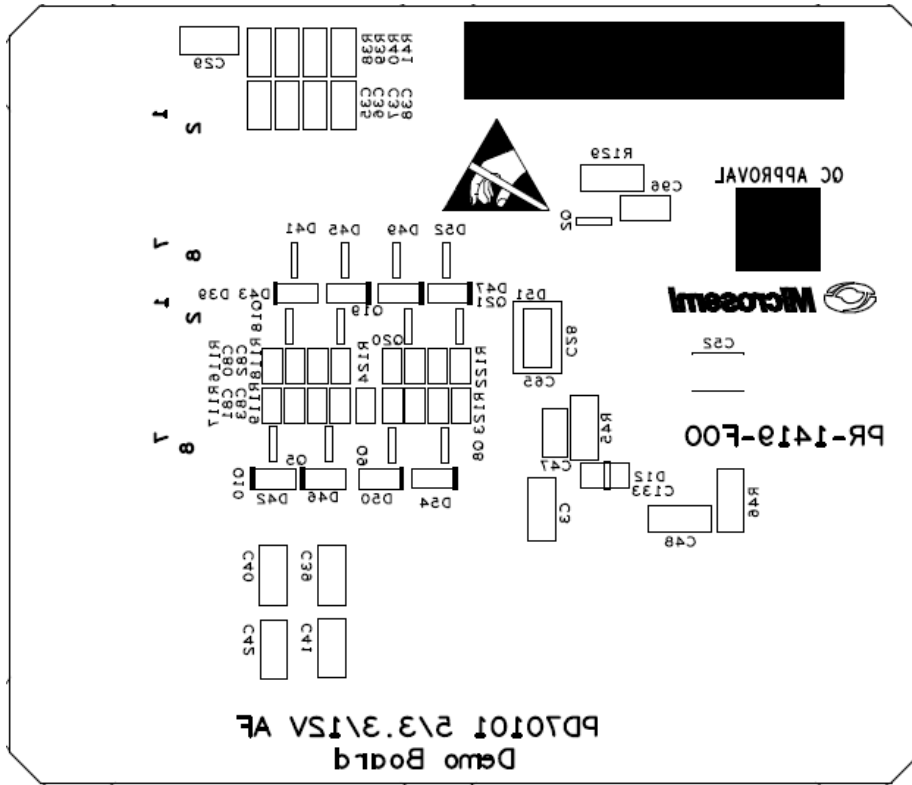

Figure 29: Bottom Silk