

### PE4151

#### UltraCMOS® Low Frequency Passive Mixer with Integrated LO Amplifier

#### Product Description

The PE4151 is an ultra-high linearity Quad MOSFET mixer with an integrated LO amplifier. The LO amplifier allows for LO drive levels of less than 0 dBm to produce IIP3 values similar to a Quad MOSFET Array driven with a 15 dBm LO drive. It is designed for use in up-conversion and down-conversion applications such as mobile radios, cellular infrastructure equipment, and STB/CATV systems.

The PE4151 operates with differential signals at the RF and IF ports while the LO port can be either differential or single-ended.

The PE4151 is an ideal mixer core for a wide range of mixer products, including module level solutions that incorporate baluns or other single-ended matching structures enabling three-port operation.

The PE4151 is manufactured on pSemi's UltraCMOS® process, a patented variation of silicon-on-insulator (SOI) technology on a sapphire substrate, offering the performance of GaAs with the economy and integration of conventional CMOS. This process enables the PE4151 to have a high

#### Features

- Ultra-high linearity Quad MOSFET array with integrated LO amplifier
- Ideal for mobile radio and up or down conversion applications
- Low conversion loss
- High LO Isolation
- RoHS compliant 10-lead MSOP package
- Ideal for highly magnetic environments

**Figure 1. Functional Diagram**

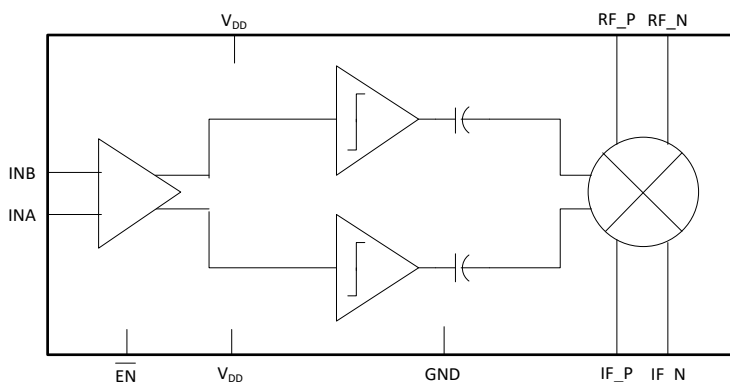

**Figure 2. Package Type**  
10-Lead MSOP  
3 × 3 × 0.86 mm

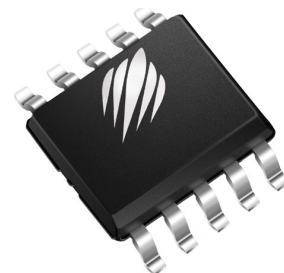

**Table 1. AC and DC Electrical Specifications<sup>1</sup>** ( $V_{DD} = 3.0V$ , temperature = +25 °C unless specified otherwise)

Parameters	Min	Typ	Max	Unit
Current drain (a function of frequency)		5	8	mA
Off state leakage current			20	$\mu A$
RF input frequency				
VHF band	136		174	MHz
UHF1 band	380		470	MHz
UHF2 band	450		520	MHz
LO frequency				
VHF band	245.65		283.65	MHz
UHF1 band	270.35		360.35	MHz
UHF2 band	340.35		410.35	MHz
IF output frequency	44.85		109.65	MHz
LO input power	-10	-8	-6	dBm
RF input power			2	dBm
Conversion loss				
VHF band		6.5	8	dB
UHF1 band		7	8.5	dB
UHF2 band		7	8.5	dB
3 <sup>rd</sup> order input intercept (IIP3) <sup>2</sup>	20	26		dBm
2 <sup>nd</sup> order input intercept (IIP2) <sup>2</sup>				
VHF band	40	55		dBm
UHF1 band	35	45		dBm
UHF2 band	35	45		dBm
RF to IF isolation	35	50		dB
LO to IF isolation	25	40		dB
LO to RF isolation	25	43		dB

Notes: 1. Measurements taken on PE4151 evaluation board with M/A-Com ETK4-2T baluns on the RF and IF ports. See Figure 45 for details.  
2. IIP2 and IIP3 are measured with two tones at 0 dBm, 100 kHz spacing.

**Table 2. Supplemental Table for Operation in HF Band\*** ( $V_{DD} = 3.0V$ , temperature = +25 °C unless specified otherwise)

Parameters	Min	Typ	Max	Unit
RF input frequency		32.5		MHz
LO frequency		40		MHz
IF output frequency		7.5		MHz
LO input power	-10	-8	-6	dBm
RF input power			2	dBm
Conversion loss		5	6.5	dB
3 <sup>rd</sup> order input intercept (IIP3)	20	25		dBm
2 <sup>nd</sup> order input intercept (IIP2)	55	65		dBm
RF to IF isolation	35	50		dB
LO to IF isolation	25	40		dB
LO to RF isolation	25	40		dB

Note: \* Measurements taken on PE4151 evaluation board with M/A-Com ETK4-2T baluns on the RF and IF ports. See Figure 45 for details.

Figure 3. Pin Configuration (Top View)

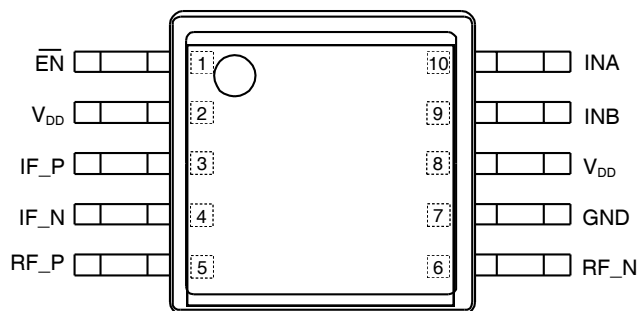

Table 3. Pin Descriptions

Pin #	Symbol	Function
1	$\overline{\text{EN}}$	Enable pin (active low)
2	$V_{\text{DD}}$	Supply voltage
3	IF_P	Positive IF port
4	IF_N	Negative IF port
5	RF_P	Positive RF input
6	RF_N	Negative RF input
7	GND	Ground
8	$V_{\text{DD}}$	Supply voltage
9	INB	Positive LO input
10	INA	Negative LO input

Table 4. Operating Ranges

Parameters/Conditions	Min	Typ	Max	Unit
$V_{\text{DD}}$ Power supply voltage	2.9	3.0	3.1	V
$T_{\text{OP}}$ Operating temperature range	-40		+85	°C

Note: Operation should be restricted to the limits in the Operating Ranges table.

Table 5. Absolute Maximum Ratings

Parameters/Conditions	Min	Max	Unit
$V_{\text{DS}}$ Maximum DC plus peak AC across drain-source		$\pm 3.3$	V
$I_{\text{DS-DC}}$ Maximum DC current across drain-source		6	mA
$T_{\text{ST}}$ Storage temperature range	-65	+150	°C
$T_{\text{j}}$ Operating junction temperature		+125	°C
$V_{\text{ESD}}$ ESD voltage HBM, MIL_STD 883 Method 3015.7		1000	V

Exceeding absolute maximum ratings may cause permanent damage. Operation should be restricted to the limits in the Operating Ranges table. Operation between operating range maximum and absolute maximum for extended periods may

### Electrostatic Discharge (ESD) Precautions

When handling this UltraCMOS device, observe the same precautions that you would use with other ESD-sensitive devices. Although this device contains circuitry to protect it from damage due to ESD, precautions should be taken to avoid exceeding the specified rating.

### Latch-Up Avoidance

Unlike conventional CMOS devices, UltraCMOS devices are immune to latch-up.

Table 6. Power On/Off Control

Function	$\overline{\text{EN}}$
Powered On Mode	0
Power Off Mode	1

### Moisture Sensitivity Level

The moisture sensitivity level rating for the PE4151 in the 10-lead MSOP package is MSL1.

Figure 4. Conversion Loss vs Voltage

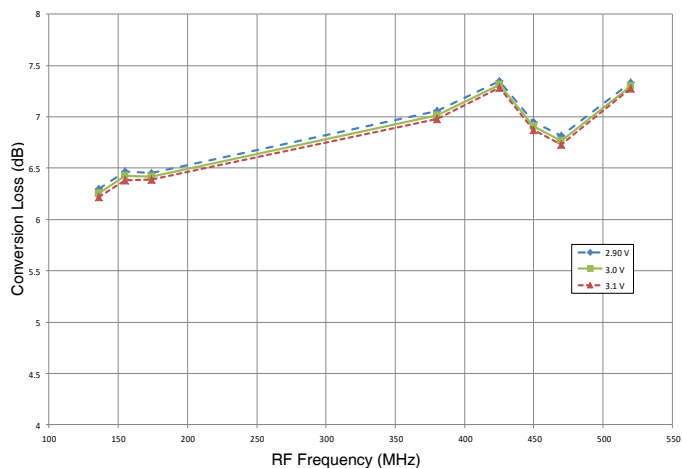

Figure 5. Conversion Loss vs Temperature (3.0V, -6 dBm LO Input, 109.65 MHz IF)

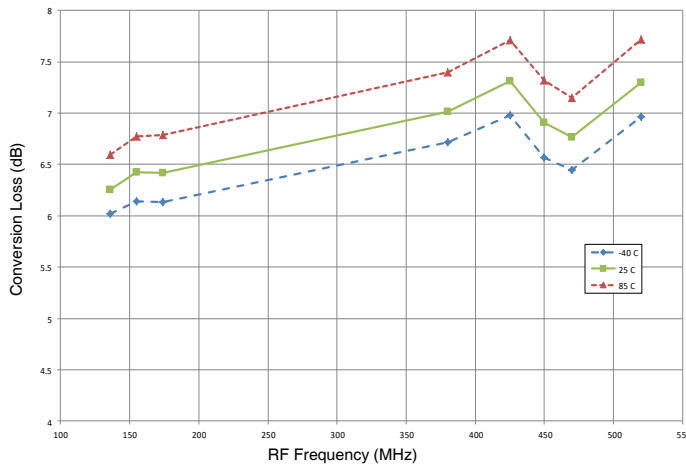

Figure 6. RF to IF Isolation vs Voltage (25 °C, -6 dBm LO Input, 109.65 MHz IF)

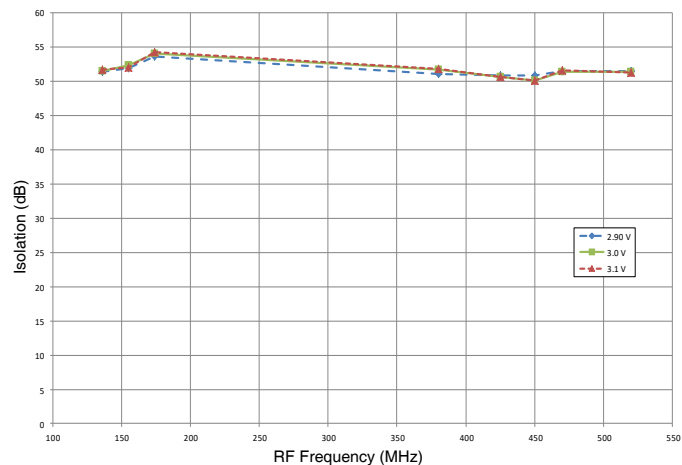

Figure 7. RF to IF Isolation vs Temperature (3.0V, -6 dBm LO Input, 109.65 MHz IF)

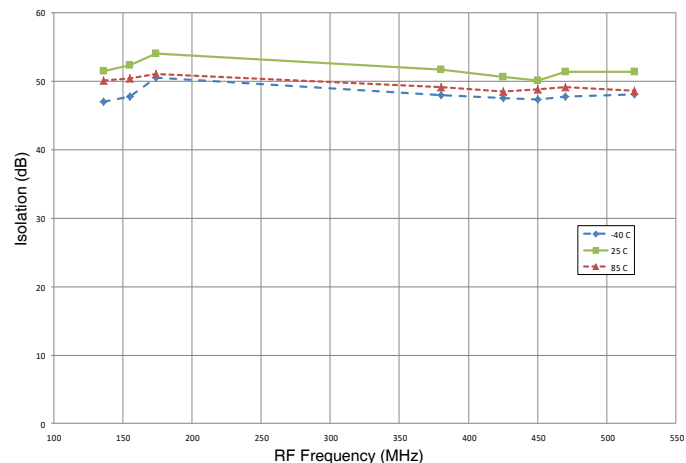

Figure 8. LO to IF Isolation vs Voltage (25 °C, -6 dBm LO Input, 109.65 MHz IF)

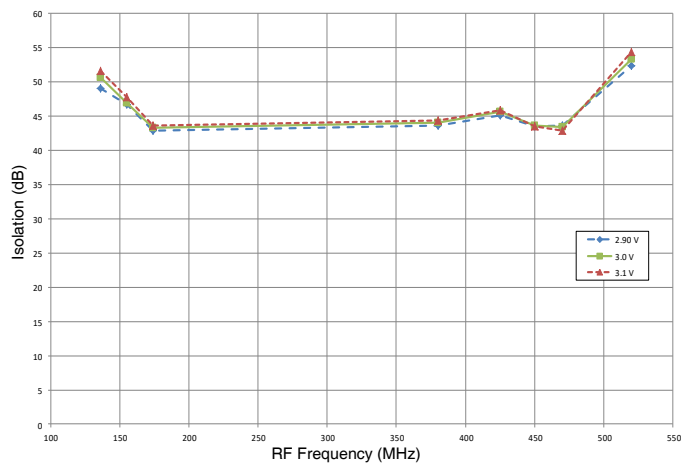
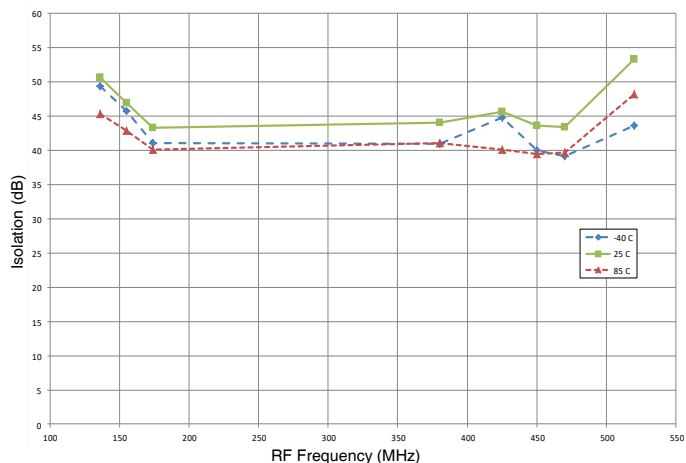
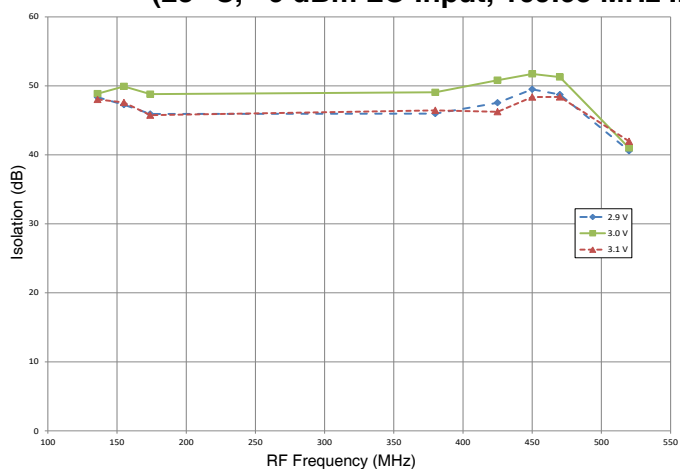

Figure 9. LO to IF Isolation vs Temperature (3.0V, -6 dBm LO Input, 109.65 MHz IF)



**Figure 10. LO to RF Isolation vs Voltage**  
(25 °C, -6 dBm LO Input, 109.65 MHz IF)



**Figure 11. LO to RF Isolation vs Temperature**  
(3.0V, -6 dBm LO Input, 109.65 MHz IF)

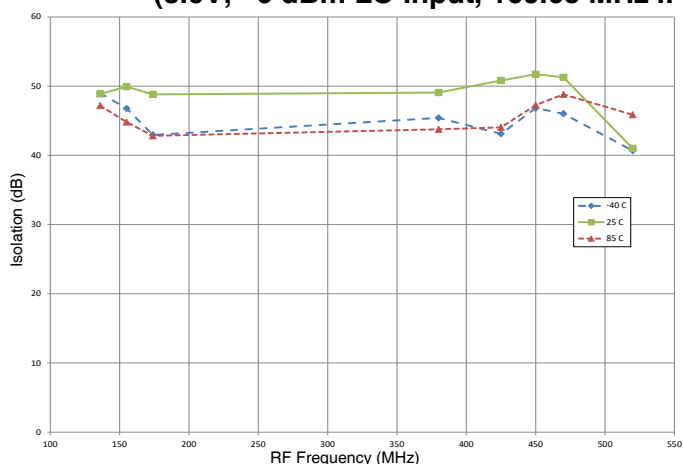

**Figure 12. IIP3 vs Voltage**  
(25 °C, -6dBm LO Input, 109.65 MHz IF)

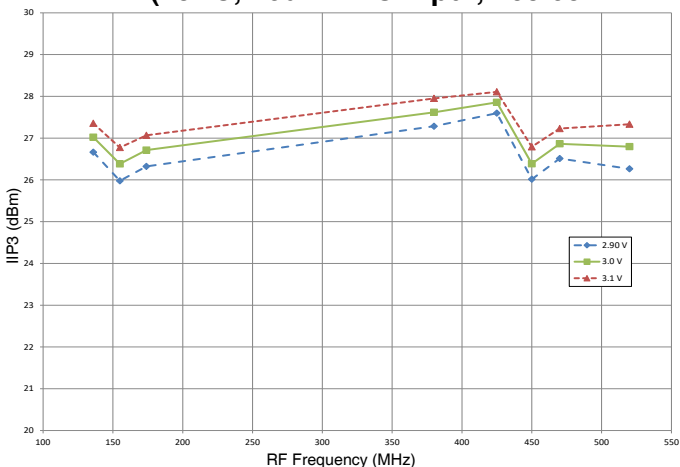

**Figure 13. IIP3 vs Temperature**

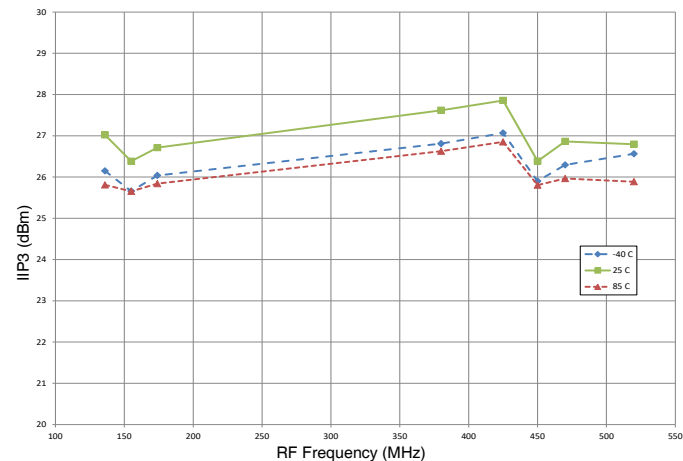

**Figure 14. IIP2 vs Voltage**  
(25 °C, -6 dBm LO Input, 109.65 MHz IF)

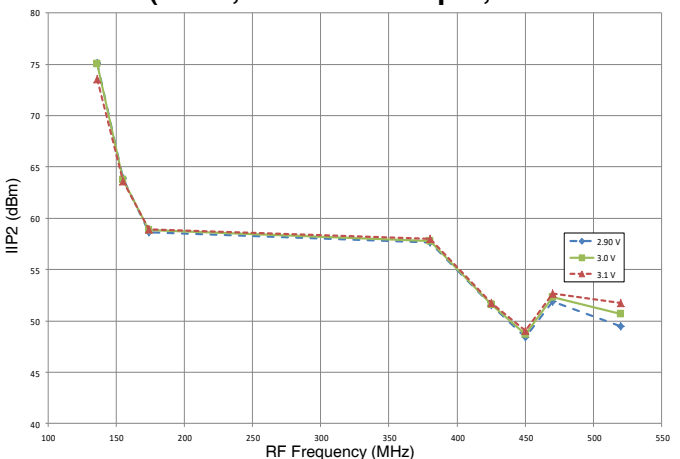

**Figure 15. IIP2 vs Temperature**  
(3.0V, -6 dBm LO Input, 109.65 MHz IF)

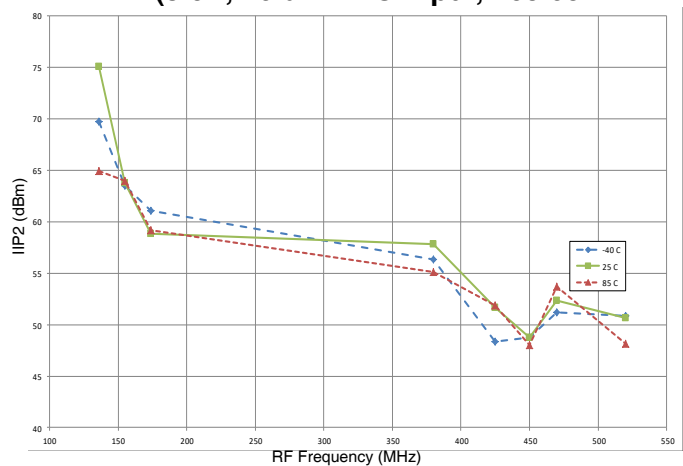

**Figure 16. IIP2 vs LO Input Power**  
(3.0V, 25 °C, 109.65 MHz IF)

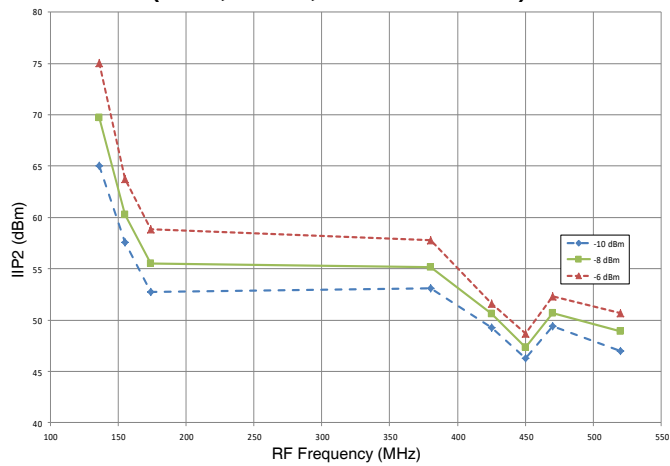

**Figure 17. IIP3 vs LO Input Power**  
(3.0V, 25 °C, 109.65 MHz IF)

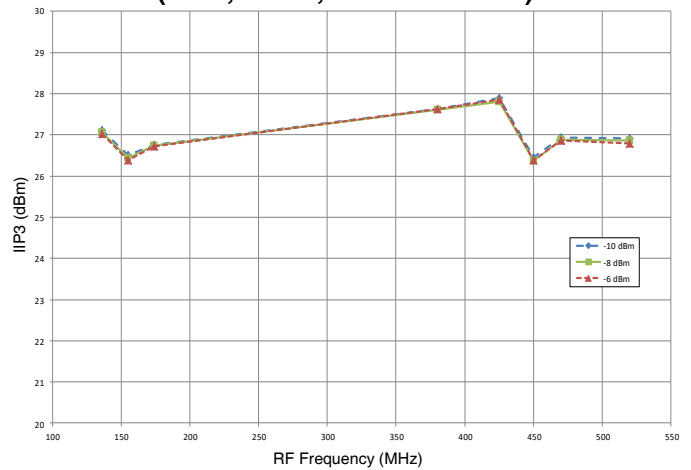

Figure 18. Conversion Loss vs  $V_{DD}$

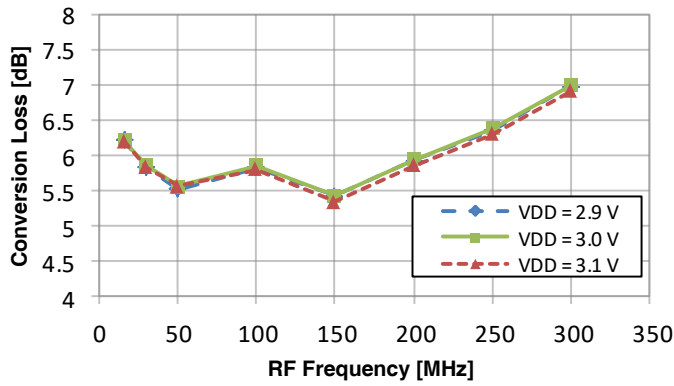

Figure 19. RF to IF Isolation vs  $V_{DD}$

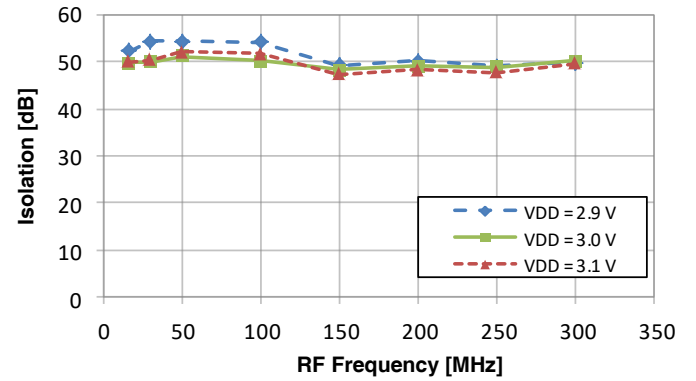

Figure 20. LO to IF Isolation vs  $V_{DD}$

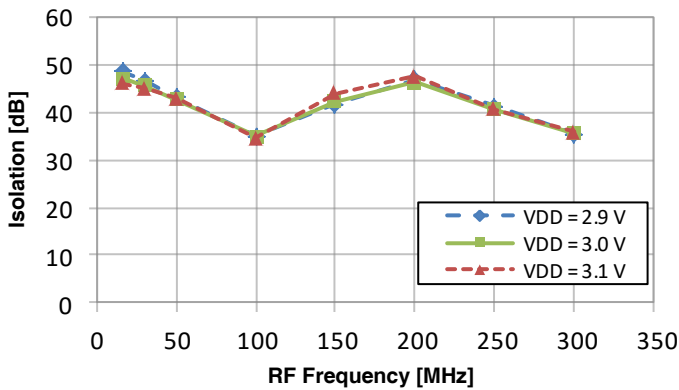

Figure 21. LO to RF Isolation vs  $V_{DD}$

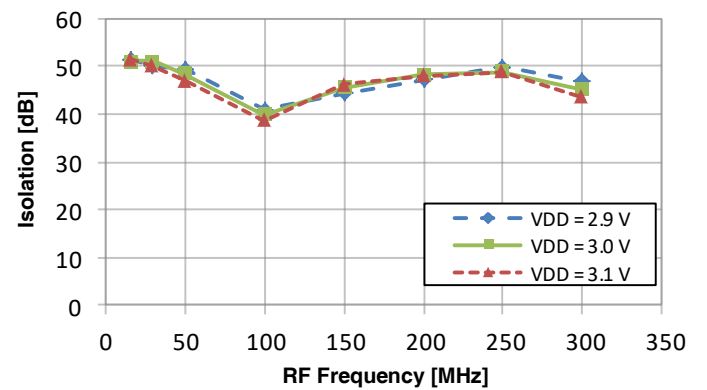

Figure 22. IIP2 vs  $V_{DD}$

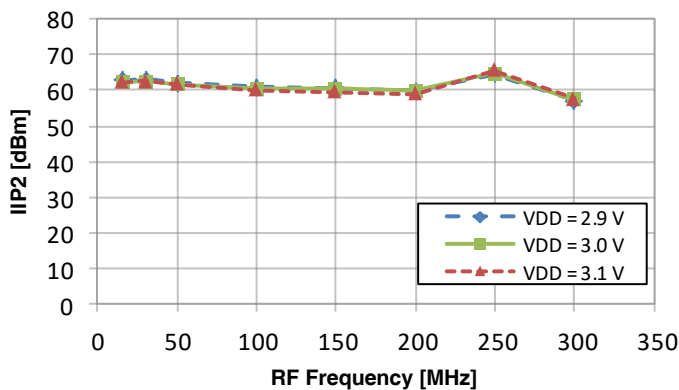

Figure 23. IIP3 vs  $V_{DD}$

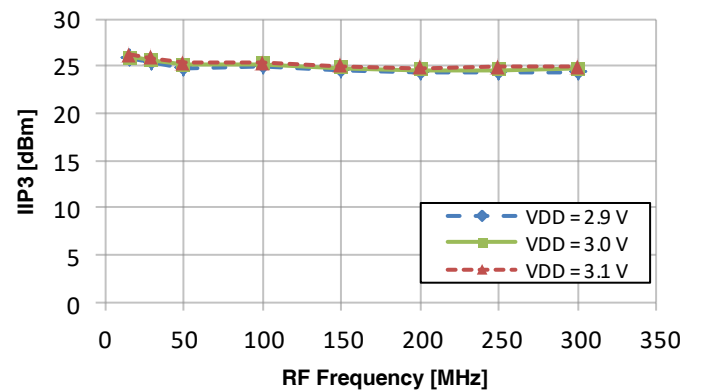

Figure 24. Conversion Loss vs  $V_{DD}$

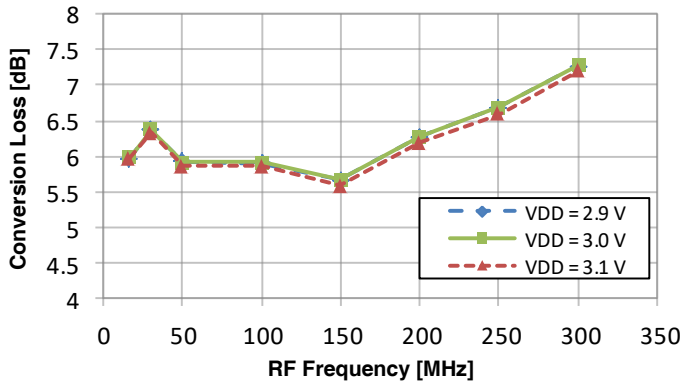

Figure 25. RF to IF Isolation vs  $V_{DD}$

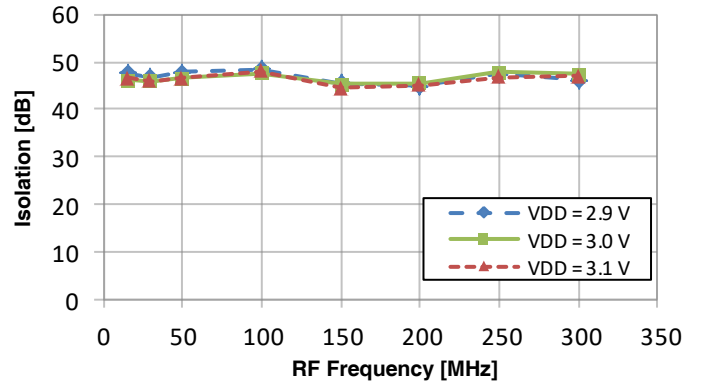

Figure 26. LO to IF Isolation vs  $V_{DD}$

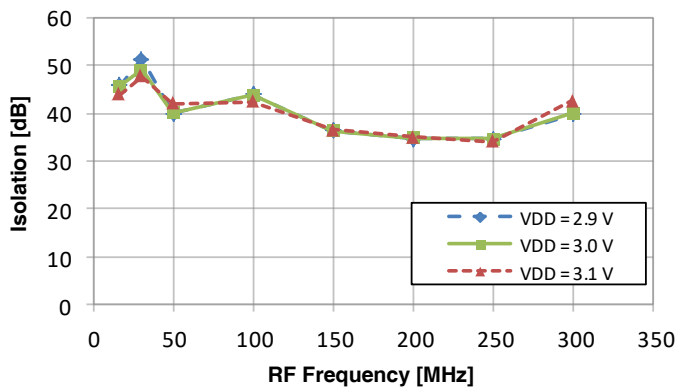

Figure 27. LO to RF Isolation vs  $V_{DD}$

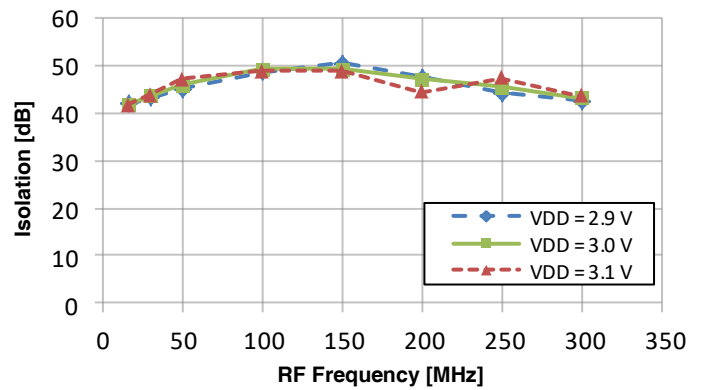

Figure 28. IIP2 vs  $V_{DD}$

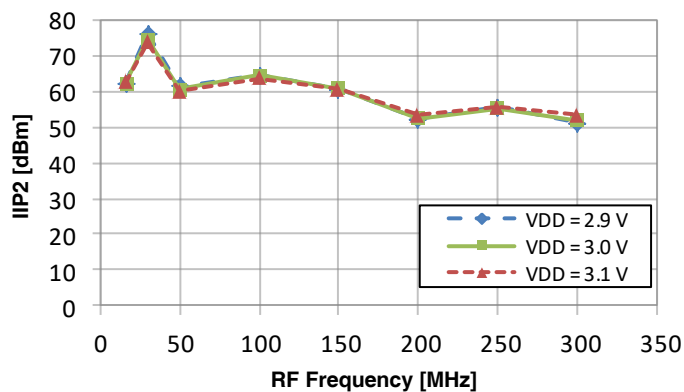

Figure 29. IIP3 vs  $V_{DD}$

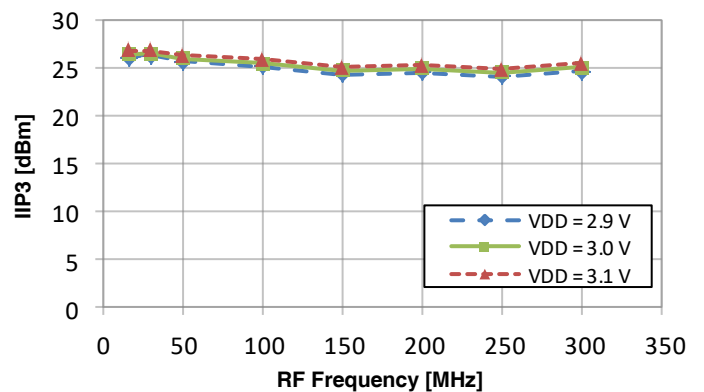



Figure 30. Conversion Loss vs  $V_{DD}$

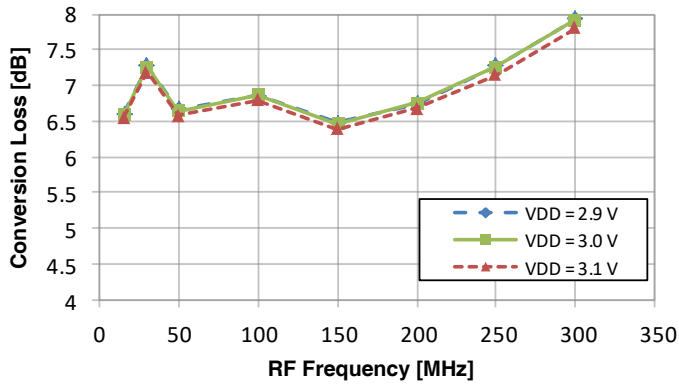

Figure 31. RF to IF Isolation vs  $V_{DD}$

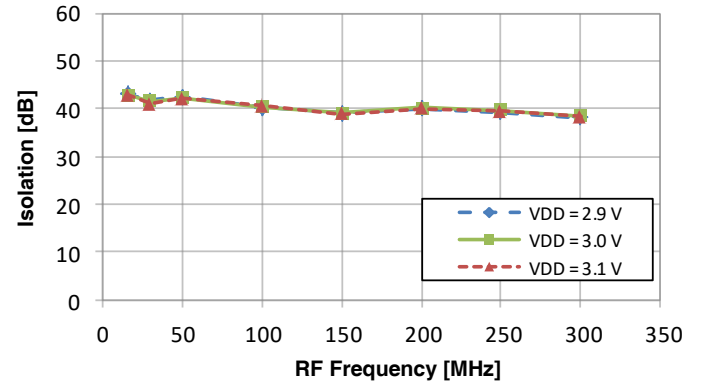

Figure 32. LO to IF Isolation vs  $V_{DD}$

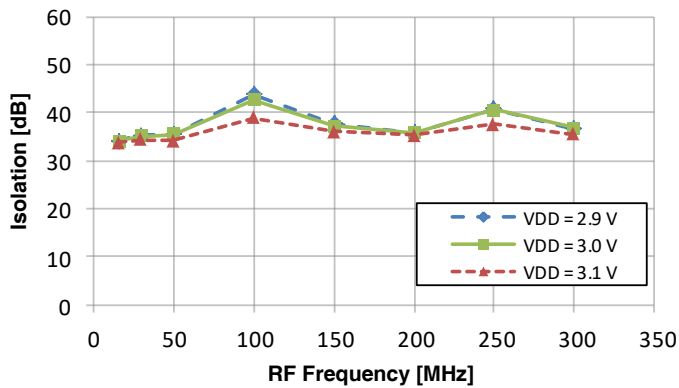

Figure 33. LO to RF Isolation vs  $V_{DD}$

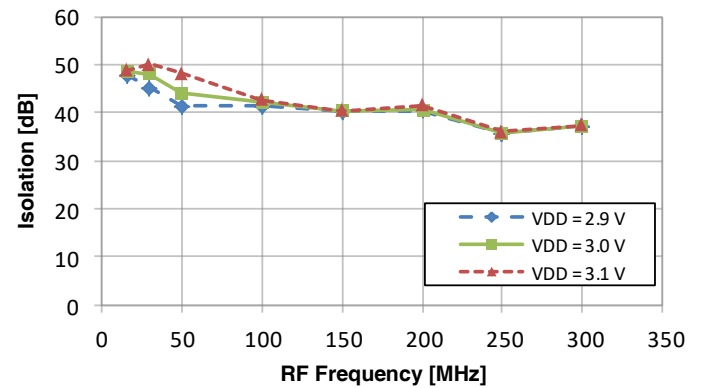

Figure 34. IIP2 vs  $V_{DD}$

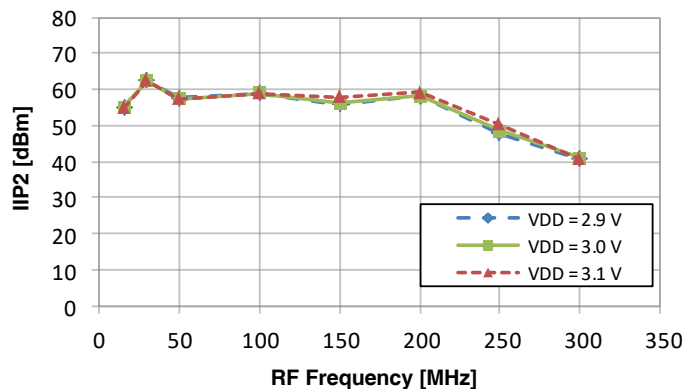

Figure 35. IIP3 vs  $V_{DD}$

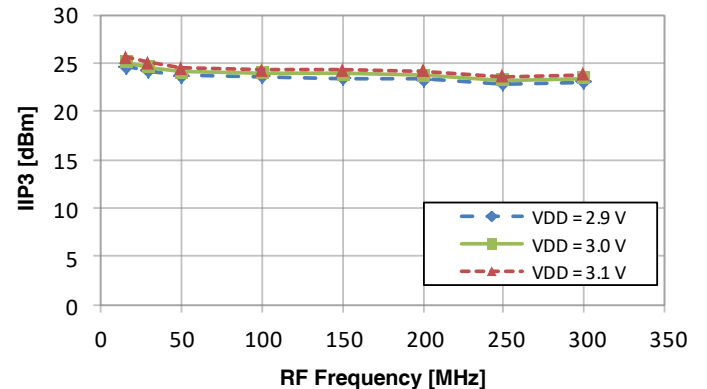

Figure 36. Conversion Loss vs IF Frequency (25 °C, -8 dBm LO Input)

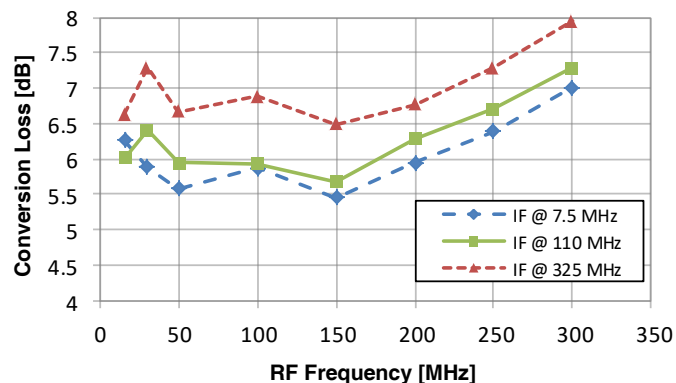

Figure 37. RF to IF Isolation vs IF Frequency (25 °C, -8 dBm LO Input)

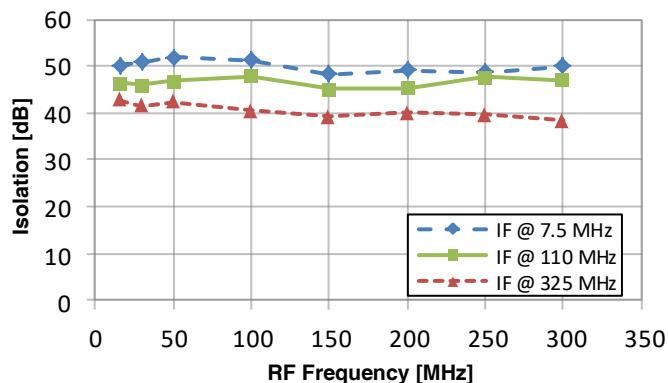

Figure 38. LO to IF Isolation vs IF Frequency (25 °C, -8 dBm LO Input)

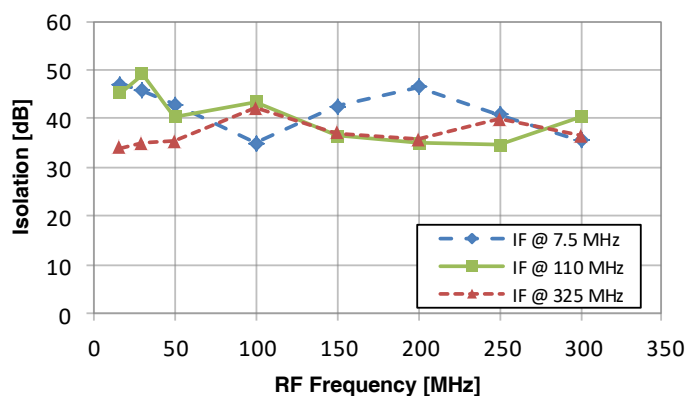

Figure 39. LO to RF Isolation vs IF Frequency (25 °C, -8 dBm LO Input)

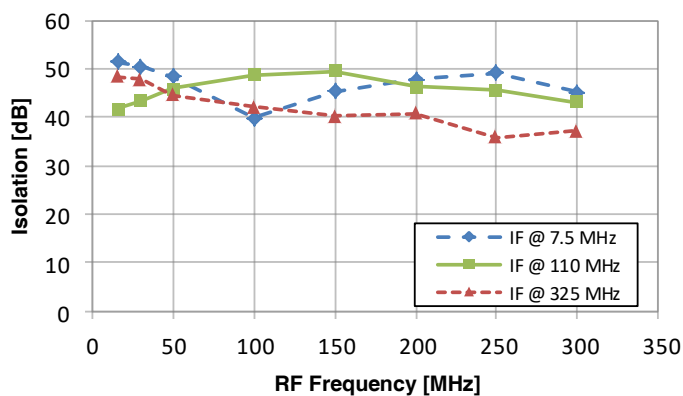

Figure 40. IIP2 vs IF Frequency (25 °C, -8 dBm LO Input)

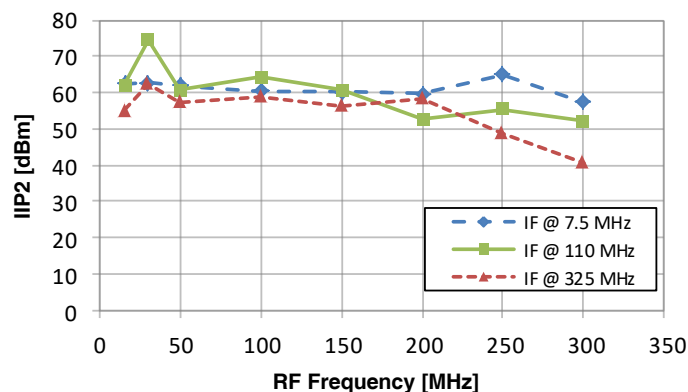
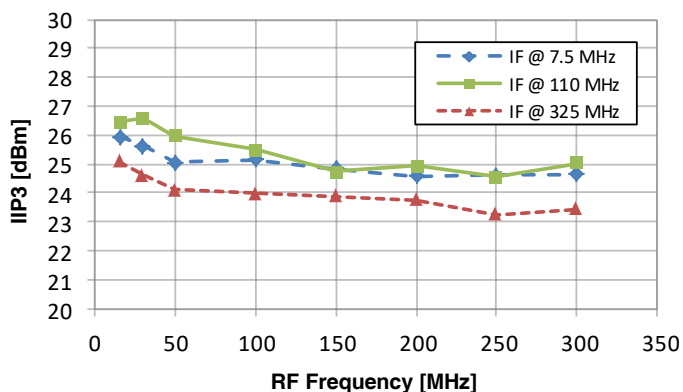
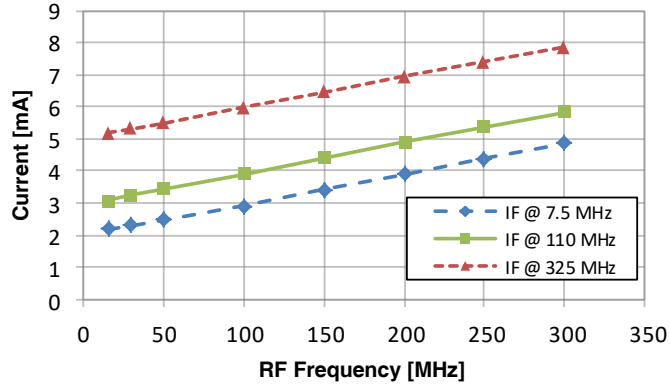

Figure 41. IIP3 vs IF Frequency (25 °C, -8 dBm LO Input)



**Figure 42.  $I_{DD}$  vs IF Frequency**  
(25 °C, -8 dBm LO Input)



**Figure 43. P1dB vs IF Frequency**  
(25 °C, -8 dBm LO Input)

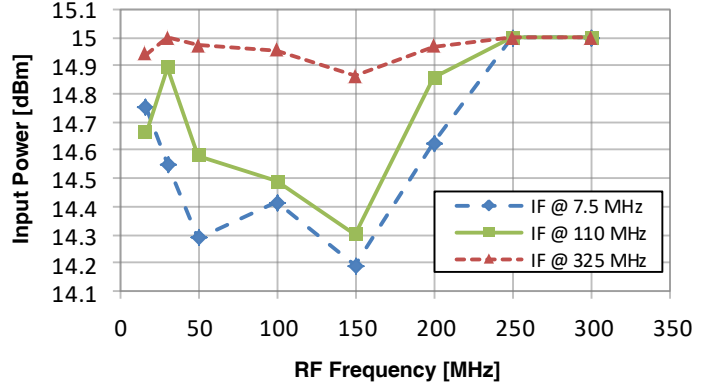

## Evaluation Kit

The mixer evaluation kit board was designed to ease customer evaluation of the PE4151 quad MOSFET mixer with integrated LO amplifier.

The RF and IF ports are connected through 50Ω transmission lines and 1:4 transmission line transformers to J5 and J7, respectively. The LO ports are connected through 50Ω transmission lines to J1 and J3, respectively, and can support either a single-ended or differential signal drive. With a single-ended input, no termination is needed on the un-used port.

The board is constructed of a two metal layer FR4 with a total thickness of 0.062". The bottom layer provides ground for the RF transmission lines. The transmission lines were designed using a coplanar waveguide with ground plane model using a trace width of 0.037", trace gaps of 0.008", dielectric thickness of 0.059" and metal thickness of 0.0015".

J6 can be used to enable or disable the part. The chip enable  $\overline{EN}$  is active low.

De-coupling capacitors are provided on the  $V_{DD}$  traces. These capacitors should be placed as close to the  $V_{DD}$  pin as possible.

**Figure 44. Evaluation Board Layout**

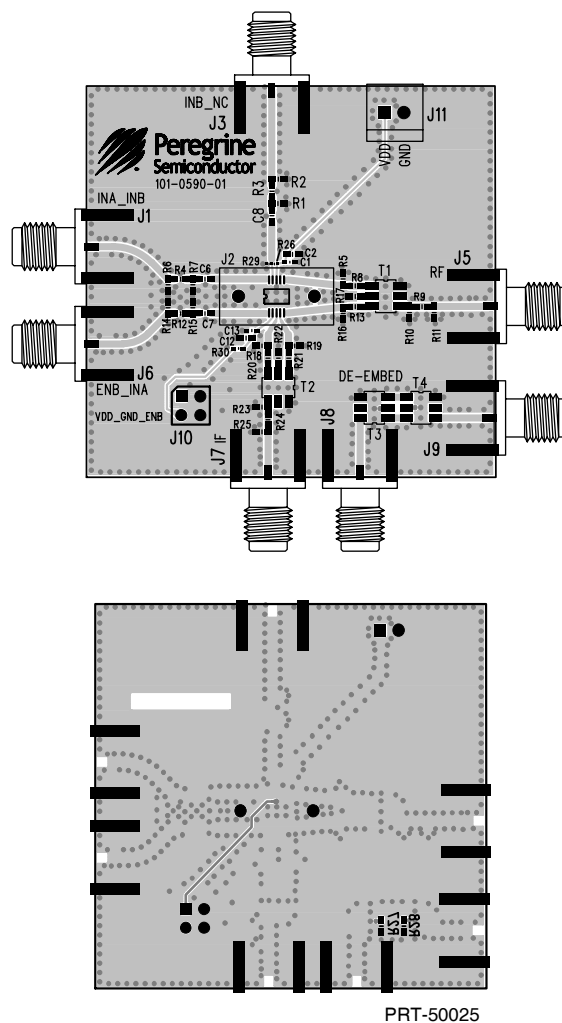
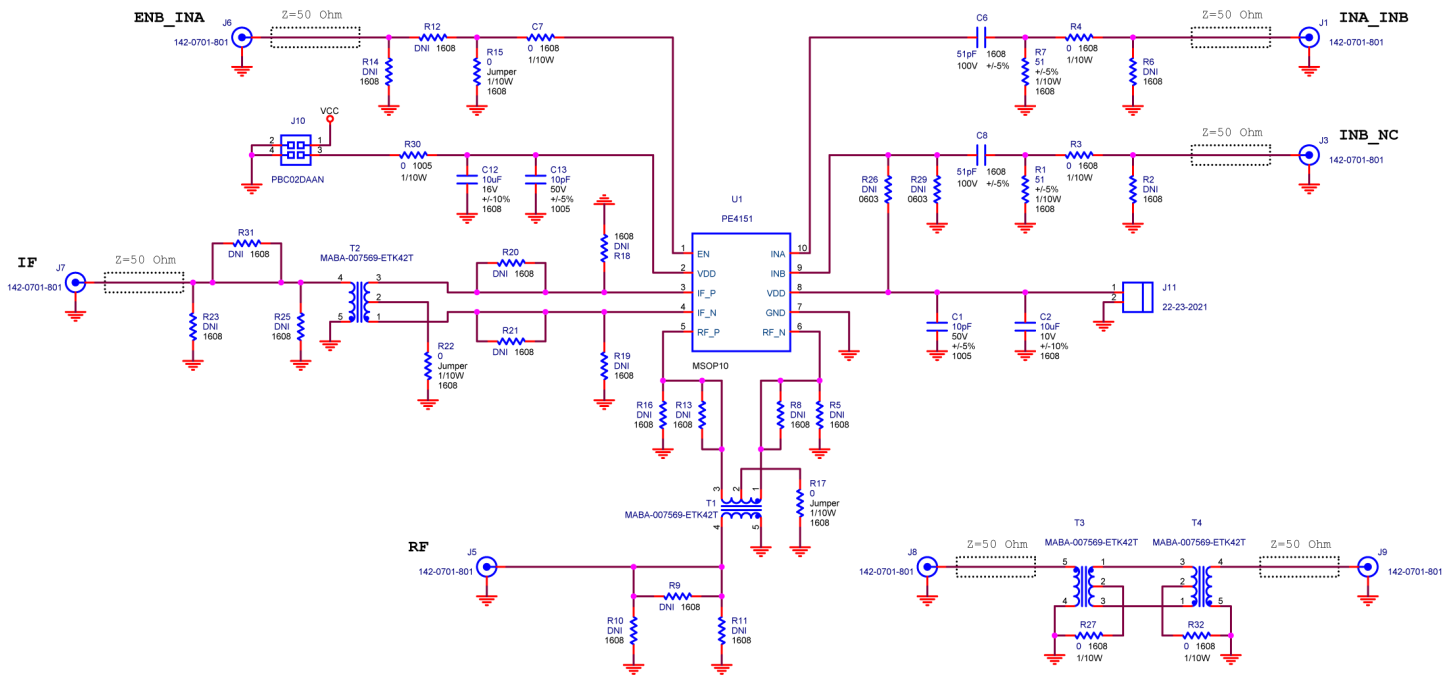

Figure 45. Evaluation Board Schematic



Notes:

1. Caution: contains parts and assemblies susceptible to damage by electrostatic discharge (ESD).
2. LO input can be differential or single ended (INA\_INB/ INB\_NC).
3. With single ended LO input, no termination is needed on

DOC-38627

**Figure 46. Package Drawing**  
10-lead MSOP  
3 × 3 × 0.86 mm

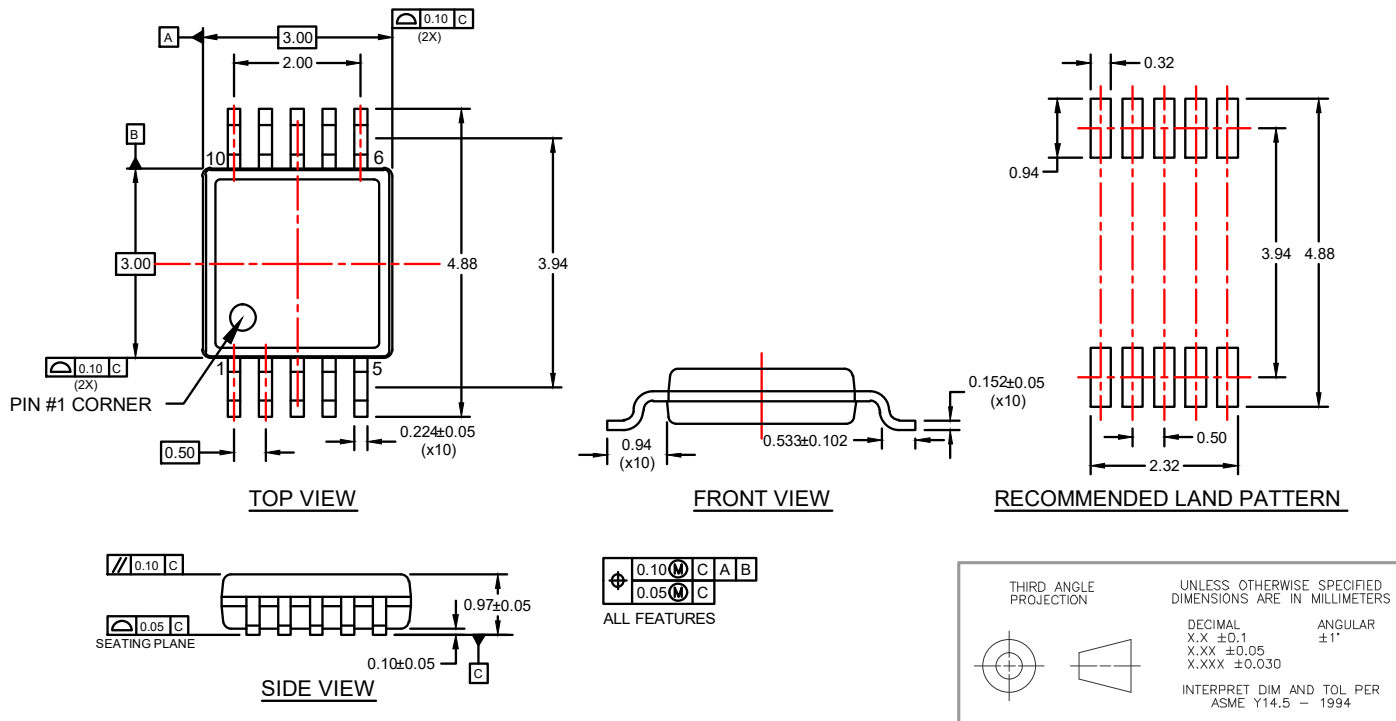

DOC-53337

**Figure 47. Marking Specification**

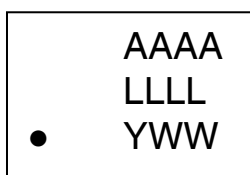

- Pin 1 identification
- AAAA Product number
- LLLL Last four digits of the assembly lot number
- YWW Date code, last digit of the year and two digit work week