

# PE42582

## Document Category: Product Specification

### UltraCMOS® SP8T RF Switch, 9 kHz–8 GHz



## Features

- High isolation: 41 dB @ 6 GHz
- Low insertion loss: 1.1 dB @ 6 GHz
- Fast switching time of 227 ns
- Power handling of 33 dBm CW
- Logic select (LS) pin provides maximum control logic flexibility
- Terminated all-off state mode
- External  $V_{SS}$  pin to eliminate spur
- Packaging – 24-lead 4 × 4 × 0.85 mm QFN

## Applications

- Test and measurement
- Wireless applications up to 8 GHz
- Filter bank switching
- RF signal routing

Figure 1 ■ PE42582 Functional Diagram

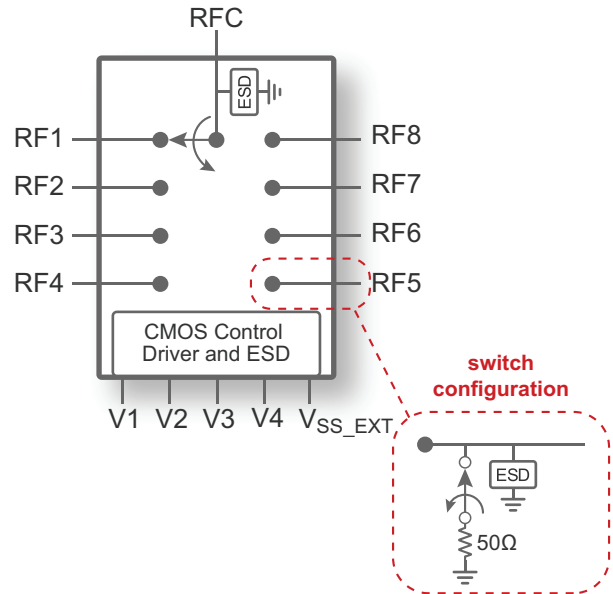

## Product Description

The PE42582 is a HaRP™ technology-enhanced absorptive SP8T RF switch that supports a frequency range from 9 kHz to 8 GHz. An external  $V_{SS}$  pin is available for bypassing the internal negative voltage generator in order for the PE42582 to deliver spur-free performance. It delivers high isolation, low insertion loss and fast switching time, making this device ideal for filter bank switching and RF signal routing in test and measurement (T&M) and wireless applications up to 8 GHz. No blocking capacitors are required if DC voltage is not present on the RF ports.

The PE42582 is manufactured on pSemi's UltraCMOS® process, a patented advanced form of silicon-on-insulator (SOI) technology.

pSemi's HaRP technology enhancements deliver high linearity and excellent harmonics performance. It is an innovative feature of the UltraCMOS process, offering the performance of GaAs with the economy and integration of conventional CMOS.

## Optional External $V_{SS}$

For proper operation, the  $V_{SS\_EXT}$  pin must be grounded or tied to the  $V_{SS}$  voltage specified in **Table 2**. When the  $V_{SS\_EXT}$  pin is grounded, FETs in the switch are biased with an internal negative voltage generator. For applications that require the lowest possible spur performance,  $V_{SS\_EXT}$  can be applied externally to bypass the internal negative voltage generator.

## Absolute Maximum Ratings

Exceeding absolute maximum ratings listed in **Table 1** may cause permanent damage. Operation should be restricted to the limits in **Table 2**. Operation between operating range maximum and absolute maximum for extended periods may reduce reliability.

## ESD Precautions

When handling this UltraCMOS device, observe the same precautions as with any other ESD-sensitive devices. Although this device contains circuitry to protect it from damage due to ESD, precautions should be taken to avoid exceeding the rating specified in **Table 1**.

## Latch-up Immunity

Unlike conventional CMOS devices, UltraCMOS devices are immune to latch-up.

**Table 1** ■ Absolute Maximum Ratings for PE42582

Parameter/Condition	Min	Max	Unit
Supply voltage, $V_{DD}$	-0.3	5.5	V
Digital input voltage (V1, V2, V3, V4, LS)	-0.3	3.6	V
RF input power (RFC–RFX, 50 $\Omega$ )		See <b>Figure 2</b>	dBm
RF input power <a href="#">into</a> terminated ports, CW <sup>(1)</sup> (RFX, 50 $\Omega$ )		See <b>Figure 2</b>	dBm
Maximum junction temperature		+150	$^{\circ}$ C
Storage temperature range	-65	+150	$^{\circ}$ C
ESD voltage HBM, all pins <sup>(1)</sup>		1000	V
ESD voltage CDM, all pins <sup>(3)</sup>		1000	V
<b>Notes:</b>			
1) 100% duty cycle, all bands, 50 $\Omega$ .			
2) Human body model (MIL-STD 883 Method 3015).			
3) Charged device model (JEDEC JESD22-C101).			

## Recommended Operating Conditions

**Table 2** lists the recommended operating conditions for the PE42582. Devices should not be operated outside the recommended operating conditions listed below.

**Table 2** ■ Recommended Operating Conditions for PE42582

Parameter	Min	Typ	Max	Unit
<b>Normal mode (<math>V_{SS\_EXT} = 0V</math>)<sup>(1)</sup></b>				
Supply voltage, $V_{DD}$	2.3	3.3	5.5	V
Supply current, $I_{DD}$		120	200	$\mu A$
<b>Bypass mode (<math>V_{SS\_EXT} = -3.0V</math>)<sup>(2)</sup></b>				
Supply voltage, $V_{DD}$ (Table 3 spec. compliance applies for $V_{DD} \geq 3.4V$ )	3.1	3.4	5.5	V
Supply current, $I_{DD}$		80	160	$\mu A$
Negative supply voltage, $V_{SS\_EXT}$	-3.3	-3.0	-2.7	V
Negative supply current, $I_{SS}$	-40	-16		$\mu A$
<b>Normal or Bypass mode</b>				
Digital input high (V1, V2, V3, V4, LS)	1.17		3.6	V
Digital input low (V1, V2, V3, V4, LS)	-0.3		0.6	V
Digital input current V1, V2, V3, V4 LS			5 10	$\mu A$ $\mu A$
RF input power, CW (RFC–RFX) <sup>(3)</sup>			See Figure 2	dBm
RF input power, pulsed (RFC–RFX) <sup>(4)</sup>			See Figure 2	dBm
RF input power into terminated ports, CW (RFX) <sup>(3)</sup>			See Figure 2	dBm
Operating temperature range	-40	+25	+105	$^{\circ}C$
<b>Notes:</b>				
1) Normal mode: connect $V_{SS\_EXT}$ (pin 7) to GND ( $V_{SS\_EXT} = 0V$ ) to enable internal negative voltage generator.				
2) Bypass mode: use $V_{SS\_EXT}$ (pin 7) to bypass and disable internal negative voltage generator.				
3) 100% duty cycle, all bands, 50 $\Omega$ .				
4) Pulsed, 5% duty cycle of 4620 $\mu s$ period, 50 $\Omega$ .				

## Electrical Specifications

Table 3 provides the PE42582 key electrical specifications at +25 °C ( $Z_S = Z_L = 50\Omega$ ), unless otherwise specified. Normal mode<sup>(1)</sup> is at  $V_{DD} = 3.3V$  and  $V_{SS\_EXT} = 0V$ . Bypass mode<sup>(2)</sup> is at  $V_{DD} = 3.4V$  and  $V_{SS\_EXT} = -3.0V$ .

Table 3 ■ PE42582 Electrical Specifications

Parameter	Path	Condition	Min	Typ	Max	Unit
Operating frequency			9 kHz		8 GHz	As shown
Insertion loss <sup>(3)</sup>	RFC–RF1/8	9 kHz–100 MHz		0.7	0.9	dB
		100 MHz–1 GHz		0.8	1.0	dB
		1–2 GHz		0.9	1.2	dB
		2–4 GHz		0.9	1.5	dB
		4–6 GHz		1.1	1.9	dB
		6–8 GHz		1.6	2.8	dB
	RFC–RF2/7	9 kHz–100 MHz		0.8	1.0	dB
		100 MHz–1 GHz		0.9	1.1	dB
		1–2 GHz		0.9	1.3	dB
		2–4 GHz		1.0	1.6	dB
		4–6 GHz		1.3	2.3	dB
		6–8 GHz		1.3	2.4	dB
	RFC–RF3/6	9 kHz–100 MHz		0.8	1.0	dB
		100 MHz–1 GHz		0.9	1.1	dB
		1–2 GHz		1.0	1.3	dB
		2–4 GHz		1.1	1.7	dB
4–6 GHz			1.2	2.2	dB	
6–8 GHz			1.3	2.2	dB	
RFC–RF4/5	9 kHz–100 MHz		0.9	1.1	dB	
	100 MHz–1 GHz		1.1	1.3	dB	
	1–2 GHz		1.2	1.6	dB	
	2–4 GHz		1.3	1.9	dB	
	4–6 GHz		1.4	2.2	dB	
	6–8 GHz		1.5	2.8	dB	

**Table 3 ■ PE42582 Electrical Specifications (Cont.)**

Parameter	Path	Condition	Min	Typ	Max	Unit
Isolation <sup>(3)</sup>	RFC-RF1/8	9 kHz–100 MHz	61	65		dB
		100 MHz–1 GHz	45	47		dB
		1–2 GHz	39	41		dB
		2–4 GHz	34	36		dB
		4–6 GHz	29	32		dB
		6–8 GHz	25	30		dB
	RFC-RF2/7	9 kHz–100 MHz	63	67		dB
		100 MHz–1 GHz	50	53		dB
		1–2 GHz	45	47		dB
		2–4 GHz	38	41		dB
		4–6 GHz	30	34		dB
		6–8 GHz	29	34		dB
	RFC-RF3/6	9 kHz–100 MHz	64	68		dB
		100 MHz–1 GHz	51	53		dB
		1–2 GHz	46	48		dB
		2–4 GHz	38	40		dB
		4–6 GHz	33	35		dB
		6–8 GHz	29	31		dB
	RFC-RF4/5	9 kHz–100 MHz	81	85		dB
		100 MHz–1 GHz	57	62		dB
1–2 GHz		50	56		dB	
2–4 GHz		45	48		dB	
4–6 GHz		38	41		dB	
6–8 GHz		33	38		dB	

Table 3 ■ PE42582 Electrical Specifications (Cont.)

Parameter	Path	Condition	Min	Typ	Max	Unit
Return loss (active port)	RFC-RF1/8	9 kHz–100 MHz		25		dB
		100 MHz–1 GHz		24		dB
		1–2 GHz		24		dB
		2–4 GHz		21		dB
		4–6 GHz		26		dB
		6–8 GHz		13		dB
	RFC-RF2/7	9 kHz–100 MHz		24		dB
		100 MHz–1 GHz		23		dB
		1–2 GHz		20		dB
		2–4 GHz		18		dB
		4–6 GHz		15		dB
		6–8 GHz		16		dB
	RFC-RF3/6	9 kHz–100 MHz		24		dB
		100 MHz–1 GHz		23		dB
		1–2 GHz		18		dB
		2–4 GHz		15		dB
		4–6 GHz		12		dB
		6–8 GHz		12		dB
	RFC-RF4/5	9 kHz–100 MHz		24		dB
		100 MHz–1 GHz		23		dB
1–2 GHz			17		dB	
2–4 GHz			15		dB	
4–6 GHz			16		dB	
6–8 GHz			18		dB	

**Table 3 ■ PE42582 Electrical Specifications (Cont.)**

Parameter	Path	Condition	Min	Typ	Max	Unit
Return loss (RFC port)	RFC-RF1/8	9 kHz–100 MHz		25		dB
		100 MHz–1 GHz		23		dB
		1–2 GHz		24		dB
		2–4 GHz		23		dB
		4–6 GHz		24		dB
		6–8 GHz		12		dB
	RFC-RF2/7	9 kHz–100 MHz		24		dB
		100 MHz–1 GHz		23		dB
		1–2 GHz		21		dB
		2–4 GHz		19		dB
		4–6 GHz		20		dB
		6–8 GHz		18		dB
	RFC-RF3/6	9 kHz–100 MHz		24		dB
		100 MHz–1 GHz		23		dB
		1–2 GHz		19		dB
		2–4 GHz		16		dB
		4–6 GHz		13		dB
		6–8 GHz		13		dB
	RFC-RF4/5	9 kHz–100 MHz		24		dB
		100 MHz–1 GHz		22		dB
1–2 GHz			18		dB	
2–4 GHz			16		dB	
4–6 GHz			17		dB	
6–8 GHz			17		dB	

Table 3 ■ PE42582 Electrical Specifications (Cont.)

Parameter	Path	Condition	Min	Typ	Max	Unit
Return loss (terminated port)	RF1/8	9 kHz–100 MHz		16		dB
		100 MHz–1 GHz		15		dB
		1–2 GHz		15		dB
		2–4 GHz		15		dB
		4–6 GHz		18		dB
		6–8 GHz		21		dB
	RF2/7	9 kHz–100 MHz		16		dB
		100 MHz–1 GHz		15		dB
		1–2 GHz		15		dB
		2–4 GHz		15		dB
		4–6 GHz		18		dB
		6–8 GHz		19		dB
	RF3/6	9 kHz–100 MHz		16		dB
		100 MHz–1 GHz		15		dB
		1–2 GHz		15		dB
		2–4 GHz		15		dB
		4–6 GHz		16		dB
		6–8 GHz		19		dB
	RF4/5	9 kHz–100 MHz		16		dB
		100 MHz–1 GHz		15		dB
1–2 GHz			15		dB	
2–4 GHz			16		dB	
4–6 GHz			23		dB	
6–8 GHz			16		dB	
Relative insertion phase <sup>(4)</sup>	RF2–RF1 (RF7–RF8)	1 GHz	–2.6	–1.3	0	Deg
		2 GHz	–4.7	–2.4	–0.1	Deg
		4 GHz	–7.5	–3.4	0.8	Deg
		6 GHz	–9.4	–2.8	3.8	Deg
		8 GHz	–1.4	4.4	10.1	Deg
	RF3–RF1 (RF6–RF8)	1 GHz	–3.0	–2.1	–1.3	Deg
		2 GHz	–5.8	–4.0	–2.1	Deg
		4 GHz	–9.3	–5.6	–1.9	Deg
		6 GHz	–11.2	–5.7	–0.3	Deg
		8 GHz	–10.2	–1.0	8.2	Deg
	RF4–RF1 (RF5–RF8)	1 GHz	–6.9	–5.6	–4.3	Deg
		2 GHz	–13.3	–10.7	–8.2	Deg
		4 GHz	–24.7	–18.9	–13.0	Deg
		6 GHz	–35.8	–26.3	–16.9	Deg
		8 GHz	–45.3	–31.5	–17.6	Deg
Input 1dB compression point <sup>(5)</sup>	RFC–RFX			See Figure 2		dBm
Input 0.1dB compression point <sup>(5)</sup>	RFC–RFX			See Figure 2		dBm



**Table 3 ■ PE42582 Electrical Specifications (Cont.)**

Parameter	Path	Condition	Min	Typ	Max	Unit
Input IP2	RFC–RFX	5 MHz 100 MHz–8 GHz		75 105		dBm dBm
Input IP3	RFC–RFX	5 MHz 100 MHz–8 GHz		53 60		dBm dBm
RF T <sub>RISE</sub> /T <sub>FALL</sub>		10%/90% RF		100	130	ns
Settling time		50% CTRL to 0.05 dB final value		870	1400	ns
Switching time		50% CTRL to 90% or 10% of RF		227	290	ns

**Notes:**

- 1) Normal mode: connect V<sub>SS\_EXT</sub> (pin 7) to GND (V<sub>SS\_EXT</sub> = 0V) to enable internal negative voltage generator.
- 2) Bypass mode: use V<sub>SS\_EXT</sub> (pin 7) to bypass and disable internal negative voltage generator.
- 3) Insertion loss and isolation performance can be improved by a good RF ground on the LS pin (pin 1).
- 4) Defined with S-parameters, relative insertion phase (RFX–RF1) = ∠S<sub>(x+1)1</sub> – ∠S<sub>21</sub>, where incident Port-1 is RFC, response Port-2 = RF1, and response Port-(x+1) = RFX.
- 5) The input 1dB and 0.1dB compression points are linearity figures of merit. Refer to Table 2 for the RF input power (50Ω).

### Switching Frequency

The PE42582 has a maximum 25 kHz switching frequency in normal mode (pin 7 tied to ground). A faster switching frequency is available in bypass mode (pin 7 tied to V<sub>SS\_EXT</sub>). The rate at which the PE42582 can be switched is then limited to the switching time as specified in Table 3.

Switching frequency describes the time duration between switching events. Switching time is the time duration between the point the control signal reached 50% of the final value and the point the output signal reaches within 10% or 90% of its target value.

### Spur-Free Performance

The PE42582 spur fundamental occurs around 5 MHz. Its typical performance in normal mode is –162 dBm/Hz (pin 7 tied to ground), with 30 kHz bandwidth. If spur-free performance is desired, the internal negative voltage generator can be disabled by applying a negative voltage to V<sub>SS\_EXT</sub> (pin 7).

### Hot-Switching Capability

The maximum hot switching capability of the PE42582 is 20 dBm above 100 MHz. Hot switching occurs when RF power is applied while switching between RF ports.

### Thermal Data

Psi-JT (Ψ<sub>JT</sub>), junction top-of-package, is a thermal metric to estimate junction temperature of a device on the customer application PCB (JEDEC JESD51-2).

$$\Psi_{JT} = (T_J - T_T)/P$$

where

Ψ<sub>JT</sub> = junction-to-top of package characterization parameter, °C/W

T<sub>J</sub> = die junction temperature, °C

T<sub>T</sub> = package temperature (top surface, in the center), °C

P = power dissipated by device, Watts

**Table 4 ■ Thermal Data for PE42582**

Parameter	Typ	Unit
Ψ <sub>JT</sub>	23	°C/W
Θ <sub>JA</sub> , junction-to-ambient thermal resistance	63	°C/W

## Control Logic

Table 5 provides the control logic truth table for PE42582.

**Table 5 • Truth Table for PE42582**

LS <sup>(1)</sup>	V4	V3	V2	V1	RFC–RF1	RFC–RF2	RFC–RF3	RFC–RF4	RFC–RF5	RFC–RF6	RFC–RF7	RFC–RF8
0	0	0	0	0	ON	OFF	OFF	OFF	OFF	OFF	OFF	OFF
0	0	1	0	0	OFF	ON	OFF	OFF	OFF	OFF	OFF	OFF
0	0	0	1	0	OFF	OFF	ON	OFF	OFF	OFF	OFF	OFF
0	0	1	1	0	OFF	OFF	OFF	ON	OFF	OFF	OFF	OFF
0	0	0	0	1	OFF	OFF	OFF	OFF	ON	OFF	OFF	OFF
0	0	1	0	1	OFF	OFF	OFF	OFF	OFF	ON	OFF	OFF
0	0	0	1	1	OFF	OFF	OFF	OFF	OFF	OFF	ON	OFF
0	0	1	1	1	OFF	OFF	OFF	OFF	OFF	OFF	OFF	ON
1	0	1	1	1	ON	OFF	OFF	OFF	OFF	OFF	OFF	OFF
1	0	0	1	1	OFF	ON	OFF	OFF	OFF	OFF	OFF	OFF
1	0	1	0	1	OFF	OFF	ON	OFF	OFF	OFF	OFF	OFF
1	0	0	0	1	OFF	OFF	OFF	ON	OFF	OFF	OFF	OFF
1	0	1	1	0	OFF	OFF	OFF	OFF	ON	OFF	OFF	OFF
1	0	0	1	0	OFF	OFF	OFF	OFF	OFF	ON	OFF	OFF
1	0	1	0	0	OFF	OFF	OFF	OFF	OFF	OFF	ON	OFF
1	0	0	0	0	OFF	OFF	OFF	OFF	OFF	OFF	OFF	ON
X <sup>(2)</sup>	1	0	0	0	OFF	OFF	OFF	OFF	OFF	OFF	OFF	OFF

**Notes:**

- 1) LS has an internal 1 MΩ pull-up resistor to logic high. Connect LS to GND externally to generate a logic 0. Leaving LS floating will generate a logic 1.
- 2) LS = don't care, V4 = 1, V3 = V2 = V1 = 0, all ports are terminated to provide an all isolated state.

## Power De-rating Curve

Figure 2 shows the power de-rating curve showing P1dB compression, P0.1dB compression, maximum RF input power (pulsed), maximum RF input power (CW), absolute maximum RF terminated power (CW), and maximum RF terminated power (CW).

Figure 2 ■ Power De-rating Curve, 9 kHz–8 GHz, –40 °C to +105 °C Ambient, 50?

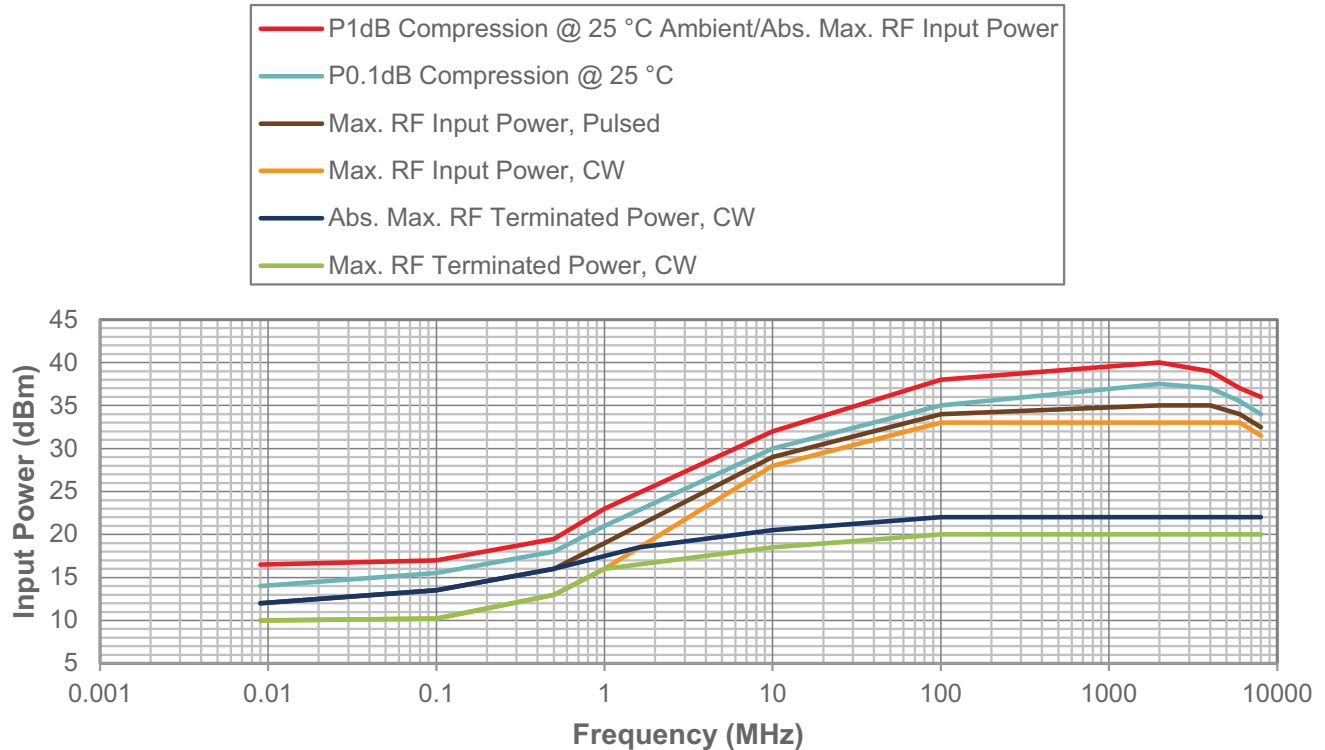

## Isolation Matrix

Table 6 provides RFC-to-port isolation and Table 7 provides port-to-port isolation at +25 °C,  $V_{DD} = 3.3V$  ( $Z_S = Z_L = 50\Omega$ ). Normal mode<sup>(1)</sup> is at  $V_{DD} = 3.3V$  and  $V_{SS\_EXT} = 0V$ . Bypass mode<sup>(2)</sup> is at  $V_{DD} = 3.4V$  and  $V_{SS\_EXT} = -3.0V$ .

Table 6 ■ RFC-to-Port Isolation

"ON" Port	Frequency	Isolation (dB)							
		RF1	RF2	RF3	RF4	RF5	RF6	RF7	RF8
RF1	9 kHz–100 MHz	–	69	68	85	91	88	87	79
	100 MHz–1 GHz	–	62	53	62	74	66	64	57
	1–2 GHz	–	57	48	56	68	60	58	51
	2–4 GHz	–	48	40	49	63	54	52	45
	4–6 GHz	–	37	35	44	55	50	46	42
	6–8 GHz	–	34	31	41	56	47	45	38
RF2	9 kHz–100 MHz	67	–	69	90	91	88	86	77
	100 MHz–1 GHz	52	–	60	67	74	66	64	56
	1–2 GHz	46	–	57	62	68	60	57	50
	2–4 GHz	39	–	49	54	63	53	52	45
	4–6 GHz	32	–	43	49	56	50	46	42
	6–8 GHz	30	–	37	46	55	47	46	40
RF3	9 kHz–100 MHz	65	68	–	86	91	88	85	77
	100 MHz–1 GHz	47	55	–	66	74	66	63	55
	1–2 GHz	42	51	–	57	68	60	57	50
	2–4 GHz	36	44	–	50	63	53	52	45
	4–6 GHz	33	40	–	42	56	49	47	42
	6–8 GHz	31	36	–	39	55	46	47	40
RF4	9 kHz–100 MHz	65	67	68	–	90	89	85	76
	100 MHz–1 GHz	47	53	56	–	75	66	63	55
	1–2 GHz	41	47	51	–	69	59	57	49
	2–4 GHz	36	41	44	–	63	53	51	44
	4–6 GHz	33	36	38	–	55	49	46	41
	6–8 GHz	32	34	34	–	50	47	47	40
RF5	9 kHz–100 MHz	73	84	89	90	–	68	68	66
	100 MHz–1 GHz	51	61	65	75	–	57	53	49
	1–2 GHz	45	56	59	68	–	52	48	44
	2–4 GHz	40	49	52	61	–	45	41	38
	4–6 GHz	37	45	48	56	–	39	36	35
	6–8 GHz	34	43	46	51	–	34	35	34
RF6	9 kHz–100 MHz	73	84	88	93	85	–	68	66
	100 MHz–1 GHz	51	62	65	73	64	–	56	50
	1–2 GHz	45	56	59	67	56	–	51	45
	2–4 GHz	40	49	53	61	48	–	46	39
	4–6 GHz	37	46	49	57	41	–	38	35
	6–8 GHz	34	44	45	55	38	–	37	33

Table 6 ■ RFC-to-Port Isolation (Cont.)

“ON” Port	Frequency	Isolation (dB)							
		RF1	RF2	RF3	RF4	RF5	RF6	RF7	RF8
RF7	9 kHz–100 MHz	73	84	89	92	88	69	–	68
	100 MHz–1 GHz	51	62	65	73	68	60	–	57
	1–2 GHz	45	56	59	67	63	57	–	52
	2–4 GHz	40	49	53	61	56	50	–	44
	4–6 GHz	37	45	49	57	50	41	–	33
	6–8 GHz	34	43	46	56	47	38	–	33
RF8	9 kHz–100 MHz	74	84	87	93	85	68	69	–
	100 MHz–1 GHz	52	62	66	73	63	54	65	–
	1–2 GHz	46	57	60	67	57	48	60	–
	2–4 GHz	40	49	53	60	50	41	51	–
	4–6 GHz	37	46	49	57	46	35	34	–
	6–8 GHz	33	42	46	55	42	31	35	–

Notes:

- 1) Normal mode: connect V<sub>SS\_EXT</sub> (pin 7) to GND (V<sub>SS\_EXT</sub> = 0V) to enable internal negative voltage generator.
- 2) Bypass mode: use V<sub>SS\_EXT</sub> (pin 7) to bypass and disable internal negative voltage generator.

Table 7 ■ Port-to-Port Isolation

“ON” Port	Frequency	Isolation (dB)							
		RF1	RF2	RF3	RF4	RF5	RF6	RF7	RF8
RF1	9 kHz–100 MHz	–	65	67	84	91	89	89	88
	100 MHz–1 GHz	–	47	51	59	75	69	71	64
	1–2 GHz	–	41	45	53	70	63	65	60
	2–4 GHz	–	35	39	47	64	57	60	53
	4–6 GHz	–	31	34	43	57	52	47	45
	6–8 GHz	–	29	30	40	57	49	47	43
RF2	9 kHz–100 MHz	65	–	64	78	90	91	92	89
	100 MHz–1 GHz	46	–	45	55	75	70	75	74
	1–2 GHz	41	–	39	49	69	64	69	72
	2–4 GHz	35	–	34	43	65	58	64	63
	4–6 GHz	32	–	30	41	57	53	50	51
	6–8 GHz	29	–	27	38	58	50	50	51
RF3	9 kHz–100 MHz	67	65	–	69	94	90	92	91
	100 MHz–1 GHz	51	47	–	47	75	70	78	80
	1–2 GHz	46	41	–	41	70	64	72	79
	2–4 GHz	40	36	–	36	65	58	66	68
	4–6 GHz	37	33	–	33	57	53	51	54
	6–8 GHz	33	30	–	30	57	50	51	54

Table 7 ■ Port-to-Port Isolation (Cont.)

“ON” Port	Frequency	Isolation (dB)							
		RF1	RF2	RF3	RF4	RF5	RF6	RF7	RF8
RF4	9 kHz–100 MHz	68	67	63	–	90	89	89	91
	100 MHz–1 GHz	53	52	44	–	71	69	78	79
	1–2 GHz	47	46	39	–	66	64	71	80
	2–4 GHz	42	41	33	–	61	58	65	68
	4–6 GHz	38	36	30	–	54	53	50	54
	6–8 GHz	34	35	28	–	55	50	50	54
RF5	9 kHz–100 MHz	88	91	89	90	–	63	67	68
	100 MHz–1 GHz	79	80	70	71	–	44	52	52
	1–2 GHz	66	73	64	66	–	39	46	46
	2–4 GHz	57	66	58	61	–	33	41	40
	4–6 GHz	50	52	53	55	–	30	36	36
	6–8 GHz	47	53	51	56	–	28	35	33
RF6	9 kHz–100 MHz	90	92	89	91	69	–	65	67
	100 MHz–1 GHz	77	82	70	75	46	–	47	51
	1–2 GHz	65	75	65	70	41	–	42	45
	2–4 GHz	56	66	58	64	35	–	36	39
	4–6 GHz	49	52	53	59	33	–	32	35
	6–8 GHz	46	53	50	57	30	–	31	32
RF7	9 kHz–100 MHz	92	92	89	90	78	64	–	64
	100 MHz–1 GHz	85	77	70	76	55	45	–	45
	1–2 GHz	70	72	64	71	50	39	–	40
	2–4 GHz	57	64	58	65	44	34	–	35
	4–6 GHz	48	52	53	59	40	30	–	29
	6–8 GHz	46	51	50	57	39	27	–	30
RF8	9 kHz–100 MHz	87	91	88	90	82	67	65	–
	100 MHz–1 GHz	69	73	69	75	59	51	47	–
	1–2 GHz	67	67	63	70	54	45	41	–
	2–4 GHz	56	61	57	64	47	39	35	–
	4–6 GHz	46	49	52	59	43	34	29	–
	6–8 GHz	42	49	49	56	41	30	29	–

## Typical Performance Data

Figure 3–Figure 20 show the typical performance data at +25 °C,  $V_{DD} = 3.3V$  ( $Z_S = Z_L = 50\Omega$ ), unless otherwise specified.

Figure 3 ■ Insertion Loss vs. Frequency (RFC–RFX)

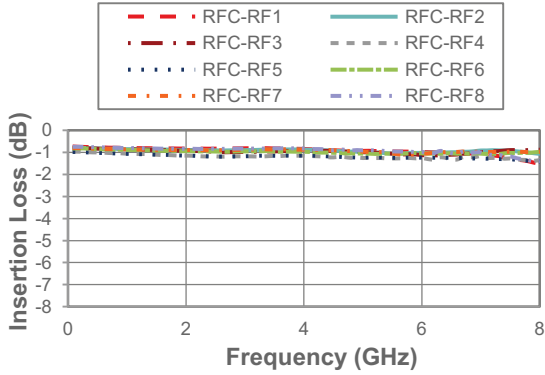

Figure 5 ■ Insertion Loss vs. Frequency Over  $V_{DD}$  (RFC–RF1)

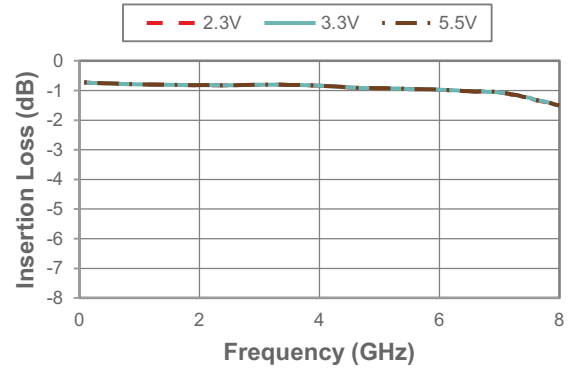

Figure 4 ■ Insertion Loss vs. Frequency Over Temperature (RFC–RF1)

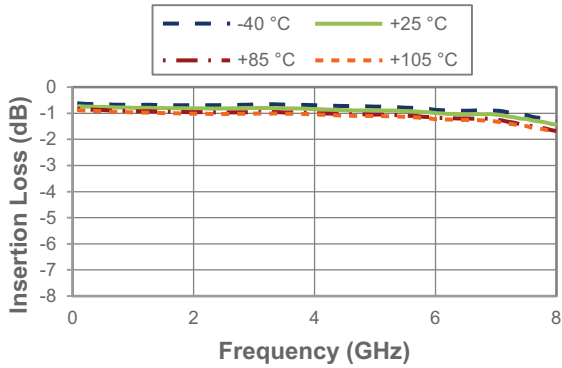

Figure 6 ■ RFC Port Return Loss vs. Frequency

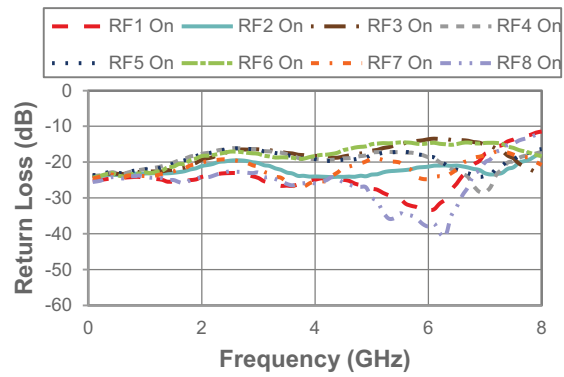

Figure 7 ■ RFC Port Return Loss vs. Frequency Over Temperature (RF1 On)

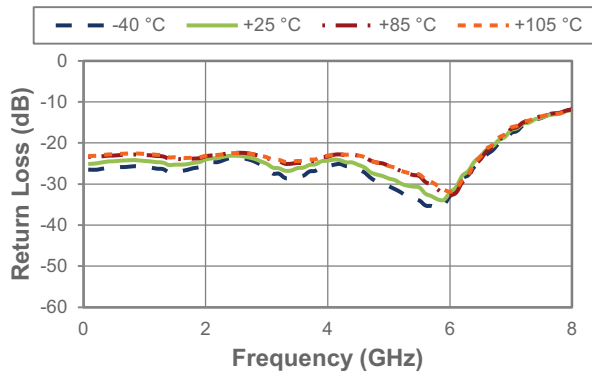

Figure 10 ■ RF1 Active Port Return Loss vs. Frequency Over Temperature

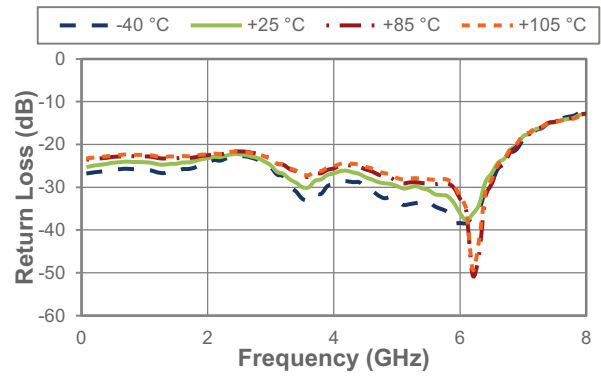

Figure 8 ■ RFC Port Return Loss vs. Frequency Over  $V_{DD}$  (RF1 On)

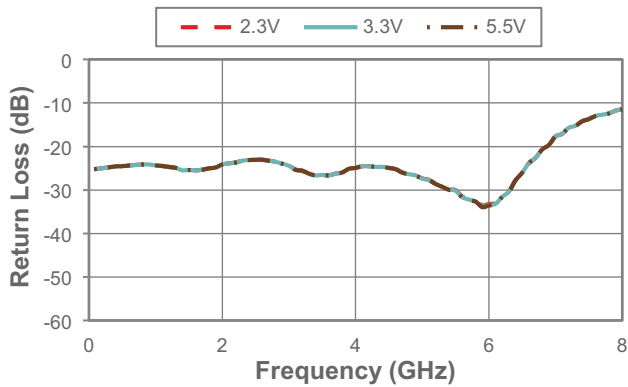

Figure 11 ■ RF1 Active Port Return Loss vs. Frequency Over  $V_{DD}$

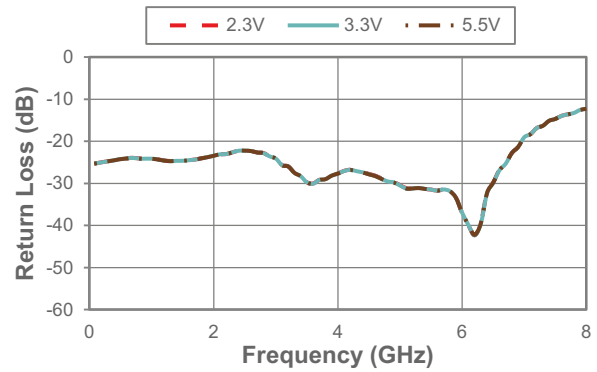

Figure 9 ■ Active Port Return Loss vs. Frequency

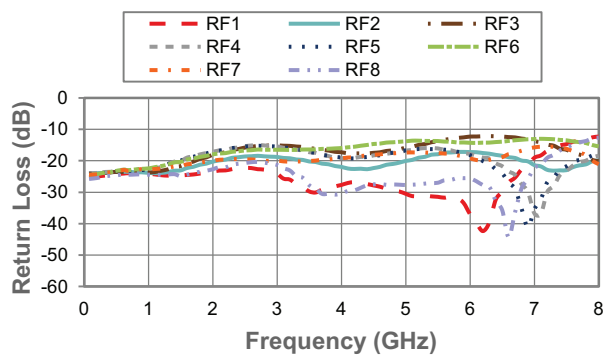
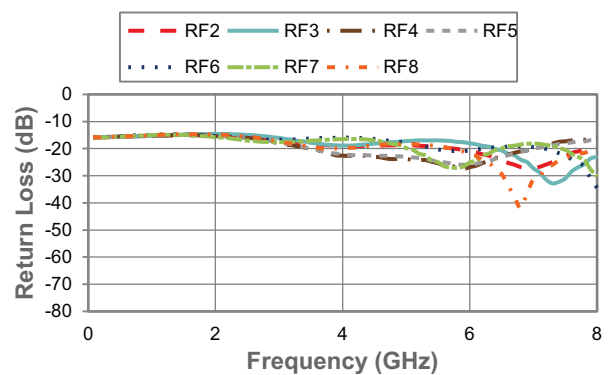
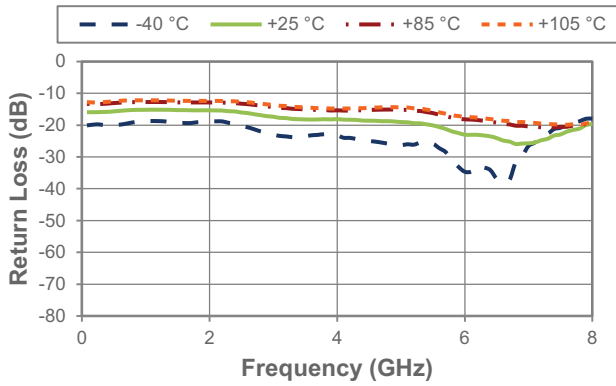

Figure 12 ■ Terminated Port Return Loss vs. Frequency (RF1 On)

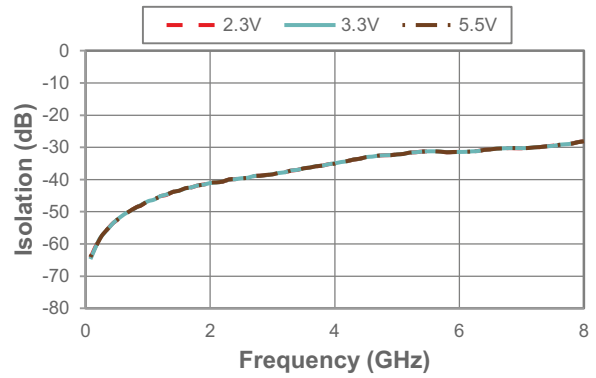



**Figure 13** ■ RF2 Terminated Port Return Loss vs. Frequency Over Temperature (RF1 On)



**Figure 16** ■ Isolation vs. Frequency Over  $V_{DD}$  (RF1–RF2, RF1 On)



**Figure 14** ■ RF2 Terminated Port Return Loss vs. Frequency Over  $V_{DD}$  (RF1 On)

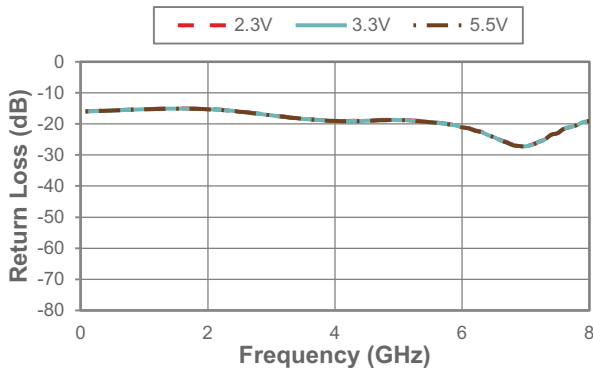

**Figure 17** ■ Isolation vs. Frequency Over Temperature (RFC–RF2, RF1 On)

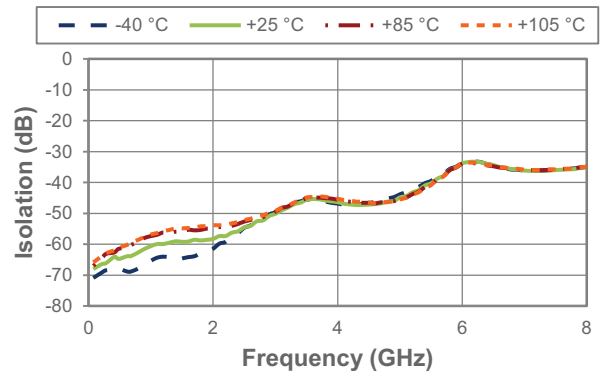

**Figure 15** ■ Isolation vs. Frequency Over Temperature (RFX–RFX, RF1–RF2, RF1 On)

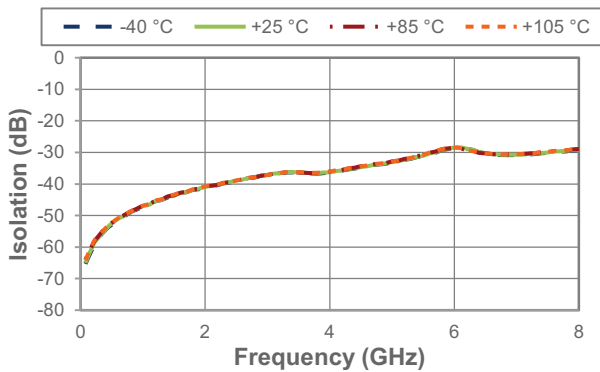

**Figure 18** ■ Isolation vs. Frequency Over  $V_{DD}$  (RFC–RF2, RF1 On)

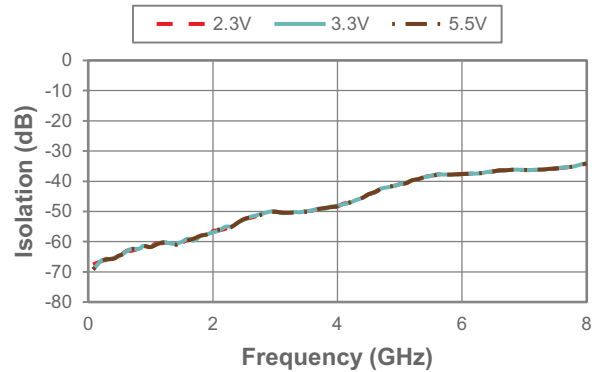

Figure 19 ■ IIP2 vs. RF Port Measured

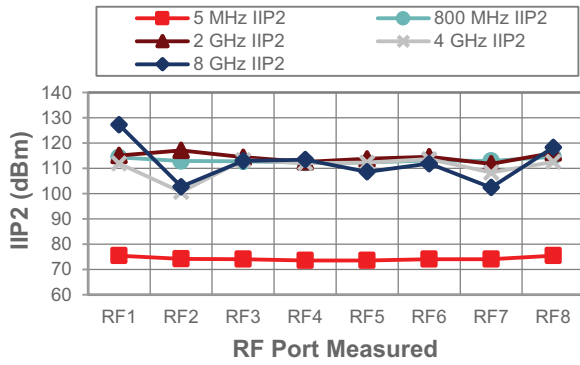
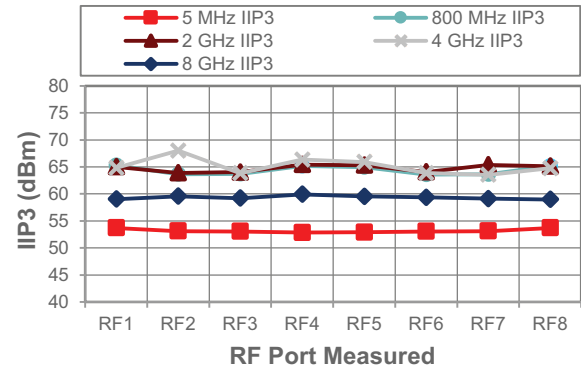

Figure 20 ■ IIP3 vs. RF Port Measured



## Evaluation Kit

The high-throw count RF switch evaluation kit (EVK) includes hardware required to control and evaluate the functionality of the high-throw count switches. The high-throw count RF switch evaluation software can be downloaded at [www.psemi.com](http://www.psemi.com) and requires a PC running Windows® operating system to control the USB interface board. Refer to the *Multi-throw Count RF Switch Evaluation Kit (EVK) User's Manual* for more information.

Figure 21 ■ Evaluation Board Layout for PE42582

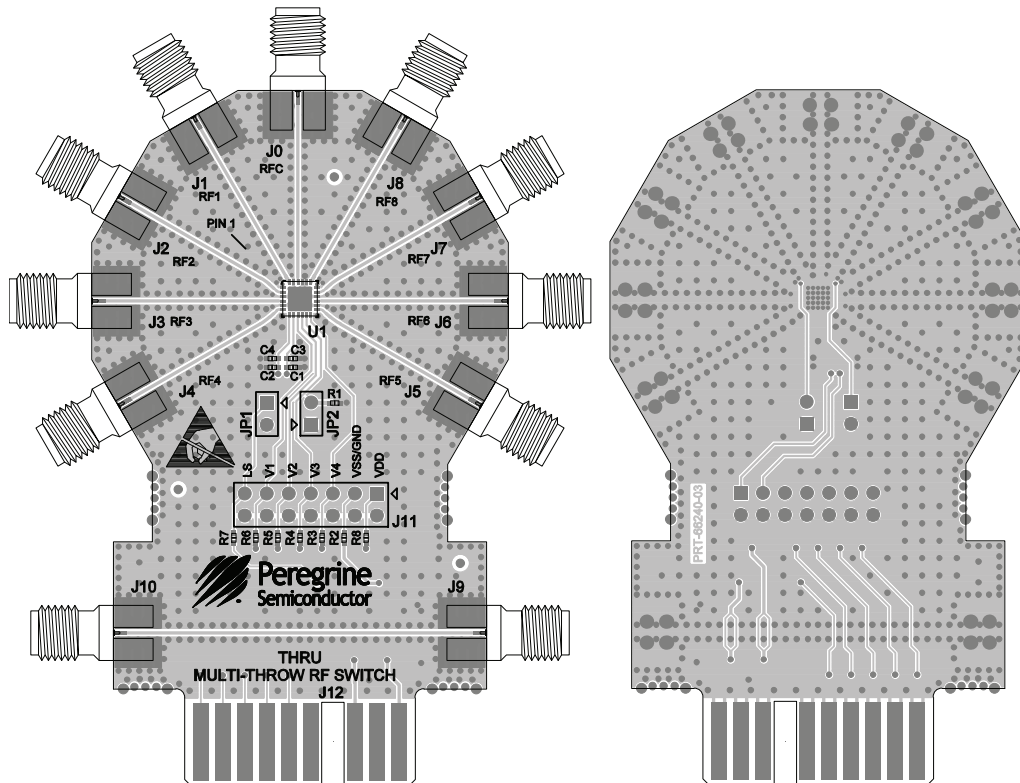

## Pin Information

This section provides pinout information for the PE42582. **Figure 22** shows the pin map of this device for the available package. **Table 8** provides a description for each pin.

**Figure 22** ■ Pin Configuration (Top View)

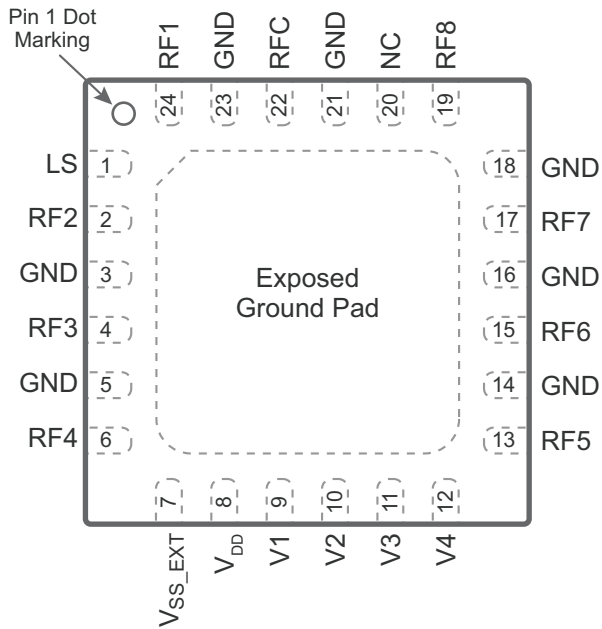

**Table 8** ■ Pin Descriptions for PE42582

Pin No.	Pin Name	Description
1	LS	Logic Select—used to determine the definition for V1, V2, V3 and V4 pins
2	RF2 <sup>(1)</sup>	RF port 2
3, 5, 14, 16, 18, 21, 23	GND	Ground
4	RF3 <sup>(1)</sup>	RF port 3
6	RF4 <sup>(1)</sup>	RF port 4
7	V <sub>SS_EXT</sub> <sup>(2)</sup>	External V <sub>SS</sub> negative voltage control
8	VDD	Supply voltage (nominal 3.3V)
9	V1	Digital control logic input 1
10	V2	Digital control logic input 2
11	V3	Digital control logic input 3
12	V4	Digital control logic input 4
13	RF5 <sup>(1)</sup>	RF port 5
15	RF6 <sup>(1)</sup>	RF port 6
17	RF7 <sup>(1)</sup>	RF port 7
19	RF8 <sup>(1)</sup>	RF port 8
20	NC <sup>(3)</sup>	No connect
22	RFC <sup>(1)</sup>	RF common port
24	RF1 <sup>(1)</sup>	RF port 1
Pad	GND	Exposed pad: ground for proper operation

**Notes:**

- 1) RF pins 2, 4, 6, 13, 15, 17, 19, 22, and 24 must be at 0 VDC. The RF pins do not require DC blocking capacitors for proper operation if the 0 VDC requirement is met.
- 2) Use V<sub>SS\_EXT</sub> (pin 7) to bypass and disable internal negative voltage generator. Connect V<sub>SS\_EXT</sub> (pin 7) to GND (V<sub>SS\_EXT</sub> = 0V) to enable internal negative voltage generator.
- 3) Pin 20 (NC) can be connected to GND or left not connected externally.

## Packaging Information

This section provides packaging data including the moisture sensitivity level, package drawing, package marking and tape-and-reel information.

### Moisture Sensitivity Level

The moisture sensitivity level rating for the PE42582 in the 24-lead 4 × 4 × 0.85 mm QFN package is MSL1.

### Package Drawing

Figure 23 ■ Package Mechanical Drawing for 24-lead 4 × 4 × 0.85 mm QFN

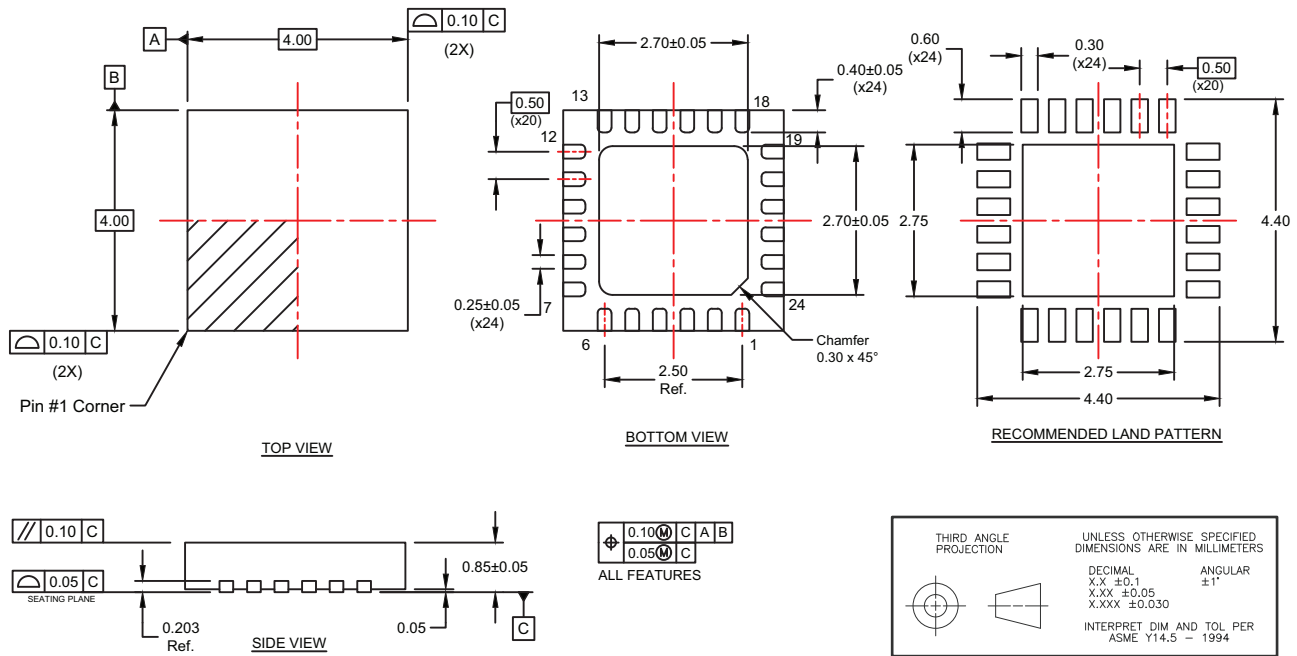

### Top-Marking Specification

Figure 24 ■ Package Marking Specifications for PE42582

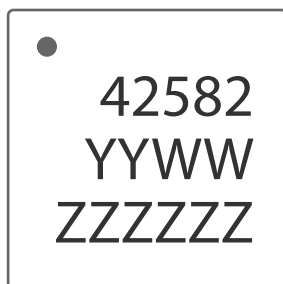

- = Pin 1 indicator
- YY = Last two digits of assembly year
- WW = Assembly work week
- ZZZZZZ = Assembly lot code (Maximum six characters)

## Tape and Reel Specification

Figure 25 ■ Tape and Reel Specifications for 24-lead 4 × 4 × 0.85 mm QFN

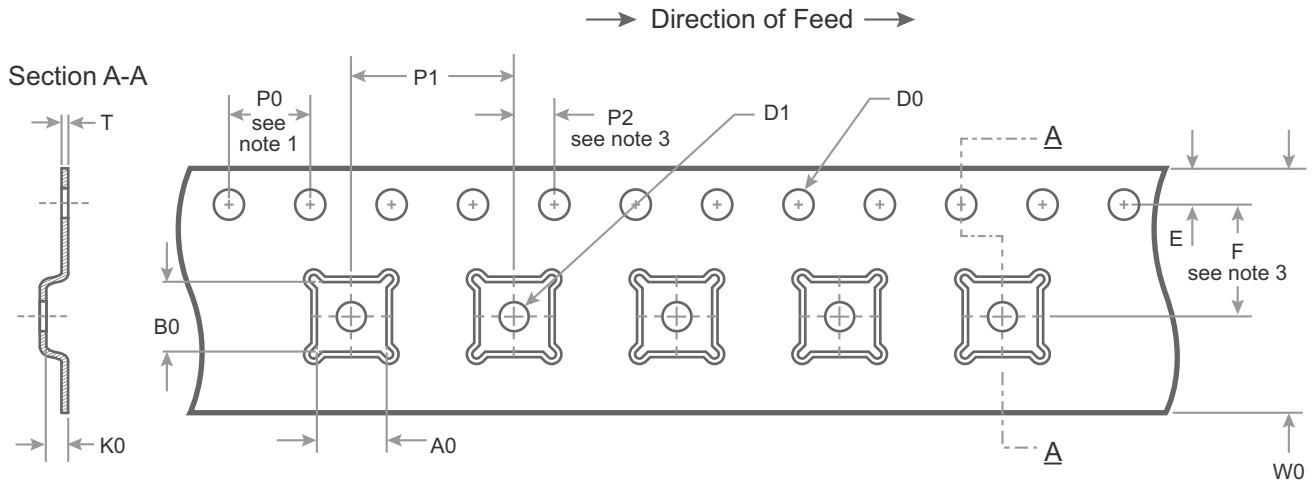

A0	4.35
B0	4.35
K0	1.10
D0	1.50 + 0.10/ -0.00
D1	1.50 min
E	1.75 ± 0.10
F	5.50 ± 0.05
P0	4.00
P1	8.00
P2	2.00 ± 0.05
T	0.30 ± 0.05
W0	12.00 ± 0.30

### Notes:

1. 10 Sprocket hole pitch cumulative tolerance ±0.2
2. Camber in compliance with EIA 481
3. Pocket position relative to sprocket hole measured as true position of pocket, not pocket hole

Dimensions are in millimeters unless otherwise specified

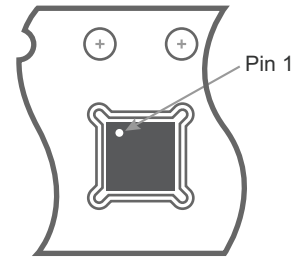

Device Orientation in Tape