



# PJU4NA60 / PJD4NA60 / PJP4NA60 / PJF4NA60

## 600V N-Channel MOSFET

**Voltage**

**600 V**

**Current**

**4 A**

### Features

- $R_{DS(ON)}, V_{GS}@10V, I_D@2A < 2.4\Omega$
- High switching speed
- Improved dv/dt capability
- Low Gate Charge
- Low reverse transfer capacitance
- Lead free in compliance with EU RoHS 2011/65/EU directive.
- Green molding compound as per IEC61249 Std.  
(Halogen Free)

### Mechanical Data

- Case: TO-251AA, TO-252AA, TO-220AB, ITO-220AB-F Package
- Terminals : Solderable per MIL-STD-750, Method 2026
- TO-251AA Approx. Weight : 0.0104 ounces, 0.297grams
- TO-252AA Approx. Weight : 0.0104 ounces, 0.297grams
- TO-220AB Approx. Weight : 0.067 ounces, 1.9 grams
- ITO-220AB-F Approx. Weight : 0.068 ounces, 2 grams

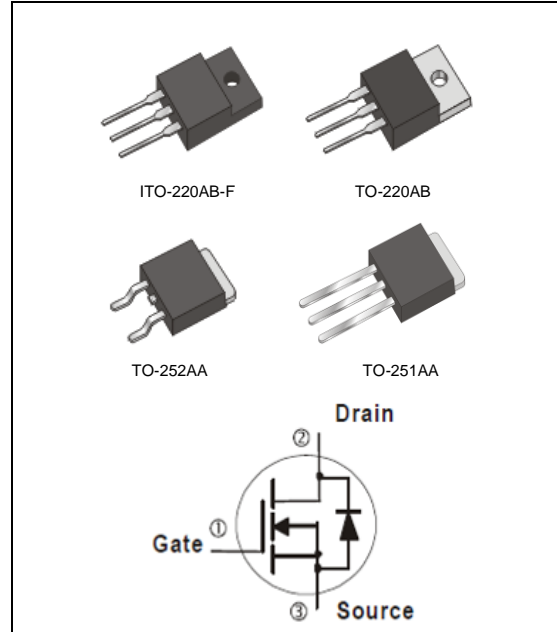

### Maximum Ratings and Thermal Characteristics ( $T_A=25^\circ\text{C}$ unless otherwise noted)

| PARAMETER   |                                 | SYMBOL          | TO-251AA | TO-220AB | ITO-220AB-F | TO-252AA | UNITS               |
|---|---------------------------------|-----------------|----------|----------|-------------|----------|---------------------|
| Drain-Source Voltage                              |                                 | $V_{DS}$        | 600      |          |             |          | V                   |
| Gate-Source Voltage                               |                                 | $V_{GS}$        | $\pm 30$ |          |             |          | V                   |
| Continuous Drain Current                          |                                 | $I_D$           | 4        |          |             |          | A                   |
| Pulsed Drain Current                              |                                 | $I_{DM}$        | 16       |          |             |          | A                   |
| Single Pulse Avalanche Energy <sup>(Note 1)</sup> |                                 | $E_{AS}$        | 217      |          |             |          | mJ                  |
| Power Dissipation                                 | $T_C=25^\circ\text{C}$          | $P_D$           | 77       | 100      | 33          | 77       | W                   |
|   | Derate above $25^\circ\text{C}$ |                 | 0.62     | 0.8      | 0.26        | 0.62     | W/ $^\circ\text{C}$ |
| Operating Junction and Storage Temperature Range  |                                 | $T_J, T_{STG}$  | -55~150  |          |             |          | $^\circ\text{C}$    |
| Typical Thermal resistance                        |                                 |                 |          |          |             |          |                     |
| - Junction to Case                                |                                 | $R_{\theta JC}$ | 1.62     | 1.25     | 3.79        | 1.62     | $^\circ\text{C/W}$  |
| - Junction to Ambient                             |                                 | $R_{\theta JA}$ | 110      | 62.5     | 120         | 110      |                     |

- Limited only By Maximum Junction Temperature



## PJU4NA60 / PJD4NA60 / PJP4NA60 / PJF4NA60

### Electrical Characteristics ( $T_A=25^\circ\text{C}$ unless otherwise noted)

| PARAMETER   | SYMBOL       | TEST CONDITION                                      | MIN. | TYP.     | MAX.      | UNITS    |
|---|--------------|---|------|----------|-----------|----------|
| <b>Static</b>   |              |   |      |          |           |          |
| Drain-Source Breakdown Voltage                        | $BV_{DSS}$   | $V_{GS}=0V, I_D=250\mu A$                           | 600  | -        | -         | V        |
| Gate Threshold Voltage                                | $V_{GS(th)}$ | $V_{DS}=V_{GS}, I_D=250\mu A$                       | 2    | 3.2      | 4         | V        |
| Drain-Source On-State Resistance                      | $R_{DS(on)}$ | $V_{GS}=10V, I_D=2A$                                | -    | 1.92     | 2.4       | $\Omega$ |
| Zero Gate Voltage Drain Current                       | $I_{DSS}$    | $V_{DS}=600V, V_{GS}=0V$                            | -    | 0.03     | 1.0       | $\mu A$  |
| Gate-Source Leakage Current                           | $I_{GSS}$    | $V_{GS}=\pm 30V, V_{DS}=0V$                         | -    | $\pm 10$ | $\pm 100$ | nA       |
| Diode Forward Voltage                                 | $V_{SD}$     | $I_S=4A, V_{GS}=0V$                                 | -    | 0.86     | 1.4       | V        |
| <b>Dynamic</b> (Note 4)                               |              |   |      |          |           |          |
| Total Gate Charge                                     | $Q_g$        | $V_{DS}=480V, I_D=4A,$<br>$V_{GS}=10V$ (Note 2,3)   | -    | 11.1     | -         | nC       |
| Gate-Source Charge                                    | $Q_{gs}$     |   | -    | 3.3      | -         |          |
| Gate-Drain Charge                                     | $Q_{gd}$     |   | -    | 4.2      | -         |          |
| Input Capacitance                                     | $C_{iss}$    | $V_{DS}=25V, V_{GS}=0V,$<br>$f=1.0\text{MHz}$       | -    | 450      | -         | pF       |
| Output Capacitance                                    | $C_{oss}$    |   | -    | 67       | -         |          |
| Reverse Transfer Capacitance                          | $C_{rss}$    |   | -    | 0.7      | -         |          |
| Turn-On Delay Time                                    | $t_{d(on)}$  | $V_{DD}=300V, I_D=4A,$<br>$R_G=25\Omega$ (Note 2,3) | -    | 10       | -         | ns       |
| Turn-On Rise Time                                     | $t_r$        |   | -    | 23       | -         |          |
| Turn-Off Delay Time                                   | $t_{d(off)}$ |   | -    | 24       | -         |          |
| Turn-Off Fall Time                                    | $t_f$        |   | -    | 24       | -         |          |
| <b>Drain-Source Diode</b>                             |              |   |      |          |           |          |
| Maximum Continuous Drain-Source Diode Forward Current | $I_S$        | ---   | -    | -        | 4         | A        |
| Maximum Pulsed Drain-Source Diode Forward Current     | $I_{SM}$     | ---   | -    | -        | 16        | A        |
| Reverse Recovery Time                                 | $t_{rr}$     | $V_{GS}=0V, I_S=4A$                                 | -    | 400      | -         | ns       |
| Reverse Recovery Charge                               | $Q_{rr}$     | $di_f/dt=100A/\mu s$ (Note 2)                       | -    | 1.7      | -         | $\mu C$  |

NOTES :

1.  $L=30\text{mH}, I_{AS}=3.7A, V_{DD}=50V, R_G=25\text{ohm}$ , Starting  $T_J=25^\circ\text{C}$
2. Pulse width  $\leq 300\mu s$ , Duty cycle  $\leq 2\%$
3. Essentially independent of operating temperature typical characteristics.
4. Guaranteed by design, not subject to production testing



# PJU4NA60 / PJD4NA60 / PJP4NA60 / PJF4NA60

## TYPICAL CHARACTERISTIC CURVES

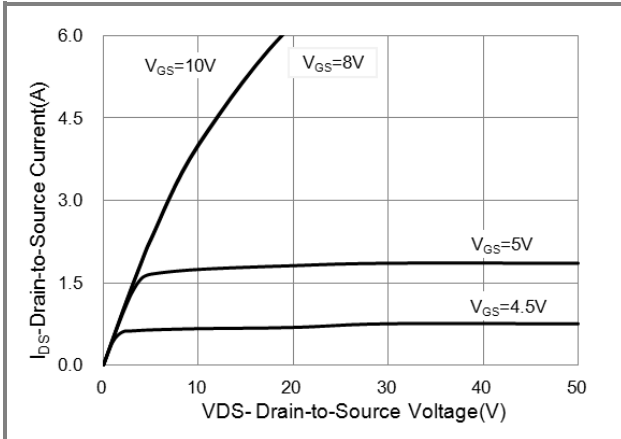

Fig.1 Output Characteristics

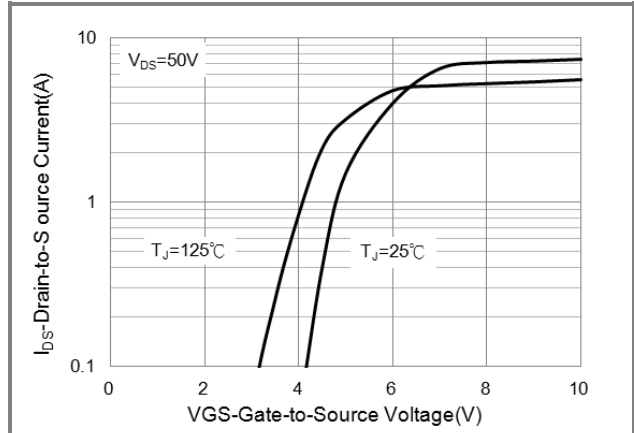

Fig.2 Transfer Characteristics

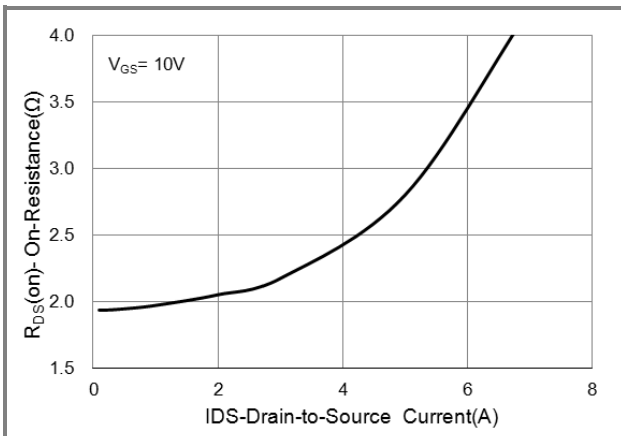

Fig.3 On-Resistance vs. Drain Current

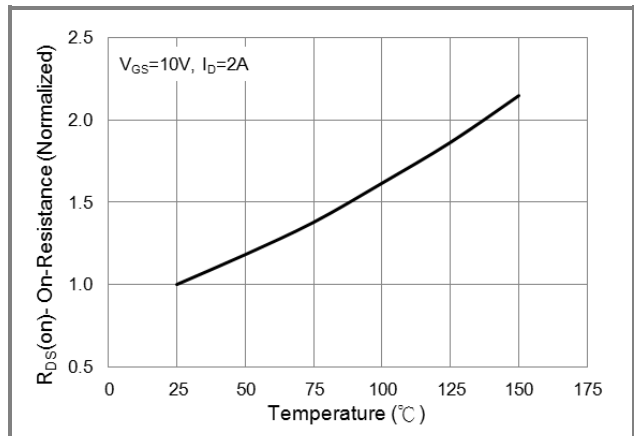

Fig.4 On-Resistance vs. Junction Temperature

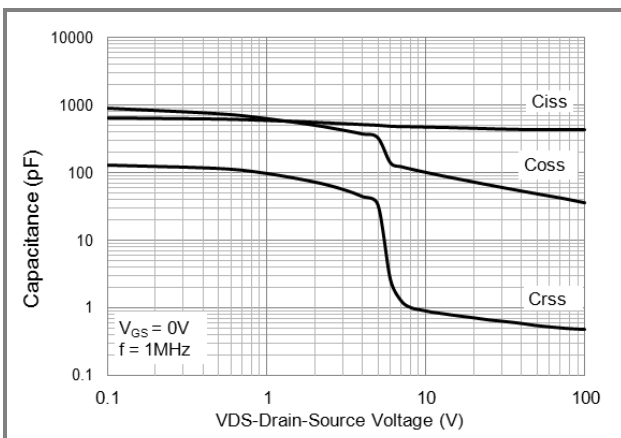

Fig.5 Capacitance vs. Drain-Source Voltage

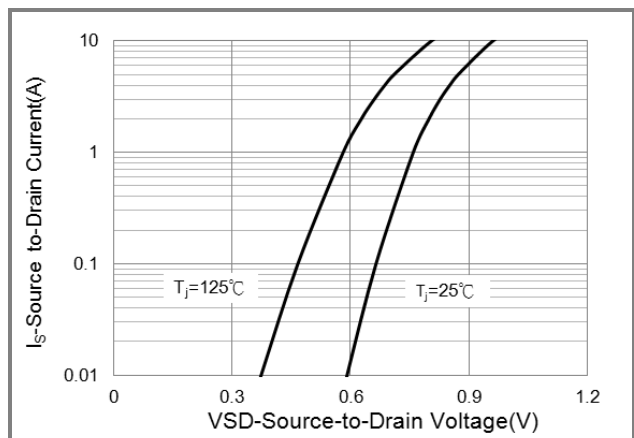
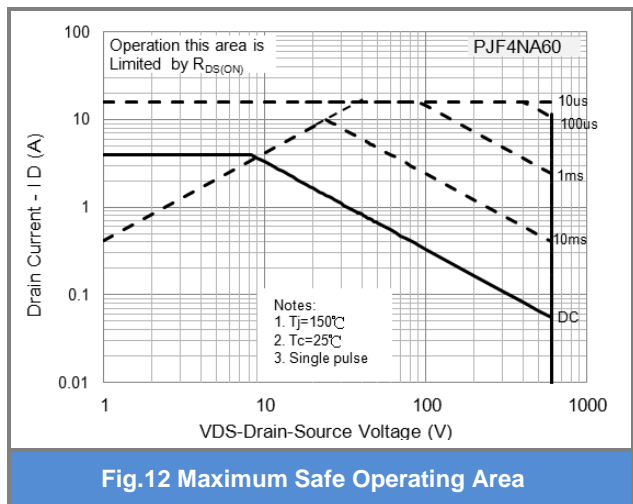
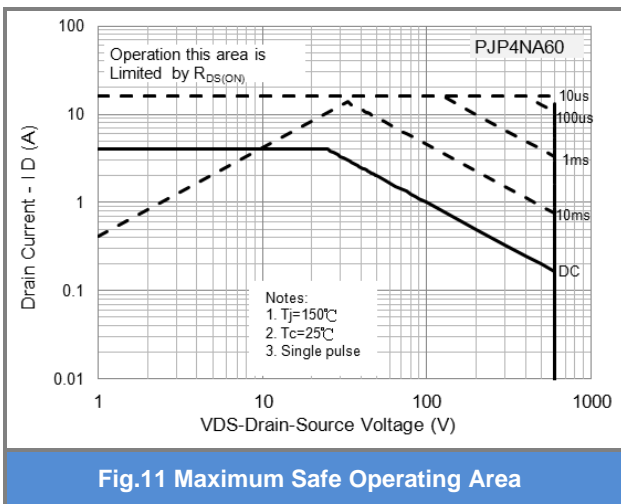
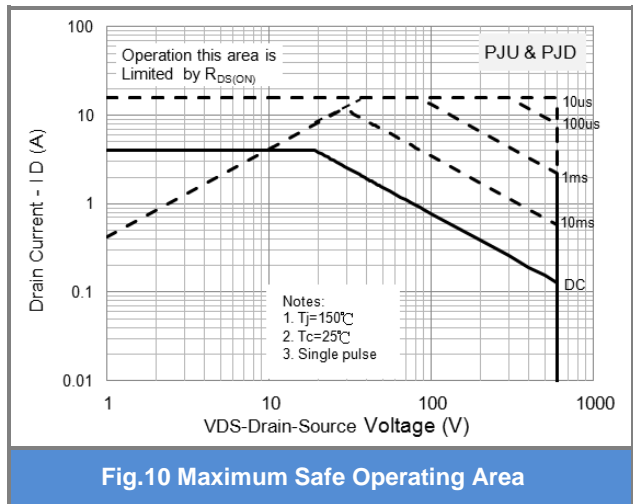
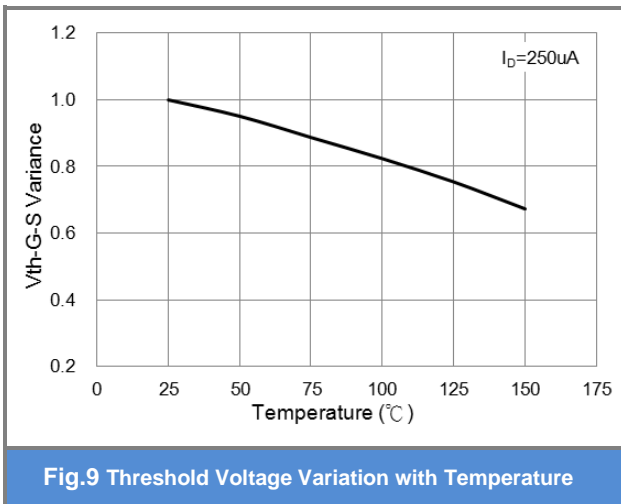
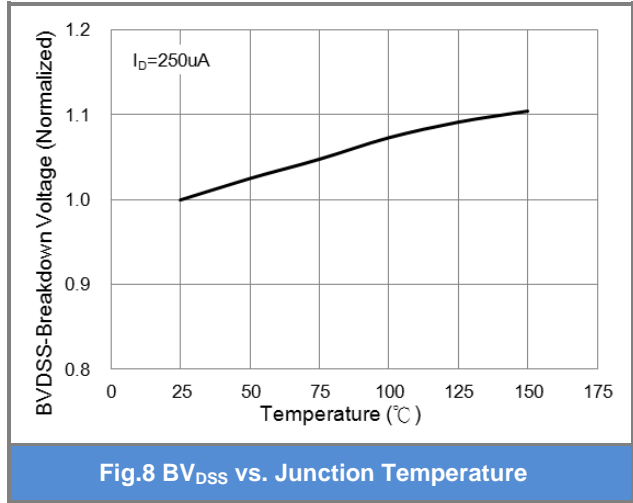
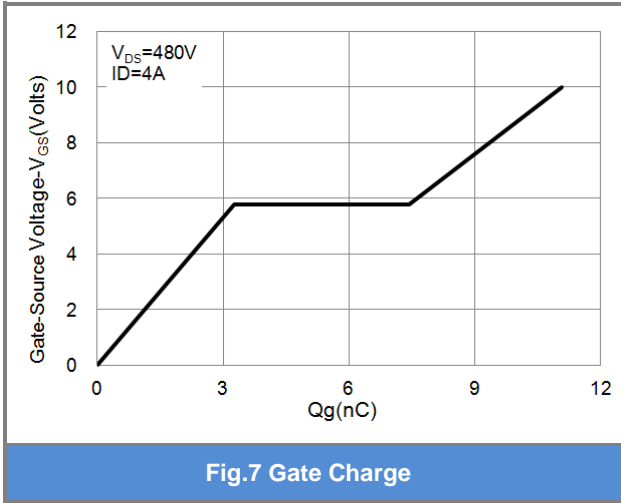

Fig.6 Source-Drain Diode Forward Voltage



# PJU4NA60 / PJD4NA60 / PJP4NA60 / PJF4NA60

## TYPICAL CHARACTERISTIC CURVES





# PJU4NA60 / PJD4NA60 / PJP4NA60 / PJF4NA60

## TYPICAL CHARACTERISTIC CURVES

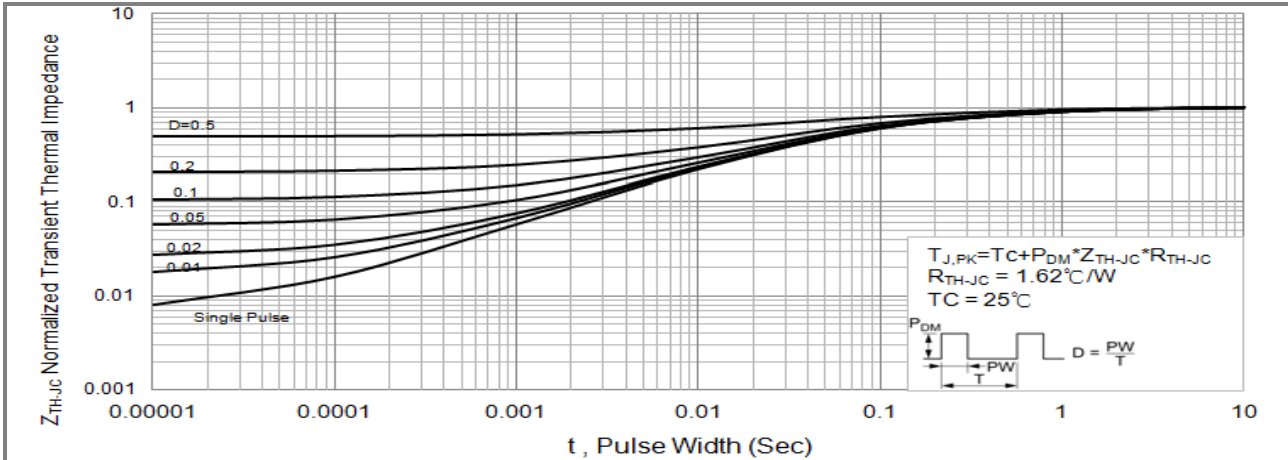

Fig.13 PJU/PJD Normalized Transient Thermal Impedance vs. Pulse Width

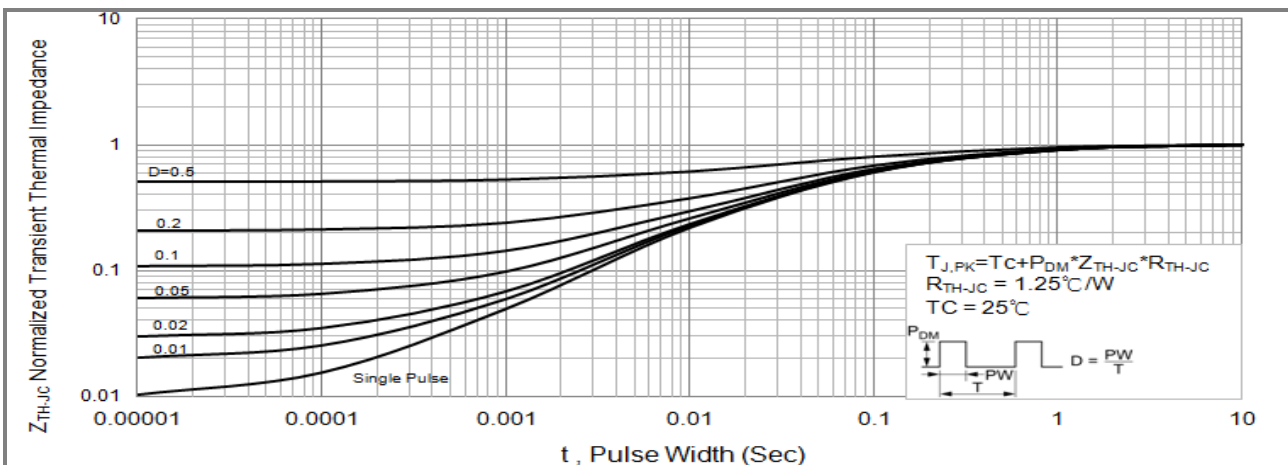

Fig.14 PJP4NA60 Normalized Transient Thermal Impedance vs. Pulse Width

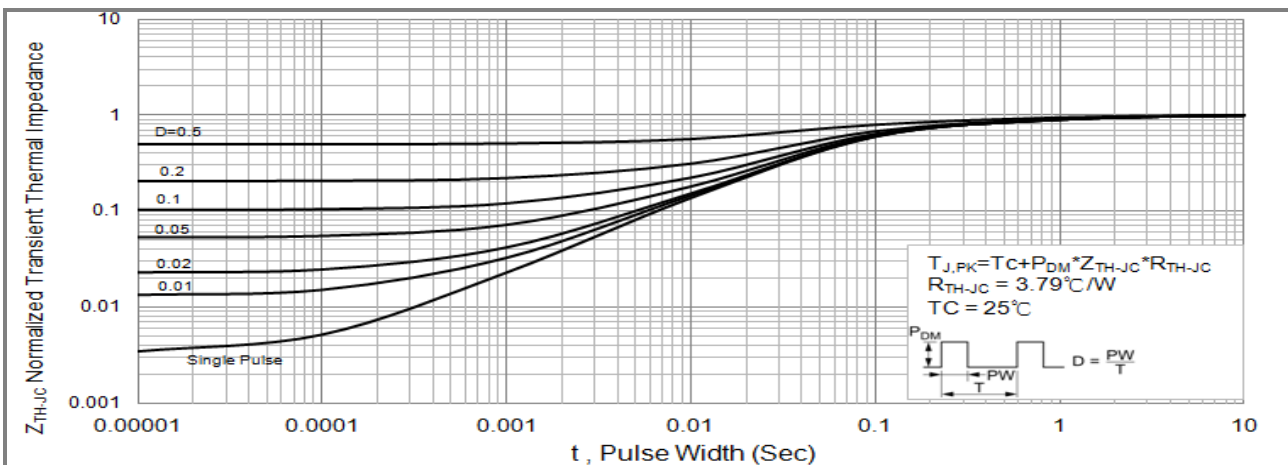
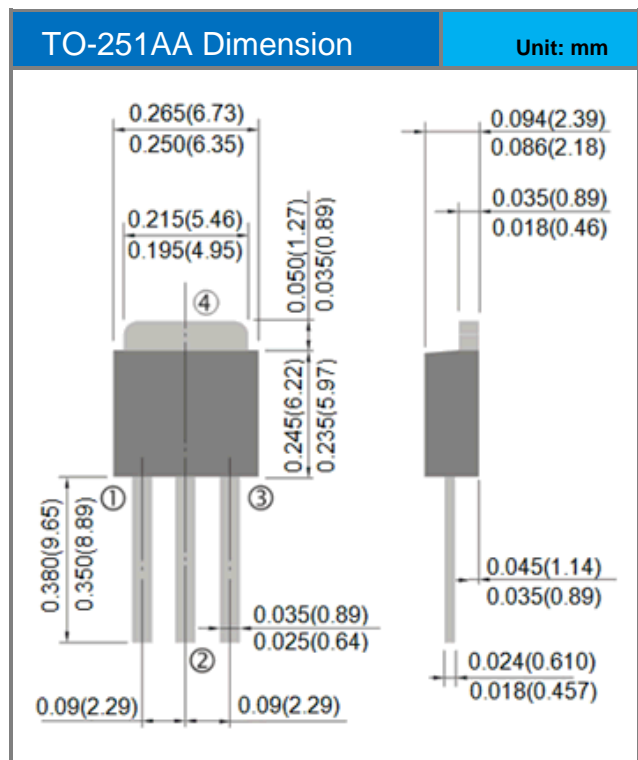
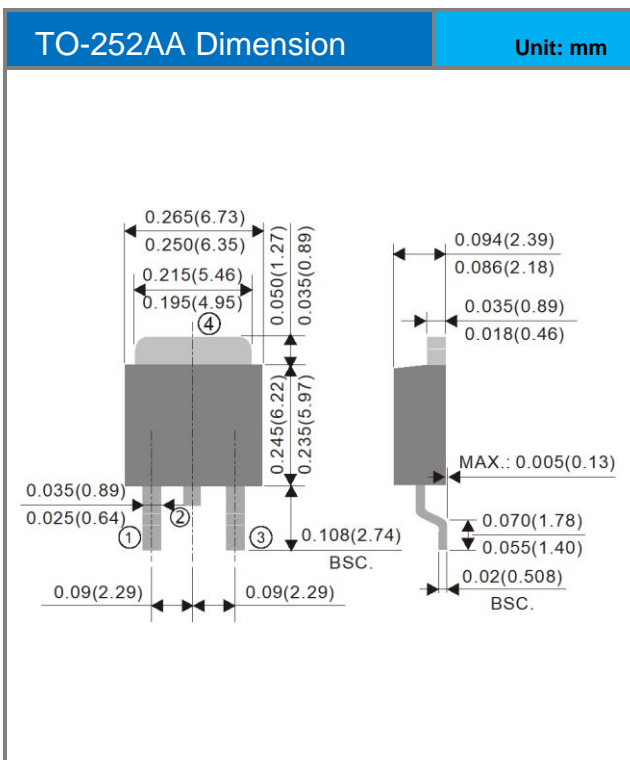
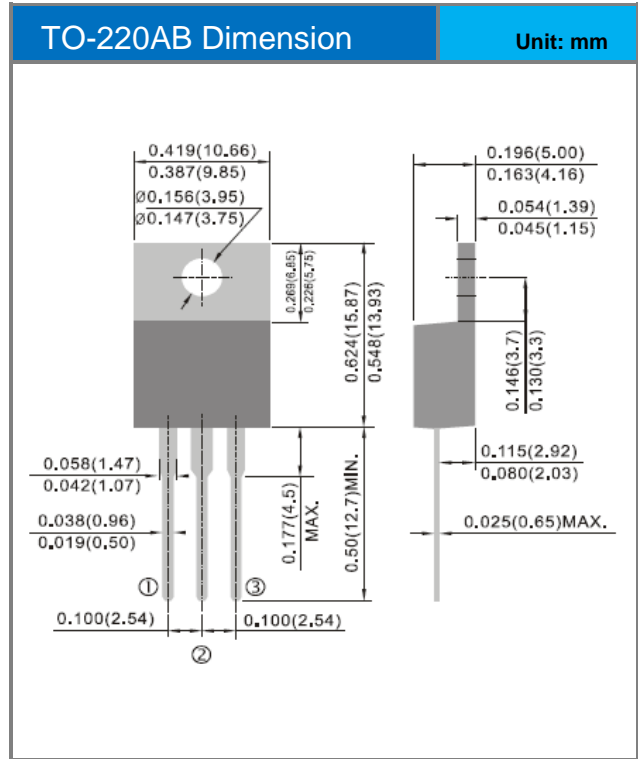
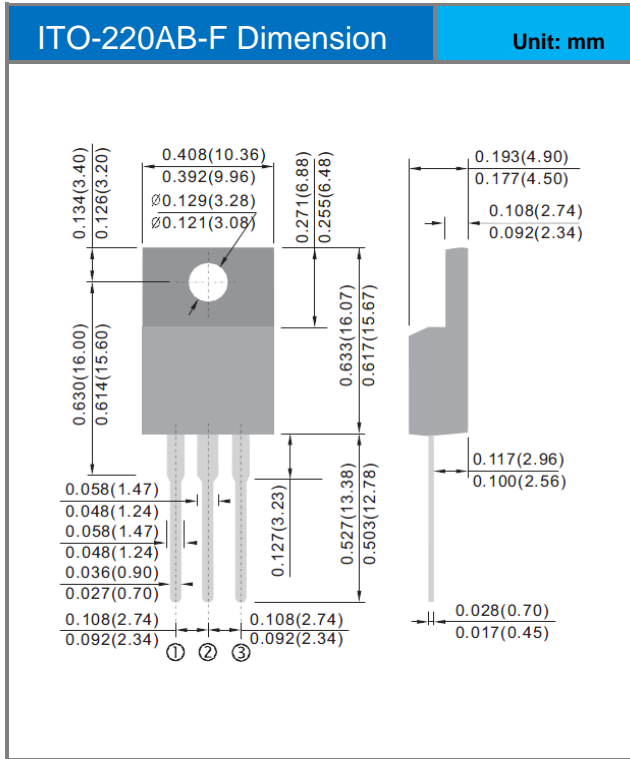

Fig.15 PJF4NA60 Normalized Transient Thermal Impedance vs. Pulse Width



# PJU4NA60 / PJD4NA60 / PJP4NA60 / PJF4NA60

## Packaging Information





## PJU4NA60 / PJD4NA60 / PJP4NA60 / PJF4NA60

### PART NO PACKING CODE VERSION

| Part No Packing Code | Package Type | Packing type        | Marking | Version      |
|----------------------|--------------|---------------------|---------|--------------|
| PJU4NA60_T0_00001    | TO-251AA     | 80pcs / Tube        | U4NA60  | Halogen free |
| PJD4NA60_L2_00001    | TO-252AA     | 3,000pcs / 13" reel | D4NA60  | Halogen free |
| PJP4NA60_T0_00001    | TO-220AB     | 50pcs / Tube        | P4NA60  | Halogen free |
| PJF4NA60_T0_00001    | ITO-220AB-F  | 50pcs / Tube        | F4NA60  | Halogen free |