

**PLED Ultra Low Holding Current Series**



**Description**

This PLED ultra-low holding current series exhibits a low holding current parameter that makes it compatible with LED lighting strings. The series provide a switching electronic characteristics for an fluorescent tube replacement by an LED string. It helps to make the Fluorescent ballast and LED string compatible with each other. This ensures the ballast will be able to activate the LED string; especially for those ballast that need a high voltage output detection during ignition. The PLED ultra-low  $I_H$  makes the LED driver widely used in the output of fluorescent tubes a compatible direct replacement for indoor and outdoor LED lighting strings.

**Schematic Symbol**

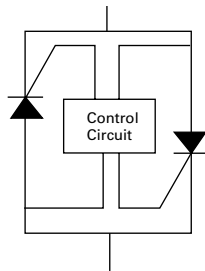

**Features & Benefits**

- Fast switching
- Automatically resets after power cycle
- Available in low profile, Standard DO-214AA packages
- IEC-61000-4-2 ESD 30kV (Air), 30kV (Contact)
- ESD protection of data lines in accordance with IEC 61000-4-2 (IEC 801-2)
- Compatible with industrial lighting environments
- RoHS compliant and halogen-free

**Electrical Characteristics** (All parameters are measured at  $T_A=25^\circ\text{C}$  unless otherwise noted)

| Part Number           | Marking | $V_{BR}$<br>Breakdown |     | $V_{DRM}$ | $I_H$ | $I_S$ | $V_T @ I_T = 1$<br>Amp | $I_o^1$ | Critical rate of<br>rise dV/dt |
|-----------------------|---------|-----------------------|-----|-----------|-------|-------|------------------------|---------|--------------------------------|
|                       |         | Volts                 |     | Volts     | mAmps | mAmps | Volts                  | Amps    | Volts                          |
|                       |         | Min                   | Max | Min       | Max   | Max   | Max                    | Max     | Min                            |
| PLED64S               | PL64    | 58                    | 71  | 56        | 21    | 800   | 2                      | 1.0     | 250V/ $\mu\text{s}$            |
| PLED70S               | PL70    | 65                    | 81  | 63        | 21    | 800   | 2                      | 1.0     | 250V/ $\mu\text{s}$            |
| PLED90S               | PL90    | 75                    | 90  | 73        | 21    | 800   | 2                      | 1.0     | 250V/ $\mu\text{s}$            |
| PLED110S              | PL110   | 90                    | 120 | 87        | 21    | 800   | 2                      | 1.0     | 250V/ $\mu\text{s}$            |
| PLED130S              | PL130   | 120                   | 149 | 116       | 21    | 800   | 2                      | 1.0     | 250V/ $\mu\text{s}$            |
| PLED150S              | PL150   | 136                   | 167 | 132       | 21    | 800   | 2                      | 1.0     | 250V/ $\mu\text{s}$            |
| PLED180S              | PL180   | 170                   | 203 | 165       | 21    | 800   | 2                      | 1.0     | 250V/ $\mu\text{s}$            |
| PLED230S              | PL230   | 190                   | 240 | 184       | 21    | 800   | 2                      | 1.0     | 250V/ $\mu\text{s}$            |
| PLED260S              | PL260   | 220                   | 274 | 213       | 21    | 800   | 2                      | 1.0     | 250V/ $\mu\text{s}$            |
| PLED310S              | PL310   | 275                   | 330 | 267       | 21    | 800   | 2                      | 1.0     | 250V/ $\mu\text{s}$            |
| PLED350S              | PL350   | 320                   | 380 | 310       | 21    | 800   | 2                      | 1.0     | 250V/ $\mu\text{s}$            |
| PLED380S              | PL380   | 350                   | 430 | 340       | 21    | 800   | 2                      | 1.0     | 250V/ $\mu\text{s}$            |
| PLED450S <sup>2</sup> | PL450   | 410                   | 495 | 397       | 21    | 800   | 2                      | 1.0     | 250V/ $\mu\text{s}$            |
| PLED480S <sup>2</sup> | PL480   | 450                   | 600 | 436       | 21    | 800   | 2                      | 1.0     | 250V/ $\mu\text{s}$            |

note:

1.  $I_o$  - Operation current tested @ aluminum boards, ambient temp 85°C
2. PLED450S and PLED480S are still under developed, please contact local sales representative for further information

### Thermal Considerations

| Package   | Symbol          | Parameter                               | Value                              | Unit |
|---|-----------------|---|------------------------------------|------|
| <br>DO-214 | $T_J$           | Operating Junction Temperature Range    | -40 to +125                        | °C   |
|   | $T_S$           | Storage Temperature Range               | -65 to +150                        | °C   |
|   | $R_{\theta JA}$ | Thermal Resistance: Junction to Ambient | 90 <sup>1</sup><br>40 <sup>2</sup> | °C/W |

Notes:

- 1) Standard FR-4 PCB with Copper Pads (Recommended Size)
- 2) Aluminum PCB

Thickness: 1.6mm  
 Grade: 1-2 W/mK Thermal Conductivity  
 Trace thickness: 2 oz  
 Insulation layer thickness: 215 um  
 Solder Pad Dimensions: 2.0mm x 2.8mm (Recommended Size)

### V-I Characteristics

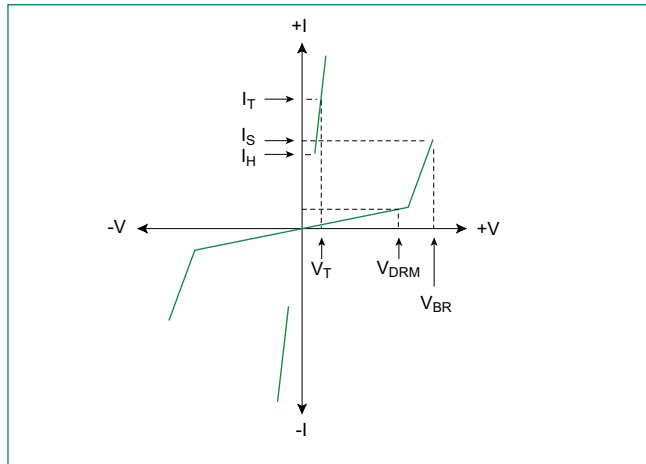

### $V_{BR}$ vs. Junction Temperature

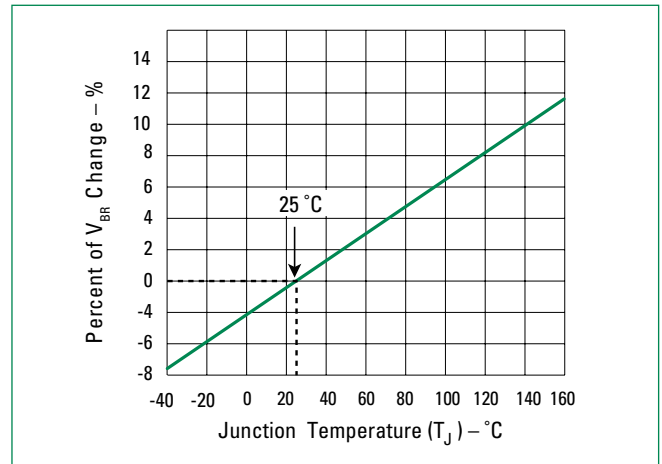

### Normalized DC Holding Current vs. Case Temperature

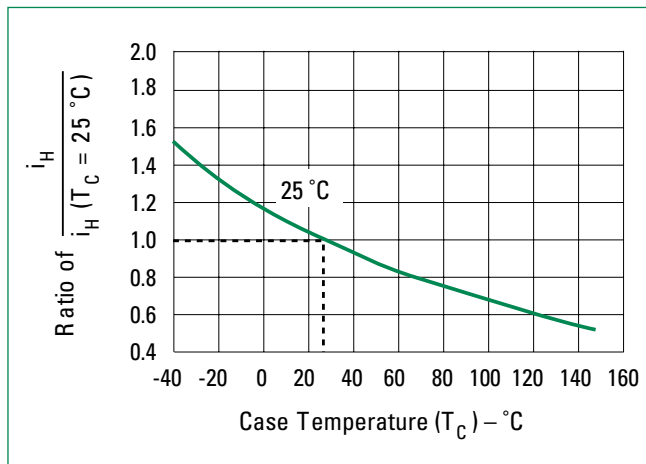

**Soldering Parameters**

|  |                                    |                         |
|--|------------------------------------|-------------------------|
| Reflow Condition                                       |                                    | Pb – Free assembly      |
| Pre Heat   | - Temperature Min ( $T_{s(min)}$ ) | 150°C                   |
|  | - Temperature Max ( $T_{s(max)}$ ) | 200°C                   |
|  | - Time (min to max) ( $t_s$ )      | 60 – 180 secs           |
| Average ramp up rate (Liquidus Temp ( $T_L$ ) to peak) |                                    | 3°C/second max          |
| $T_{s(max)}$ to $T_L$ - Ramp-up Rate                   |                                    | 3°C/second max          |
| Reflow   | - Temperature ( $T_L$ ) (Liquidus) | 217°C                   |
|  | - Temperature ( $t_L$ )            | 60 – 150 seconds        |
| Peak Temperature ( $T_p$ )                             |                                    | 260 <sup>+0/-5</sup> °C |
| Time within 5°C of actual peak Temperature ( $t_p$ )   |                                    | 30 seconds              |
| Ramp-down Rate   |                                    | 6°C/second max          |
| Time 25°C to peak Temperature ( $T_p$ )                |                                    | 8 minutes max           |
| Do not exceed  |                                    | 260°C                   |

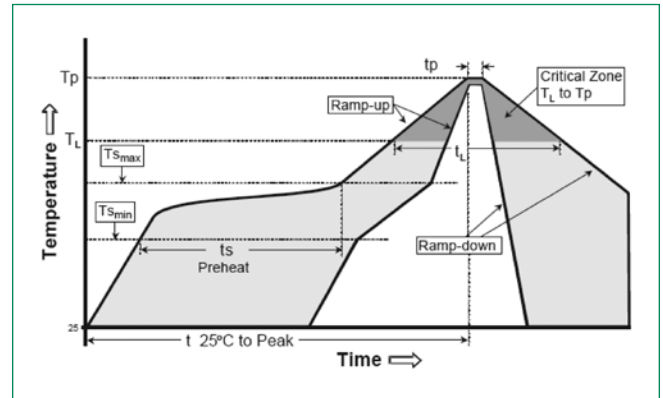

**Physical Specifications**

|                          |   |
|--------------------------|---|
| <b>Terminal Material</b> | Copper Alloy  |
| <b>Terminal Finish</b>   | 100% Matte Tin Plated                                   |
| <b>Body Material</b>     | UL Recognized compound meeting flammability rating V-0. |

**Environmental Specifications**

|  |  |
|--|--|
| <b>High Temperature Voltage Blocking</b> | MIL-STD-750: Method 1040, Condition A<br>80% min $V_{DRM}$ (VAC-peak), 125°C, 1008 hours   |
| <b>Temperature Cycling</b>               | MIL-STD-750: Method 1051, -55°C to 150°C,<br>15-minute dwell, 1000 cycles                  |
| <b>Biased Temperature &amp; Humidity</b> | EIA/JEDEC: JESD22-A101<br>52VDC, 85°C, 85%RH, 1008 hours                                   |
| <b>Thermal Shock</b>                     | MIL-STD-750: Method 1056<br>0°C to 100°C, 5-minute dwell,<br>10-second transfer, 10 cycles |
| <b>Resistance to Solder Heat</b>         | MIL-STD-750: Method 2031<br>260°C, 10 seconds  |
| <b>Moisture Sensitivity Level</b>        | 85%RH, +85°C, 168 hours, 3 reflow cycles<br>(+260°C peak). JEDEC-J-STD-020, Level 1        |

**Dimensions - DO-214 AA Package**

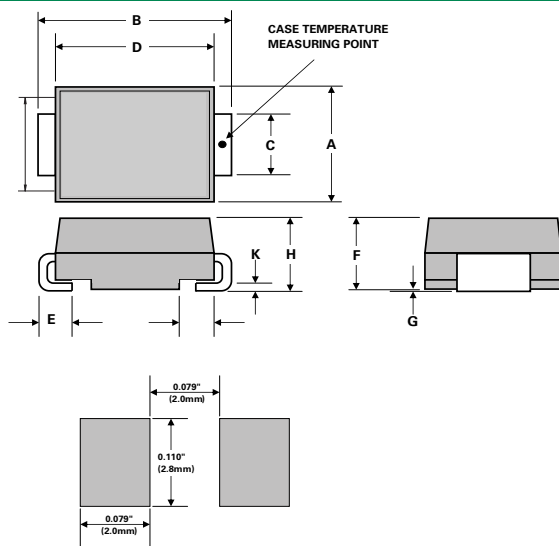

Recommended solder pad layout  
(Reference Only)

| Dimensions | Inches |       | Millimeters |      |
|------------|--------|-------|-------------|------|
|            | Min    | Max   | Min         | Max  |
| A          | 0.130  | 0.156 | 3.30        | 3.95 |
| B          | 0.201  | 0.220 | 5.10        | 5.60 |
| C          | 0.077  | 0.087 | 1.95        | 2.20 |
| D          | 0.159  | 0.181 | 4.05        | 4.60 |
| E          | 0.030  | 0.063 | 0.75        | 1.60 |
| F          | 0.075  | 0.096 | 1.90        | 2.45 |
| G          | 0.002  | 0.008 | 0.05        | 0.20 |
| H          | 0.077  | 0.104 | 1.95        | 2.65 |
| K          | 0.006  | 0.016 | 0.15        | 0.41 |