



**San Ace**  
COOLING SYSTEMS



**SANMOTION**  
SERVO SYSTEMS

# PRODUCT INFORMATION

Ver. 3



**SANUPS**  
POWER SYSTEMS

**SANYO DENKI**

# SANYO DENKI Develops Products That Contribute to the Happiness of All People.



## Contents

Product Overview	.....p. 3
<b>Features</b>	
Cooling Systems	.....p. 6
Power Systems	.....p. 14
Servo Systems	.....p. 22
<b>Product Lineup</b>	
Cooling Systems Products	...p. 30
Power Systems Products	...p. 36
Servo Systems Products	...p. 46

# San Ace

## Cooling Systems Products

Many of the devices that are essential to today's society, such as IT infrastructure like servers and communication equipment, medical inspection equipment, and control devices used in factories, require heat control solutions. Our San Ace Cooling Systems products are used to cool these devices to ensure their stable operation. SANYO DENKI's cooling fans are characterized by best-in-class performance, quality, and reliability, and they contribute to improving the performance and reliability of our customers' equipment.



# SANUPS

## Power Systems Products

The electronic devices and communication networks indispensable for our daily lives cannot be maintained without a stable power supply. Our SANUPS Power Systems products, including uninterruptible power supplies (UPS) and renewable energy inverters, supply high-quality and stable power to customers' equipment in the event of unexpected power outages as well as in normal situations. They can be used for disaster management and business continuity planning purposes as well.



# SANMOTION

## Servo Systems Products

Our motors and the amplifiers that drive them are required for "motion" of devices such as machine tools and industrial robots in factories, and medical equipment. Our products are best suited to applications that require accurate positioning and high performance. Our SANMOTION Servo Systems products improve the productivity of customers' equipment with high-precision and high-speed drive, as well as flexible customization.



# SANYO DENKI Products Making Contributions in a Wide Range of Industries

Our products are the unsung heroes of society that work behind the scenes to support our lives. They are used all over the world, from convenience stores to factories, and contribute to people.



## In hospitals

Our products are found in a variety of equipment including medical inspection and analysis equipment.

### Dental X-rays

San Ace Fans

Cooling control boards

SANUPS UPS

Power backup in case of power outages

SANMOTION Servo Systems

Driving equipment while controlling speed and direction

### Blood analyzers

San Ace Fans

Cooling control boards

SANUPS UPS

Power backup of inspection equipment

SANMOTION Servo Systems

Rotating axis of specimen holders



## In food factories

In food and semiconductor manufacturing factories, SANYO DENKI products are used to supply stable power to various units on automated production lines and the entire factory.

### Air showers

San Ace Fans

Blowing clean air through filters

### Automatic labelers

SANUPS UPS

Power backup of the labeler and data PC in case of power outages

SANMOTION Servo Systems

Driving label tape rolls and conveyor belts



## In convenience stores

Our products are found in store fixtures for heating and cooling goods and equipment for providing convenient services.

### ATM

San Ace Fans

Cooling the housing and paper currency detector

SANUPS UPS

Power backup during power outages

SANMOTION Stepping Systems

Dispensing paper currency, conveying receipts and cards

### POS registers

San Ace Fans

Cooling the CPU and power supply

SANUPS UPS

Power backup of registers and data PCs



## In IT systems

Our products ensure that servers, base stations, and other critical IT systems operate safely through cooling and power backup.

### Servers

San Ace Fans

Cooling the housing and individual units

SANUPS UPS

Long-term power backup of data centers

### 5G base stations

San Ace Fans

Cooling the housing and individual units

SANUPS UPS

Power backup during power outages



## FA

Our products are used in robots, machine tools, and control devices, achieving factory automation (FA).

### Palletizing robots

San Ace Fans

Cooling control boards

SANUPS UPS

Power backup of palletizing robots during outages

SANMOTION Servo Systems

Driving robots while controlling speed and trajectory

### Machine tools

San Ace Fans

Cooling control boards and power supplies

SANUPS Voltage Dip Compensator

For protection from momentary voltage dips

SANMOTION Servo Systems

Workpiece feeding and shaft driving

# Fans That Protect Society with Cooling

In IT equipment and industrial machinery, the importance of measures against heat generation is increasing as components generate more heat and equipment becomes more compact. This is where San Ace Cooling Systems, and fans in particular, come into play. Our high-performance fans contribute to the stability of social infrastructure by powerfully cooling equipment even in limited installation space, and protecting it from heat.



## In telecom and TV fields

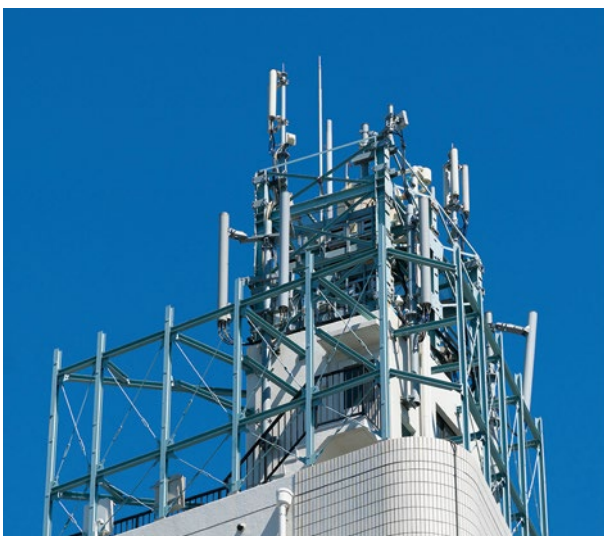

Wireless relay stations located on the rooftops of buildings transmit radio waves for mobile phones and TV broadcasts. For outdoor use, San Ace fans which feature high water resistance and long service lives are used.

## In IT and advertising fields

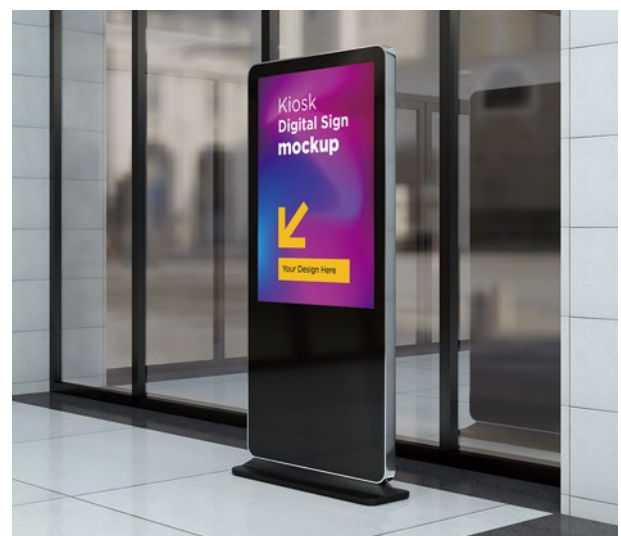

In recent years, digital signage has become widely installed in restaurants and public facilities. Energy-saving and low-noise fans are used.

# Why they choose San Ace?

Point

1

## High-reliability & high-performance design



San Ace was introduced in 1965 as the first fan produced domestically in Japan, and has continued to be developed while maintaining high reliability. We design and develop highly reliable and high-performance fans at our two Technology Centers in Ueda City, Nagano Prefecture, and Subic Special Economic Zone in the Republic of the Philippines.

All of our DC fans are equipped with ball bearings to stabilize the load during rotation and rotor covers to fix the magnets and impellers for high reliability and long life.

Point

2

## High-quality production and manufacturing



In terms of production technology, we are also constantly developing technologies to provide high-quality products. For example, we manufacture our own original precision molds to achieve high-quality manufacturing in a short period of time. In addition, we use precise technology in our production procedures to correct balance and inspect all fans, which greatly affects their service life and reliability.

Point

3

## Various proposals to satisfy customers' needs

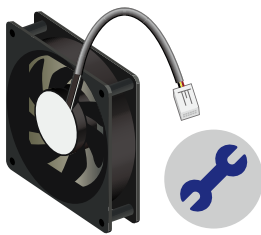

We have a lineup of many unique products to solve our customers' problems, including fans with excellent environmental resistance such as Long Life Fans and Splash Proof Fans, and ACDC Fans that are driven by DC power with an AC input.

We also specialize in customizing existing fans with connectors and tubing to improve their durability for the environments in which they will be used. We have a variety of controllers to control fan speed and use them under optimal operating conditions, as well as measuring instruments to select the best fan for the equipment.

Point

4

## Short Lead Time Service



A Short Lead Time Service is available for the prompt delivery of our products. Please contact your point of sale for details.

# A variety of ways to use fans

## Cooling

There are many ways to provide cooling.

San Ace offers a rich lineup available, so you can find a model that fits your equipment.

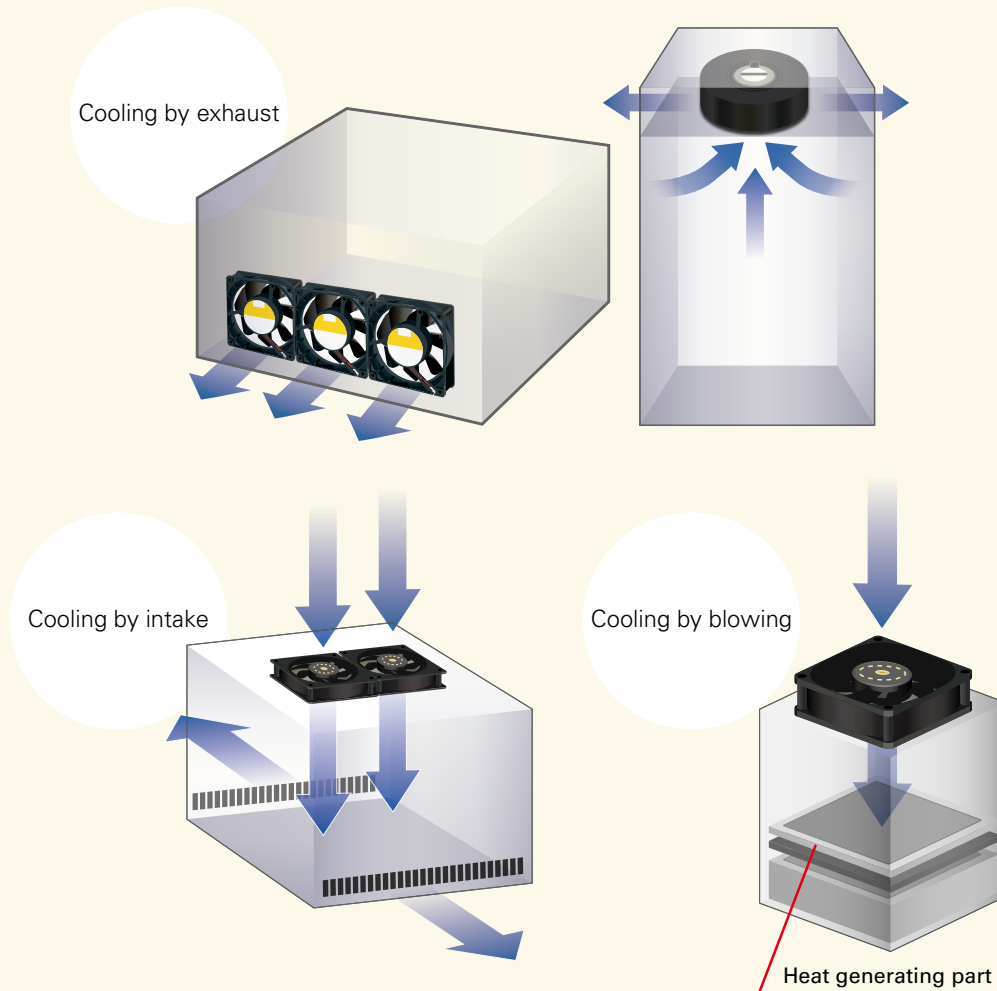

Make  
selection  
easy

You can narrow down fans by size and airflow with the **Advanced Search** on our Product Site.

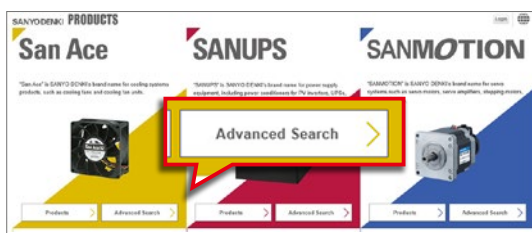

<https://products.sanyodenki.com/en/sanace/search/>





# Not just cooling

## Air supply and circulation

They can be used for a variety of applications that require wind.



Air circulation  
(Inside showcases, in plant factories, etc.)

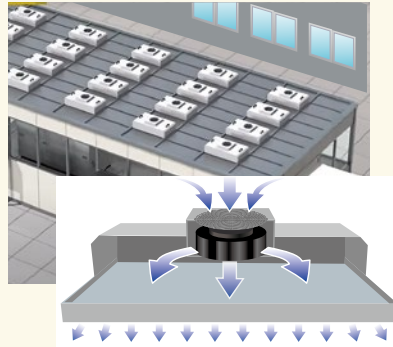

Sending air through filters  
(in the ceilings of factories)

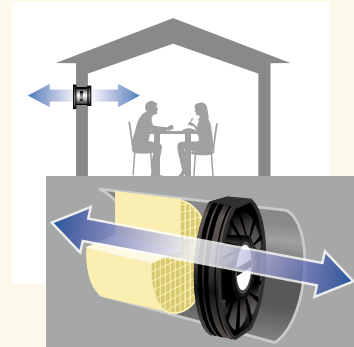

Indoor ventilation

## Spraying and suction

Suitable fans can be selected to meet the required airflow.

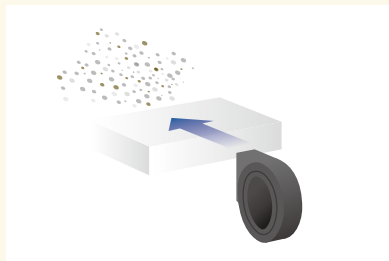

Contaminant removal  
(Production line finishing and forming processes)

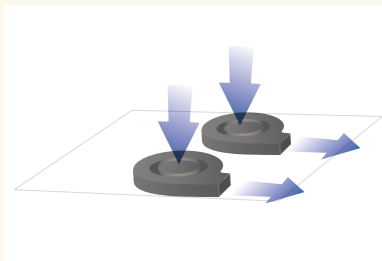

Holding paper by air suction  
(Printers, copiers, etc.)

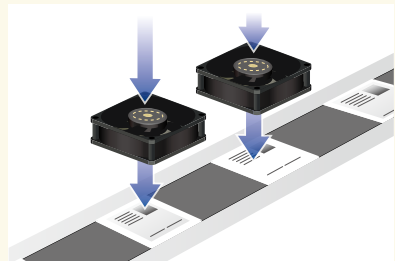

Using blasts of air for drying  
(Food processing machines, production lines, etc.)

## The Airflow Tester portable measurement device makes selection easy

To cool equipment efficiently while reducing the power consumption and noise of the fan, it is important to measure the system impedance and operating airflow of the equipment to select the optimal fan. The Airflow Tester is a portable, double-chamber measurement device weighing only about 6 kg, which allows the easy and accurate selection of the optimal fan for a device.

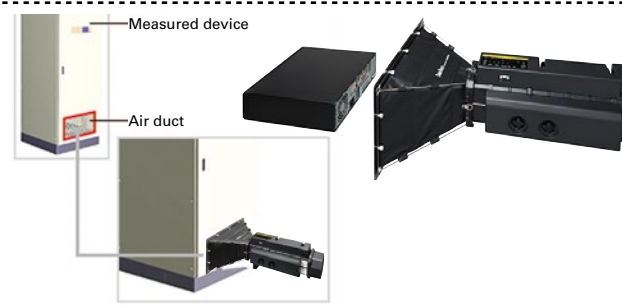

## Problem

How to choose between axial fans, blowers, centrifugal fans, and other types of fans?

## Solved!

Choose from a wide range of products to meet different needs

### Axial Fan

Our rich lineup includes products with features such as high airflow and low noise. They are suitable for a variety of applications such as air blowing, ventilation, and local cooling.

#### Varied lineup



DC Fan



Oil Proof Fan



ACDC Fan



Wide Temperature Range Fan



AC Fan



Splash Proof Fan



G Proof Fan



### Counter Rotating Fan

The two impellers concentrate the wind flow into a straight direction. They are ideal for dense equipment that requires high airflow.

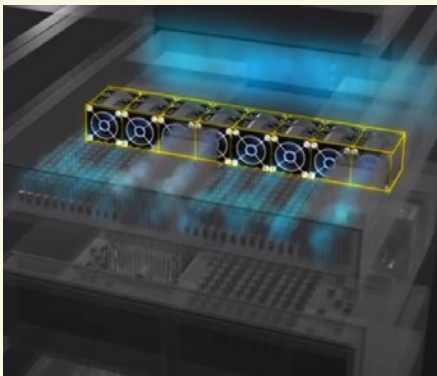

Example of use inside a server

Devices such as 1U servers have a very dense interior. This often requires multiple fans, but power consumption becomes a problem. Counter Rotating Fans provide efficient cooling and reduce power consumption.

#### Counter Rotating Fan mechanism

When two fans are used in series, the air will spread out like the wind from a household fan. A Counter Rotating Fan has two impellers that rotate in opposite directions to improve the flow of air and deliver wind in a straight direction.

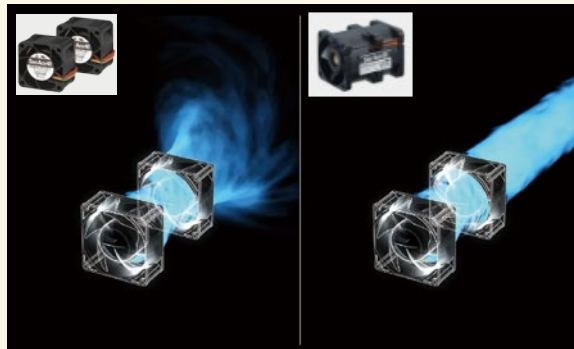

**Reversible Flow Fan**

A fan that can switch the airflow direction. Ideal for applications where changing the wind direction is needed.

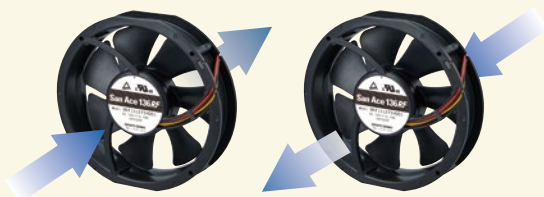

In some cases, such as in house ventilation systems, multiple fans are used to blow air in both directions. For these cases, our Reversible Flow Fans can reduce the number of fans used, leading to cost reductions and space savings.

They are simple to control, and airflow and static pressure are almost the same in either direction.

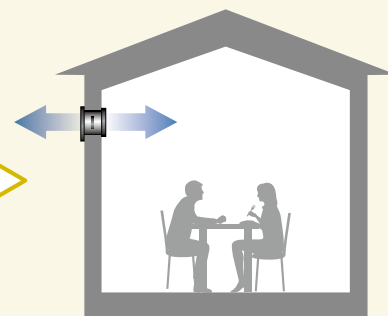

**Centrifugal Fan**

Since air is expelled in a 360° direction, exhaust vents can be designed freely. It is ideal for applications with large spaces and multiple heating elements.



Centrifugal Fans can change the flow of air by 90° and are most suitable for use when installing an exhaust vent on the side of equipment.

Applications:  
ICT equipment, servers, storage, heat exchangers, air purifier systems

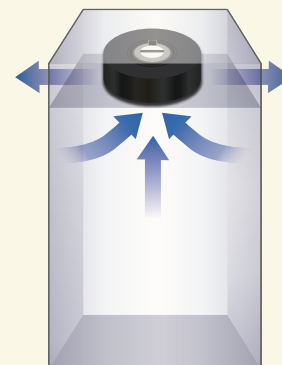

**Blower**

Can expel air at a right angle. High static pressure makes it ideal for spot cooling and applications where air does not flow easily.

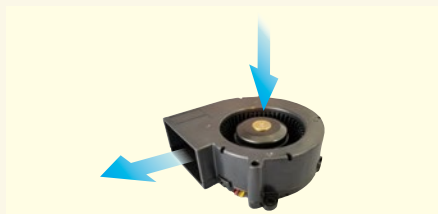

It is suitable for spot cooling and applications where air flows poorly because it can discharge air in a straight direction with high static pressure.

In applications like supplying air in ducts where high static pressure is required.

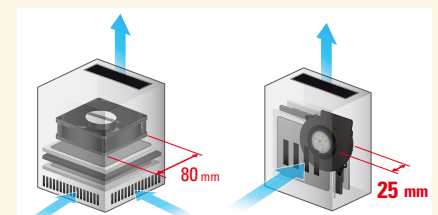
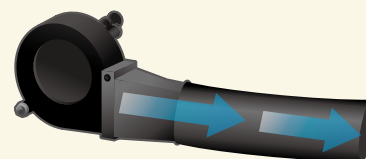

Systems can be designed thinner while providing the same cooling performance.

Applications:  
Servers, storage, mobile communications base stations, applications where air must be blown into a narrow space

## Problem

# Outdoor equipment exposed to rain. Inspection is difficult!

## Solved!

### Splash Proof Fans provide high resistance to dust and water

Equipment installed outdoors such as communications base stations and EV chargers must be waterproof to withstand rain and humidity. Resistance to dust is also important in food factories and other environments where powder is scattered. Splash Proof Fans with up to IP68 water and dust resistance provide peace of mind.

• In addition, Splash Proof Long Life Fans have a 180,000 hour expected life.

**Needs to be replaced three times**

Compared to Splash Proof Fan of equivalent size, maintenance labor time and cost can be reduced.

Splash Proof Fan 9WP0612H401	Expected life: 45,000 hours	Replacement	Expected life: 45,000 hours	Replacement	Expected life: 45,000 hours	Replacement	Expected life: 45,000 hours
Splash Proof Long Life Fan 9WL0612P4H001	Expected life: <b>180,000</b> hours						



## Problem

# Is there a fan that can be used safely in environments with high or low temperatures?

## Solved!

### Wide Temperature Range Fans can be used in a wide temperature range of -40°C to +85°C

Wide Temperature Range Fans are suitable for many applications, from low-temperature refrigerators and freezers to high-temperature lighting equipment.

The fan's expected life is 40,000 hours at an ambient temperature of 85°C. It can contribute to extending the service life of devices.



### Low-temperature Applications

- Freezers
- Wind power generator, EV quick chargers, and devices installed outdoors in cold regions



### High-temperature Applications

- Projectors
- LED lighting
- Inverters
- LCD monitors

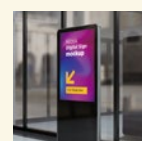

## Problem

Want to control the fan speed efficiently according to the ambient temperature?

### Solved!

### Controller for easy control of fan speed

The San Ace series offers two types of controller to control the speed of PWM fans. A single controller can control the speed of up to four fans.



#### PWM Controller

Fans can be controlled to save energy and achieve low noise without needing to design additional circuit to control the fan speed.



#### San Ace Controller

Monitoring and automatic/manual control of fans and sensors can be performed remotely via wireless or wired LAN. The IoT function allows for efficient fan use.

## Problem

Finger guards might reduce airflow?

### Solved! Our dedicated finger guards do not sacrifice the performance of fans

Depending on the fan's mounting position, finger guards may be required. We offer metal finger guards and resin finger guards made in our own factories with high quality control.

They can be used with confidence, as there is almost no difference in fan performance when installed.

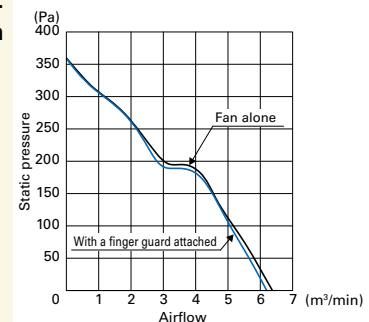
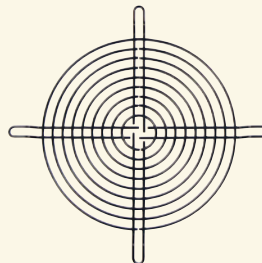

## Problem

Want to keep the air in a large room clean

### Solved! San Ace Clean Air can clean a large space of up to 127 m<sup>2</sup> in 30 minutes

This air purifier has a high airflow of 16.5 m<sup>3</sup>/min and can cover a room of 127 m<sup>2</sup>, which is suitable for large rooms such as offices and conference rooms. Smaller rooms can be cleaned more quickly, with 13.2 m<sup>2</sup> cleaned in less than 4 minutes.

Note: This product is designed for use in Japan only.

#### Average time required\*

Airflow 16.5 m <sup>3</sup> /min	127 m <sup>2</sup> in 30 minutes
	13.2 m <sup>2</sup> in 4 minutes

\* When operating in operation mode 3 (High).  
Calculated by the test method based on the JEMA's JEM 1467 standard (Ceiling height: 2.4 m).



# UPS That Protects Equipment and Society from Power Outages

As digitization and networking have become essential in every part of society, UPSs (uninterruptible power supply) are playing an important role in protecting people's lives by preventing critical data from being lost in power outages. Since our company developed our first UPS in 1961, we have developed and launched a number of highly reliable products. In addition to UPSs, our lineup has power conditioners for photovoltaic generation systems (PV inverters) and a grid management system that enables microgrids, contributing to society through the stable supply of power.



## In data centers



In data centers, UPSs are widely used to protect critical data from power outages. We have a rich lineup of easy-to-use UPSs, such as ones with a highly reliable topology and ones suitable for mounting in server racks.

## In medical clinics



Outage protection is vital for temperature control of specimen and chemical storage equipment. Our rich UPS lineup includes long-term backup models and compact, lightweight models available for safe use in hospitals.

# Why they choose SANUPS?

Point

1

## High reliability



All of our products have their origins in 1927, when we developed a radio power generator. Since then, we have been constantly developing highly reliable products that ensure a stable power supply. Our rich lineup offers UPSs that feature various topologies. We also have a number of UPSs available that provide a fail-safe through a redundant configuration where even if one unit fails unexpectedly, the remaining ones can continue to supply power.

Point

2

## Easy battery replacement



The batteries of our small-capacity UPSs are user-replaceable, reducing maintenance time and costs.

Point

3

## Warranty for peace of mind



UPS batteries are warrantied for one year. Moreover, for some products, the warranty period can be extended to three years by registering the UPS. Within the period, customers can enjoy such benefits as free replacement batteries and battery replacement timing reminders. Note: This benefit is limited to users in Japan.

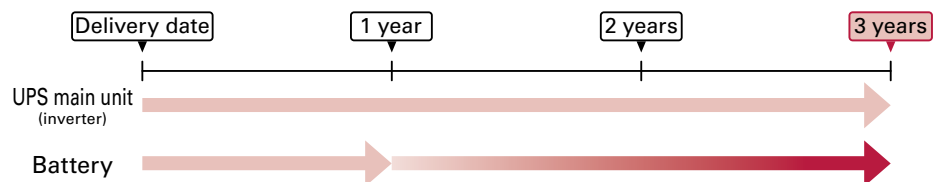

Visit our website for details on applicable models and conditions.  
Find the information page by searching for 'SANYO DENKI UPS registration.'

Point

4

## Maintenance services

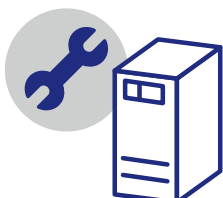

To keep SANUPS products functioning at their best, we offer a variety of maintenance services such as repairs and periodic inspections where we provide replacement and repair parts.

# SANUPS Products Provide Safe Power in These Applications

Protection from momentary outages/dips

UPS

Voltage Dip Compensator

## Power failures occur unexpectedly

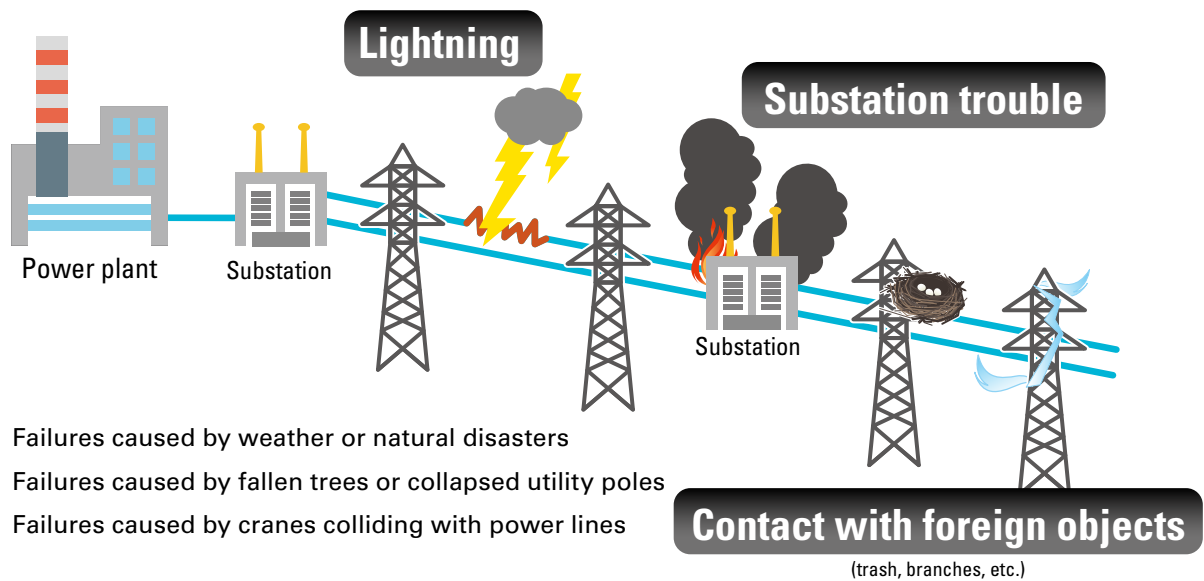

Protection from harmonics

UPS

Voltage Dip Compensator

Our UPSs and voltage dip compensators provide not only protection from power outages and dips, but also protection from harmonics generated by equipment such as plating machines and machine tools. (Excluding standby UPSs)  
Also, there is no need to purchase an active filter separately, contributing to cost reduction.

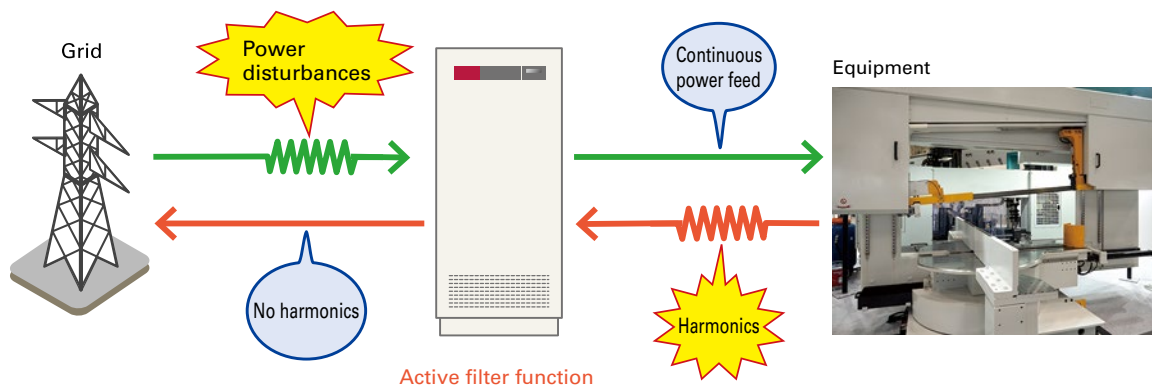



# For BCP purposes

UPS

DEG+UPS

Long-term backup UPSs can be used not only to protect data loss from momentary power failures, but also for BCP (business continuity planning) purposes.

For example, using a model with a 400-minute backup time...

**30 min\***



Using a 1.5 kVA, 400-minute backup model...

1.2 kW	<b>370 min**</b>
120 w	<b>48 hours</b>
84 w	<b>72 hours</b>

For example...

Smartphone charging	Laptop
5 w	25 w

Model no.: S-A11KL152A0400TSN00

\* An optional LAN Interface Card is required to set the battery backup time.  
 \*\* Backup times are calculated with conditions of a 25°C ambient temperature, using new, fully charged batteries.

Also, when an emergency diesel engine generator (DEG) is combined with a UPS...

At normal times high-quality power is supplied from the UPS, and in the event of a momentary voltage dip or outage, power is supplied from the battery. In the event of a prolonged power outage, the UPS switches to the generator without interruption, maintaining a stable power supply.

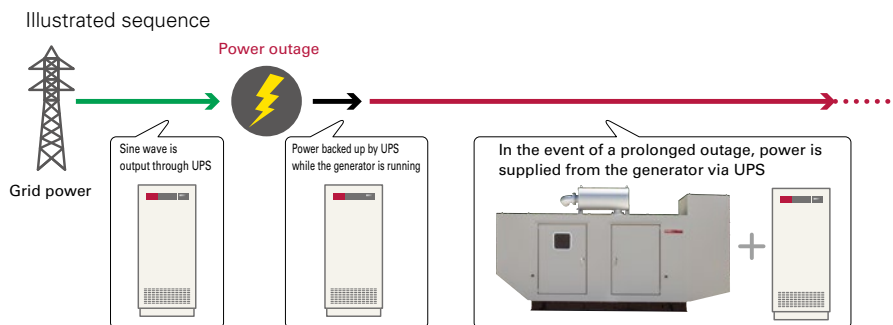

We also offer mobile power generation vehicles that can provide power whenever and wherever necessary. It may be difficult to install generators in multiple locations due to cost, space, and maintenance problems. A mobile power generation vehicle, however, can move to where it is needed.



# What is a UPS?

A UPS (uninterruptible power supply) ensures that continuous power is supplied to a load even in the event of a power grid failure. Typically, a UPS consists of a rectifier that converts AC to DC power, an inverter that converts DC to AC power, and storage batteries. During a power failure, the inverter converts the DC power stored in the battery into AC power to power the load.

## Without a UPS...

### Power failure



- Electrical equipment stops abnormally
- Requires a long amount of time to restart electrical equipment and systems

## With a UPS...

### Power failure

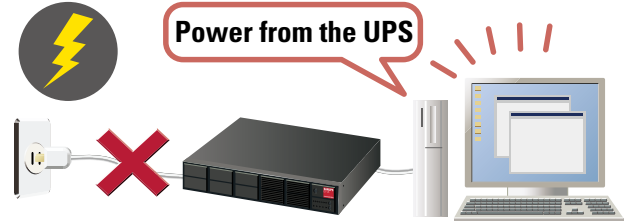

Our lineup has UPSs with the following topologies available to allow you to select the best UPS for your application.

## ■ Topology

### Passive Standby

This topology offers the lowest power conversion loss. Since there will be a momentary interruption, this UPS is suitable for applications such as surveillance cameras where a momentary interruption is not a problem.

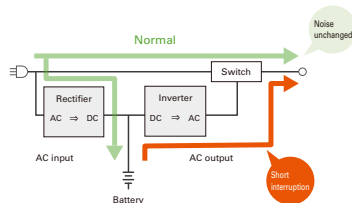

### Hybrid

UPSs featuring this topology automatically select the optimal mode of operation for any given input power conditions. They provide high-quality power and low power losses, and are suitable for elevators and the control part of machine tools.

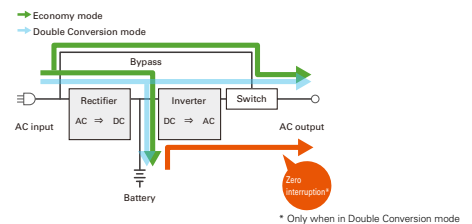

### Double Conversion Online

This topology continuously provides the best-quality power through the inverter. It also offers zero transfer time during outages. These UPSs are ideal for critical applications such as base stations and communication servers.

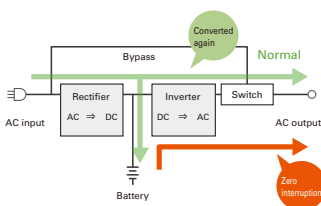

### Parallel Processing

This topology ensures that a bi-directional inverter corrects the power factor and absorbs noise, improving the quality of input power. It also offers zero transfer time during outages. These UPSs feature a high efficiency, and are suitable for industrial production equipment.

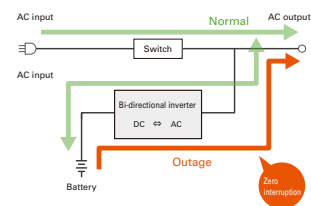

## ■ Installation method

### Free-standing

Installation on the floor



### Rack-mount

Suitable for 19-inch rack servers

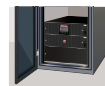

### Outdoors

For outdoor installation, UPSs with IP65-rated water and dust protection are also available.

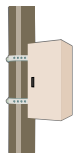

## ■ Input voltage

In addition to 100 V and 200 V class models, we also have 400 V class models available in the lineup for use in factories and outside Japan. UPSs with a wide input range are also available.

You can narrow down UPSs with the **Advanced Search** on our Product Site.

<https://products.sanyodenki.com/en/sanups/search/ups/>



# Always Use Clean Power

— Situations where power products are useful —

## Problem

A UPS that can withstand the large startup current of FA equipment?

## Solved!

Parallel processing UPSs are best suited to production equipment!

Equipment that has a motor experiences a large inrush current at startup. Our parallel processing UPSs feature a high overload capability of 800%, so you can focus on the rated capacity when selecting UPSs without worrying about startup currents. With no need to introduce a large-capacity UPS for the startup current, space saving can be achieved.

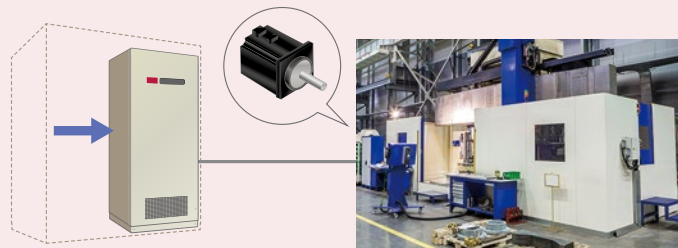

## Problem

Need a power backup with the highest reliability for a critical system?

## Solved!

Increased reliability with parallel redundant operation

By configuring power redundancy, highly reliable double conversion online UPSs can be made even more prepared for power problems.

- With extra capacity, a parallel redundant configuration is possible.
- Provides multiple layers of power protection for critical equipment.

Parallel redundant operation illustrated with A11N (figure on the right)

In an N+1 configuration, the UPS provides a fail-safe protection; in the event that one UPS unit fails, the remaining units can continue to provide power.

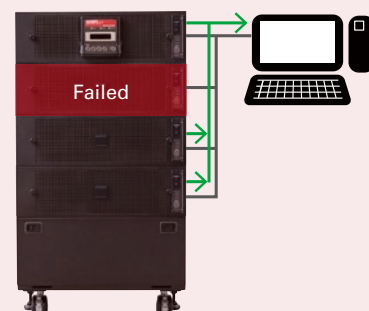

## Problem

Need a long-term power backup for emergency management, but there's no space for generators!

## Solved!

UPS with lithium-ion batteries can provide a long-term backup, and can be used for BCP purposes

UPSs with lithium-ion batteries can be used for protection from momentary dips at normal times, and also as emergency power in the event of a prolonged power outage. Unlike generators, there is no exhaust gas emission. Also, they operate quietly.

Lithium-ion battery...

Provides a longer backup time than lead-acid batteries, and does not require replacement for 10 years.

Lead-acid battery...

Is a standard storage battery that is used in many of our UPSs, and has a life expectancy of 5 years. (Depends on the product)

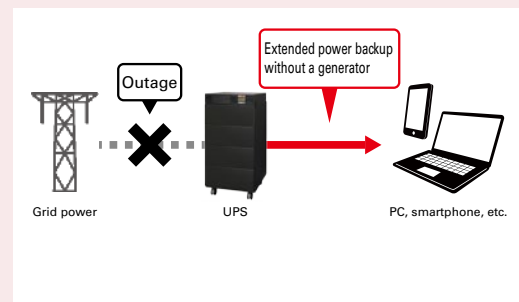

## Problem

Need a way to manage many UPSs efficiently?

## Solved!

A wide range of networking options for central management of multiple UPSs

By combining a LAN interface card and management software for monitoring and managing multiple UPSs, your system can be managed centrally and efficiently. LAN Interface Card models with Modbus, a communication standard widely used in industrial equipment, are also available.

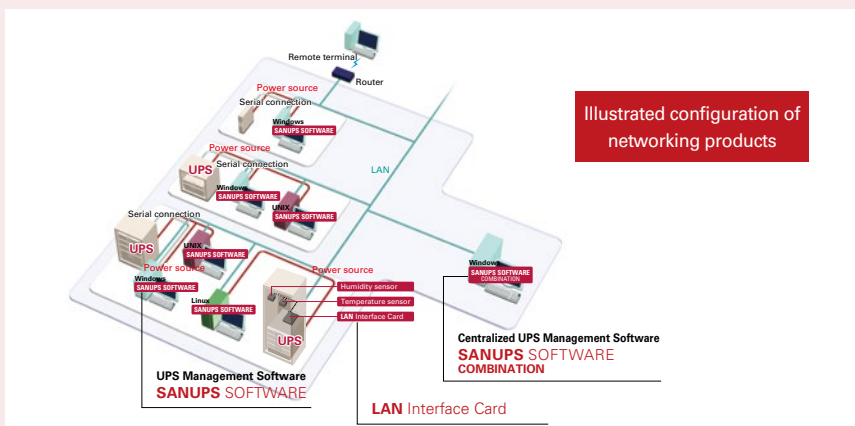

LAN Interface Card

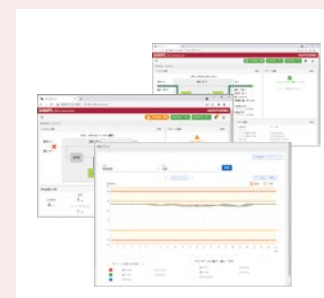

UPS Management Software SANUPS SOFTWARE

## Problem

Want to make good use of renewable energy?

## Solved!

With a power conditioner and grid management system, fluctuating renewable energy can be converted into stable power

Power conditioners (renewable energy inverters) convert the power generated from renewable energy, such as photovoltaic, wind, and hydro power generations, into a usable form of power.

With isolated operation capability, they can continue supplying power during times of emergency

We also have grid management devices available that control the power flow of systems that include distributed power sources, storage batteries, and hybrid type power conditioners that combine solar cells and storage batteries.

These devices enable efficient operation of such systems by efficiently using the power from renewable energy and storage batteries, contributing to BCP purposes.

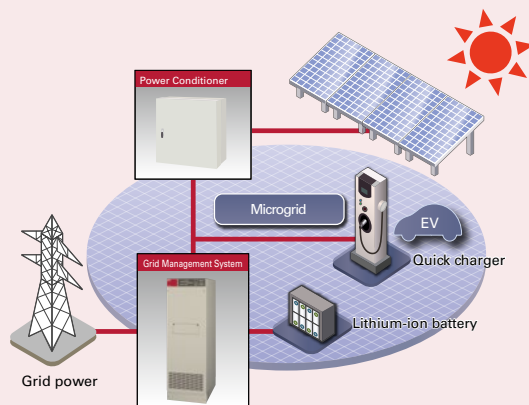

## Problem

Need a solution for momentary power outages, but have a limited installation space?

## Solved!

A voltage dip compensator with a built-in EDLC (electric double layer capacitor) provides protection

Our voltage dip compensator with a built-in EDLC requires less space than a UPS with lead-acid batteries.

In the event of a voltage dip or momentary outage of less than 1 second, the dip compensator ensures that loads will be powered with a pure sine wave without interruption. With a long-life EDLC, maintenance-free operation can also be expected.

Dip compensation time

1s

During a momentary outage

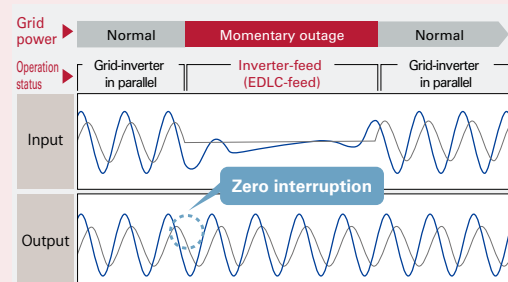

# Motion, smoother and more precise

For FA equipment and industrial machinery that require high precision and accurate positioning. To ensure the stability of manufacturing and social infrastructure, it is vital for equipment to move precisely as instructed. SANMOTION has a rich lineup of motors with smooth driving and products that control them with high precision. The value of equipment is enhanced through sure motion and stopping.



## In automated factories



In an articulated robot on a production line, the smooth motion of the arm is achieved through the precise synchronized driving of multiple SANMOTION Servo Systems.

## In medical clinics



SANMOTION Servo Systems are used in a wide variety of equipment such as diagnostic, testing, and analysis devices, as well as electric beds used in hospital wards.

# Why they choose SANMOTION?

Point

1

## Highly reliable design, flexible customization

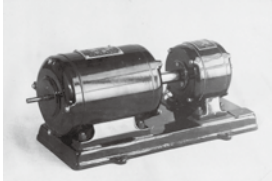

1952 Servo Motor Prototype

Since we developed the first domestic servo motors in 1952, we have been making high-quality servo systems and stepping systems. They are equipped with the high performance that we have cultivated along with our technical history. We also offer flexible customization to best suit the customer's equipment.

Point

2

## Rich lineup

We offer a wide lineup that includes motors with precise positioning, and amplifiers, drivers, and controllers for controlling them.



Stepping Systems

**SANMOTION F2** (2-Phase)  
**SANMOTION F3** (3-Phase)  
**SANMOTION F5** (5-Phase)



Closed Loop Stepping Systems

**SANMOTION Model No.PB**



AC Servo Systems

**SANMOTION G**  
**SANMOTION R**



DC Servo Systems

**SANMOTION K**

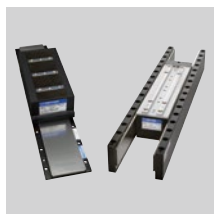

**SANMOTION**

Linear Servo Systems



Motion Controllers

**SANMOTION C**

Point

3

## Meticulous pre-sales service

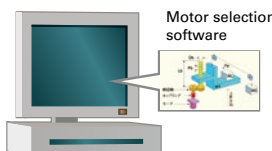

Motor selection software

We offer software to assist you in selecting the best motor for your equipment. Also, our dedicated setup software makes it easy to set up systems. In addition, our technical assistance service can help improve the precision of your equipment.



Analyzer



Camera swinging

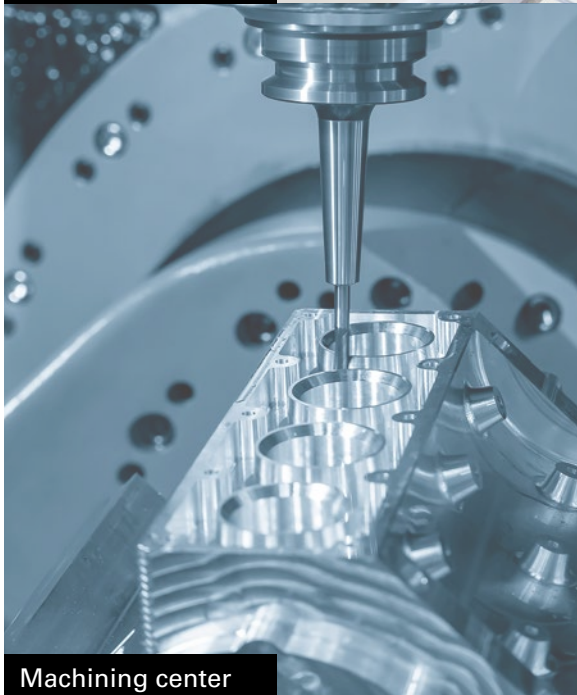

Machining center

Automatically,  
Quickly,  
Precisely, and  
Repeatedly



Electric bed



Collaborative robot

**SANMOTION motors** are the best choice because they can

move a set distance,

at a set speed,

within a set time



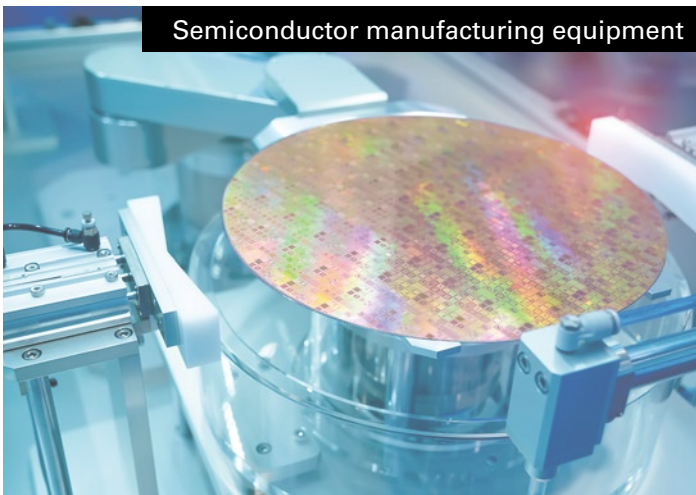

Semiconductor manufacturing equipment



Press machine



Machining

# Accurate Stopping and Smooth Motion

- Pressing
- Pulling
- Injecting
- Inserting
- Processing
- Moving
- Lifting
- Rotating
- Affixing labels
- Gripping



Labeling machine



Belt conveyor, filling machine

You can narrow down motors and amplifiers with the **Advanced Search** on our Product Site.

[https://products.sanyodenki.com/en/sanmotion/search/ac\\_servo/](https://products.sanyodenki.com/en/sanmotion/search/ac_servo/)



# Problem

# Want to easily perform positioning control?

## Solved!

### Simple stepping systems without encoders

#### Stepping Systems

- SANMOTION F2 (2-Phase)**
- SANMOTION F3 (3-Phase)**
- SANMOTION F5 (5-Phase)**



Stepping motors are driven precisely at a set angle (Full step angle) according to the number of pulses input to the driver from a pulse oscillator. These use open-loop control without an encoder (position detection sensor), helping build simple and low-cost systems. Ease of use is a key point. In addition, they use holding force when stopped, and feature stable stopping without micro vibrations.

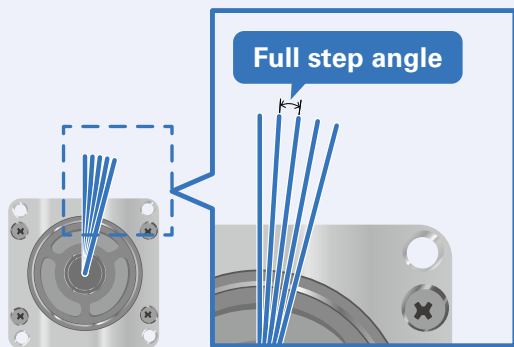
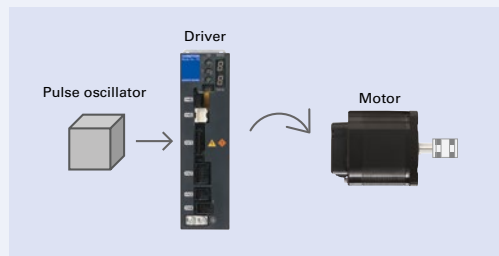

2-phase	Full step angle <b>1.8°</b>	<b>200</b> divisions
3-phase	Full step angle <b>1.2°</b>	<b>300</b> divisions
5-phase	Full step angle <b>0.72°</b>	<b>500</b> divisions

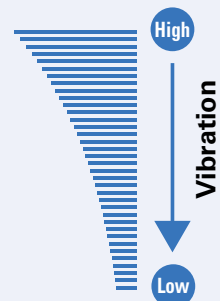

The more subdivisions, the smaller the vibration, and the more precise and smooth motion can be achieved.

### Application example: Food manufacturing equipment

#### With an induction motor

As the motor speed is affected by the viscosity of the filling material, the number of rotations must be adjusted by an inverter. Startup time is also slow.

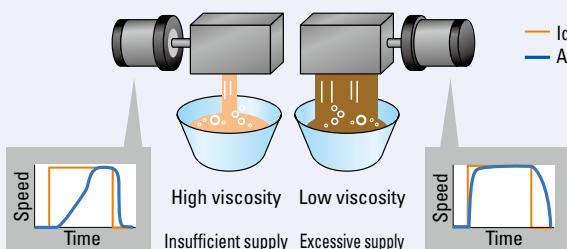

#### With a stepping motor

Stepping motors can stably dispense a constant amount because they simply rotate at a fixed angle regardless of the viscosity of the material. Startup time is also short.

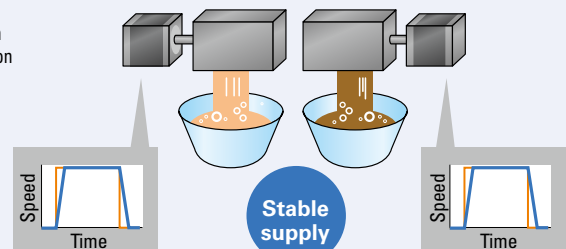

# Problem

The step-out and heat generation of stepping systems is a concern. And servo systems are too complicated...

# Solved!

Closed-loop control  
using encoder-equipped stepping motors

Closed Loop Stepping Systems

## SANMOTION Model No.PB



Closed loop stepping systems provide the ease of use of stepping systems and the reliability of servo systems. The stepping motor in these systems has an encoder that provides feedback to the driver to prevent step-out (misalignment), which is a weak point of stepping motors.

In addition, since the current flowing through the motor is controlled to match the device, these systems generate less vibration and heat compared to open loop stepping motors, and can be operated with higher efficiency.

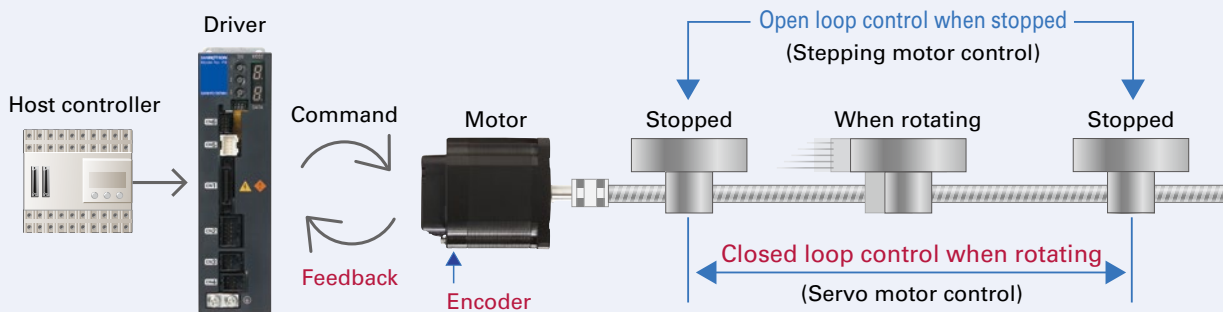

Compared to servo systems  
Lower cost  
Simpler systems  
Stable stopping (without hunting)

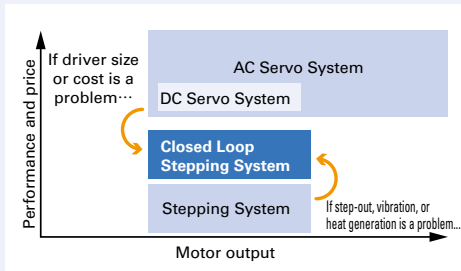

Compared to stepping systems  
No step-out  
Less vibration  
Less heat

Motor speed fluctuation characteristics comparison

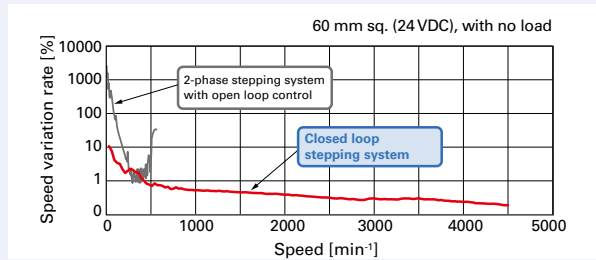

Motor temperature rise

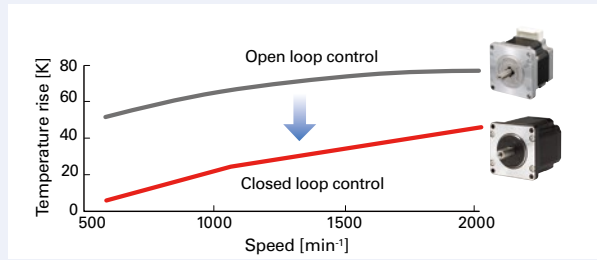

## Problem

# Want to make your factory automated and IoT-ready?

## Solved!

SANMOTION provides comprehensive motion control solutions with servo motors, servo amplifiers, and motion controllers.

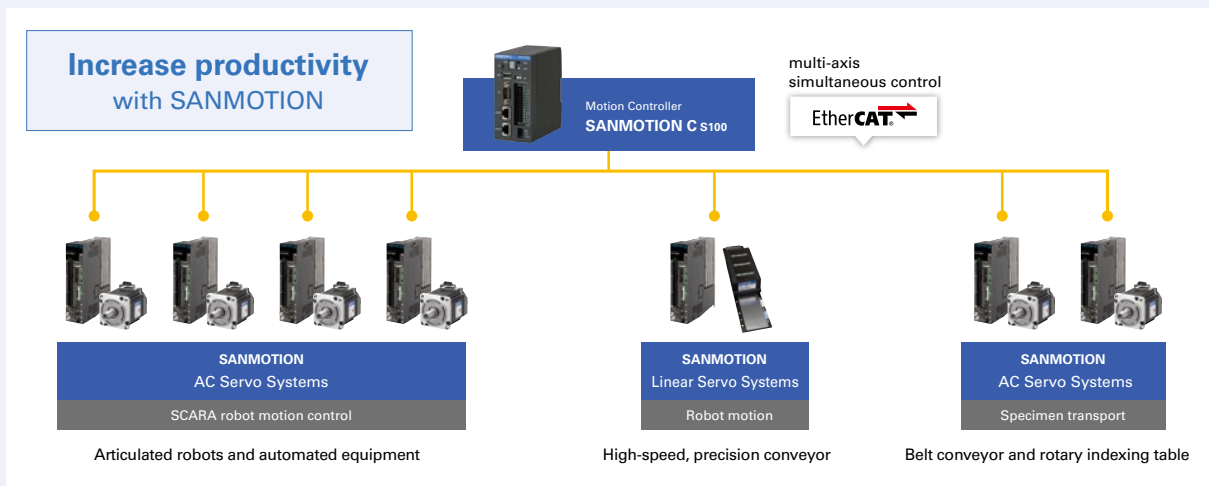

### AC Servo Systems

## SANMOTION G

This is a brand new compact, lightweight, and energy-efficient AC servo system with evolved servo performance. This servo system provides high-speed and high-precision control of equipment, greatly improving the productivity and processing quality. It has various safety functions to ensure the safety of operators, such as monitoring of power supply status and communication quality, estimation of the remaining life of the holding brake, and prevention of electronic component failures. In addition to standard rotary motors, compact, high-thrust linear servo motors are also available.

### SANMOTION R

We offer a wide range of servo motors with variations in capacity and feature. Servo amplifiers are available in analog/pulse, EtherCAT, built-in positioning, and functional safety types (with functional safety modules) that can be used with peace of mind for devices and robots that operate near people.



### Motion Controllers

## SANMOTION C S100 / S500

The SANMOTION S100 motion controller can perform synchronous control of up to 8 axes and robot control. The SANMOTION S500 is a high-end motion controller that can easily control 7-axis articulated robots and multiple robots, contributing to in-house robot motion planning. With a variety of open networks supported, it can contribute to making factories automated and IoT-ready by sharing information between devices in real time.

## Problem

Want to improve the precision of devices with low-speed driving?

### Solved!

DC servo systems that excel in low-speed operation

DC Servo Systems

## SANMOTION K



DC servo motors are less susceptible to interference and have less speed fluctuation, so they can provide stable driving even at low speeds. The lineup has low-voltage models (24 VDC) available which are safe for use in medical equipment and other applications close to people.



Application example:  
Coordinate measuring machine

## Problem

Want to make a small and simple table mechanism?

### Solved!

A custom motor with high thrust load capacity enables direct drive of index tables

#### Conventionally

Because a standard motor is unable to support the workpiece load directly, the table is indirectly driven using a pulley and timing belt.

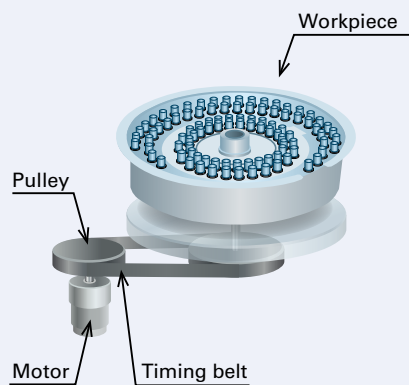

#### Solution

A customized heavy-duty hollow shaft stepping motor directly takes the load of the workpiece and simplifies the mechanism.

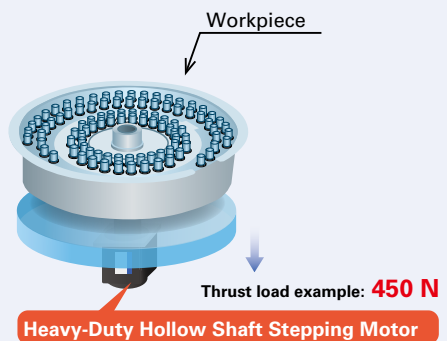

Besides this example, various customizations can be made to best suit your equipment.

■ Custom harness/shaft



■ Rotary damper, mounting surface damper



■ Gears, encoders, and brake

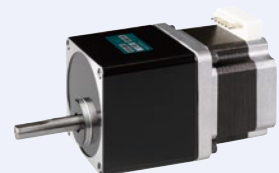

## DC Fan

The DC Fan lineup has a wide variety of models that feature high airflow and high static pressure

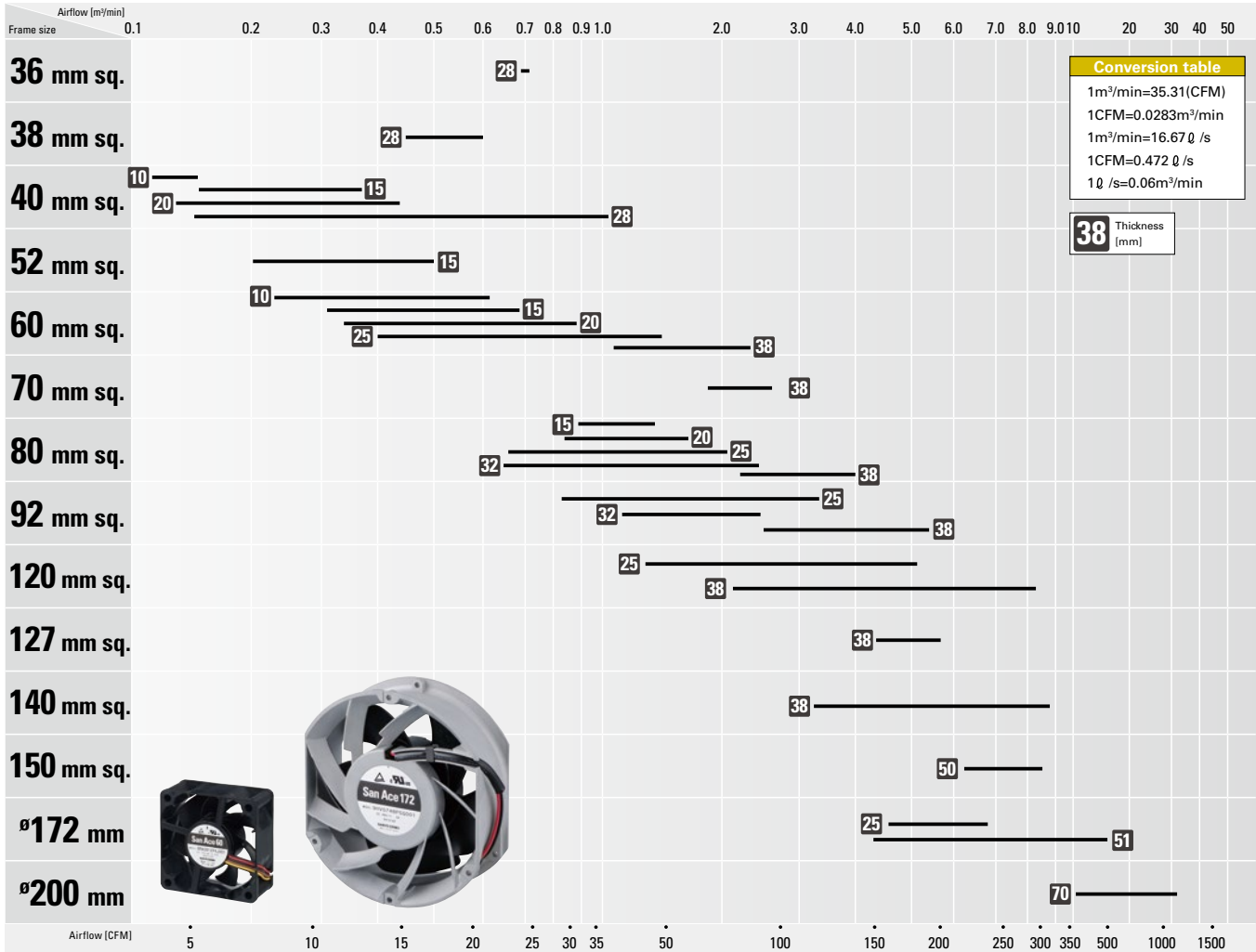

## Counter Rotating Fan

Fans that have higher airflow and static pressure than two equally sized DC fans operated in series

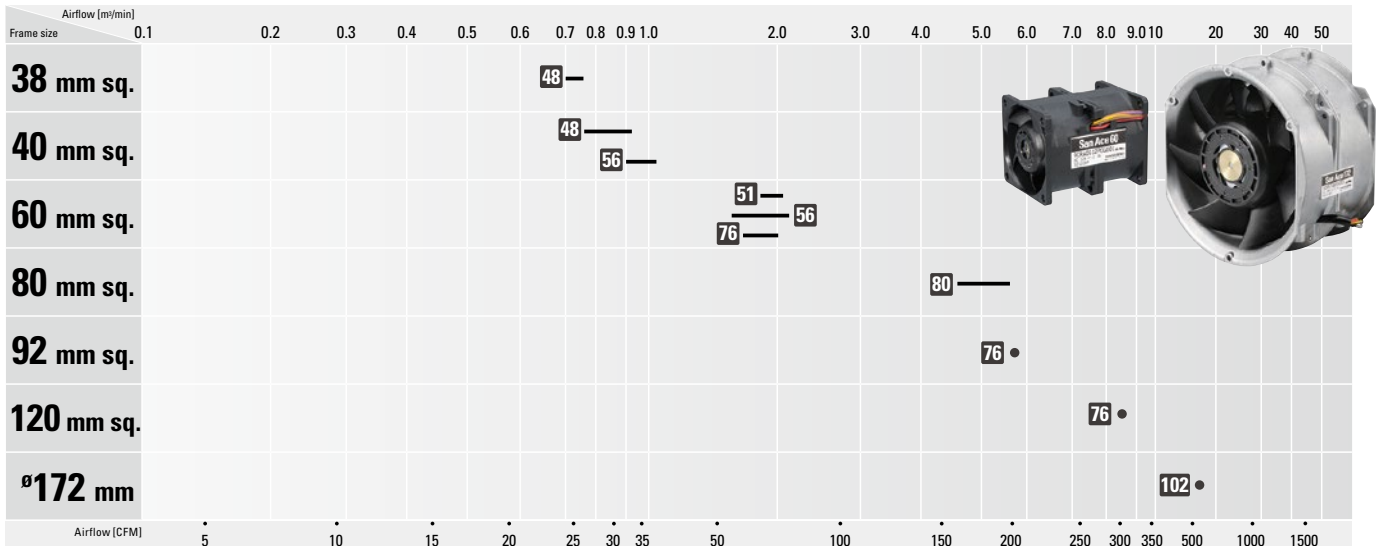

Depending on the model, these sensor options are available. ⇒ **Without sensor** **Pulse sensor** **PWM control function** Please contact your point of sale regarding ⇒ **Lock sensor** **Low-speed sensor**

## Reversible Flow Fan

Fans that can blow air in both directions, which can be switched

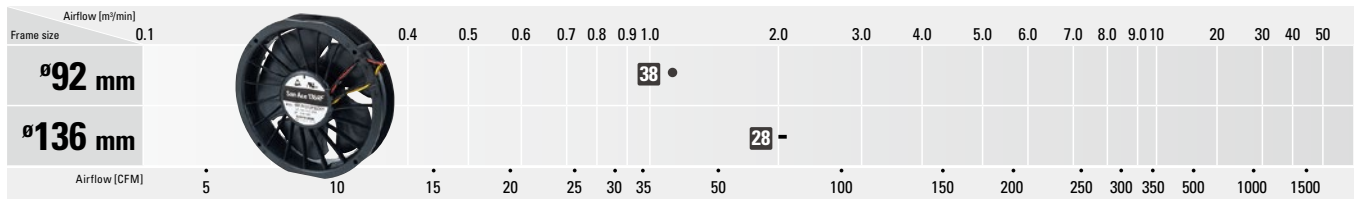

## Splash Proof Fan

Fans that feature water and dust protection of up to IP68

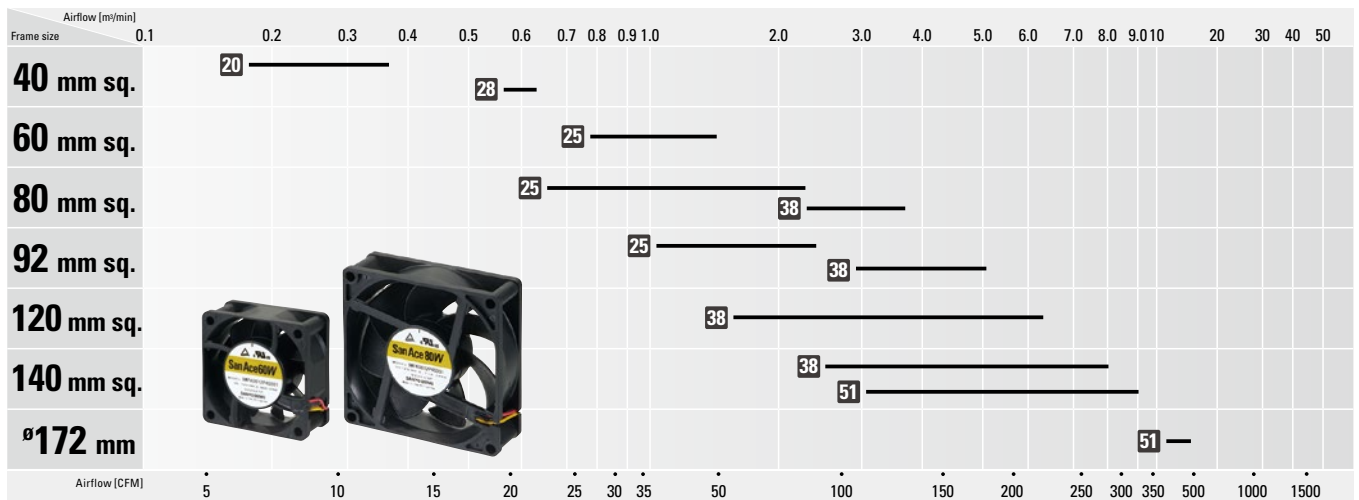

## Splash Proof Centrifugal Fan

High static pressure fans that blow air in a centrifugal course and feature water and dust protection of up to IP68

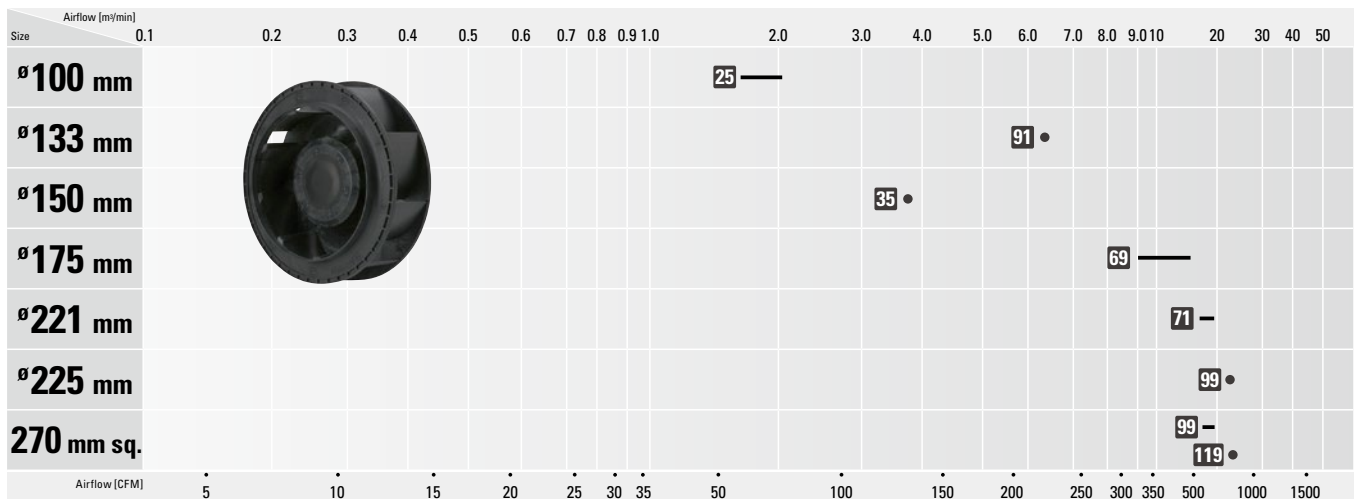

## Splash Proof Blower

High static pressure blower fans with IP68-rated water and dust protection

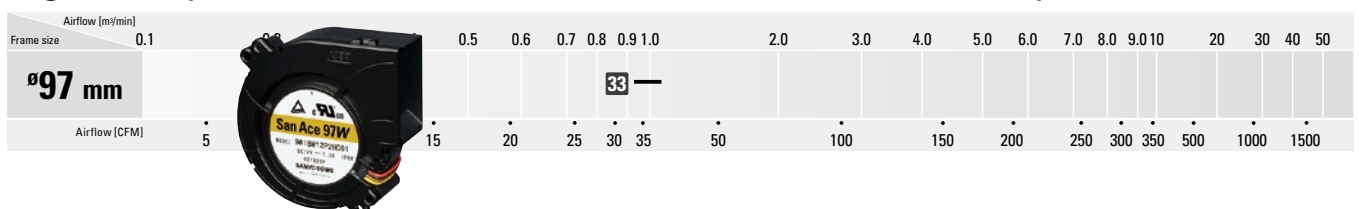

## Oil Proof Fan

Fans that can be used in oil mist environments

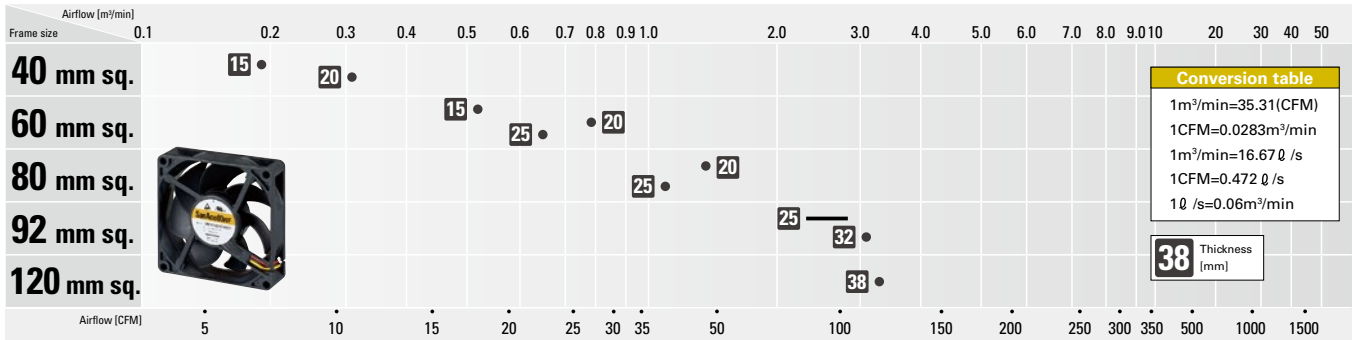

## Long Life Fan

Fans with an extended service life of up to 180,000 hours (approx. 20 years)

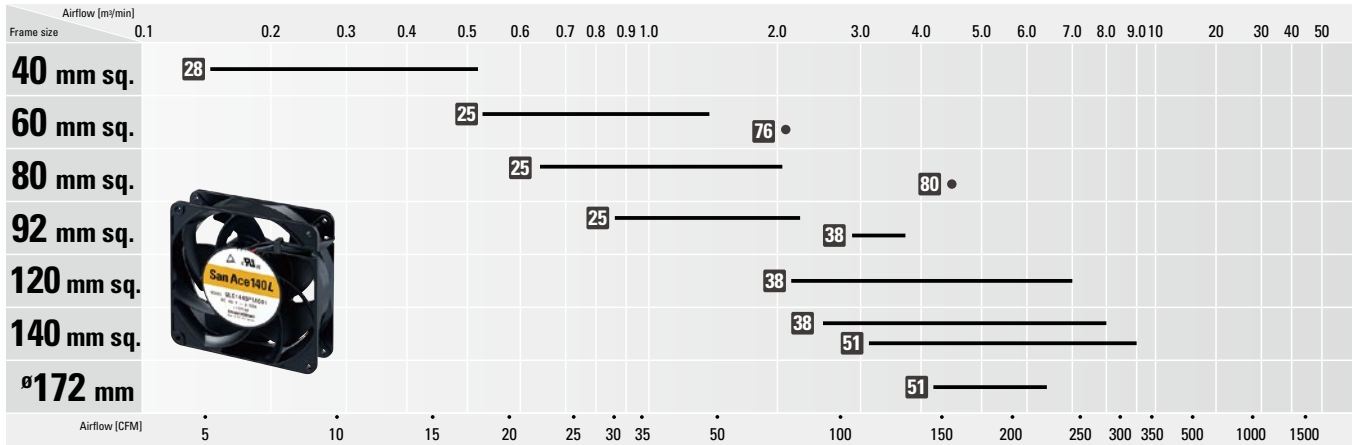

## Wide Temperature Range Fan

Fans with a wide operating temperature range of -40°C to +85°C

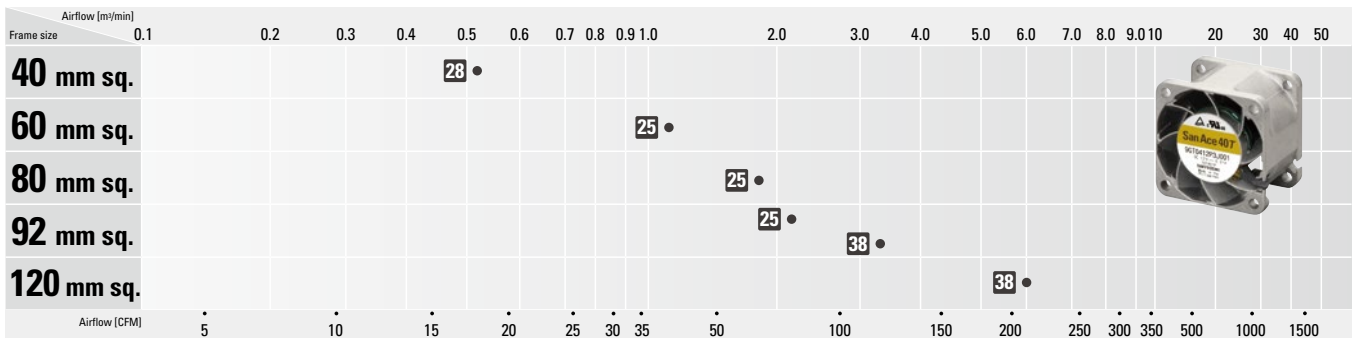

## G Proof Fan

Fans that can withstand high levels of G-force

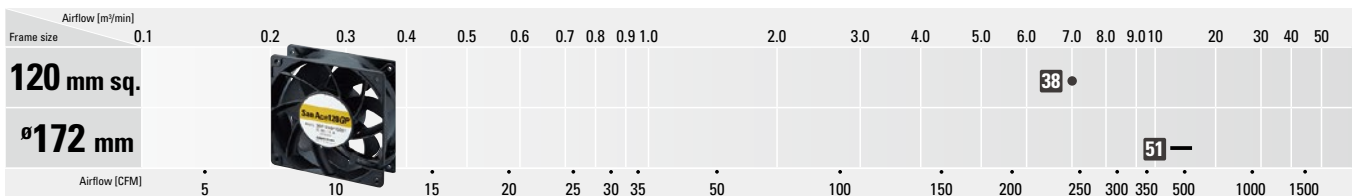

Depending on the model, these sensor options are available. ⇒ **Without sensor** **Pulse sensor** **PWM control function** Please contact your point of sale regarding ⇒ **Lock sensor** **Low-speed sensor**



## Centrifugal Fan

High static pressure and high airflow fans that blow air in a centrifugal course

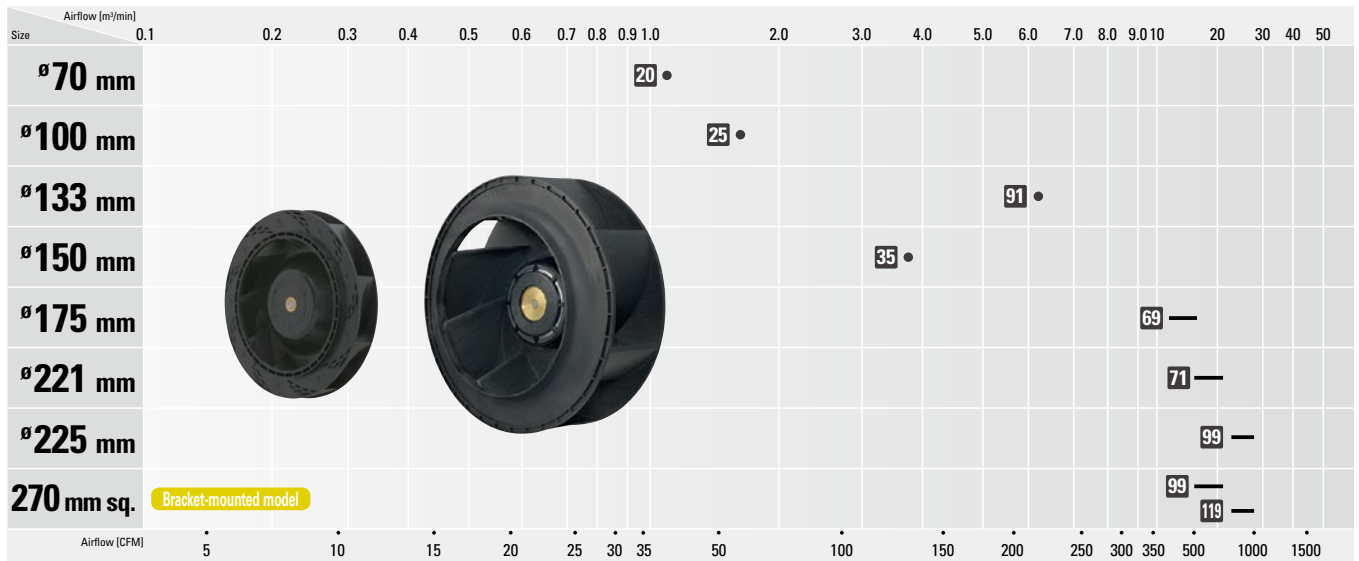

## Blower

Fans that are specialized in high static pressure

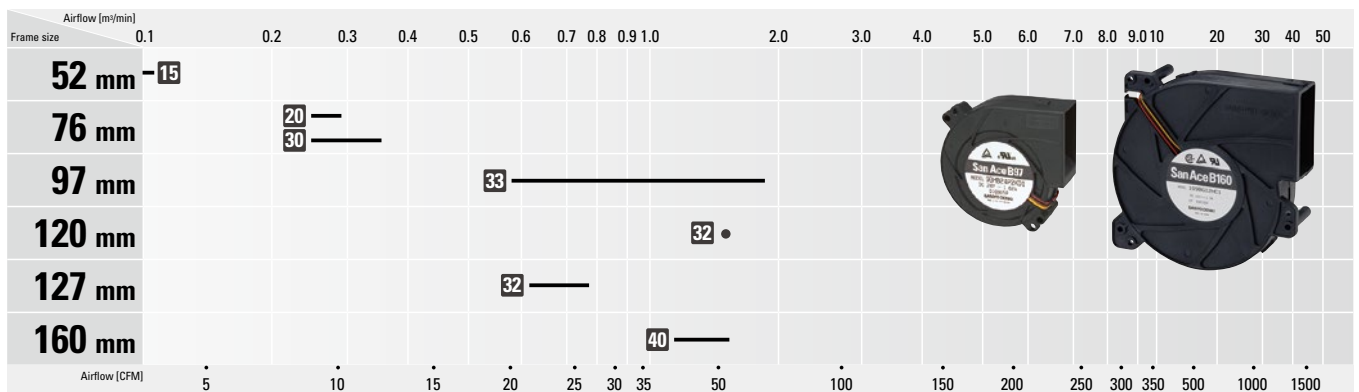

## ACDC Fan

AC-powered fans with low power consumption and long service life

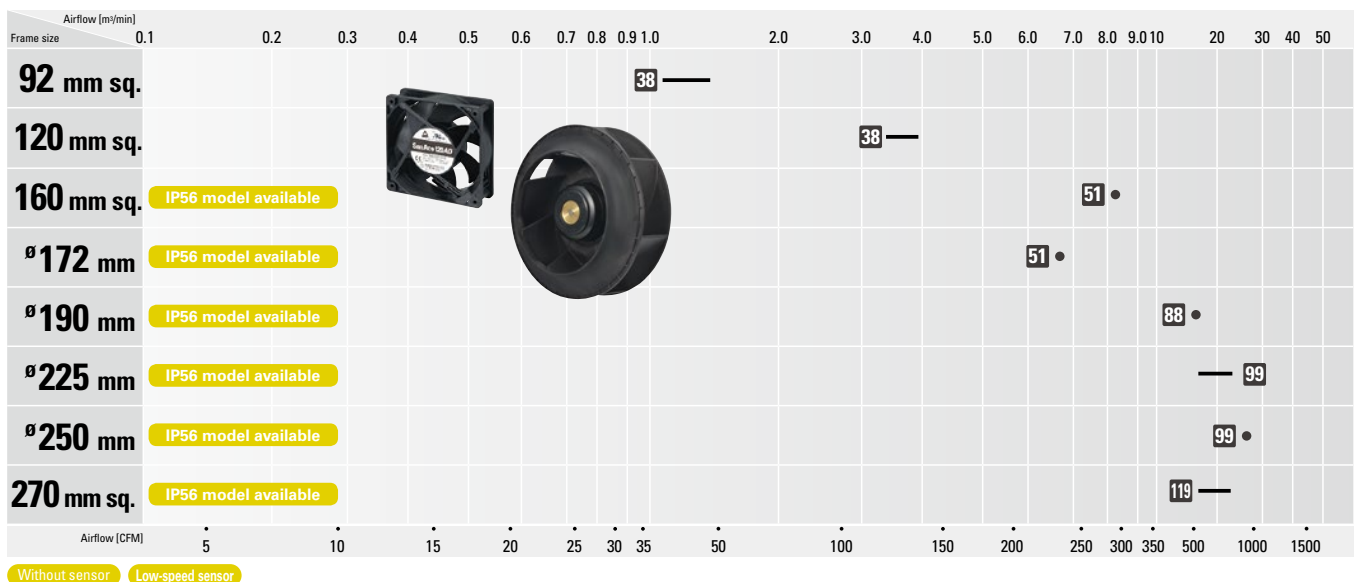

Without sensor Low-speed sensor

## AC Fan

### AC-powered cooling fans

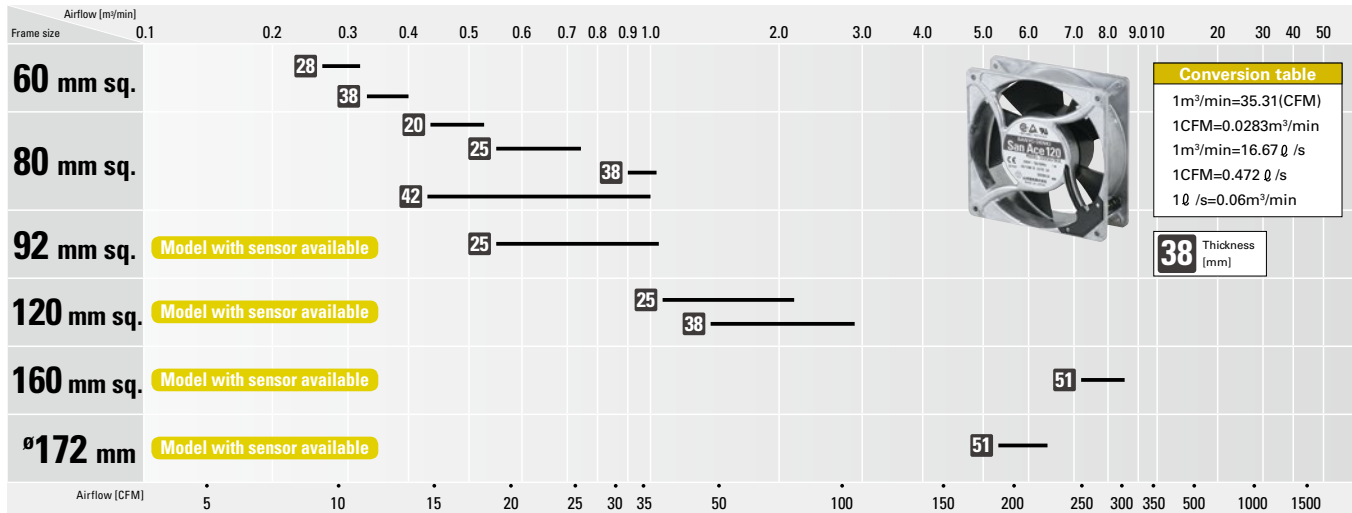

### Options

#### Finger guards

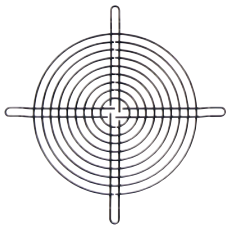

High-quality finger guards prevent foreign objects from entering the fan, enhancing safety. They do not significantly affect the fan's airflow and static pressure performance and provide stable fan operation.

For 36 to 270 mm sq. fans and ø92 to ø250 mm fans

#### EMC guards

A piece of metal for protecting fans from electromagnetic noise.

For 80 to 120 mm sq. and ø172 mm DC Fans

#### Resin finger guards

For 60 to 120 mm sq. fans

#### Resin filter kits

Filters the dust in the suctioned air.

For 60 to 120 mm sq. fans

#### Inlet nozzle for Centrifugal Fans and Splash Proof Centrifugal Fans

Equipment to be mounted to the inlet side of fans for adjusting incoming flow of air.

For ø70 to ø250 mm fans

- Filter kits, screen kits  
For 120 × 120 × 38 mm AC Fans
- Plug cords  
For 80 to 160 mm sq. and ø172 mm AC Fans

### San Ace Controller



It can optimize airflow and static pressure of fans by controlling individual fan speeds.

In addition, since the sensor's measurement value can be used for automatic control, it contributes to low noise and energy savings in devices.

In addition to connection via the customer's terminal through wireless or wired LAN, remote monitoring and control can be done via a cloud server.

	With wireless LAN	Without wireless LAN	With wireless LAN, cUL certified
Model no.	9CT1-001	9CT1-002	9CT1-U001 (Use a UL Class 2 power supply.)
Rated voltage	12/24/48 VDC		12/24 VDC
Operating voltage range	7 to 60 VDC		7 to 27.6 VDC
Operating temperature range	-20 to +70°C		
Control signal	PWM signal, high-level voltage (V <sub>OH</sub> ): 3.3/5 V, frequency: 25 kHz		
Monitoring criteria	Fan speed, fan current, fan operation hours, sensor detection value, external input		
Allowable fan connection terminal current	5 A (per terminal)		5 A (12 VDC), 4 A (24 VDC)
Dimensions (W × H × D)	50 × 180 × 135 mm		
Mass	450 g		

Sensor type	Temperature/humidity sensor	Barometer	Accelerometer
Model no.	9CT1-T	9CT1-P	9CT1-A
Measurement range	Temperature: -20 to +70°C Humidity: 20 to 85% RH <sup>(1)</sup>	Barometric pressure: 800 to 1100 hPa	Acceleration: 0 to 60 m/s <sup>2</sup> (2)
Operating temperature range	-20 to +70°C		
Operating humidity range	20 to 85% RH <sup>(1)</sup>		
Dimensions (W × H × D)	53 × 22 × 46 mm		
Mass	35 g		

(1) Non-condensing (2) Total acceleration from 3-axes

## PWM Controller

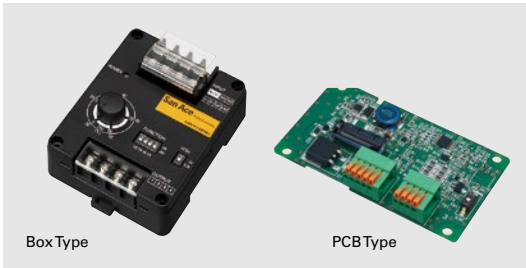

You can control the speed of fans with the PWM control function. Contributes to reduced system power consumption and noise.

Type		Box Type	PCB Type
Rated voltage		12/24/48 VDC	
Power consumption		0.2 W*	
Operating temperature range		-20 to +70°C	
Input terminal	Input voltage range	7 to 60 V	
Output terminal	PWM signal output	High-level voltage (V <sub>OH</sub> ): 3.3 or 5 V selectable	
	No. of connectable fans	Max. 4	
Mounting method		DIN rail mounting or screw mounting	Screw mounting
Dimensions (W × H × D)		66 × 86 × 38 mm	45 × 80 × 17 mm
Mass		110 g	27 g
Material		Case: Plastic	PCB: FR-4

\* When output terminals are turned on.

Be noted that if applied input voltage or frequency is out of range of the connected fan, how the fan speed responds to the PWM duty cycle may be altered.

## Airflow Tester



This compact, portable, and easy-to-operate measuring instrument can measure the system impedance and airflow in devices.

Model no.		9AT2560S-000□*	9AT2560A-000□*	9AT2560C-000□*
Measurement range	Airflow	0.20 to 8.00 m <sup>3</sup> /min (Resolution: 0.01 m <sup>3</sup> /min)	7 to 282 CFM (Resolution: 1 CFM)	7 to 282 CFM (Resolution: 1 CFM)
	Static pressure	0 to 1,000 Pa (Resolution: 1 Pa)	0 to 4.01 inchH <sub>2</sub> O (Resolution: 0.01 inchH <sub>2</sub> O)	0 to 1,000 Pa (Resolution: 1 Pa)
Measurement accuracy	Airflow	Within ±7% of maximum airflow measured with each nozzle		
	Static pressure	Within ±10 Pa (0.04 inH <sub>2</sub> O) of measurements < 200 Pa, Within ±50 Pa (0.20 inH <sub>2</sub> O) of measurements ≥ 200 Pa		
Operating/storage environment	Ambient temperature	0 to +40°C		
	Humidity	20 to 85% RH (non-condensing)		
Display function		Data no., measurement values (airflow, static pressure**), measurement status, nozzle selection, measurement mode		
Communication protocol		Digital output: Use a dedicated USB cable		
Input power		Input voltage 100 to 240 VAC, 50/60 Hz		
Dimensions (W × H × D)		600 × 250 × 250 mm		
Mass		Main unit: Approx. 6 kg Connection duct (including board holder): Approx. 1.5 kg		

\* The AC power plug shape differs with the number in □ of model numbers.

AC power plug included in models with 1 in □ is for Japan and North America regions (2 parallel flat pins + a round grounding pin), Input voltage: 100/120 VAC, 50/60 Hz  
AC power plug included in models with 2 in □ is for Europe region (2 round pins + a female grounding contact), Input voltage: 220 VAC, 50 Hz  
AC power plug included in models with 3 in □ is for China region (2 angled flat pins + a flat grounding pin), Input voltage: 220 VAC, 50 Hz

Product also available without an AC power cable. Model no. 9AT2560S-0000, 9AT2560A-0000, 9AT2560C-0000

\*\* Static pressure in Pa, where standard atmosphere is 1013 hPa at 20°C.

## Cooling Fan Units

### Examples



- With a variety of fans from our lineup, the optimal cooling fan unit specifically tailored to your needs can be built.
- The pictures above are only a few examples. We are willing to design and develop a custom cooling fan unit optimized for your requests. Contact us for details.

## Air Purifier San Ace Clean Air



This air purifier has a high airflow of 16.5 m<sup>3</sup>/min and can cover a room of 127 m<sup>2</sup>, which is suitable for large rooms such as offices and conference rooms. Smaller rooms can be cleaned more quickly, with 13.2 m<sup>2</sup> cleaned in less than 4 minutes.

Note: This product is designed for use in Japan only.

Model no.	9AP1600-1			
Dimensions (W × H × D)	500 × 1600 × 400 mm			
Mass	40 kg			
Input power	Single-phase 100 V (50/60 Hz common)			
Power cord length	2.6 m			
Room coverage	127 m <sup>2</sup> or less*			

\* Calculated by the test method based on the JEMA's JEM 1467 standard.

Operation mode	1 [Low]	2 [Medium]	3 [High]	Automatic
Airflow	3.2 m <sup>3</sup> /min	10.5 m <sup>3</sup> /min	16.5 m <sup>3</sup> /min	Built-in sensors detect dust and odors to automatically select the optimal operation mode.
Operating power consumption*	18 W	28 W	90 W	
Noise level	30 dB(A)	45 dB(A)	54 dB(A)	

\* Standby power consumption is 3 W

## Uninterruptible Power Supply (UPS) with Lithium-Ion Batteries

Hybrid UPS

### SANUPS E11B-Li



UPS unit  
3-year warranty



Input/Output	Output capacity			Battery backup time
AC 100, 110, 115, 120 V Single-phase 2-wire	1 kVA (0.8 kW)	1.5 kVA (1.2 kW)	2 kVA (1.6 kW)	4 min
AC 200, 208, 220, 230, 240 V Single-phase 2-wire	1 kVA (0.8 kW)	2 kVA (1.6 kW)		

Online UPS

### SANUPS A11M-Li



UPS unit  
3-year warranty



Input/Output	Output capacity	Battery backup time
AC 100, 110, 115, 120 V Single-phase 2-wire	1 to 8 kVA (0.8 to 6.4 kW)	4 min
AC 200, 208, 220, 230, 240 V Single-phase 2-wire		

#### Parallel Redundant Configurations

N configuration	2 kVA (1.6 kW)	3 kVA (2.4 kW)	4 kVA (3.2 kW)	5 kVA (4.0 kW)	6 kVA (4.8 kW)	7 kVA (5.6 kW)	8 kVA (6.4 kW)
N+1 configuration	1 kVA (0.8 kW)	2 kVA (1.6 kW)	3 kVA (2.4 kW)	4 kVA (3.2 kW)	5 kVA (4.0 kW)	6 kVA (4.8 kW)	7 kVA (5.6 kW)

Hybrid UPS

### SANUPS E11A-Li



UPS unit  
3-year warranty



Input/Output	Output capacity	Battery backup time
AC 100, 110, 115, 120 V Single-phase 2-wire	350 VA (245 W)	8 min

Dimensions [mm]			
Width	Height	Depth	Mass
250	69	365	7 kg

Online UPS

## SANUPS A11K-Li



Battery backup time: 8 to 19 min

Input/Output	Output capacity				
100/110/120 VAC Single-phase 2-wire	1 kVA (0.8 kW)	1.5 kVA (1.2 kW)	2 kVA (1.6 kW)	3 kVA (2.4 kW)	5 kVA (4 kW)

Battery backup time and dimensions [mm]											
Output capacity [kVA]	Time	Width	Height	Depth	Mass	Output capacity [kVA]	Time	Width	Height	Depth	Mass
1	13 min	191	477	440	17 kg	3	9 min	234	435	625	32 kg
1.5	8 min			488	18 kg		19 min			690	47 kg
	19 min			625	27 kg						
2	15 min										

Note: Including the vertical stand and floor mounting bracket dimensions



Battery backup time: 30 to 400 min

Input/Output	Output capacity		
100/110/120 VAC Single-phase 2-wire	1.5 kVA (1.2 kW)	3 kVA (2.4 kW)	5 kVA (4 kW)

Battery backup time			
Output capacity [kVA]	1.5	3	5
Backup time [min]	100 to 400	50 to 200	30 to 90

Dimensions [mm]									
Free-standing type					Rack mount type				
Output capacity [kVA]	Width	Height	Depth	Mass	Output capacity [kVA]	Width*	Height**	Depth	Mass**
1.5	317.5	443	520	66 kg	1.5	480	86 + 175	520	14+52 kg
3	365			74 kg	131 + 175		22+52 kg		
5	409			82 kg	175 + 175		30+52 kg		

Note: Including the vertical stand and floor mounting bracket dimensions

\* Including rack mounting bracket dimensions  
\*\* Height/Mass of UPS unit + battery unit

Standby UPS

## SANUPS N11C-Li

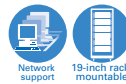

Input/Output	Output capacity		
100/110/120 VAC Single-phase 2-wire	1.5 kVA (1.2 kW)	3 kVA (2.4 kW)	5 kVA (4 kW)

Battery backup time			
Output capacity [kVA]	1.5	3	5
Backup time [min]	100 to 400	50 to 200	30 to 90

Dimensions [mm]									
Free-standing type					Rack mount type				
Output capacity [kVA]	Width	Height	Depth	Mass	Output capacity [kVA]	Width*	Height**	Depth	Mass**
1.5	317.5	443	520	66 kg	1.5	480	86 + 175	520	14+52 kg
3	365			74 kg	131 + 175		22+52 kg		
5	409			82 kg	175 + 175		30+52 kg		

Note: Including the vertical stand and floor mounting bracket dimensions

\* Including rack mounting bracket dimensions  
\*\* Height/Mass of UPS unit + battery unit

Standby UPS

## SANUPS N11B-Li



Input/Output	Output capacity		
100/110/120 VAC Single-phase 2-wire	1 kVA (0.8 kW)	1.5 kVA (1.2 kW)	3 kVA (2.4 kW)
200/220/230/240 VAC Single-phase 2-wire	1 kVA (0.8 kW)		

Battery backup time				
100 V models				
Output capacity [kVA]	1	1.5	3	
Backup time [min]	150	150	30	
200 V models				
Output capacity [kVA]	1			
Backup time [min]	100			

Dimensions [mm]				
Output capacity [kVA]	Width	Height	Depth	Mass
1 (100 V models)	300	950	250	65 kg
1 (200 V models)	450	950	300	90 kg
1.5				85 kg
3				80 kg

IP65

## Uninterruptible Power Supply (UPS)

Hybrid UPS

### SANUPS E11B



Input/Output	Output capacity				Battery backup time
100/110/115/120 VAC Single-phase 2-wire	1 kVA (0.8 kW)	1.5 kVA (1.2 kW)	2 kVA (1.6 kW)	3 kVA (2.4 kW)	3 min (5 min)*
200/208/220/230/240 VAC Single-phase 2-wire	1 kVA (0.8 kW)	2 kVA (1.6 kW)	3 kVA (2.4 kW)		

\* In parentheses are the values at a load power factor of 0.7.

Dimensions [mm]				
Output capacity [kVA]	Width	Height	Depth	Mass
1	480	86	408 (+8)	15 kg
1.5	480	86	500 (+8)	20 kg
2	480	86	565 (+8)	25 kg
3	480	86	750 (+8)	39 kg

Hybrid UPS

### SANUPS E11A



Input/Output	Output capacity			
100/110/115/120 VAC Single-phase 2-wire	0.35 kVA (0.245 kW)	0.75 kVA (0.525 kW)	1 kVA (0.7 kW)	1.5 kVA (1.05 kW)

Battery backup time				
Output capacity [kVA]	0.35	0.75	1	1.5
Standard backup time [min]	6		5	
Available options* [min]	—		20 to 60	

\* For 1 to 3 kVA models, except for the tower type, the backup time can be extended by combining optional external battery modules.

Dimensions [mm]				
■ Standard type				
Output capacity [kVA]	Width	Height	Depth	Mass
0.35	250	69	365	8 kg
0.75	350	86	408	13.5 kg

■ Tower type				
Output capacity [kVA]	Width	Height	Depth	Mass
0.75	150	250	350	14 kg
1			395	17 kg
1.5			450	22 kg

Online UPS

### SANUPS A11K



Input/Output	Output capacity				
100/110/120 VAC Single-phase 2-wire	1 kVA (0.8 kW)	1.5 kVA (1.2 kW)	2 kVA (1.6 kW)	3 kVA (2.4 kW)	5 kVA (4 kW)

Battery backup time					
Output capacity [kVA]	1	1.5	2	3	5
Backup time [min]	10 to 180				10 to 120

Dimensions [mm]					
■ Vertical type					
Output capacity [kVA]	Width	Height	Depth	Mass	
1	191	447	440	22 kg	
1.5			488	29 kg	
2			625	40 kg	
3	190	443	625	58 kg	
5	234		690	80 kg	

■ Rack mount type						
Output capacity [kVA]	Width	Height	Depth	Mass		
1	480	86	440	22 kg		
1.5			488	29 kg		
2			625	40 kg		
3			131	625	58 kg	
5			175	690	80 kg	

Note: Including the vertical stand and floor mounting bracket dimensions

Note: Including rack mounting bracket dimensions

Online UPS

## SANUPS A11M





**UPS unit**  
**3-year warranty**





Input/Output	Output capacity	Battery backup time
100/110/115/120 VAC Single-phase 2-wire	1 to 8 kVA (0.8 to 6.4 kW)	3 min (5 min)*
200/208/220/230/240 VAC Single-phase 2-wire		

\* In parentheses are the values at a load power factor of 0.7.

### Parallel Redundant Configurations

N configuration	2 kVA (1.6 kW)	3 kVA (2.4 kW)	4 kVA (3.2 kW)	5 kVA (4.0 kW)	6 kVA (4.8 kW)	7 kVA (5.6 kW)	8 kVA (6.4 kW)
N+1 configuration	1 kVA (0.8 kW)	2 kVA (1.6 kW)	3 kVA (2.4 kW)	4 kVA (3.2 kW)	5 kVA (4.0 kW)	6 kVA (4.8 kW)	7 kVA (5.6 kW)

Dimensions [mm]				
	Width	Height	Depth	Mass
UPS unit	480	86	408+8	15 kg

Note: Combine UPS units with a power distribution unit.

Online UPS

## SANUPS A11N





**UPS unit**  
**3-year warranty**



Input	Output	Output capacity	Battery backup time
200 VAC single-phase 2-wire	200 VAC single-phase 2-wire	5 to 20 kVA (4.5 to 18 kW)	5 min
	100 VAC single-phase 2-wire or 100/200 VAC single-phase 3-wire		

### Parallel Redundant Configurations

N configuration	5 kVA (4.5 kW)	10 kVA (9 kW)	15 kVA (13.5 kW)	20 kVA (18 kW)
N+1 configuration	—	5 kVA (4.5 kW)	10 kVA (9 kW)	15 kVA (13.5 kW)

Dimensions [mm]					
Output capacity	Battery backup time	Width	Height	Depth*	Mass
5 kVA (single unit)	5 min	435	130	700+40	63 kg
10 kVA (single unit)			260	700+105	127 kg

\* Depth of UPS unit + cable cover

## Uninterruptible Power Supply (UPS)

Online UPS

### SANUPS A11J



Input	Output	Output capacity			
100 VAC or 200 VAC single-phase 2-wire	100 VAC single-phase 2-wire or 100/200 VAC single-phase 3-wire	5 kVA (4.5 kW)		10 kVA (9 kW)	
200 VAC single-phase 2-wire	200 VAC single-phase 2-wire	5 kVA (4.5 kW)	10 kVA (9 kW)	15 kVA (13.5 kW)	20 kVA (18 kW)
	100 VAC single-phase 2-wire or 100/200 VAC single-phase 3-wire				

Parallel redundant operation

Single-unit/Parallel operation

Output capacity			Output capacity			
5 kVA (4.5 kW)	10 kVA (9 kW)	15 kVA (13.5 kW)	5 kVA (4.5 kW)	10 kVA (9 kW)	15 kVA (13.5 kW)	20 kVA (18 kW)

Battery backup time

Standard backup time [min]	5	10
	3U models	4U models
Available options [min]	15 to 180 Note that not all possible combinations of the installation type and output capacity are available.	

Dimensions [mm]

Output capacity	Battery backup time	Width	Height	Depth*	Mass
5 kVA (single unit)	5 min	435	130	700+30	61 kg
	10 min		351	700+80	113 kg

\* Depth of UPS unit + cable cover

● UL/CE certified models

Input	Output	Output capacity			
200 VAC single-phase 2-wire	200 VAC single-phase 2-wire	5 kVA (4.5 kW)	10 kVA (9 kW)	15 kVA (13.5 kW)	20 kVA (17 kW)

Battery backup time

Standard backup time [min]	5
----------------------------	---

Dimensions [mm]

Output capacity [kVA]	Width	Height	Depth*	Mass
5	435	130	700+115	61 kg
10		262	700+121	126 kg

\* Depth of UPS unit + cable cover

Online UPS

### SANUPS A22A



UPS unit

3-year warranty



400 VAC model

Input	Output	Output capacity
380/400/415 VAC 3-phase 4-wire	380/400/415 VAC 3-phase 4-wire	5 to 105 kVA

200 VAC model

Input	Output	Output capacity
380/400/415 VAC 3-phase 4-wire	220/230/240 VAC Single-phase 2-wire	5 to 55 kVA

Battery backup time

Standard backup time [min]	10
----------------------------	----

Dimensions [mm]

	Width	Height*	Depth	Mass
Cabinet	600	1700 + 100	1000	Approx. 160 kg
(Half-size)	600	1150 + 100	1000	Approx. 125 kg

\* Support base height included

Online UPS

### SANUPS A23D



Input/Output	Output capacity			
AC 200, 210, 220 V 3-phase 3-wire	30 kVA (27 kW)	50 kVA (45 kW)	75 kVA (67.5 kW)	100 kVA (90 kW)

Battery backup time

Standard backup time [min]	10
Available options [min]	5 to 180

Dimensions [mm]

■ Inverter panel

Output capacity [kVA]	Width	Height*	Depth	Mass
30	600	1775	700	335 kg
50				350 kg
75				560 kg
100	800	1950		570 kg

\* Support base height included

Note: Contact us for the dimensions of battery cabinets.



Online UPS  
**SANUPS A23C**



Input/Output
200/210 VAC 3-phase 3-wire

Output capacity			
30 kVA (27 kW)	50 kVA (45 kW)	75 kVA (67.5 kW)	100 kVA (90 kW)
150 kVA (135 kW)	200 kVA (180 kW)	300 kVA (270 kW)	

Battery backup time	
Standard backup time [min]	10
Available options [min]	5 to 180

Dimensions [mm]	
-----------------	--

Inverter panel					
Output capacity [kVA]	Width	Height*	Depth	Mass	
30	600	1775	700	320 kg	
50				350 kg	
75	800	1950	800	600 kg	
100	1500			1250 kg	
200				1950 kg	
300	2200		900	1950 kg	

\* Support base height included  
Note: Contact us for the dimensions of battery cabinets.

Online UPS  
**SANUPS RMA**



Input/Output	Output capacity	
200 VAC 3-phase 3-wire	50 kVA (45 kW)	100 kVA (90 kW)

Battery backup time	
Standard backup time [min]	10
Available options [min]	5 to 180

Dimensions [mm]				
-----------------	--	--	--	--

Inverter panel				
Output capacity [kVA]	Width	Height	Depth	Mass
50	1000	1950	900	1100 kg
100	1900			2050 kg

Note 1: Contact us for installation dimensions.  
Note 2: For 60 minutes or longer backup times, consult with us.  
Note 3: Contact us for the dimensions of battery cabinets.

Parallel Processing UPS  
**SANUPS E23A**



Input/Output	Output capacity			
200/205/210 VAC 3-phase 3-wire	20 kVA (16 kW)	50 kVA (40 kW)	100 kVA (80 kW)	200 kVA (160 kW)

Battery backup time		
Output capacity [kVA]	20	50 to 200
Standard backup time [min]	8	10
Available options [min]	30 to 180	

Dimensions [mm]				
-----------------	--	--	--	--

Inverter panel				
Output capacity [kVA]	Width	Height*	Depth	Mass
20	500	1525	700	400 kg**
50		1775		350 kg
100	750	1950	800	600 kg
200	1500			1200 kg

\* Support base height included  
\*\* Including the weight of built-in battery  
Note: Contact us for battery cabinet dimensions.

Parallel Processing UPS  
**SANUPS E33A**



	Input/Output	Output capacity					
Parallel operation	380/400/415/420 VAC 3-phase 3-/4-wire	100 kVA (90 kW)	200 kVA (180 kW)	300 kVA (270 kW)	400 kVA (360 kW)	500 kVA (450 kW)	600 kVA (540 kW)
Parallel redundant operation		100 kVA (90 kW)	200 kVA (180 kW)	300 kVA (270 kW)	400 kVA (360 kW)	500 kVA (450 kW)	

Battery backup time		
Standard backup time [min]	5	10
Available options [min]	30 to 180	

Dimensions [mm]			
-----------------	--	--	--

	Width	Height*	Depth
UPS unit	700	1950	800

\* Support base height included  
Note 1: See our catalog for the dimensions of I/O panels.  
Note 2: Contact us for the dimensions of battery cabinets.

## Voltage Dip Compensator Highly efficient and reliable voltage dip compensator without interruption

### SANUPS C23A



CE \* UK CA \* \* For 50 to 200 kVA models only



Input/Output	Output capacity					
210 VAC 3-phase 3-wire	10 kVA (8 kW)	20 kVA (16 kW)	30 kVA (24 kW)	50 kVA (40 kW)	100 kVA (80 kW)	200 kVA (160 kW)

#### Dip compensation time

1 s

#### Dimensions [mm]

Output capacity [kVA]	Width	Height**	Depth	Mass
10	500	1525	700	230 kg
20				
30				
50 (CE)	750	1775	700	450 kg
				500 kg
100 (CE)	1050	1950	800	650 kg
				670 kg
200 (CE)	1550	2075		1100 kg
	1650			1200 kg

\*\* Support base height included

## Grid Management System Realizes microgrids

### SANUPS K23A M type



Input/Output	Output capacity		
200 VAC 3-phase 3-wire	20 kW	50 kW	100 kW

#### Dimensions [mm]

Output capacity [kW]	Width	Height*	Depth	Mass
20	500	1525	700	250 kg
50	800	1775	700	450 kg
100	1050	1950	800	700 kg

\* Support base height included

## Peak Cut Device Peak shaving system for reducing energy costs in factories

### SANUPS K33A



Input		Output	Max. output capacity
Rated voltage	Rated frequency		
380/400/415/420/440 VAC 3-phase 3-wire	50/60 Hz	Direct current	1800 kW

Contact us for dimensional and specification details.

## Inverter

Scalable, highly reliable inverter capable of parallel redundant operation

### SANUPS D11A



19-inch rack mountable



Input	Output	Output capacity		
		Single-unit operation	Parallel operation	Parallel redundant operation
48 VDC	100/120 VAC	1 kVA (1 kW)	2 to 6 kVA (2 to 6 kW)	1 to 5 kVA (1 to 5 kW)

Dimensions [mm]				
	Width	Height	Depth	Mass
Inverter unit	480	43.5	340.6	10 kg
Single-unit operation cabinet		450	10 kg	
3-unit parallel operation cabinet		177.5	410.6 (+38)	10 kg

Note: Contact us for the dimensions of UL/CE certified models.

## Static Transfer Switch

Constantly monitors two power sources and shifts from the main to spare without interruption

### SANUPS S11A

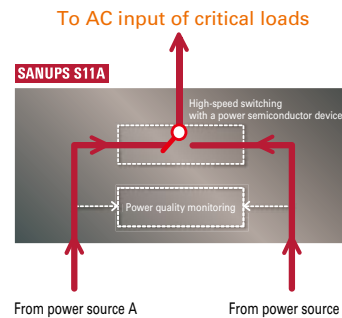

Input/Output	Rated current
100 VAC Single-phase 2-wire	30 A

Dimensions [mm]			
Width	Height	Depth	Mass
480	88	396	10 kg

## Networking Products

UPS Management Software

### SANUPS SOFTWARE

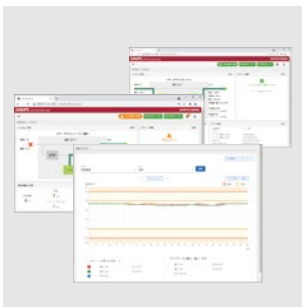

#### SANUPS SOFTWARE

Power management of multiple computers connected to a UPS can be implemented.

Model no.	
Windows version for download	PMS52□00DL
	PMS52□00DL-10 (10 licenses)
	PMS52□00DL-50 (50 licenses)
	PMS52□00DL-100 (100 licenses)
Windows version, CD-ROM	PMS52□01 (with cable)
	PMS53□00DL
Multi-OS* version for download	PMS53□00DL-10 (10 licenses)
	PMS53□00DL-50 (50 licenses)
	PMS53□00DL-100 (100 licenses)
	PMS53□01 (with cable)
Multi-OS* version, CD-ROM	PMS53□01 (with cable)

\* Windows, UNIX, and Linux

Note: The □ symbols denote revision characters. For the latest OS support information, see our website.

#### SANUPS SOFTWARE COMBINATION

Up to 1,000 UPS units can be remotely managed via a network.

Model no.	
Windows version	PMS42D00

Network Power Manager

### SANUPS T



Remotely manage and control the power of network equipment.

Input/Output	Rated current
100 VAC	15 A
200 to 240 VAC	10 A
200 to 240 VAC	20 A (10 A × 2 systems)

Dimensions [mm]			
Width	Height	Depth	Mass
430	46	205	3 to 4 kg

## PV Inverter

Grid-connected type

### SANUPS P73J



Certified by Japan Electrical Safety & Environment Technology Laboratories (JET)  
Registration no.: MP-0136 (9.9 kW model)  
MP-0135 (10 kW model)



Input operating voltage range	Rated output voltage	Rated output capacity
150 to 570 VDC	202 VAC 3-phase 3-wire	9.9/10 kW

- FRT
- IP65
- Output Control

Dimensions [mm]			
Width	Depth	Height	Mass
700	320	600	64 kg

Grid-connected isolated type

### SANUPS P73H



Input operating voltage range	Rated output voltage	Rated output capacity
150 to 600 VDC	202 VAC 3-phase 3-wire	10 kW

- FRT
- IP65
- Output Control

Dimensions [mm]			
Width	Depth	Height	Mass
700	320	600	62 kg

Grid-connected isolated charging type/Grid-connected isolated type

### SANUPS P73L



Input operating voltage range	Rated output voltage	Rated output capacity
150 to 570 VDC	202 VAC 3-phase 3-wire	10 to 60 kW

- FRT
- Output Control

Dimensions [mm]									
Grid-connected isolated charging type					Grid-connected isolated type				
Output capacity [kW]	Width	Depth	Height*	Mass	Output capacity [kW]	Width	Depth	Height*	Mass
10	650	650	950	190 kg	10	650	650	700	145 kg
20			1250	290 kg	20			1000	220 kg
30			1550	390 kg	30			1300	295 kg
40	1300	650	1250	580 kg	40	1300	1300	1000	440 kg
50			1550	705 kg	50			540 kg	
60			780 kg	60	590 kg				

\* Support base height (125 mm) not included

Grid-connected type/Grid-connected isolated type

### SANUPS P83E



Input operating voltage range	Rated output voltage	Rated output capacity
240 to 600 VDC	202 VAC 3-phase 3-wire	100 kW

- FRT
- Output Control

Dimensions [mm]				
	Width	Depth	Height	Mass
Grid-connected type	750	800	1950	880 kg
Grid-connected isolated type	1050			1030 kg

## Power Conditioner for Wind and Hydro Power Generation Systems

Grid-connected type/Grid-connected isolated type

### SANUPS W73A



Input operating voltage range	Rated output voltage	Rated output capacity
150 to 570 VDC	202 VAC 3-phase 3-wire	9.9 kW

IP65	Dimensions [mm]			
	Width	Depth	Height	Mass
	700	320	600	64 kg

## Remote Monitoring of PV Systems

### SANUPS PV Monitor



Dimensions [mm]			
Width	Height	Depth	Mass
220	43	153	1 kg

## PV System Status Monitoring Service

### SANUPS™ NET

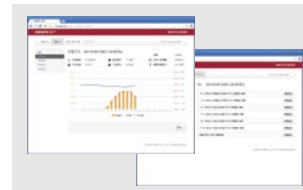

This service enables you to remotely monitor the status of photovoltaic power systems via the internet. It makes maintenance easier, providing long-lasting peace of mind.

## Emergency Diesel Generator

### SANUPS G53A



Rated output capacity	AC output	Continuous operation time
200/230 kVA (For 50/60 Hz)	200/220 V 3-phase 3-wire	2 hours or more

Dimensions [mm]			
Total length	Width	Height	Mass
4400	1200	2575	3500 kg

## Power Generation Vehicle

### SANUPS M53A



Vehicle model	Output circuit	Output capacity				[No. of phases/wires] Output voltage	
		At 3-phase		At single-phase		50 Hz	60 Hz
		50 Hz	60 Hz	50 Hz	60 Hz		
Van type	3-/single-phase switchable	20 kVA	25 kVA	11.5 kVA	14.4 kVA	200 V 3-phase 3-wire or 100/200 V single-phase 3-wire	220 V 3-phase 3-wire or 110/220 V single-phase 3-wire
		37 kVA	45 kVA	21.4 kVA	26 kVA		
Truck type	3-phase	100 kVA	125 kVA	—	—	210 V 3-phase 3-wire	210 V 3-phase 3-wire

## AC Servo Systems

### SANMOTION G



#### Servo amplifiers

**100 VAC :** 10 A, 20 A, 30 A

**200 VAC :** 10 A, 20 A, 30 A, 50 A

Analog/Pulse

EtherCAT®

#### Servo motors

Flange size	Rated output
40 mm	30 W, 50 W, 100 W, 150 W
60 mm	100 W, 200 W, 400 W, 600 W
80 mm	200 W, 400 W, 750 W, 1 kW
86 mm	750 W, 1 kW
100 mm	750 W, 1 kW, 1.5 kW
130 mm	550 W, 1.2 kW

**Encoder:** Battery-less absolute encoder and single-turn absolute encoder

### SANMOTION R *3E Model*



#### Servo amplifiers

Functional safety

**100 VAC:** 10 A, 20 A, 30 A

**200 VAC:** 10 A, 20 A, 30 A, 50 A, 75 A, 100 A, 150 A, 300 A, 600 A

Analog/Pulse

EtherCAT®

Built-in positioning function

#### Servo motors

Flange size	Rated output
40 mm	30 W, 50 W, 80 W, 90 W, 100 W
60 mm	100 W, 200 W, 360 W, 400 W
80 mm	200 W, 400 W, 750 W
86 mm	750 W, 1 kW
100 mm	750 W, 1 kW, 1.5 kW, 2 kW, 2.5 kW
130 mm	550 W, 1.2 kW, 1.8 kW, 2 kW, 3 kW, 4 kW, 5 kW
180 mm	3.5 kW, 4.5 kW, 5.5 kW, 7.5 kW, 11 kW, 15 kW
220 mm	5 kW, 7 kW, 11 kW, 15 kW, 20 kW, 21 kW
275 mm	30 kW

**Encoder:** Battery-less absolute encoder and single-turn absolute encoder



#### Servo amplifiers

Functional safety

**400 VAC:** 25 A, 50 A, 100 A, 150 A, 300 A, 800 A

Analog/Pulse

EtherCAT®

Built-in positioning function

#### Servo motors

Flange size	Rated output
100 mm	750 W, 1 kW, 1.5 kW, 2 kW
130 mm	550 W, 1.2 kW, 1.8 kW, 2 kW, 3 kW
180 mm	3.5 kW, 4.5 kW, 5.5 kW, 7.5 kW, 11 kW, 15 kW
220 mm	11 kW, 15 kW, 20 kW, 21 kW
275 mm	30 kW
320 mm	55 kW

**Encoder:** Battery-less absolute encoder and single-turn absolute encoder

## AC Servo Systems

# SANMOTION R ADVANCED MODEL



### Servo amplifiers

**48 VDC:** 25 A, 40 A

Single-axis:   Multi-axis:

### Servo motors

Flange size	Rated output
14 mm	2.4 W
20 mm	20 W, 30 W
40 mm	30 W, 50 W, 80 W, 100 W
60 mm	100 W, 200 W

**Encoder:** Battery-less absolute encoder and single-turn absolute encoder

## Linear Servo Motors



### Linear servo motors

Type	Magnet rail width	Rated thrust	Max. thrust
Dual magnet type with core	35 to 45 mm	610 to 800 N	1400 to 2200 N
Flat type with core	45 to 85 mm	140 to 340 N	270 to 700 N
Center magnet type with core	30 mm	350 N	650 N

**Compatible servo amplifiers:** SANMOTION G / R 3E Model, 200 VAC



### Compact cylinder linear servo motors

Motor width	Stroke length	Rated thrust	Max. thrust
12 mm	30 mm	5.1 N	16.5 N
20 mm	50 mm	15 N	50 N

**Compatible servo amplifier:** SANMOTION R ADVANCED MODEL, 48 VDC

SANMOTION multi-axis integrated linear servo motor unit that integrates multiple cylinder linear servo motors into a single unit is also available.

## AC Spindle Motors and AC Servo Amplifiers

# SANMOTION S



### Servo amplifiers

**200 VAC:** 150 A

### Spindle motors

Flange size	Rated output
160 mm	3.2 kW, 4.5 kW

## DC Servo Systems

### SANMOTION K



Servo motors	
Flange size	Rated output
42 mm	23 W, 40 W, 60 W
54 mm	60 W, 80 W, 110 W
76 mm	200 W, 300 W
88 mm	400 W, 500 W

## Closed Loop Stepping Systems

### SANMOTION Model No.PB



Drivers		
Type	Power supply	Input type
Type R	Single-phase 100 to 115 VAC	RS-485 + Parallel I/O
Type P	Single-/3-phase 200 to 230 VAC	Pulse input
Type M	24 / 48 VDC	RS-485 + Parallel I/O
Type R (Multi-axis)	24 / 36 VDC	Pulse input
Type P (Multi-axis)	24 / 48 VDC	RS-485 + Parallel I/O
Type E (Multi-axis)	24 / 48 VDC	Pulse input
		EtherCAT

Motors			
Compatible driver	Model	Motor size	Gear ratio
Type R Type P	Standard motor	42 mm, 60 mm, 86 mm	—
	Low backlash gear motor	42 mm, 60 mm	1:3.6, 1:7.2, 1:10, 1:20, 1:30
	Harmonic gear motor	42 mm, 60 mm	1:30, 1:50, 1:100
	Electromagnetic brake motor	42 mm, 60 mm	—
Type M Type R (Multi-axis) Type P (Multi-axis) Type E (Multi-axis)	Standard motor	28 mm, 42 mm, 60 mm	—
	Low backlash gear motor	42 mm, 60 mm	1:3.6, 1:7.2, 1:10, 1:20, 1:30
	Harmonic gear motor	28 mm, 42 mm, 60 mm	1:30, 1:50, 1:100
	Electromagnetic brake motor	28 mm, 42 mm, 60 mm	—

**Encoder:**  
Battery-less absolute encoder (for 42 mm and 60 mm motors with a Type E driver only) and incremental encoder



## 2-Phase Stepping Systems

# SANMOTION F2



### Drivers

**24/36 VDC** Unipolar and bipolar

Pulse input

### Stepping motors

Motor size	Full step angle	Remarks
14 mm	1.8°	Only bipolar available
28 mm	1.8°	
35 mm	1.8°	Only unipolar available
42 mm	1.8°, 0.9°	
50 mm	1.8°	
56 mm	1.8°	
60 mm	1.8°, 0.9°	
86 mm	1.8°	
ø106 mm	1.8°	

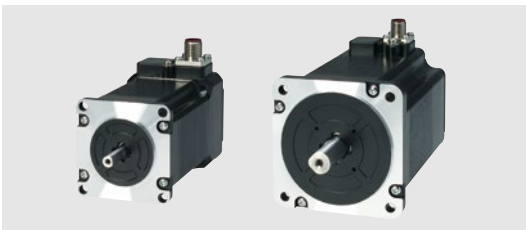

### IP65-rated stepping motors

Waterproof and Dustproof

Motor size	Full step angle	Remarks
56 mm	1.8°	Only bipolar available
86 mm	1.8°	

## 3-Phase Stepping Systems

# SANMOTION F3



### Stepping motors

Motor size	Full step angle
42 mm	1.2°
50 mm	1.2°
56 mm	1.2°
60 mm	1.2°

## 5-Phase Stepping Systems

# SANMOTION F5



### Drivers

#### Pulse input

Driver	Power supply	Remarks
AC input driver	100 to 120 VAC, 200 to 240 VAC	Microstep
DC input driver	24/36 VDC	Microstep, full/half-step

### Stepping motors

Motor size	Full step angle
28 mm	0.72°
42 mm	
50 mm	
60 mm	
86 mm	

### Set orders

Compatible driver	Model	Motor size	Gear ratio
AC input driver	Standard motor	42 mm, 60 mm, 86 mm	—
	CE/UL-certified motor	42 mm, 60 mm, 86 mm	—
	Low backlash gear motor	42 mm, 60 mm, 86 mm	1:3.6, 1:7.2, 1:10, 1:20, 1:30, 1:36
	Harmonic gear motor	42 mm, 60 mm, 86 mm	1:30, 1:50, 1:100
	Electromagnetic brake motor	42 mm, 60 mm, 86 mm	—
DC input driver	Standard motor	28 mm, 42 mm, 60 mm, 86 mm	—
	Low backlash gear motor	42 mm, 60 mm, 86 mm	1:3.6, 1:7.2, 1:10, 1:20, 1:30, 1:36
	Harmonic gear motor	28 mm, 42 mm, 60 mm, 86 mm	1:30, 1:50, 1:100
	Electromagnetic brake motor	42 mm, 60 mm, 86 mm	—



### Linear actuator stepping motors

A stepping motor and ball screw are integrated into one compact unit.

Motor size	Rated current	Stroke length	Thrust
42 mm	0.75 A/Phase	50 mm	370 N
60 mm	1.4 A/Phase	80 mm	450 N

Available with or without brake

## Motion Controller

# SANMOTION C S100



Model no.	SMC100-A	SMC100-B
Interface	EtherCAT (100 Mbps) master function, FoE-compatible Ethernet (10/100/1000 Mbps) protocols (Modbus TCP, OPC-UA) RS-485 (9600 to 115200 bps) USB 2.0 (for memory storage)	
Digital I/O	Digital input: 16 points; rated input voltage: 24 VDC; positive/negative common input Digital output: 8 points; load voltage range: 19.2 to 30 VDC; maximum load current: 0.5 A/point; sink output	
Input power supply	Rated voltage: 24 VDC (main power supply, I/O power supply)	
Max. no. of controllable axes	8	
Control functions	Sequence control Motion control Robot control	Sequence control Motion control (PTP control)
Control language	Programming languages as per IEC 61131-3 G-code (SMC100-A only)	
Dimensions (W × H × D)	55 × 120 × 110 mm	

# SANMOTION C S500



Model no.	SMC520	SMC507	SMC505
Interface	EtherCAT (100 Mbps) master function Ethernet (10/100/1000 Mbps) protocols (Modbus TCP, OPC-UA) - USB 3.0 /2.0		
Input power supply	24 VDC (19.2 to 33 VDC)		
Max. no. of controllable axes	64		
Robot communication cycle	1 ms or more	2 ms or more	4 ms or more
Max. controllable robot	4	2	1
Control functions	Sequence control Motion control Robot control (can calculate kinematics such as cartesian, delta, SCARA, palletizing, and 6-/7-axis articulated robots)		
Control language	Sequence/motion control: Programming languages as per IEC 61131-3 Robot control: Original language		
Dimensions (W × H × D)	124.2 × 161.2 × 94 mm	126.5 × 83.6 × 94.9 mm	



## Peripherals

### Wireless Adapter 3A

Model no.	SMC-USBW-01	
Basic specifications	Dimensions (W × H × D)	21.8 × 11.5 × 56.5 mm
	Interface	USB 2.0 Type A
	Use with	SANMOTION C S100 motion controllers only
Functions	Wireless standard	Compliant with IEEE802.11b/IEEE802.11g/IEEE802.11n
	Operating frequency band	2.4 GHz band
	Channels	1 to 13 ch
	Maximum communication speed	72.2 Mbps
	Wireless LAN mode	Access point mode (Acting as a master network station) Station mode (Acting as a slave network station)
	Maximum number of connectable units	3 (in access point mode)
Security	WPA2-PSK (AES)	