

NOTES:

1. MATERIAL AND FLAMMABILITY.
POLYCARBONATE (LIGHT GRAY AND CLEAR) - UL94-HB
BODY, COVER AND CLEAR COVER (C)
FLAMMABILITY RATING (UL FILE #E41613)
SERVICE TEMPERATURE RANGE: -40°C TO +120°C
2. UL 508A (E352997) UL CERT OF COMPLIANCE.: BOXES UL LISTED
NEMA TYPE 6P STANDARD. DESIGNED MEETS IP68 OF IEC529
REQUIREMENTS. PC VERSION UV RESISTANT FOR OUT DOOR USE.
3. GASKET (NOT INSTALLED) MOLDED SILICONE WHITE
4. DIMENSIONS ARE INCH

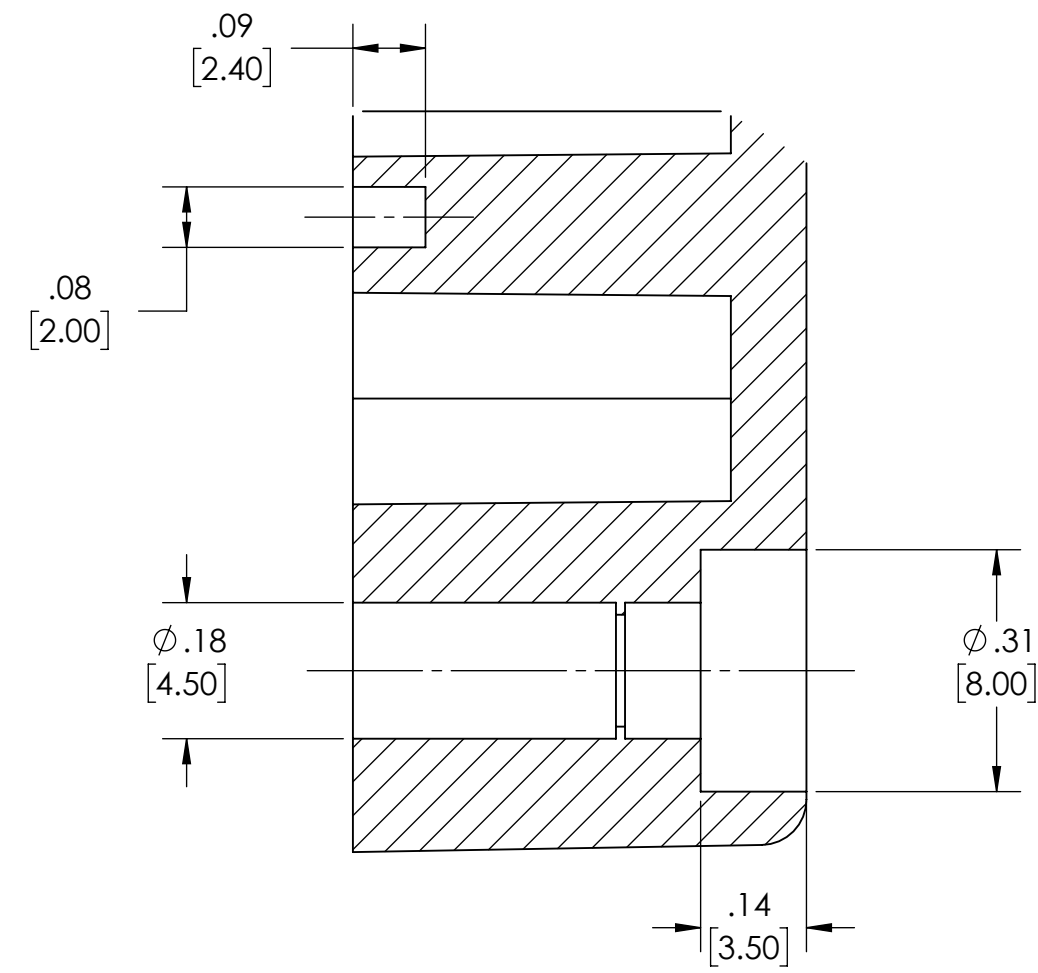

DETAIL C
SCALE 4 : 1

GASKET (NOT INSTALLED)
MOLDED SILICONE WHITE

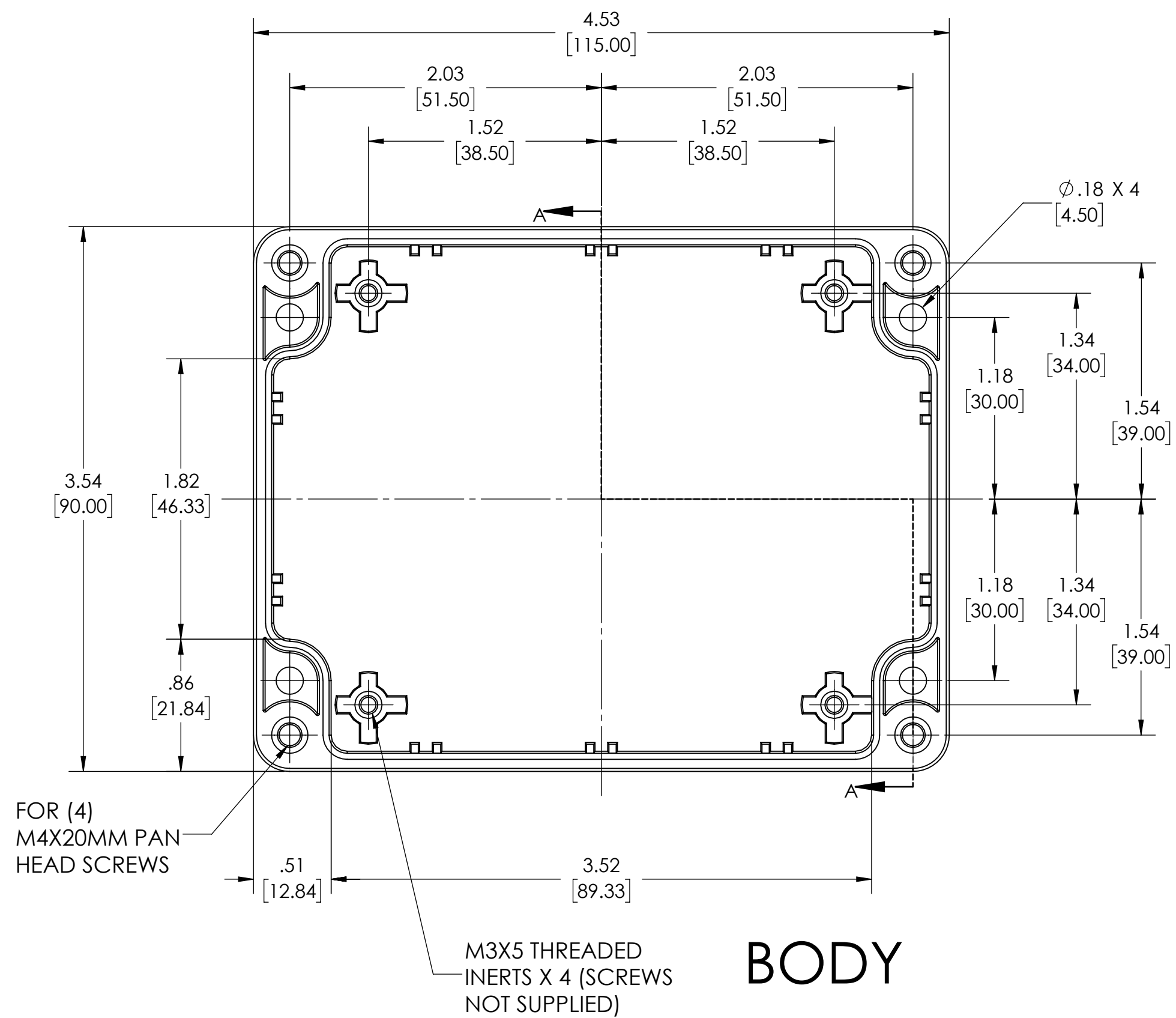
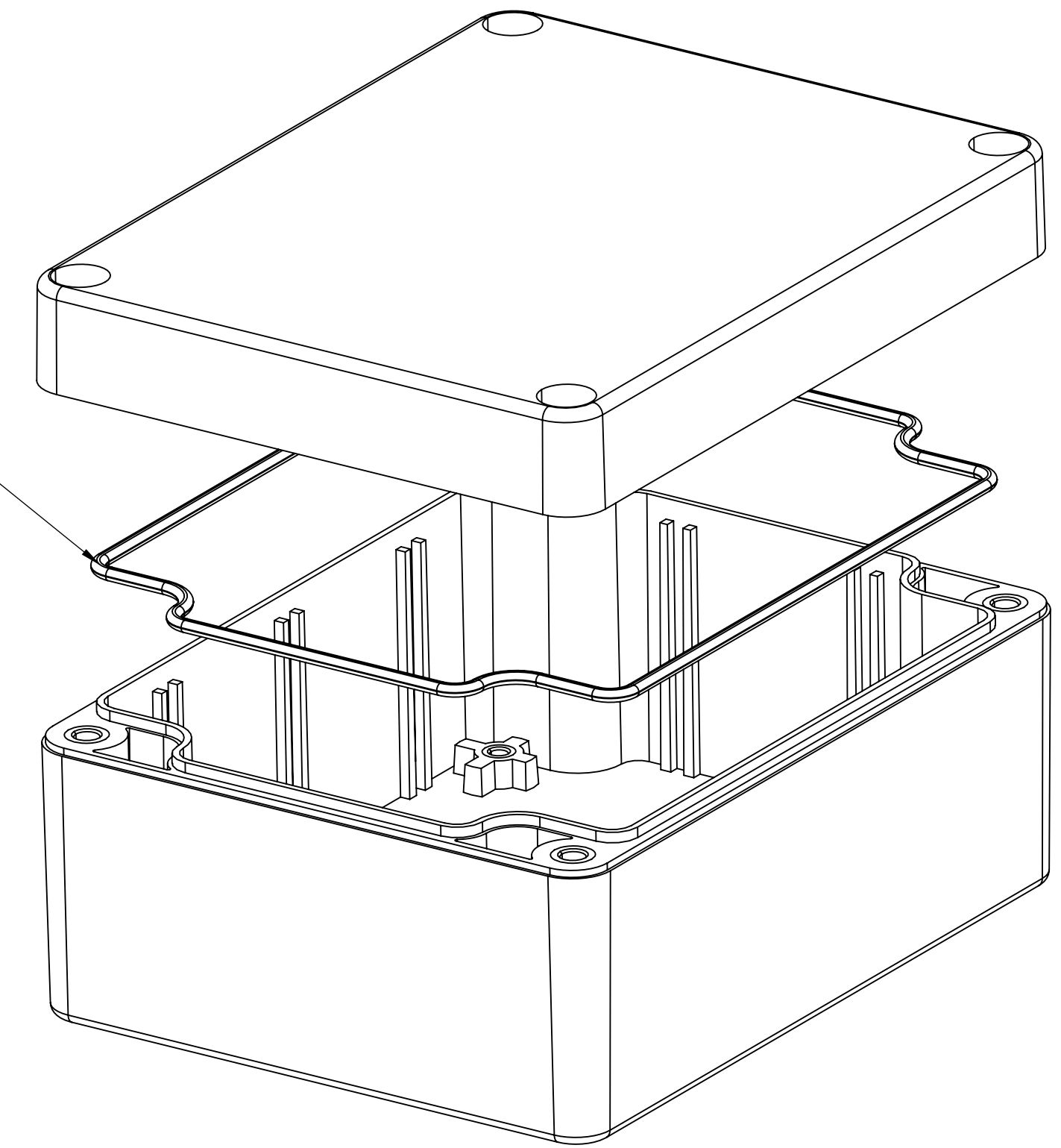

BODY

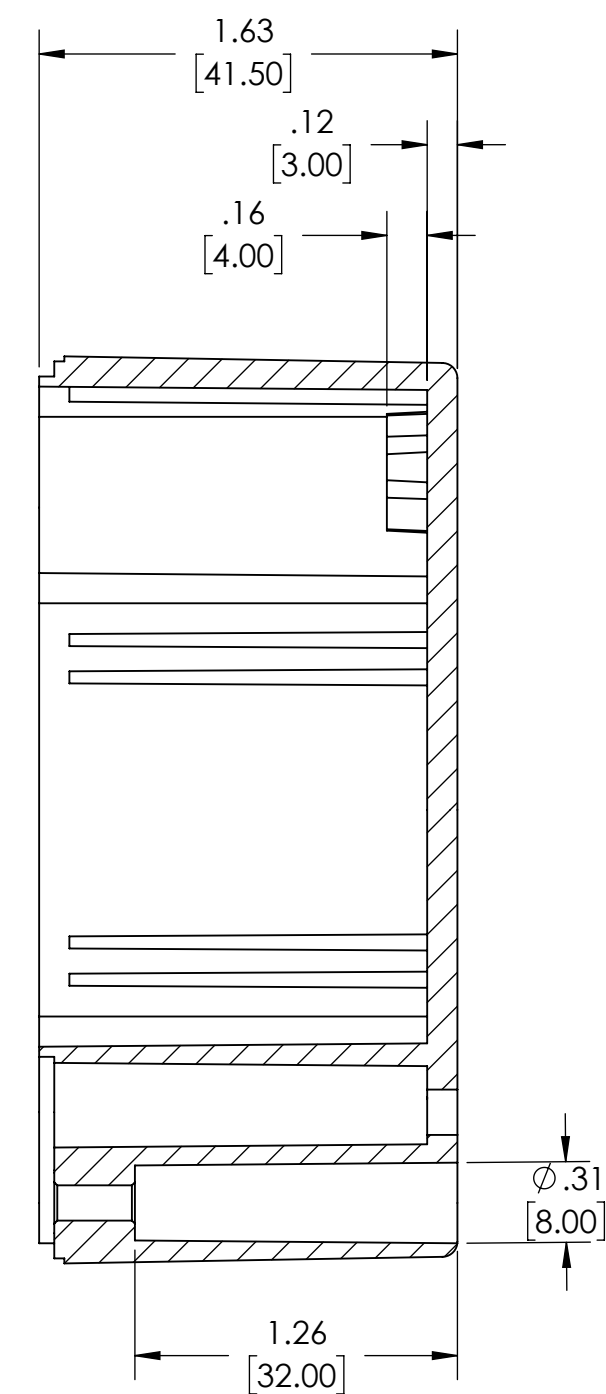

SECTION A-A
SCALE 1 : 0.75

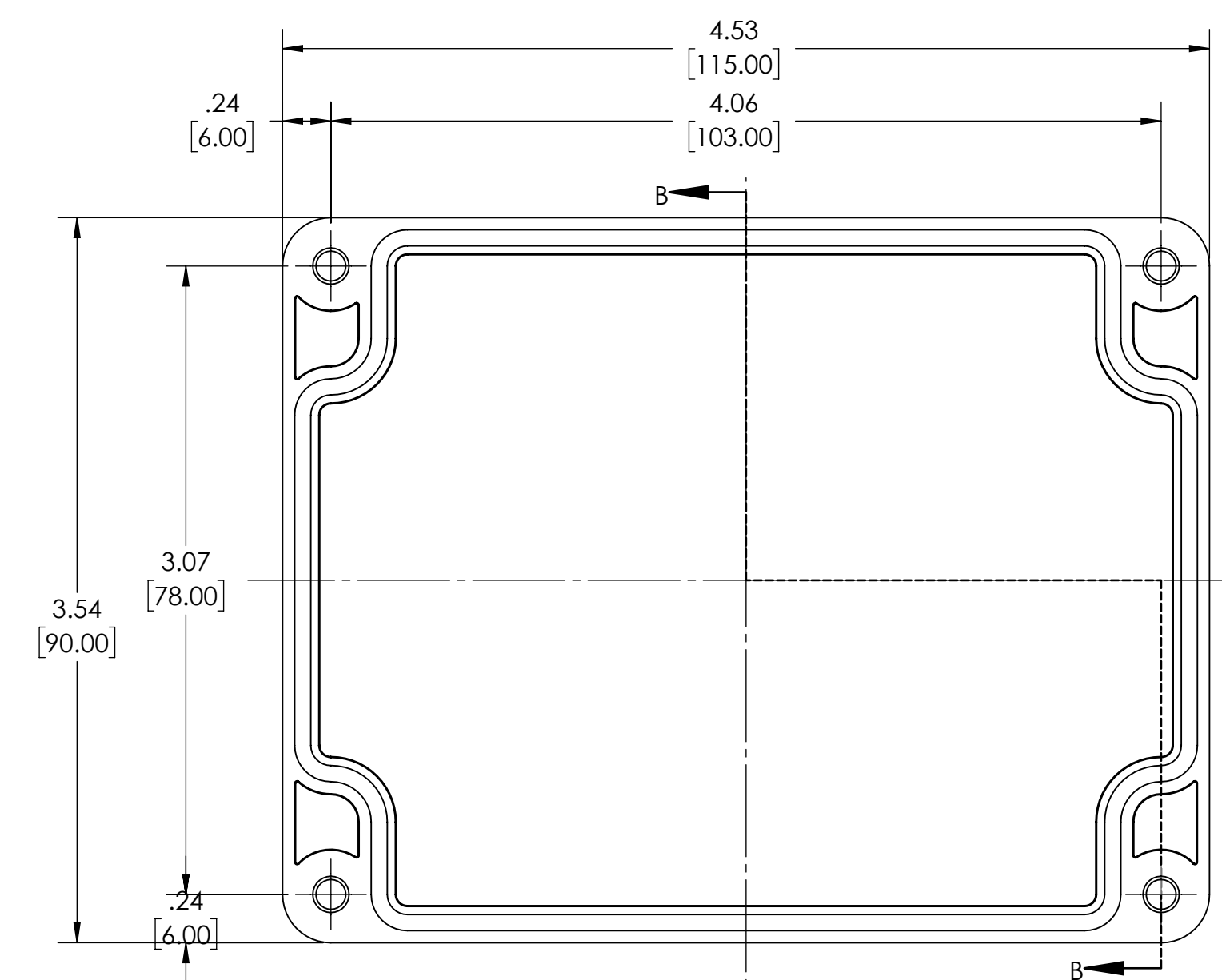

COVER

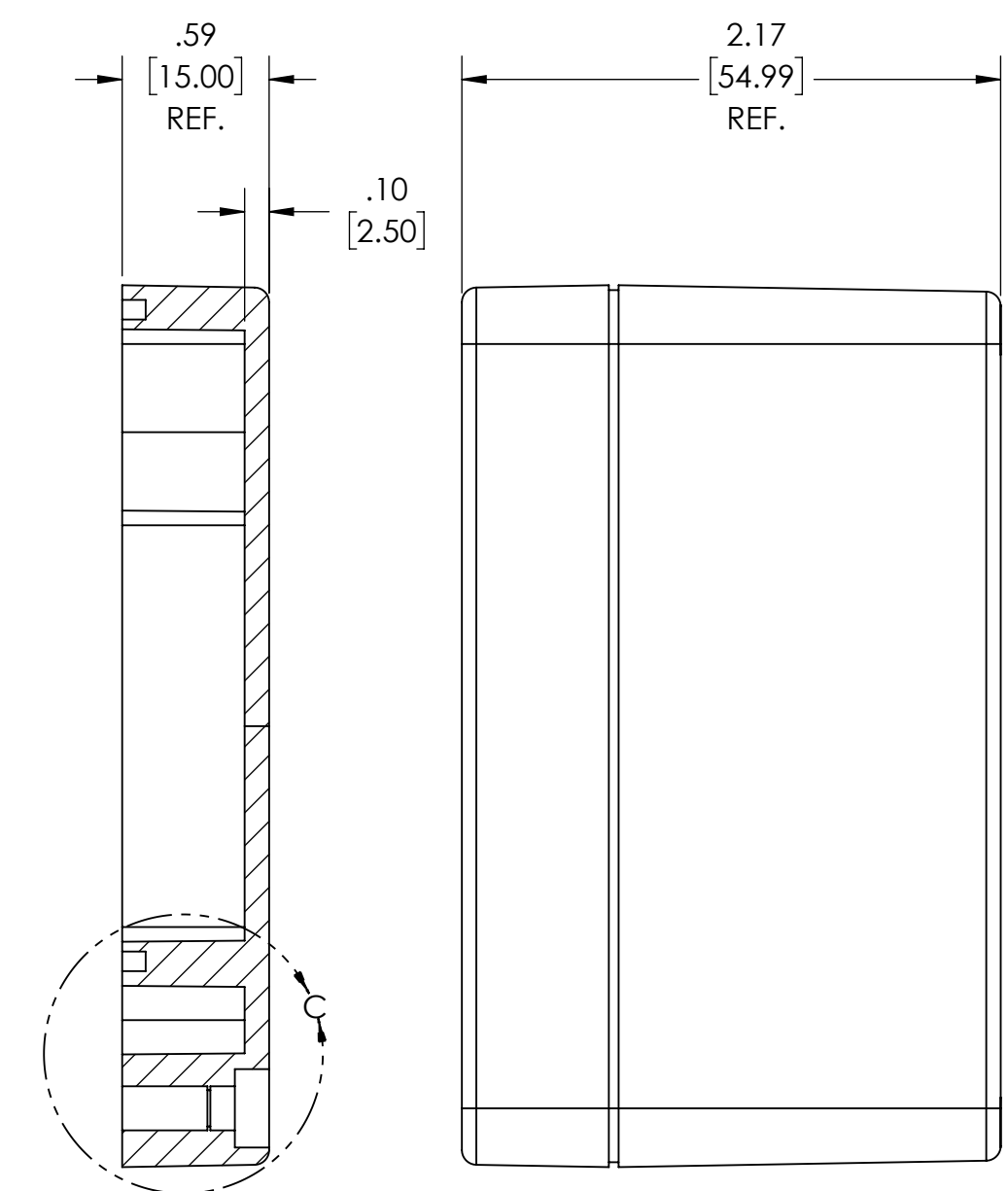

SECTION B-B
SCALE 1 : 0.75

DRAWING FOR REFERENCE
WE RESERVE THE RIGHT TO MAKE CHANGES TO OUR
STANDARD PRODUCTS. PLEASE CONSULT WITH BUD INDUSTRIES
PRIOR TO USING THIS DRAWING FOR DESIGN PURPOSE.