

NOTES:

1. MATERIAL AND FLAMMABILITY.  
POLYCARBONATE (LIGHT GRAY AND CLEAR) - UL94-HB  
BODY, COVER AND CLEAR COVER (C)  
FLAMMABILITY RATING (UL FILE #E41613)  
SERVICE TEMPERATURE RANGE: -40 °C TO +120 °C
2. UL 508A (E352997) UL CERT OF COMPLIANCE.: BOXES UL LISTED  
NEMA TYPE 6P STANDARD. DESIGNED MEETS IP68 OF IEC529  
REQUIREMENTS. PC VERSION UV RESISTANT FOR OUT DOOR USE.
3. GASKET (NOT INSTALLED) MOLDED SILICONE WHITE
4. DIMENSIONS ARE INCH

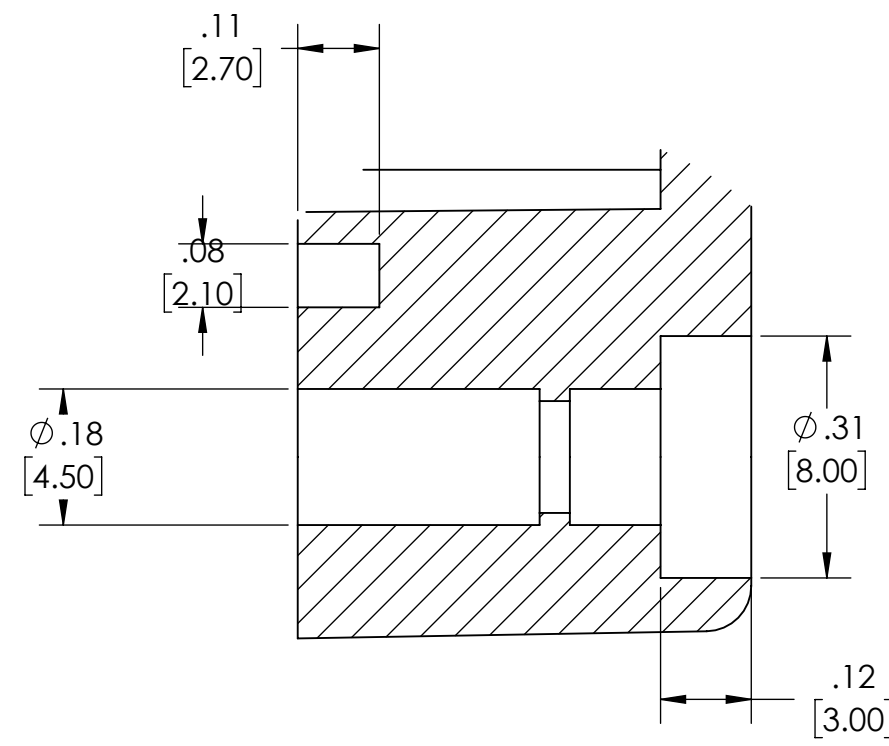

DETAIL C  
SCALE 4 : 1

GASKET (NOT INSTALLED)  
MOLDED SILICONE WHITE

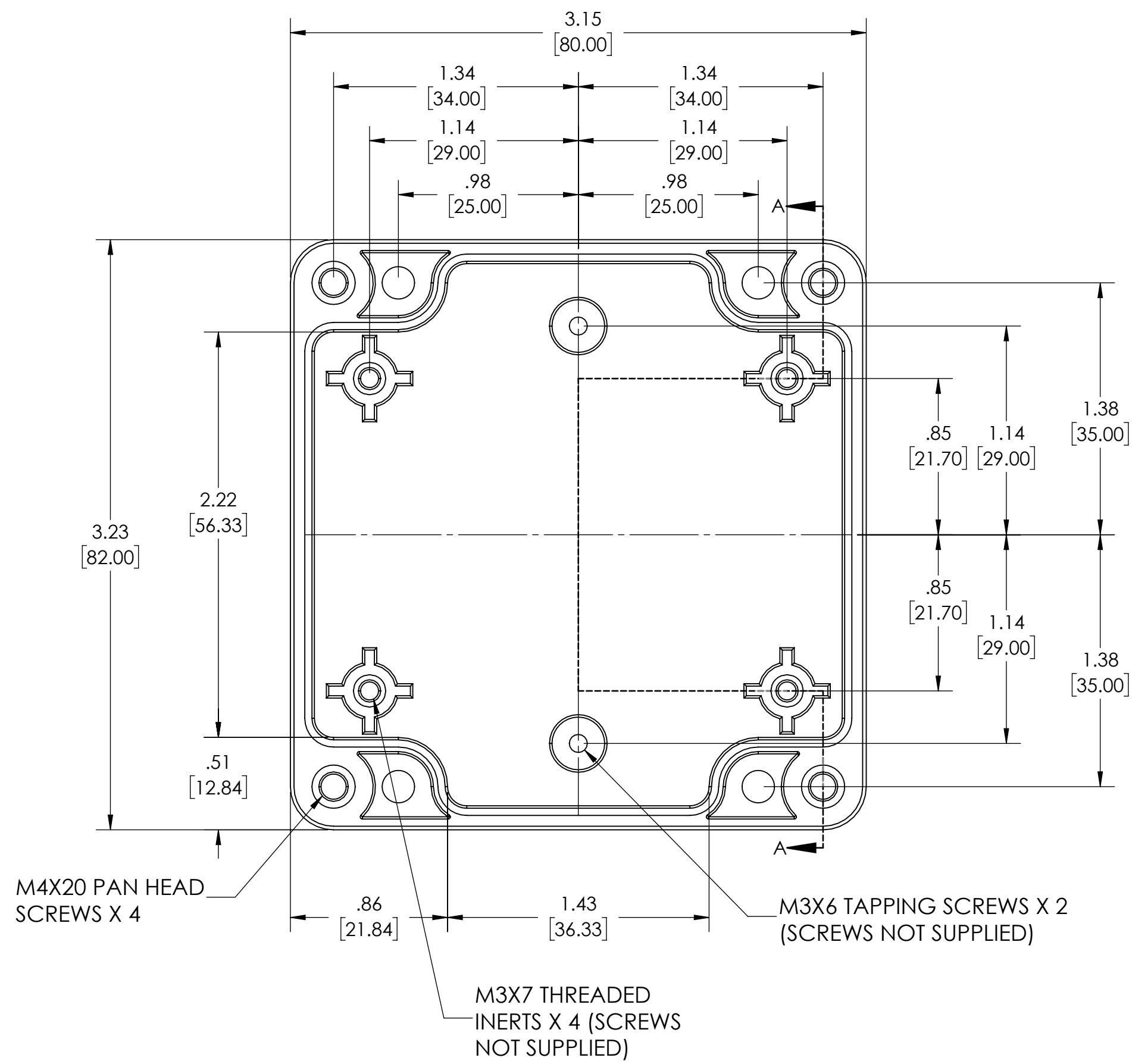
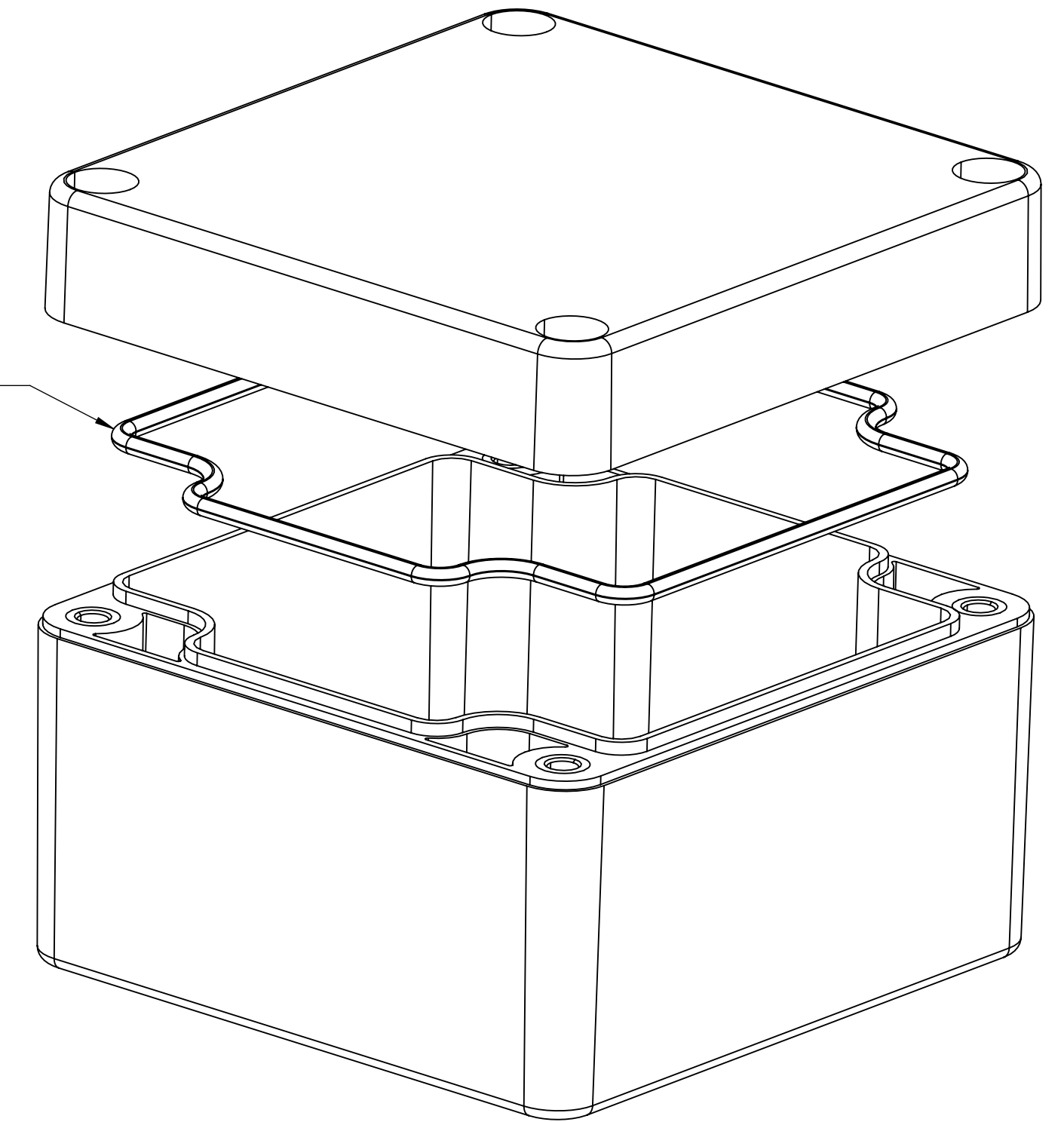

BODY

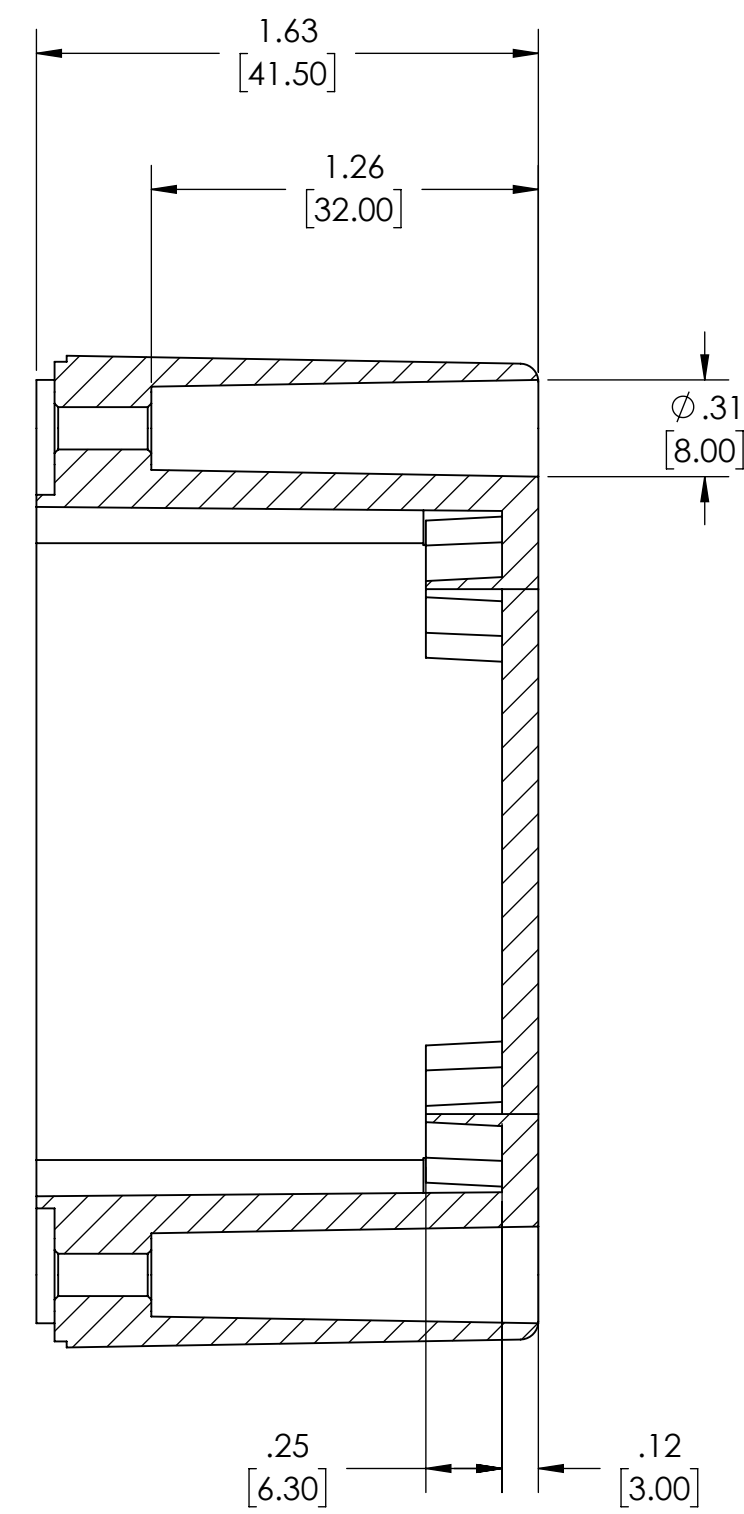

SECTION A-A  
SCALE 2 : 1.25

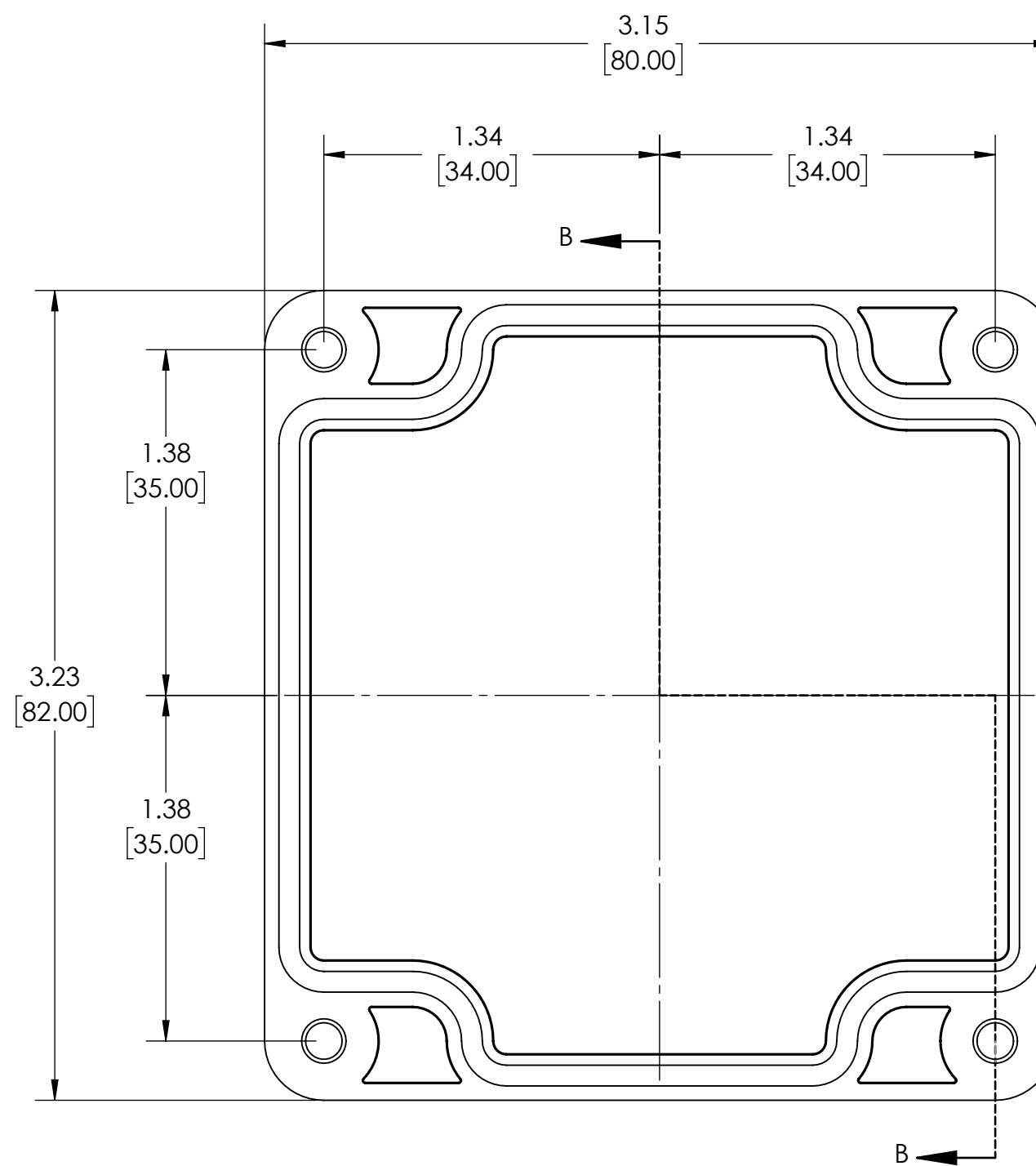

COVER

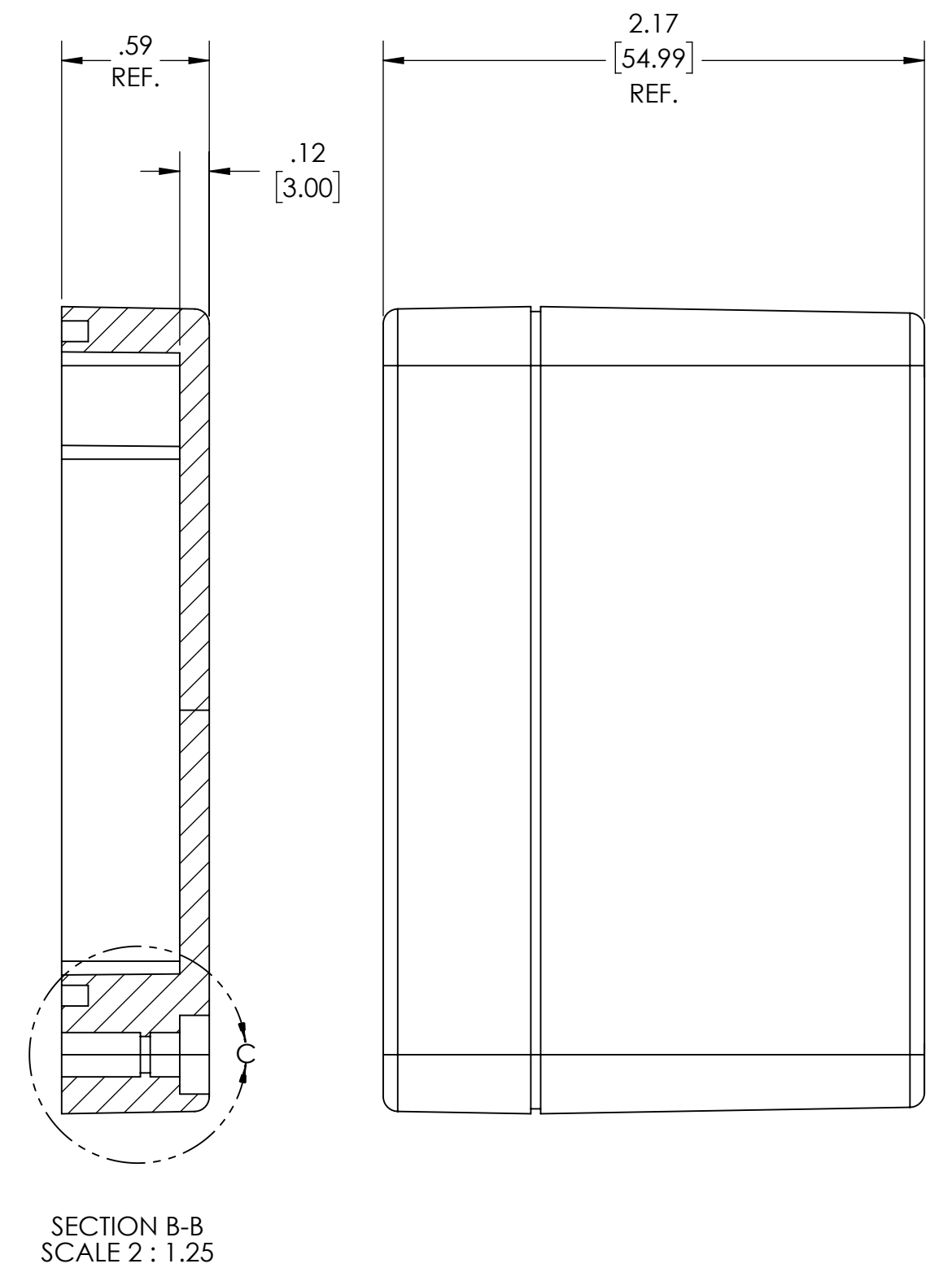

SECTION B-B  
SCALE 2 : 1.25

**DRAWING FOR REFERENCE**  
WE RESERVE THE RIGHT TO MAKE CHANGES TO OUR  
STANDARD PRODUCTS. PLEASE CONSULT WITH BUD INDUSTRIES  
PRIOR TO USING THIS DRAWING FOR DESIGN PURPOSE.