

Slide Potentiometer

Model PSxxM / PSxxL



Features:

- Molded element
- 100,000 cycle life
- Metal or plastic shaft options
- With/without LED illumination
- With/without dust cover
- RoHS compliant

Model Styles Available

| | |
|-----------------------|-------|
| Dual Gang Without LED | PSxxM |
| Single Gang With LED | PSxxL |

Electrical

| | |
|---|---|
| Resistance Range, Ohms | 500 -1M |
| Standard Resistance Tolerance | ± 20% |
| Resistance Tapers | A,B,C |
| Residual Resistance | Terminals 1 to 2: Less than 10 ohms Terminals 2 to 3: Less than 30 ohms |
| Input Voltage, Maximum | Linear B taper: 200 Vac Other tapers: 150 Vac |
| Power rating, Watts (Single Unit / Dual Unit) | Linear B taper: 20mm: 0.1W / 0.05W, 30mm: 0.2W / 0.1W 45mm: 0.25W / 0.125W, 60mm: 0.2W / 0.2W Other tapers: 20mm: 0.05W / 0.025W, 30mm: 0.1W / 0.05W 45mm: 0.125W / 0.06W, 60mm: 0.1W / 0.1W |
| Dielectric Strength | 300Vac, 1 minute |
| Insulation Resistance, Minimum | 10M ohms at 250Vdc/ 1 minute |
| Sliding Noise | Less than 100mV |
| Gang Error | ±3dB (-40dB to 0dB) |

Mechanical

| | |
|-------------------------------|---------------|
| Static Stop Strength, Minimum | 5.0 Kg/cm |
| Operating Force | 10gf to 100gf |
| Detent Slip-out force | 30gf to 200gf |

Durability

| | |
|--------------|----------------|
| Sliding Life | 100,000 cycles |
|--------------|----------------|

General Note
TT Electronics reserves the right to make changes in product specification without notice or liability. All information is subject to TT Electronics' own data and is considered accurate at time of going to print.

TT Electronics | BI Technologies
Circulo de la Amistad #102 PIMSA IV Mexicali B.C. Mexico C.P 21210
Ph: +1 714 447 2345
www.ttelectronics.com/bi-technologies

Slide Potentiometer

Model PSxxM / PSxxL



Ordering

Model PSxxM (Without LED)

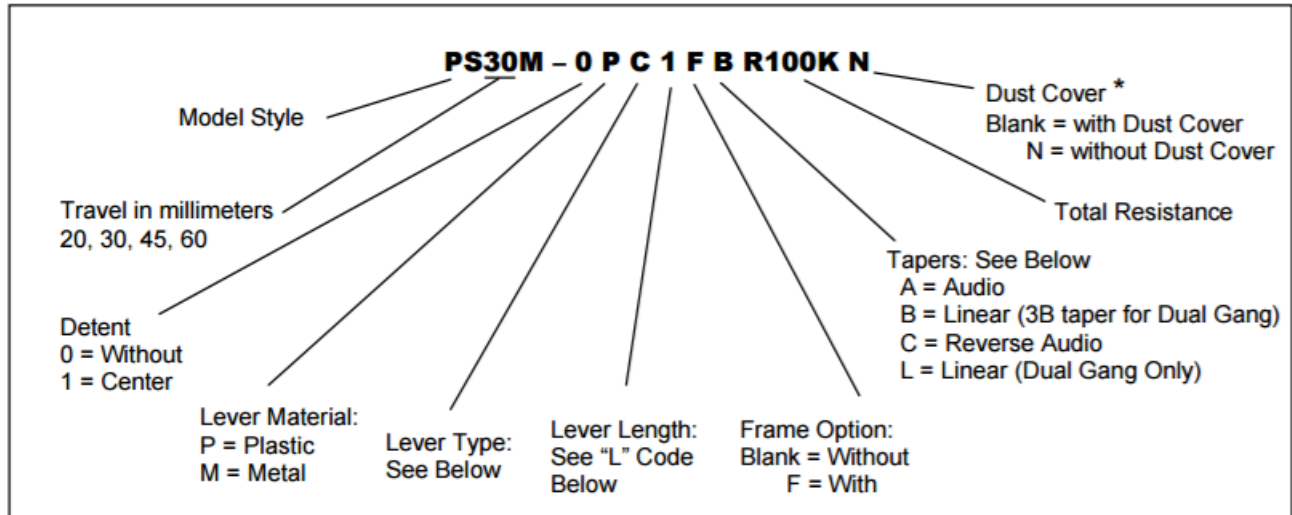

Model PSxxL (With LED)

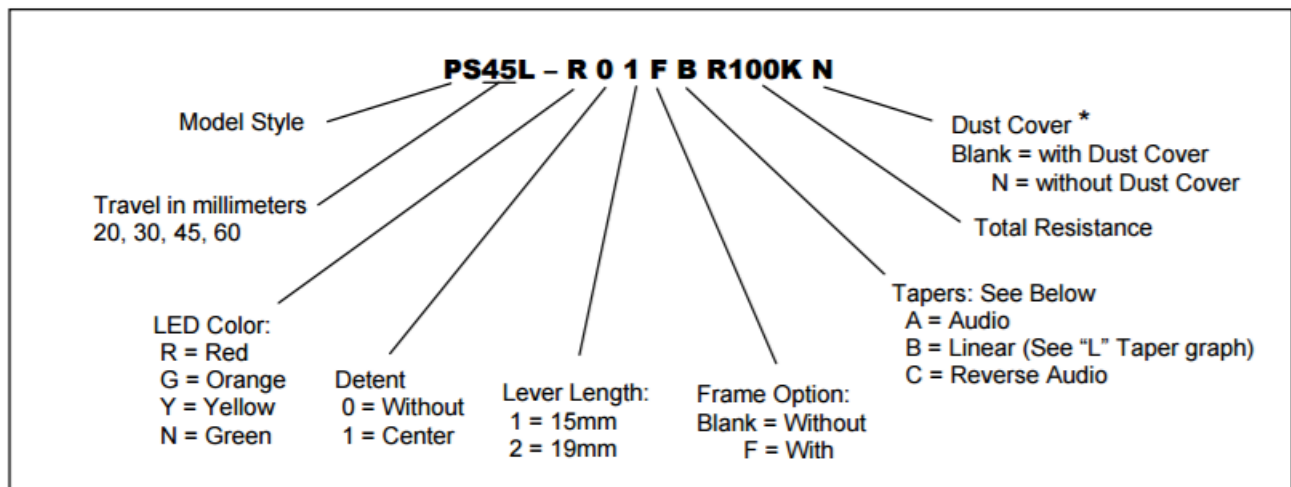

Standard Resistance Values, ohms

| | | | | | | | | | | |
|-----|----|----|----|-----|-----|-----|------|------|------|-------|
| 500 | 1K | 2K | 5K | 10K | 20K | 50K | 100K | 200K | 500K | 1 MEG |
|-----|----|----|----|-----|-----|-----|------|------|------|-------|

Slide Potentiometer

Model PSxxM / PSxxL



Tapers

For Dual Gang units ONLY, the Standard Taper is a 3B taper
If Linear Taper is desired, use "L" taper option

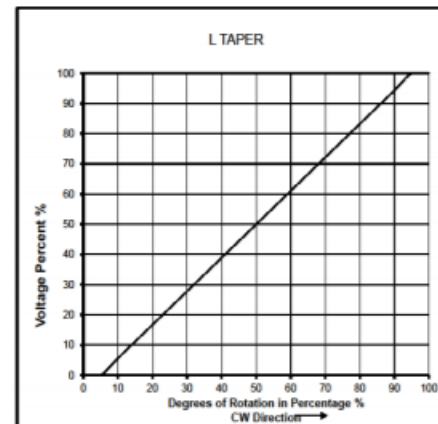
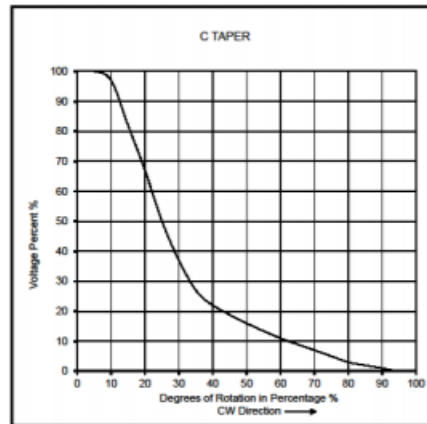
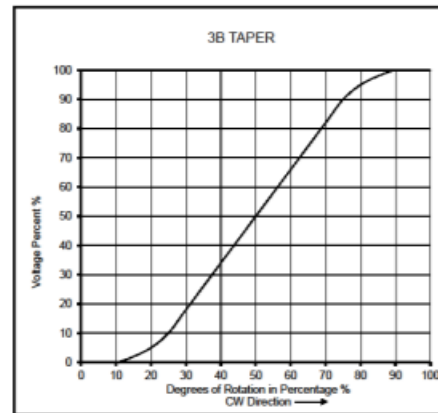
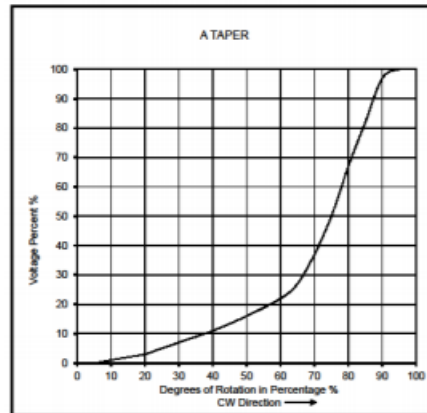

General Note

TT Electronics reserves the right to make changes in product specification without notice or liability. All information is subject to TT Electronics' own data and is considered accurate at time of going to print.

Outline Drawings

Plastic Lever Types (For PSxxM Only)

| E-Type | | B-Type | | C-Type | | D-Type | |
|--------|-----|--------|----|--------|-------|--------|-------|
| | | | | | | | |
| L | 5.0 | L | 15 | L | 10 15 | L | 10 15 |
| CODE | 1 | CODE | 1 | CODE | 1 2 | CODE | 1 2 |

Dust Cover option not offered for levers less than 10 mm in length

Metal Lever Types (For PSxxM Only)

| D-Type | | | | C-Type | | | |
|--------|----|----|----|--------|----|----|----|
| | | | | | | | |
| L | 15 | 20 | 25 | F | 5 | 10 | 10 |
| CODE | 1 | 2 | 3 | L | 10 | 15 | 20 |
| | | | | CODE | 1 | 2 | 3 |
| | | | | | | | 4 |

*** Dust Cover option not offered for levers less than 10 mm in length**

Slide Potentiometer

Model PSxxM / PSxxL



Outline Drawings

Model PSxxM (Without LED)

With Dust Cover

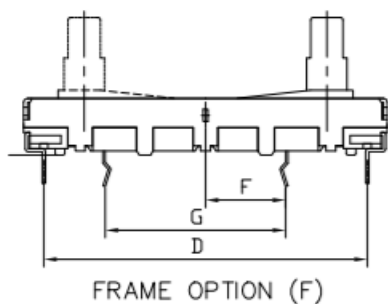
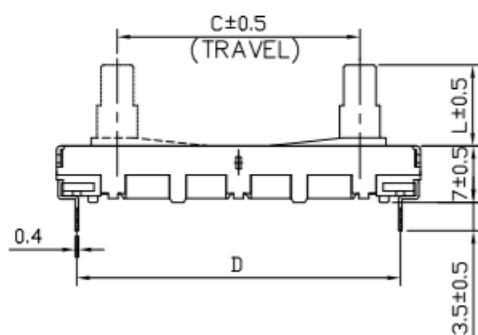
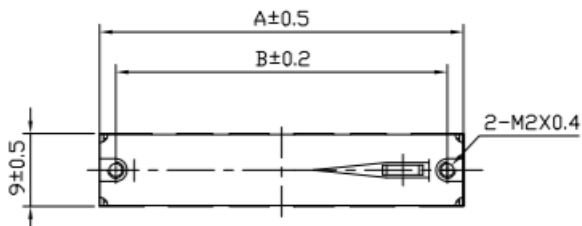

Without Dust Cover

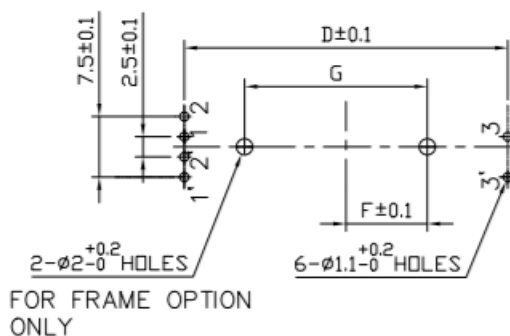
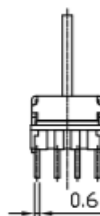
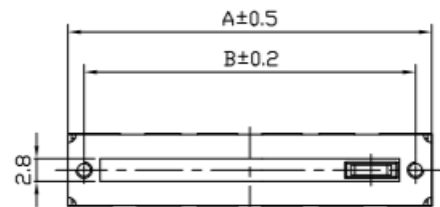

For PSxxM and PSxxL

| MODEL | A | B | C | D | F | G |
|-------------|----|----|----|----|------|------|
| PS20M PS20L | 35 | 31 | 20 | 30 | 5 | 12.5 |
| PS30M PS30L | 45 | 41 | 30 | 40 | 10 | 22.5 |
| PS45M PS45L | 60 | 56 | 45 | 55 | 15 | 32.5 |
| PS60M PS60L | 75 | 71 | 60 | 70 | 22.5 | 47.5 |

General Note
 TT Electronics reserves the right to make changes in product specification without notice or liability. All information is subject to TT Electronics' own data and is considered accurate at time of going to print.

TT Electronics | BI Technologies
 Circulo de la Amistad #102 PIMSA IV Mexicali B.C. Mexico C.P 21210
 Ph: +1 714 447 2345
www.ttelectronics.com/bi-technologies