

# PS2533-1, PS2533L-1

R08DS0198EJ0100

Rev.1.00

HIGH COLLECTOR TO EMITTER VOLTATGE HIGH ISOLATION VOLTAGE

Dec 25, 2020

## DESCRIPTION

The PS2533-1 and PS2533L-1 are optically coupled isolator containing a GaAs light emitting diode and an NPN silicon darlington connected phototransistor.

The PS2533-1 is in a plastic DIP (Dual In-line Package) and the PS2533L-1 is lead bending type (Gull-wing) for surface mount.

## FEATURES

- High collector to emitter voltage ( $V_{CEO} = 350 \text{ V}$ )
- High isolation voltage ( $BV = 5\,000 \text{ Vr.m.s.}$ )
- High current transfer ratio ( $CTR = 4\,000 \%$  TYP.)
- High-speed switching ( $t_r, t_f = 100 \mu\text{s}$  TYP.)
- Ordering number of taping product: PS2533L-1-F3 : 2 000 pcs/reel
- Pb-Free product
- Safety standards
  - UL approved: UL1577, Double protection
  - CSA approved: CAN/CSA-C22.2 No. 62368-1, Reinforced insulation
  - BSI approved: BS EN 62368-1, Reinforced insulation
  - SEMKO approved: EN 62368-1, IEC 62368-1, Reinforced insulation
  - NEMKO approved: EN 62368-1, Reinforced insulation
  - FIMKO approved: EN 62368-1, Reinforced insulation
  - DEMKO approved: EN 62368-1, Reinforced insulation
  - VDE approved: DIN EN 60747-5-5 (Option)

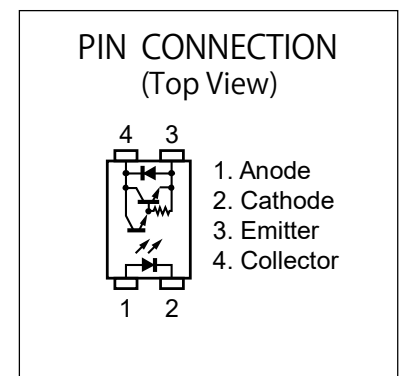

## APPLICATIONS

- Telephone, Exchange equipment
- FAX/MODEM



## MARKING EXAMPLE

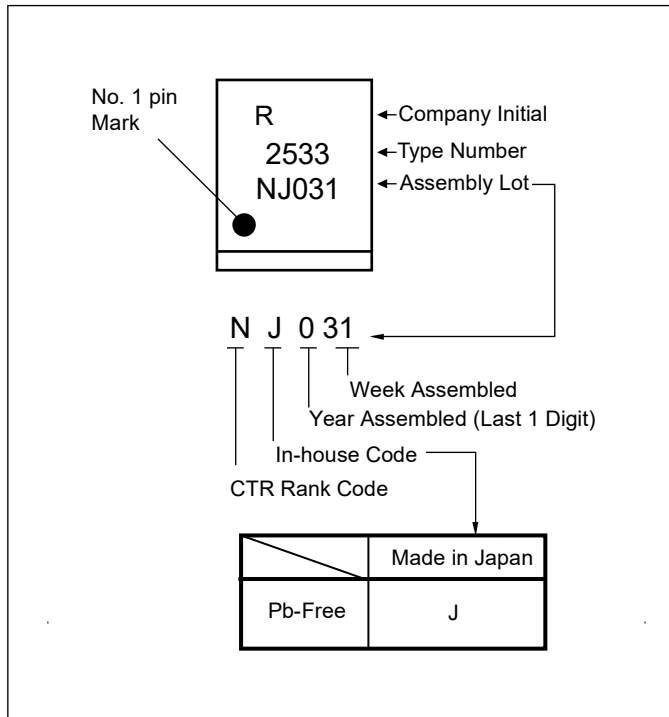

## ORDERING INFORMATION

Part Number	Order Number	Solder Plating Specification	Packing Style	Safety Standard Approval	Application Part Number *1
PS2533-1	PS2533-1-A	Pb-Free	Magazine case 100 pcs	Standard products (UL, CSA, BSI, SEMKO, NEMKO, DEMKO, FIMKO approved)	PS2533-1
PS2533L-1	PS2533L-1-A		Embossed Tape 2 000 pcs/reel		PS2533L-1
PS2533L-1-F3	PS2533L-1-F3-A				PS2533L-1
PS2533-1-V	PS2533-1-V-A		Magazine case 100 pcs	UL, CSA, BSI, SEMKO, NEMKO, FIMKO, DEMKO, DIN EN 60747-5-5 approved	PS2533-1
PS2533L-1-V	PS2533L-1-V-A		Embossed Tape 2 000 pcs/reel		PS2533L-1
PS2533L-1-V-F3	PS2533L-1-V-F3-A				PS2533L-1

Notes: \*1. For the application of the Safety Standard, following part number should be used.

**ABSOLUTE MAXIMUM RATINGS (T<sub>A</sub> = 25 °C, unless otherwise specified)**

Parameter		Symbol	Ratings	Unit
Diode	Forward Current (DC)	I <sub>F</sub>	80	mA
	Reverse Voltage	V <sub>R</sub>	6	V
	Power Dissipation Derating	ΔP <sub>D</sub> /°C	1.5	mW/°C
	Power Dissipation	P <sub>D</sub>	150	mW
	Peak Forward Current*1	I <sub>FP</sub>	1	A
Transistor	Collector to Emitter Voltage	V <sub>CEO</sub>	350	V
	Emitter to Collector Voltage	V <sub>ECO</sub>	0.6	V
	Collector Current	I <sub>C</sub>	150	mA
	Power Dissipation Derating	ΔP <sub>C</sub> /°C	3.0	mW/°C
	Power Dissipation	P <sub>C</sub>	300	mW
Isolation Voltage*2		BV	5 000	Vr.m.s.
Operating Ambient Temperature		T <sub>A</sub>	-55 to +100	°C
Storage Temperature		T <sub>stg</sub>	-55 to +150	°C

Note: \*1. PW = 100 μs, Duty Cycle = 1 %

\*2. AC voltage for 1 minute at T<sub>A</sub> = 25 °C, RH = 60 % between input and output.

Pins 1-2 shorted together, 3-4 shorted together.

**ELECTRICAL CHARACTERISTICS (T<sub>A</sub> = 25 °C)**

	Parameter	Symbol	Conditions	MIN.	TYP.	MAX.	Unit
Diode	Forward Voltage	V <sub>F</sub>	I <sub>F</sub> = 10 mA		1.15	1.40	V
	Reverse Current	I <sub>R</sub>	V <sub>R</sub> = 5 V			5	μA
	Terminal Capacitance	C <sub>t</sub>	V = 0 V, f = 1.0 MHz		30		pF
Transistor	Collector to Emitter Dark Current	I <sub>CEO</sub>	V <sub>CE</sub> = 350 V, I <sub>F</sub> = 0 mA			400	nA
Coupled	Current Transfer Ratio (I <sub>c</sub> /I <sub>F</sub> )	CTR	I <sub>F</sub> = 1 mA, V <sub>CE</sub> = 2 V	1 500	4 000	6 500	%
	Collector Saturation Voltage	V <sub>CE (sat)</sub>	I <sub>F</sub> = 1 mA, I <sub>c</sub> = 2 mA			1.0	V
	Isolation Resistance	R <sub>I-O</sub>	V <sub>I-O</sub> = 1.0 kV <sub>DC</sub>	10 <sup>11</sup>			Ω
	Isolation Capacitance	C <sub>I-O</sub>	V = 0 V, f = 1.0 MHz		0.6		pF
	Rise Time*1	t <sub>r</sub>	V <sub>CC</sub> = 5 V, I <sub>c</sub> = 10 mA, R <sub>L</sub> = 100 Ω		100		μs
	Fall Time*1	t <sub>f</sub>			100		

Note: \*1. Test Circuit for Switching Time

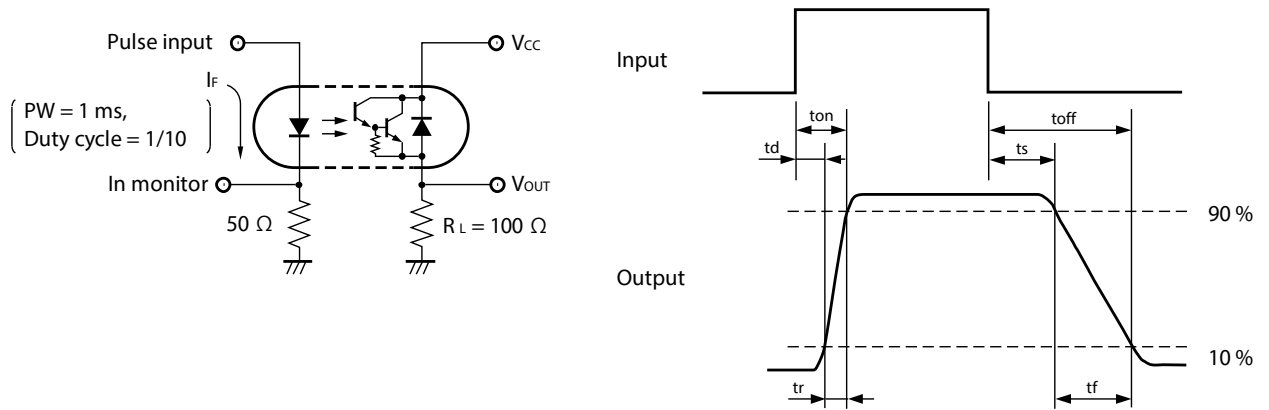

**TYPICAL CHARACTERISTICS (T<sub>A</sub> = 25 °C, unless otherwise specified)**

DIODE POWER DISSIPATION vs. AMBIENT TEMPERATURE

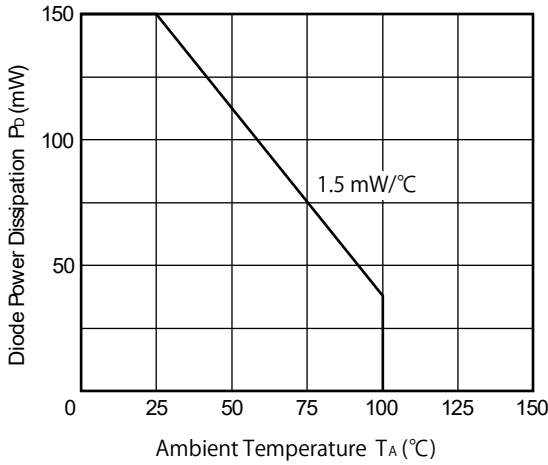

TRANSISTOR POWER DISSIPATION vs. AMBIENT TEMPERATURE

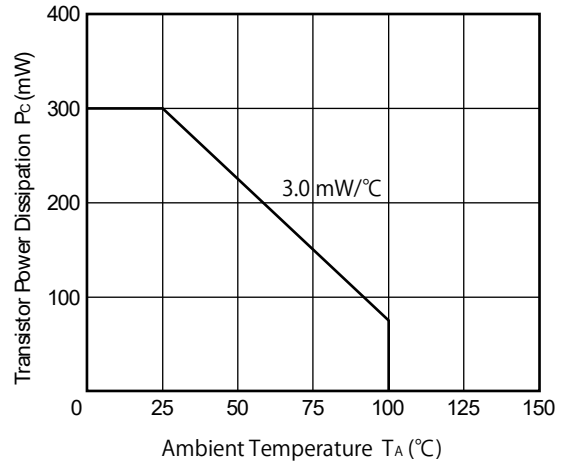

FORWARD CURRENT vs. FORWARD VOLTAGE

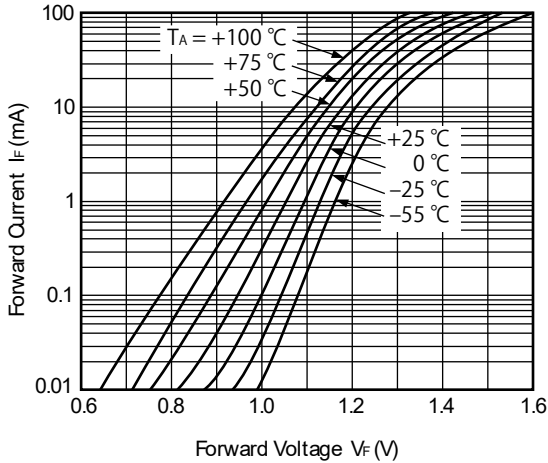

COLLECTOR CURRENT vs. COLLECTOR TO EMITTER VOLTAGE

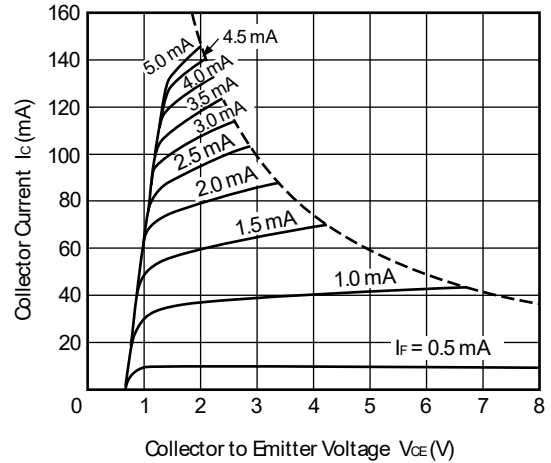

COLLECTOR TO EMITTER DARK CURRENT vs. AMBIENT TEMPERATURE

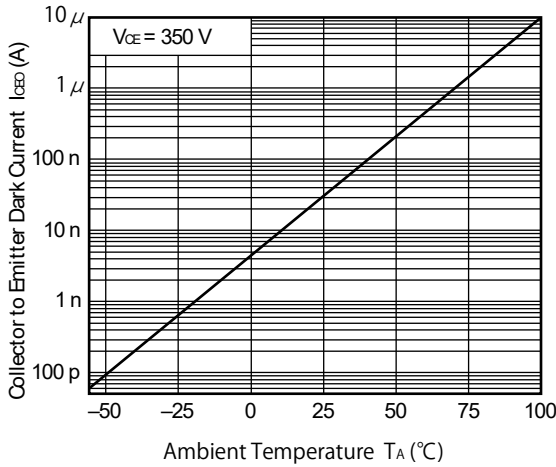

COLLECTOR CURRENT vs. COLLECTOR SATURATION VOLTAGE

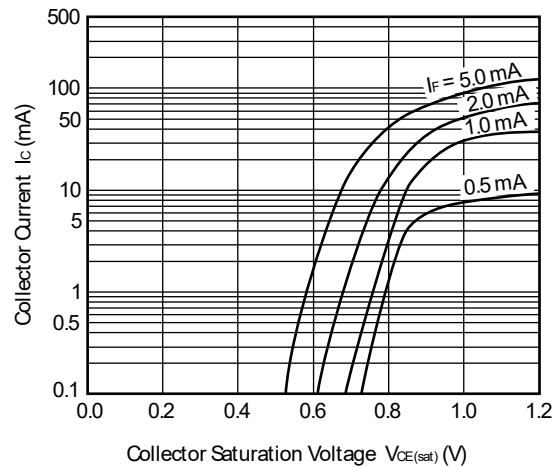

**Remark** The graphs indicate nominal characteristics.

NORMALIZED CURRENT TRANSFER RATIO vs. AMBIENT TEMPERATURE

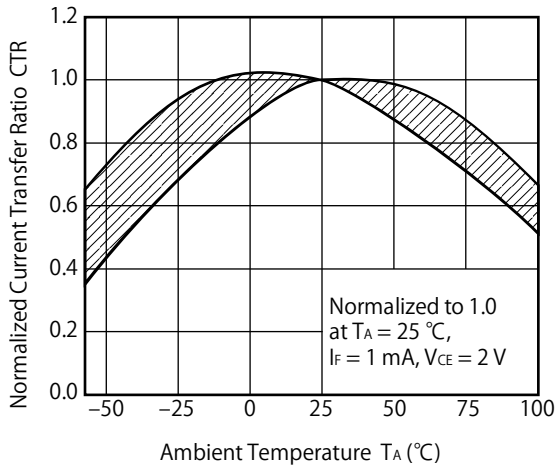

CURRENT TRANSFER RATIO vs. FORWARD CURRENT

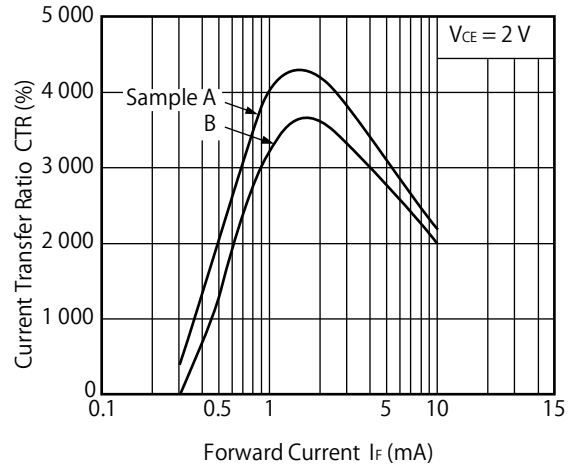

SWITCHING TIME vs. LOAD RESISTANCE

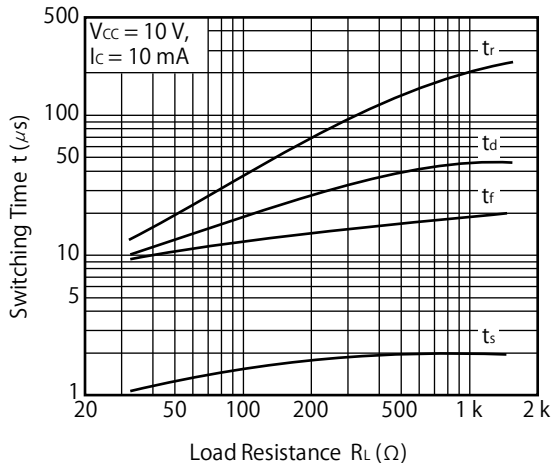

FREQUENCY RESPONSE

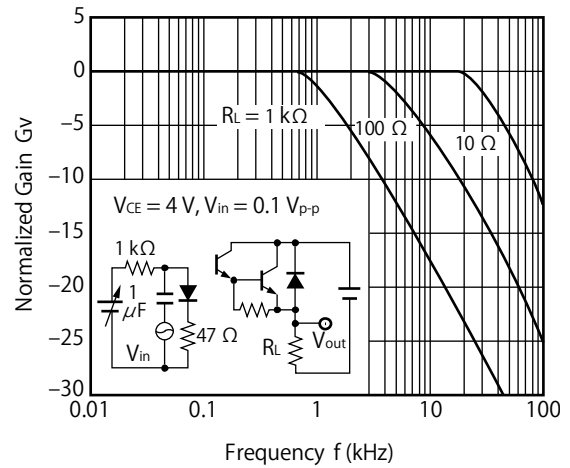

**Remark** The graphs indicate nominal characteristics.

TAPING SPECIFICATIONS (UNIT: mm)

Taping Direction

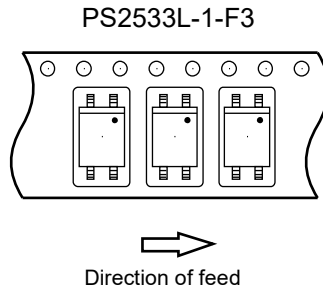

Outline and Dimensions (Tape)



Outline and Dimensions (Reel)



Packing: 2 000 pcs/reel



**RECOMMENDED MOUNT PAD DIMENSIONS (UNIT: mm)**

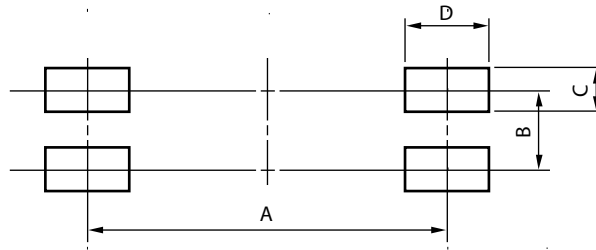
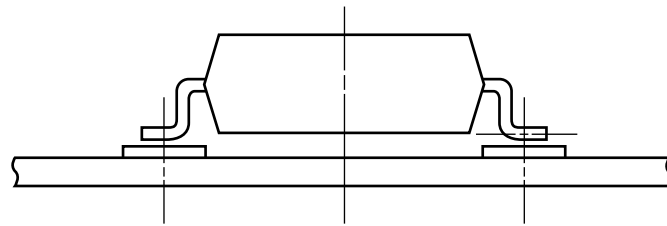

Part Number	Lead Bending	A	B	C	D
PS2533L	Lead Bending Type For Surface Mount	8.2	2.54	1.7	2.2

**Remark** All dimensions in this figure must be evaluated before use.

**NOTES ON HANDLING**

1. Recommended soldering conditions

(1) Infrared reflow soldering

- Peak reflow temperature 260 °C or below (package surface temperature)
- Time of peak reflow temperature 10 seconds or less
- Time of temperature higher than 220°C 60 seconds or less
- Time to preheat temperature from 120 to 180°C 120 ± 30 s
- Number of reflows Three
- Flux Rosin flux containing small amount of chlorine  
(The flux with a maximum chlorine content of 0.2 Wt% is recommended.)

Recommended Temperature Profile of Infrared Reflow

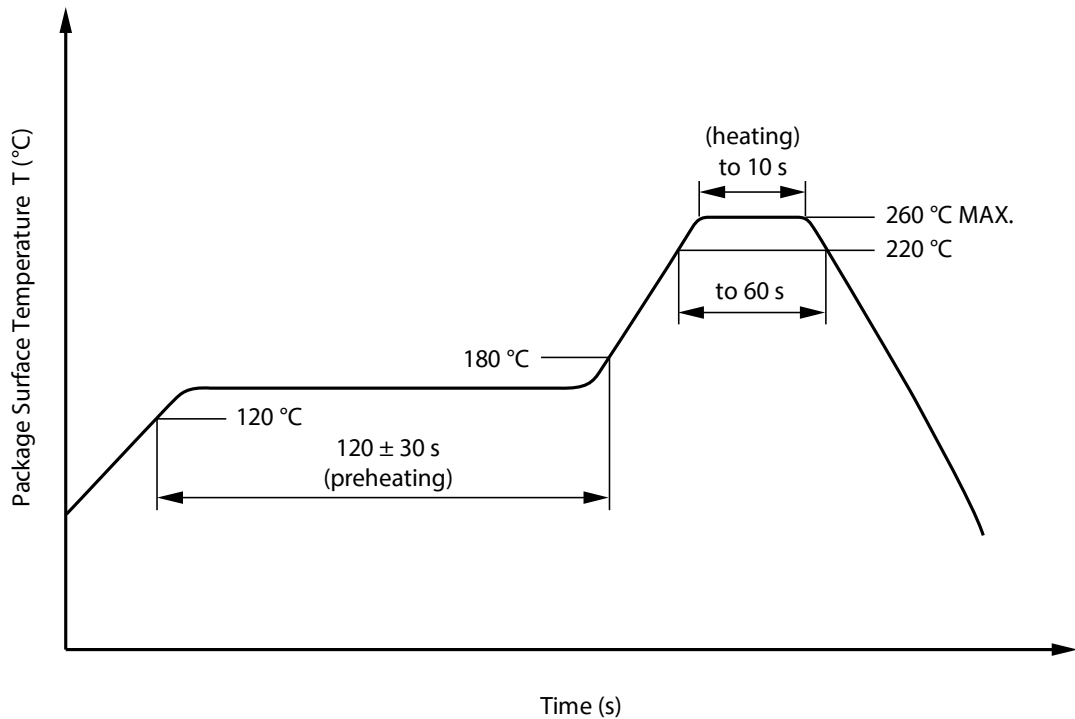

(2) Wave soldering

- Temperature 260 °C or below (molten solder temperature)
- Time 10 seconds or less
- Preheating conditions 120 °C or below (package surface temperature)
- Number of times One (Allowed to be dipped in solder including plastic mold portion.)
- Flux Rosin flux containing small amount of chlorine (The flux with a maximum chlorine content of 0.2 Wt% is recommended.)

(3) Soldering by Soldering Iron

- Peak Temperature (lead part temperature) 350 °C or below
- Time (each pins) 3 seconds or less
- Flux Rosin flux containing small amount of chlorine  
(The flux with a maximum chlorine content of 0.2 Wt% is recommended.)

- (a) Soldering of leads should be made at the point 1.5 to 2.0 mm from the root of the lead
- (b) Please be sure that the temperature of the package would not be heated over 100 °C

(4) Cautions

- Flux Cleaning  
Avoid cleaning with Freon based or halogen-based (chlorinated etc.) solvents.
- Do not use fixing agents or coatings containing halogen-based substances.

2. Cautions regarding noise

Be aware that when voltage is applied suddenly between the photocoupler's input and output or between collector-emitters at startup, the output transistor may enter the on state, even if the voltage is within the absolute maximum ratings.

3. Measurement conditions of current transfer ratios (CTR), which differ according to photocoupler

Check the setting values before use, since the forward current conditions at CTR measurement differ according to product.

When using products other than at the specified forward current, the characteristics curves may differ from the standard curves due to CTR value variations or the like. Therefore, check the characteristics under the actual operating conditions and thoroughly take variations or the like into consideration before use.

## **USAGE CAUTIONS**

1. Protect against static electricity when handling.
2. Avoid storage at a high temperature and high humidity.
3. Avoid cleaning with Freon based or halogen-based (chlorinated etc.) solvents.
4. Do not use fixing agents or coatings containing halogen-based substances.

**SPECIFICATION OF VDE MARKS LICENSE DOCUMENT**

Parameter	Symbol	Rating	Unit
Climatic test class (IEC 60068-1/DIN EN 60068-1)		55/100/21	
Dielectric strength maximum operating isolation voltage Test voltage (partial discharge test, procedure a for type test and random test) $U_{pr} = 1.6 \times U_{IORM}, P_d < 5 \text{ pC}$	$U_{IORM}$ $U_{pr}$	890 1 424	$V_{peak}$ $V_{peak}$
Test voltage (partial discharge test, procedure b for all devices) $U_{pr} = 1.875 \times U_{IORM}, P_d < 5 \text{ pC}$	$U_{pr}$	1 669	$V_{peak}$
Highest permissible overvoltage	$U_{IOTM}$	8 000	$V_{peak}$
Degree of pollution (IEC 60664-1/DIN EN 60664-1 (VDE 0110-1))		2	
Comparative tracking index (IEC 60112/DIN EN 60112 (VDE 0303-11))	CTI	175	
Material group (IEC 60664-1/DIN EN 60664-1 (VDE 0110-1))		III a	
Storage temperature range	$T_{stg}$	-55 to +150	°C
Operating temperature range	$T_A$	-55 to +100	°C
Isolation resistance, minimum value $V_{IO} = 500 \text{ V dc at } T_A = 25^\circ\text{C}$ $V_{IO} = 500 \text{ V dc at } T_A \text{ MAX. at least } 100^\circ\text{C}$	$R_{is \text{ MIN.}}$ $R_{is \text{ MIN.}}$	$10^{12}$ $10^{11}$	$\Omega$ $\Omega$
Safety maximum ratings (maximum permissible in case of fault, see thermal derating curve) Package temperature Current (input current $I_F$ , $P_{si} = 0$ ) Power (output or total power dissipation) Isolation resistance $V_{IO} = 500 \text{ V dc at } T_A = T_{si}$	$T_{si}$ $I_{si}$ $P_{si}$ $R_{is \text{ MIN.}}$	175 400 700 $10^9$	°C mA mW $\Omega$

Dependence of maximum safety ratings with package temperature

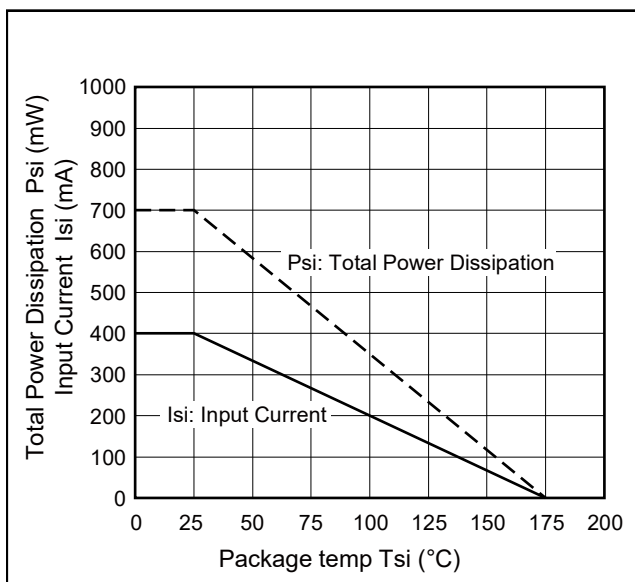

Method a) Destructive Test, Type and Sample Test

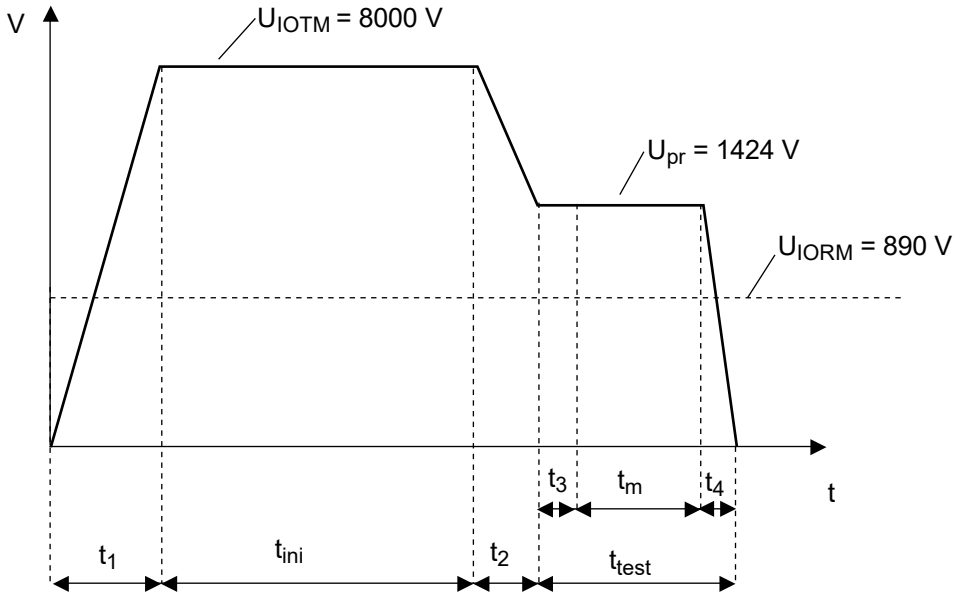

$t_1, t_2 = 1\text{ to }10\text{ sec}$   
 $t_3, t_4 = 1\text{ sec}$   
 $t_m(\text{PARTIAL DISCHARGE}) = 10\text{ sec}$   
 $t_{test} = 12\text{ sec}$   
 $t_{ini} = 60\text{ sec}$

Method b) Non-destructive Test, 100 % Production Test

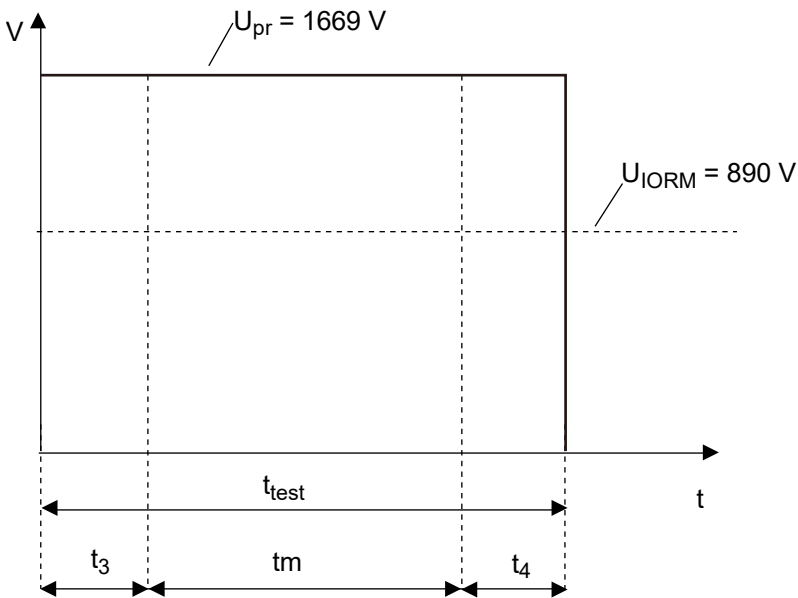

$t_3, t_4 = 0.1\text{ sec}$   
 $t_m(\text{PARTIAL DISCHARGE}) = 1.0\text{ sec}$   
 $t_{test} = 1.2\text{ sec}$

<b>Caution</b>	GaAs Products	<p>This product uses gallium arsenide (GaAs). GaAs vapor and powder are hazardous to human health if inhaled or ingested, so please observe the following points.</p> <ul style="list-style-type: none"><li>• Follow related laws and ordinances when disposing of the product. If there are no applicable laws and/or ordinances, dispose of the product as recommended below.<ol style="list-style-type: none"><li>1. Commission a disposal company able to (with a license to) collect, transport and dispose of materials that contain arsenic and other such industrial waste materials.</li><li>2. Exclude the product from general industrial waste and household garbage, and ensure that the product is controlled (as industrial waste subject to special control) up until final disposal.</li></ol></li><li>• Do not burn, destroy, cut, crush, or chemically dissolve the product.</li><li>• Do not lick the product or in any way allow it to enter the mouth.</li></ul>
----------------	---------------	--

All trademarks and registered trademarks are the property of their respective owners.