

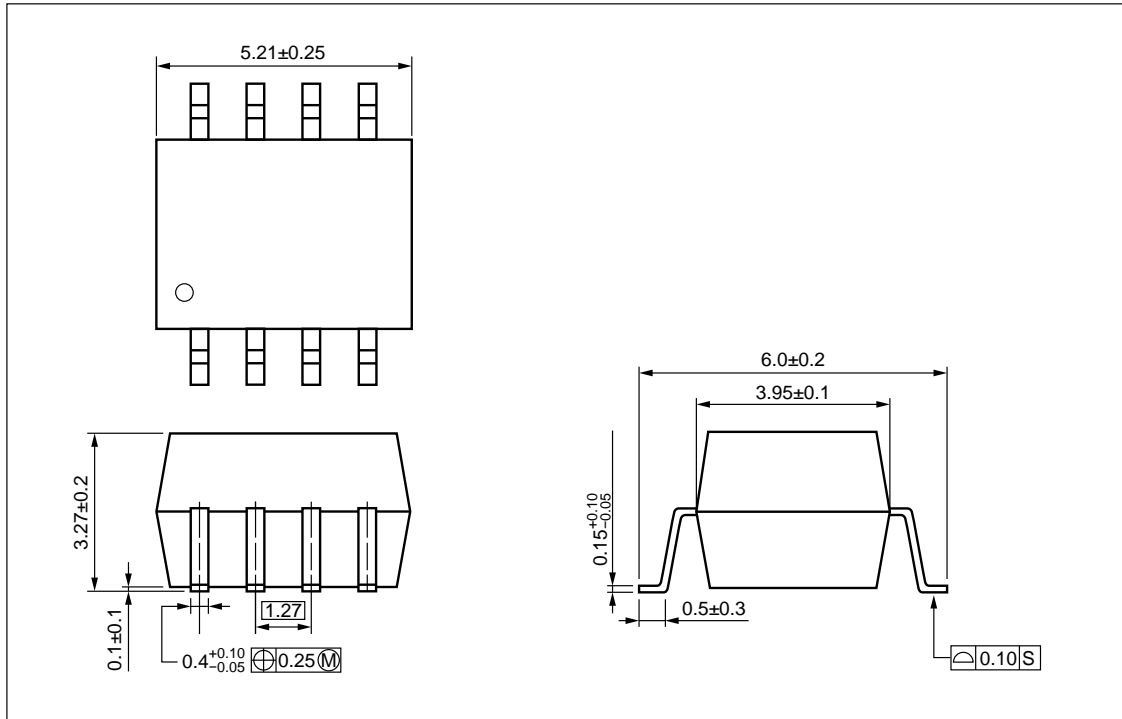

**PACKAGE DIMENSIONS (UNIT: mm)**



Weight: 0.14g (typ.)

**PHOTOCOUPLER CONSTRUCTION**

Parameter	Unit (MIN.)
Air Distance	4 mm
Outer Creepage Distance	4 mm
Isolation Distance	0.2 mm

**MARKING EXAMPLE**

Ni/Pd/Au PLATING

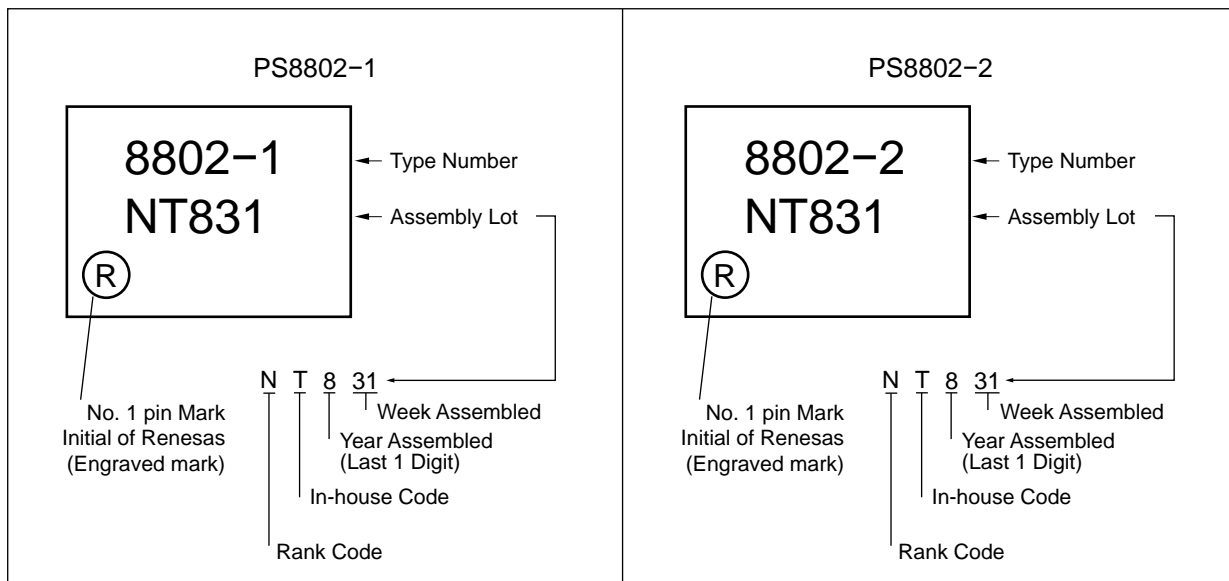

**ORDERING INFORMATION**

Part Number	Order Number	Solder Plating Specification	Packing Style	Safety Standard Approval	Application Part Number*1
PS8802-1	PS8802-1-AX	Pb-Free (Ni/Pd/Au)	20 pcs (Tape 20 pcs cut)	Standard products (UL, CSA approved)	PS8802-1
PS8802-1-F3	PS8802-1-F3-AX		Embossed Tape 1 500 pcs/reel		
PS8802-2	PS8802-2-AX		20 pcs (Tape 20 pcs cut)		PS8802-2
PS8802-2-F3	PS8802-2-F3-AX		Embossed Tape 1 500 pcs/reel		
PS8802-1-V	PS8802-1-V-AX		20 pcs (Tape 20 pcs cut)	UL, CSA, DIN EN 60747-5-5 approved	PS8802-1
PS8802-1-V-F3	PS8802-1-V-F3-AX		Embossed Tape 1 500 pcs/reel		
PS8802-2-V	PS8802-2-V-AX		20 pcs (Tape 20 pcs cut)		PS8802-2
PS8802-2-V-F3	PS8802-2-V-F3-AX		Embossed Tape 1 500 pcs/reel		

Notes\*: 1. For the application of the Safety Standard, following part number should be used.

**ABSOLUTE MAXIMUM RATINGS (T<sub>A</sub> = 25 °C, unless otherwise specified)**

Parameter		Symbol	Ratings	Unit
Diode	Forward Current	I <sub>F</sub>	25	mA/ch
	Reverse Voltage	V <sub>R</sub>	5.0	V/ch
	Power Dissipation*1	P <sub>D</sub>	45	mW/ch
Detector	Supply Voltage	V <sub>CC</sub>	35	V
	Output Voltage	V <sub>O</sub>	35	V/ch
	Output Current	I <sub>O</sub>	8.0	mA/ch
	Power Dissipation *2	P <sub>C</sub>	100	mW/ch
Isolation Voltage *3		BV	2 500	Vr.m.s.
Operating Ambient Temperature		T <sub>A</sub>	- 55 to + 100	°C
Storage Temperature		T <sub>stg</sub>	- 55 to + 125	°C

- Notes\*: 1. Reduced to 0.45 mW/°C at T<sub>A</sub> = 25 °C or more.  
 2. Reduced to 1.00 mW/°C at T<sub>A</sub> = 25 °C or more.  
 3. AC voltage for 1 minute at T<sub>A</sub> = 25 °C, RH = 60 % between input and output.  
 Pins 1-4 shorted together, 5-8 shorted together.

ELECTRICAL CHARACTERISTICS (T<sub>A</sub> = 25 °C)

Parameter		Symbol	Conditions	MIN.	TYP.	MAX.	Unit
Diode	Forward Voltage	V <sub>F</sub>	I <sub>F</sub> = 16 mA		1.7	2.2	V
	Reverse Current	I <sub>R</sub>	V <sub>R</sub> = 3 V			10	μA
	Forward Voltage Temperature Coefficient	ΔV <sub>F</sub> /ΔT <sub>A</sub>	I <sub>F</sub> = 16 mA		-2.1		mV/°C
	Terminal Capacitance	C <sub>T</sub>	V = 0 V, f = 1 MHz		30		pF
Detector	High Level Output Current	I <sub>OH</sub> (1)	I <sub>F</sub> = 0 mA, V <sub>CC</sub> = V <sub>O</sub> = 5.5 V		10	500	nA
	High Level Output Current	I <sub>OH</sub> (2)	I <sub>F</sub> = 0 mA, V <sub>CC</sub> = V <sub>O</sub> = 30 V			100	μA
	Low Level Output Voltage	V <sub>OL</sub>	I <sub>F</sub> = 16 mA, V <sub>CC</sub> = 4.5 V, I <sub>OL</sub> = 1.2 mA		0.1	0.4	V
	High Level Supply Current (PS8802-1)	I <sub>CC</sub> H	I <sub>F</sub> = 0 mA, V <sub>O</sub> = open, V <sub>CC</sub> = 30 V		0.1	2	μA
	High Level Supply Current (PS8802-2)				0.2	4	
	Low Level Supply Current (PS8802-1)	I <sub>CC</sub> L	I <sub>F</sub> = 16 mA, V <sub>O</sub> = open, V <sub>CC</sub> = 30 V		100		
	Low Level Supply Current (PS8802-2)				200		
Coupled	Current Transfer Ratio	CTR	I <sub>F</sub> = 16 mA, V <sub>CC</sub> = 4.5 V, V <sub>O</sub> = 0.4 V	15	25	45	%
	Input-Output Isolation Resistance	R <sub>I-O</sub>	V <sub>I-O</sub> = 1 kV <sub>DC</sub> , RH = 40 to 60 %	10 <sup>11</sup>			Ω
	Insulation Resistance (Input-Input), (PS8802-2)	R <sub>I-I</sub>	V <sub>I-I</sub> = 1 kV <sub>DC</sub> , RH = 40 to 60 %	10 <sup>10</sup>			
	Input-Output Isolation Capacitance	C <sub>I-O</sub>	V = 0 V, f = 1 MHz		0.6		pF
	Insulation Capacitance (Input-Input), (PS8802-2)	C <sub>I-I</sub>			0.3		
	Propagation Delay Time (H → L) <sup>*1</sup>	t <sub>PHL</sub>	I <sub>F</sub> = 16 mA, V <sub>CC</sub> = 5 V, R <sub>L</sub> = 2.2 kΩ, C <sub>L</sub> = 15 pF		0.3	0.8	μs
	Propagation Delay Time (L → H) <sup>*1</sup>	t <sub>PLH</sub>			0.6	1.2	
	Common Mode Transient Immunity at High Level Output <sup>*2</sup>	CM <sub>H</sub>	I <sub>F</sub> = 0 mA, V <sub>CC</sub> = 5 V, R <sub>L</sub> = 4.1 kΩ,, V <sub>CM</sub> = 1.5 kV	15			kV/μs
	Common Mode Transient Immunity at Low Level Output <sup>*2</sup>	CM <sub>L</sub>	I <sub>F</sub> = 16 mA, V <sub>CC</sub> = 5 V, R <sub>L</sub> = 4.1 kΩ,, V <sub>CM</sub> = 1.5 kV	-15			

Notes\*: 1. Test circuit for propagation delay time

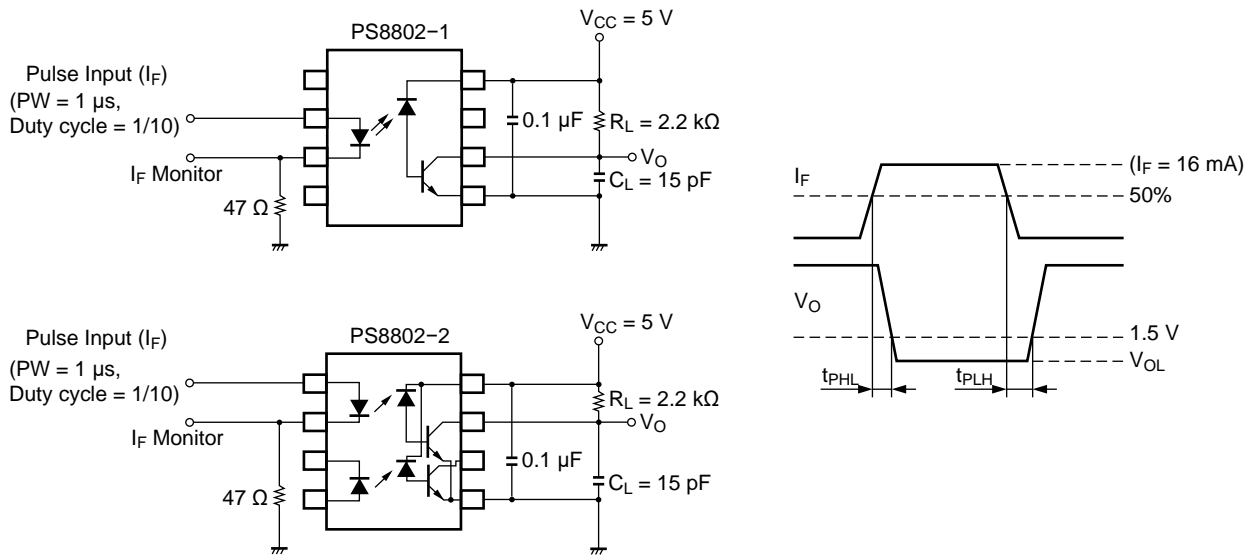

Remark: C<sub>L</sub> includes probe and stray wiring capacitance.

2. Test circuit for common mode transient immunity

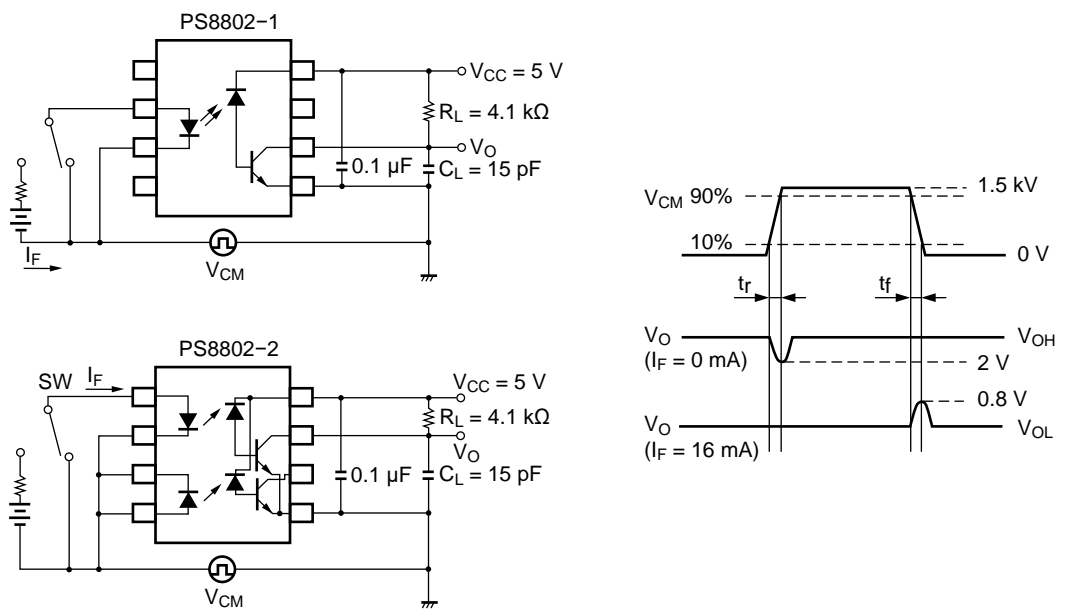

Remark: C<sub>L</sub> includes probe and stray wiring capacitance.

## USAGE CAUTIONS

1. This product is weak for static electricity by designed with high-speed integrated circuit so protect against static electricity when handling.
2. By-pass capacitor of 0.1 μF is used between V<sub>CC</sub> and GND near device. Also, ensure that the distance between the leads of the photocoupler and capacitor is no more than 10 mm.
3. Avoid storage at a high temperature and high humidity.
4. Avoid cleaning with Freon based or halogen-based (chlorinated etc.) solvents.
5. Do not use fixing agents or coatings containing halogen-based substances.

TYPICAL CHARACTERISTICS ( $T_A = 25\text{ }^\circ\text{C}$  unless otherwise specified)

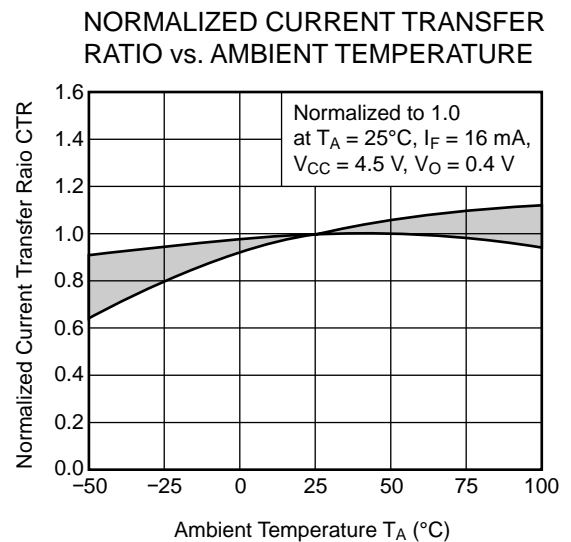
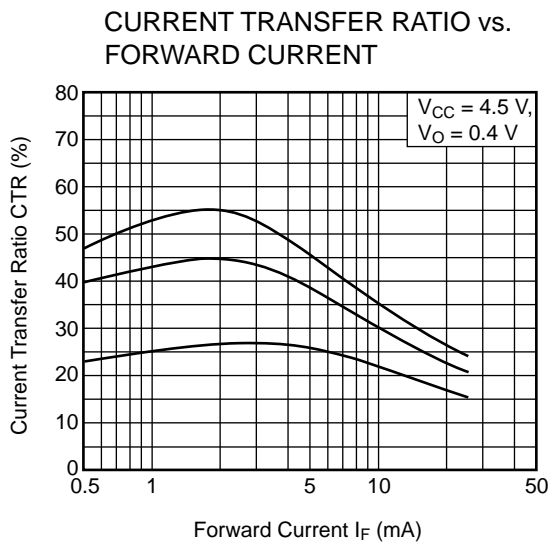
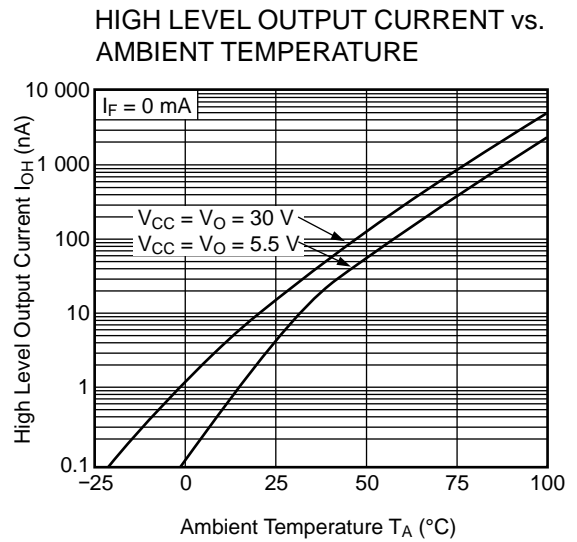
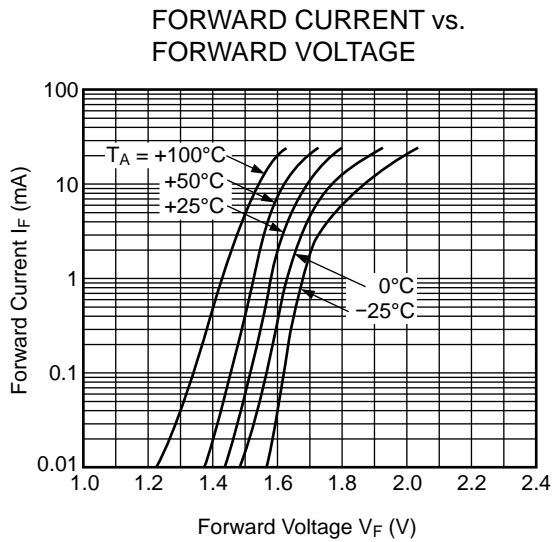
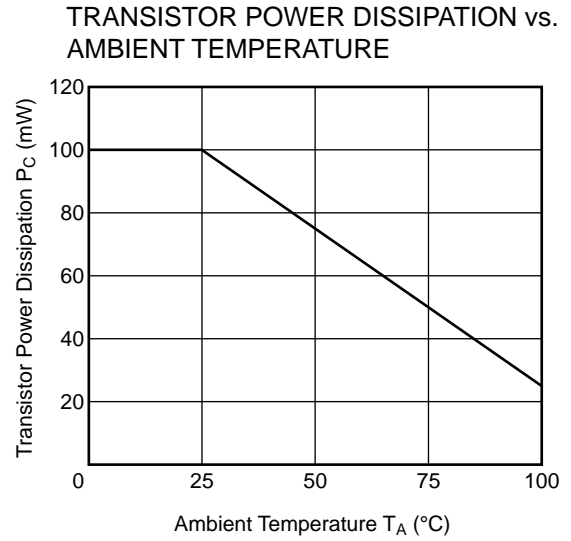
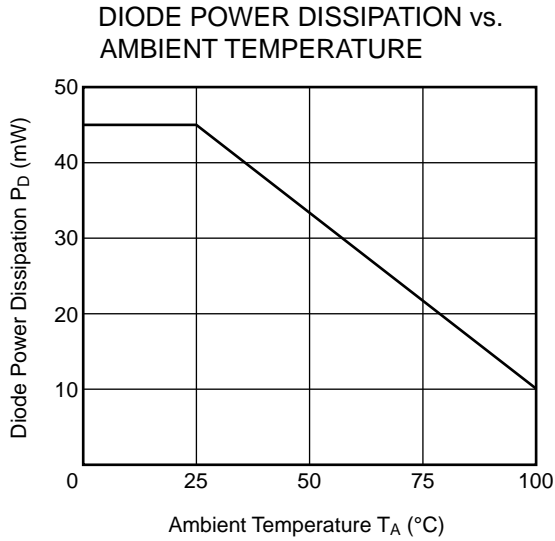

Remark The graphs indicate nominal characteristics.

OUTPUT CURRENT vs. OUTPUT VOLTAGE

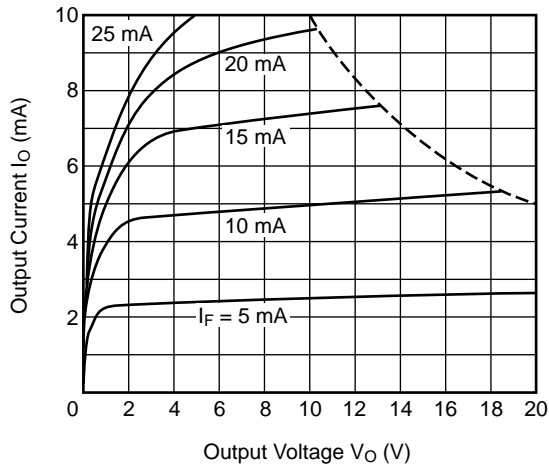

OUTPUT VOLTAGE vs. FORWARD CURRENT

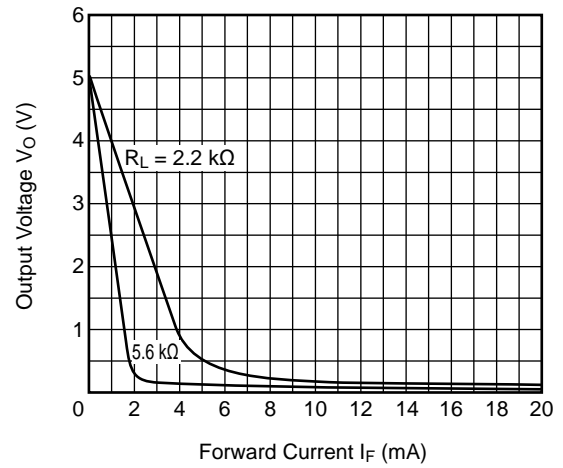

PROPAGATION DELAY TIME vs. FORWARD CURRENT

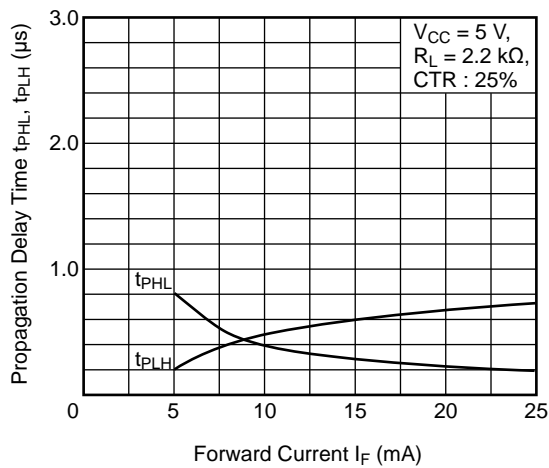

PROPAGATION DELAY TIME vs. LOAD RESISTANCE

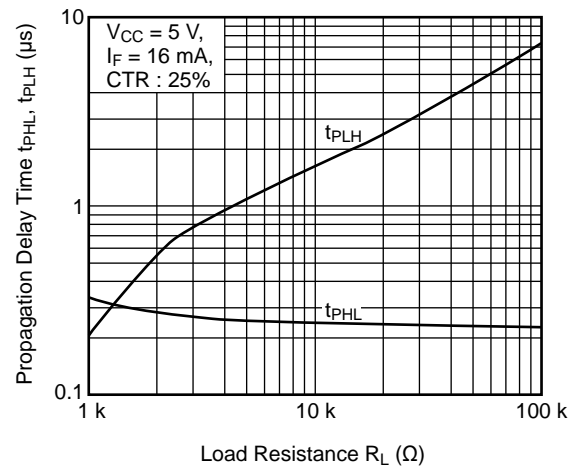

NORMALIZED PROPAGATION DELAY TIME vs. AMBIENT TEMPERATURE

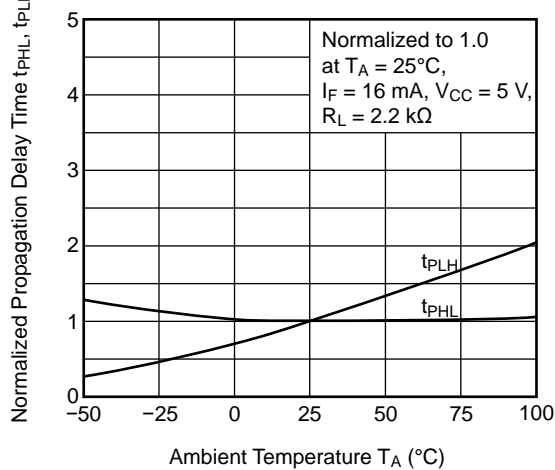

Remark The graphs indicate nominal characteristics.

TAPING SPECIFICATIONS (UNIT: mm)

Taping Direction

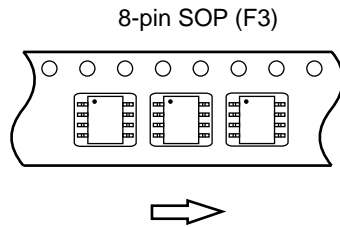

Outline and Dimensions (Tape)

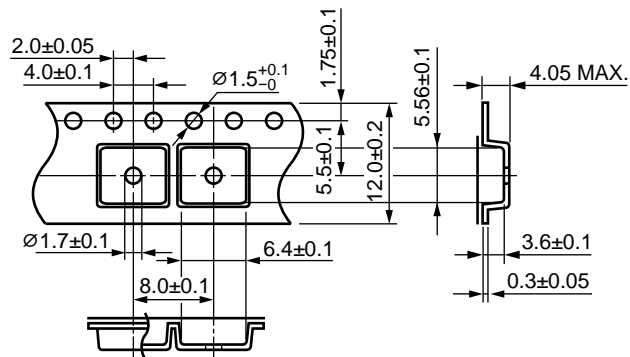

Outline and Dimensions (Reel)

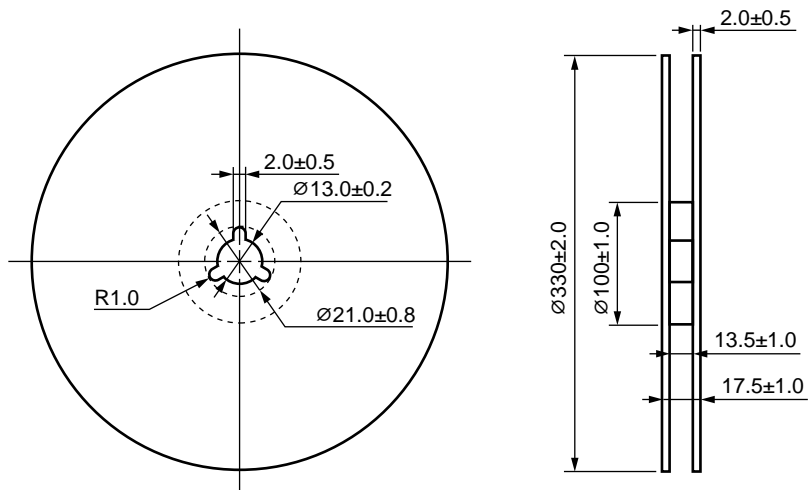

Packing: 1 500 pcs/reel



RECOMMENDED MOUNT PAD DIMENSIONS (UNIT: mm)

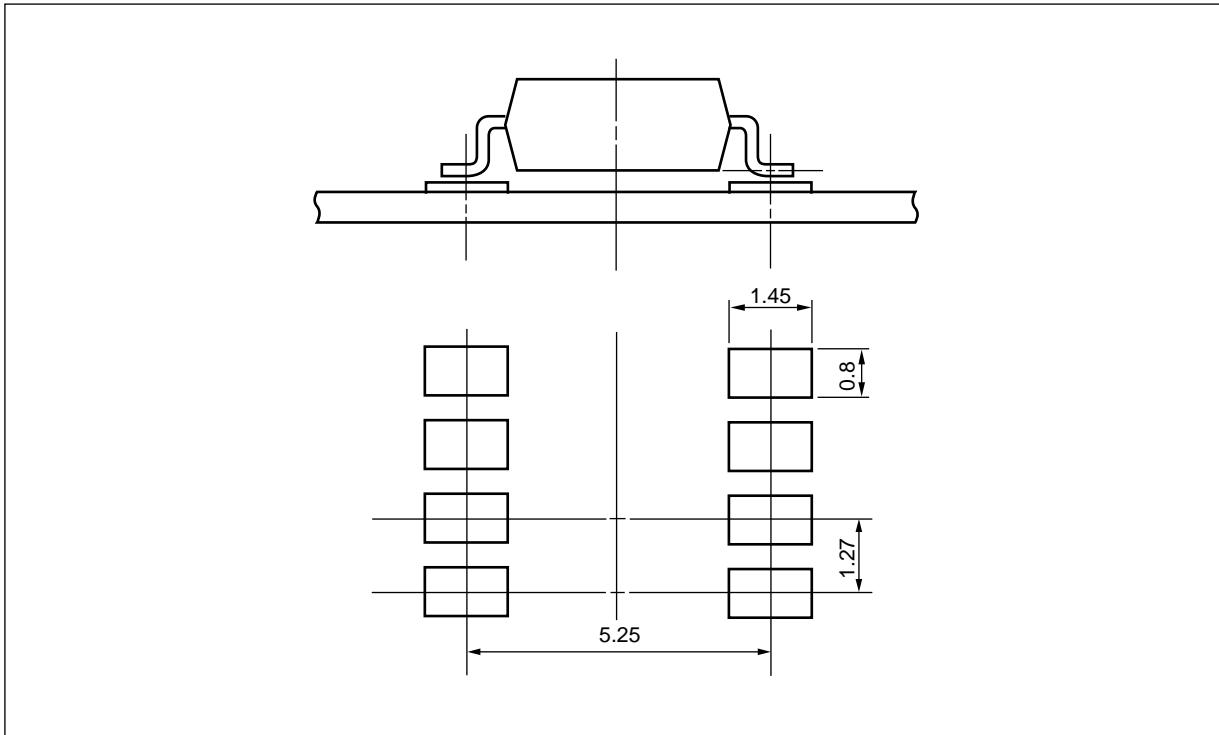

Remark All dimensions in this figure must be evaluated before use.

**NOTES ON HANDLING**

1. Recommended soldering conditions

(1) Infrared reflow soldering

- Peak reflow temperature 260 °C or below (package surface temperature)
- Time of peak reflow temperature 10 seconds or less
- Time of temperature higher than 220 °C 60 seconds or less
- Time to preheat temperature from 120 to 180 °C 120 ± 30 s
- Number of reflows Three
- Flux Rosin flux containing small amount of chlorine (The flux with a maximum chlorine content of 0.2 Wt% is recommended.)

Recommended Temperature Profile of Infrared Reflow

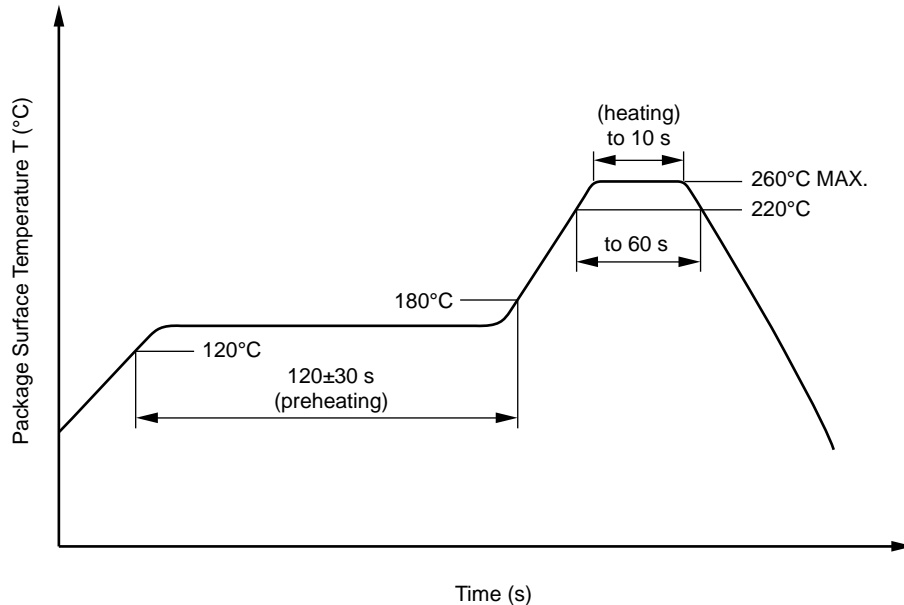

(2) Wave soldering

- Temperature 260 °C or below (molten solder temperature)
- Time 10 seconds or less
- Preheating conditions 120 °C or below (package surface temperature)
- Number of times One (Allowed to be dipped in solder including plastic mold portion.)
- Flux Rosin flux containing small amount of chlorine (The flux with a maximum chlorine content of 0.2 Wt% is recommended.)

(3) Soldering by Soldering Iron

- Peak Temperature (lead part temperature) 350 °C or below
- Time (each pins) 3 seconds or less
- Flux Rosin flux containing small amount of chlorine (The flux with a maximum chlorine content of 0.2 Wt% is recommended.)

(a) Soldering of leads should be made at the point 1.5 to 2.0 mm from the root of the lead

(b) Please be sure that the temperature of the package would not be heated over 100 °C

(4) Cautions

- Flux Cleaning  
Avoid cleaning with Freon based or halogen-based (chlorinated etc.) solvents.
- Do not use fixing agents or coatings containing halogen-based substances.

2. Cautions regarding noise

Be aware that when voltage is applied suddenly between the photocoupler's input and output or between collector-emitters at startup, the output transistor may enter the on state, even if the voltage is within the absolute maximum ratings.

**SPECIFICATION OF VDE MARKS LICENSE DOCUMENT**

Parameter	Symbol	Rating	Unit
Climatic test class (IEC 60068-1/DIN EN 60068-1)		55/100/21	
Dielectric strength maximum operating isolation voltage Test voltage (partial discharge test, procedure a for type test and random test) $U_{pr} = 1.6 \times U_{IORM}, P_d < 5 \text{ pC}$	$U_{IORM}$ $U_{pr}$	566 905	$V_{peak}$ $V_{peak}$
Test voltage (partial discharge test, procedure b for all devices) $U_{pr} = 1.875 \times U_{IORM}, P_d < 5 \text{ pC}$	$U_{pr}$	1 061	$V_{peak}$
Highest permissible overvoltage	$U_{IOTM}$	4 000	$V_{peak}$
Degree of pollution (IEC 60664-1/DIN EN 60664-1 (VDE 0110-1))		2	
Comparative tracking index (IEC 60112/DIN EN 60112 (VDE 0303-11))	CTI	175	
Material group (IEC 60664-1/DIN EN 60664-1 (VDE 0110-1))		III a	
Storage temperature range	$T_{stg}$	- 55 to +125	°C
Operating temperature range	$T_A$	- 55 to +100	°C
Isolation resistance, minimum value $V_{IO} = 500 \text{ V dc at } T_A = 25 \text{ °C}$ $V_{IO} = 500 \text{ V dc at } T_A \text{ MAX. at least } 100 \text{ °C}$	Ris MIN. Ris MIN.	$10^{12}$ $10^{11}$	$\Omega$ $\Omega$
Safety maximum ratings (maximum permissible in case of fault, see thermal derating curve) Package temperature Current (input current $I_F$ , $P_{si} = 0$ ) Power (output or total power dissipation) Isolation resistance $V_{IO} = 500 \text{ V dc at } T_A = T_{si}$	$T_{si}$ $I_{si}$ $P_{si}$ Ris MIN.	150 150 600 $10^9$	°C mA mW $\Omega$

**Dependence of maximum safety ratings with package temperature**

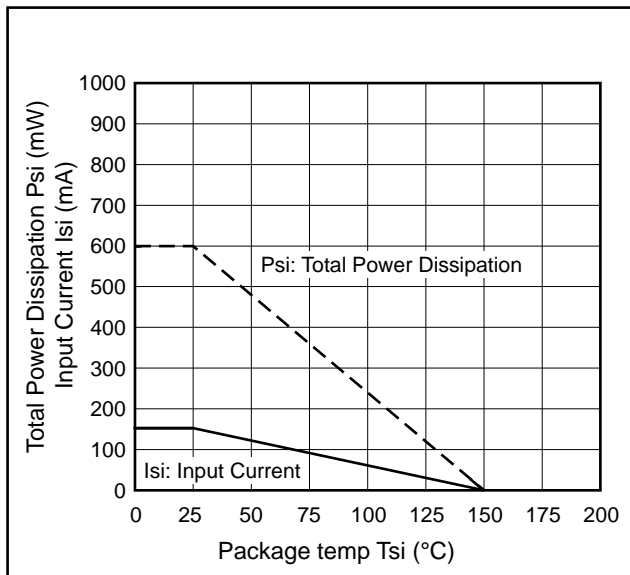

**Method a) Destructive Test, Type and Sample Test**

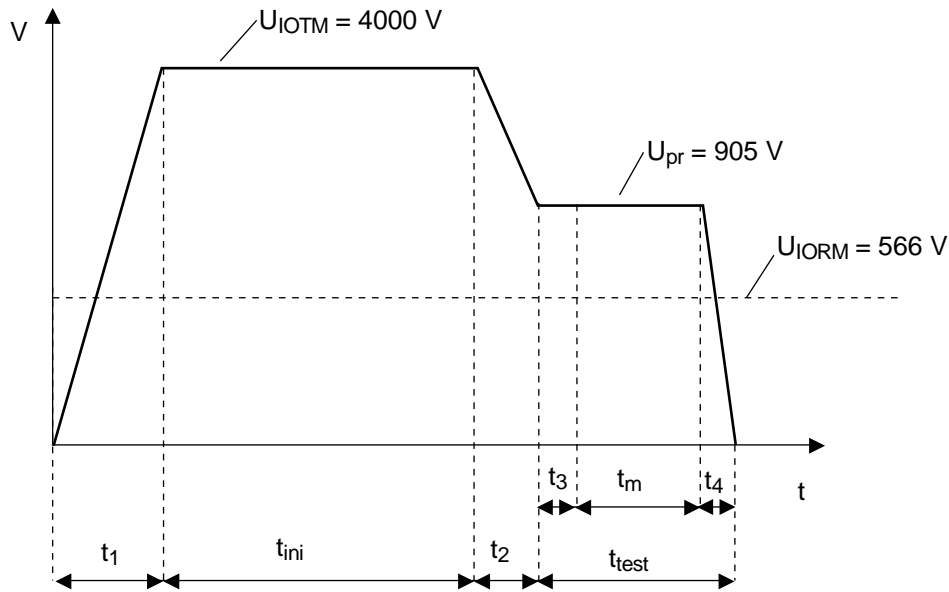

$t_1, t_2 = 1\text{ to }10\text{ sec}$   
 $t_3, t_4 = 1\text{ sec}$   
 $t_m(\text{PARTIAL DISCHARGE}) = 10\text{ sec}$   
 $t_{test} = 12\text{ sec}$   
 $t_{ini} = 60\text{ sec}$

**Method b) Non-destructive Test, 100% Production Test**

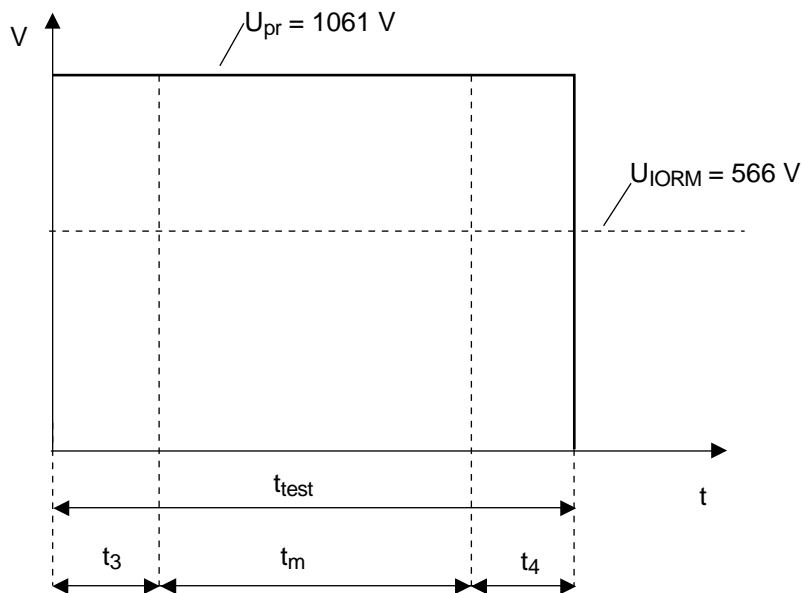

$t_3, t_4 = 0.1\text{ sec}$   
 $t_m(\text{PARTIAL DISCHARGE}) = 1.0\text{ sec}$   
 $t_{test} = 1.2\text{ sec}$

<b>Caution</b>	GaAs Products	<p>This product uses gallium arsenide (GaAs). GaAs vapor and powder are hazardous to human health if inhaled or ingested, so please observe the following points.</p> <ul style="list-style-type: none"><li>• Follow related laws and ordinances when disposing of the product. If there are no applicable laws and/or ordinances, dispose of the product as recommended below.<ol style="list-style-type: none"><li>1. Commission a disposal company able to (with a license to) collect, transport and dispose of materials that contain arsenic and other such industrial waste materials.</li><li>2. Exclude the product from general industrial waste and household garbage, and ensure that the product is controlled (as industrial waste subject to special control) up until final disposal.</li></ol></li><li>• Do not burn, destroy, cut, crush, or chemically dissolve the product.</li><li>• Do not lick the product or in any way allow it to enter the mouth.</li></ul>
----------------	---------------	--

All trademarks and registered trademarks are the property of their respective owners.