

Series: V-Thinity

Description: In Building Public Safety
Antenna 450-490 MHz

PART NUMBER: PSIBUHF

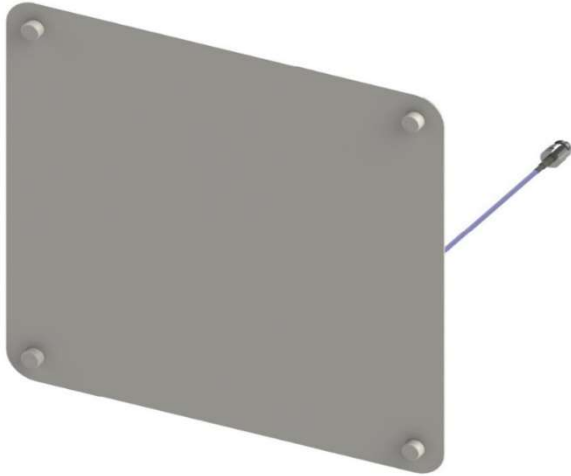

Installed Antenna

Features:

- 450-490 MHz UHF operation
- Aesthetically pleasing:
 - 1.5mm (0.060 inch) thickness to ceiling
- VSWR < 2:1
- Optimized To Low-Frequency In-Building Environments
- Size 15.75 x 15.75 inch (400 x 400 mm)

Applications:

- IN-building repeater systems
- Police, Fire, Government
- Low profile ceiling mounting
- Enhanced for In-Building:
 - Multi-floor coverage
 - Voids the nulls of traditional dipoles

All dimensions are in mm / inches

Issue: 1713

In the effort to improve our products, we reserve the right to make changes judged to be necessary.

CONFIDENTIAL AND PROPRIETARY INFORMATION

This document contains confidential and proprietary information of Pulse Electronics, Inc. (Pulse) and is protected by copyright, trade secret and other state and federal laws. Its receipt or possession does not convey any rights to reproduce, disclose its contents, or to manufacture, use or sell anything it may describe. Reproduction, disclosure or use without specific written authorization of Pulse is strictly forbidden.

For more information:

Pulse Worldwide Headquarters
15255 Innovation Drive #100
San Diego, CA 92128
USA
Tel: 1-858-674-8100

Pulse/Larsen Antennas
18110 SE 34th St Bldg 2 Suite 250
Vancouver, WA 98683
USA
Tel: 1-360-944-7551

Europe Headquarters
Pulse GmbH & Do, KG
Zeppelinstrasse 15
Herrenberg, Germany
Tel: 49 7032 7806 0

Pulse (Suzhou) Wireless Products Co, Inc.
99 Huo Ju Road(#29 Bldg,4th Phase
Suzhou New District
Jiangsu Province, Suzhou 215009 PR China
Tel: 86 512 6807 9998



Description: In Building Public Safety
Antenna 450-490 MHz

Series: V-Thinity

PART NUMBER: PSIBUHF

ELECTRICAL SPECIFICATIONS

Frequency	450-490MHz
Nominal Impedance	50 Ω
VSWR *	2:1
Peak Gain *	4.5 dBi
Total Efficiency *	70 %
Power Withstand	6 watts
* See test setup definition	

MECHANICAL SPECIFICATIONS

Antenna Color / Material	White
Weight	700g (TBC)
Connector Type	N Female
Cable Type	RG402 \varnothing 4mm / 0.16"
Cable length	500mm / 19.7"
Cable retention: Pull off	30 N
Fixing system	4pcs M6 hex slot bolt & nut

ENVIRONMENTAL SPECIFICATIONS

Storage temperature	MIL STD 801G: 24h at 85C and 24h at -40C
Temperature shock	MIL STD 810G: Method 503.5, -40 for 1 hr to +85C for 1 hr @ 15 deg.C/min rate of change; 3 cycles
Humidity	MIL STD 810G: 24h at 60C and 95%RH
Vibration	MIL STD 810G: 514.6 C-II

Issue: 1713

In the effort to improve our products, we reserve the right to make changes judged to be necessary.

CONFIDENTIAL AND PROPRIETARY INFORMATION

This document contains confidential and proprietary information of Pulse Electronics, Inc. (Pulse) and is protected by copyright, trade secret and other state and federal laws. Its receipt or possession does not convey any rights to reproduce, disclose its contents, or to manufacture, use or sell anything it may describe. Reproduction, disclosure or use without specific written authorization of Pulse is strictly forbidden.

Description: In Building Public Safety
Antenna 450-490 MHz

Series: V-Thinity

PART NUMBER: PSIBUHF

MECHANICAL DRAWING

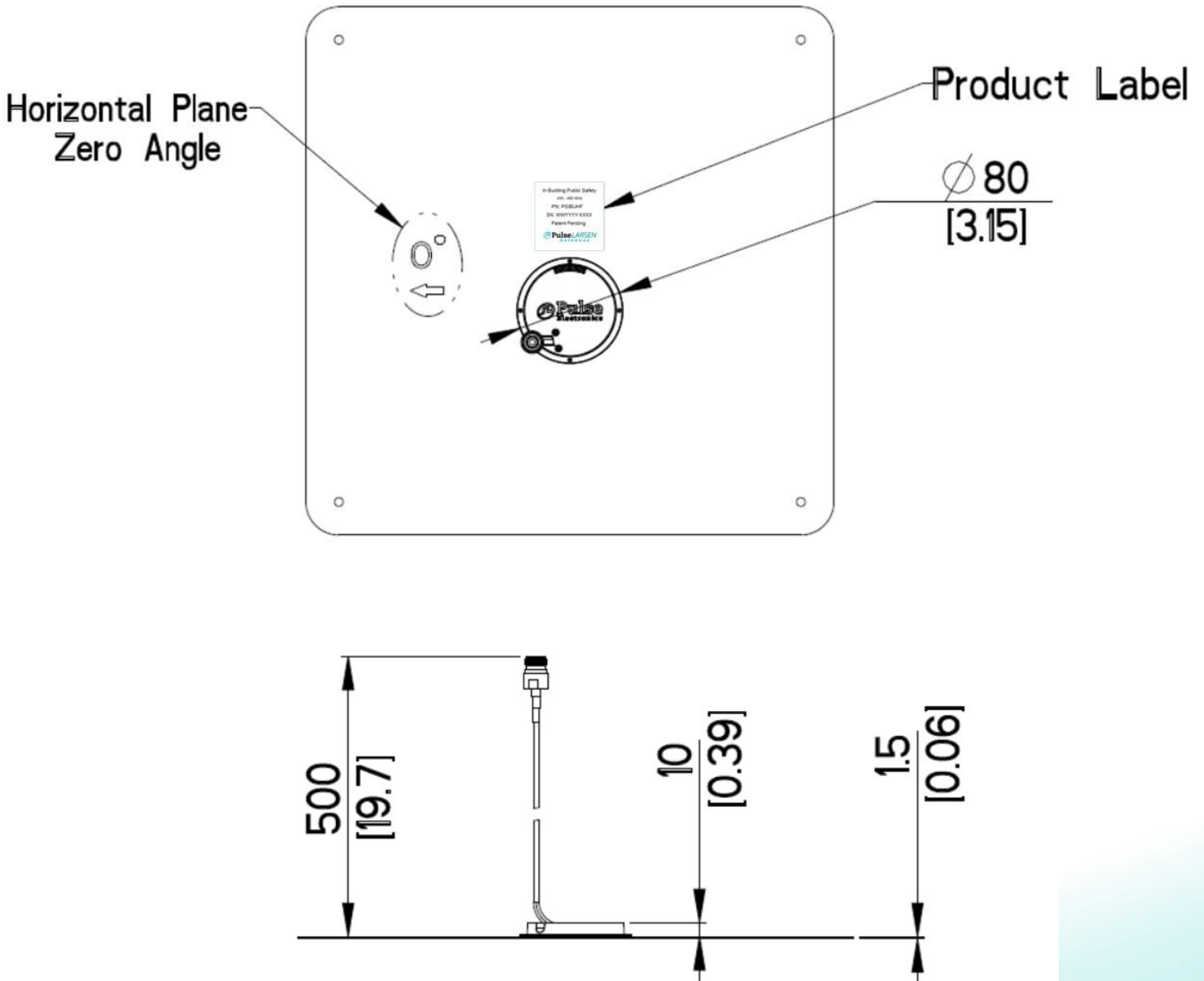

Issue: 1713

In the effort to improve our products, we reserve the right to make changes judged to be necessary.

CONFIDENTIAL AND PROPRIETARY INFORMATION

This document contains confidential and proprietary information of Pulse Electronics, Inc. (Pulse) and is protected by copyright, trade secret and other state and federal laws. Its receipt or possession does not convey any rights to reproduce, disclose its contents, or to manufacture, use or sell anything it may describe. Reproduction, disclosure or use without specific written authorization of Pulse is strictly forbidden.

MECHANICAL DRAWING

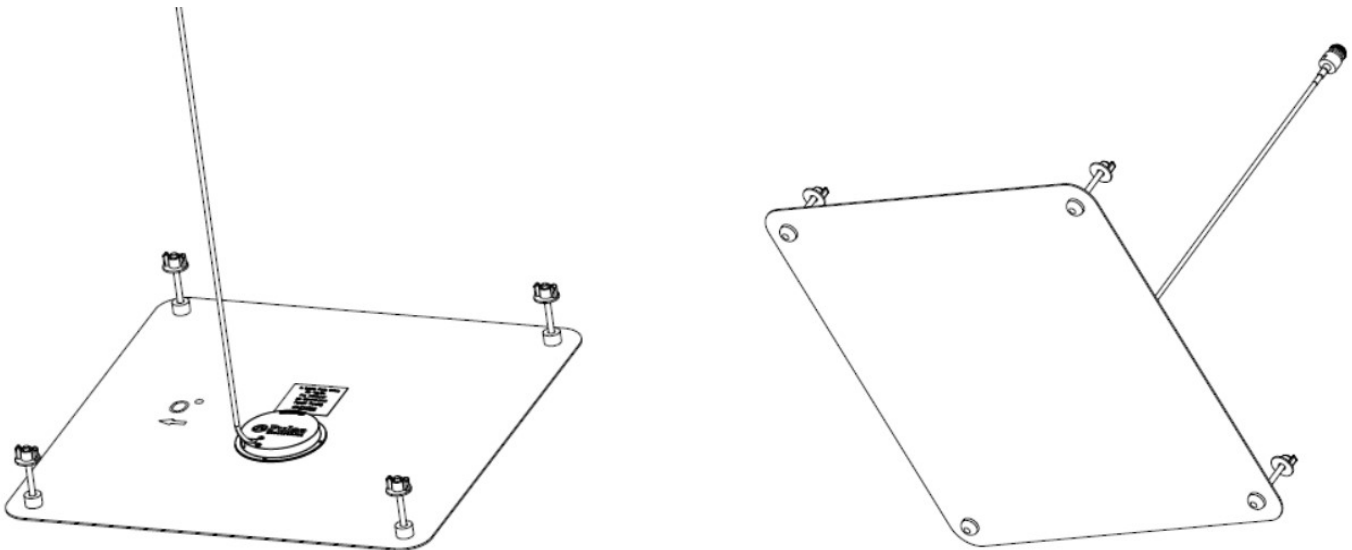
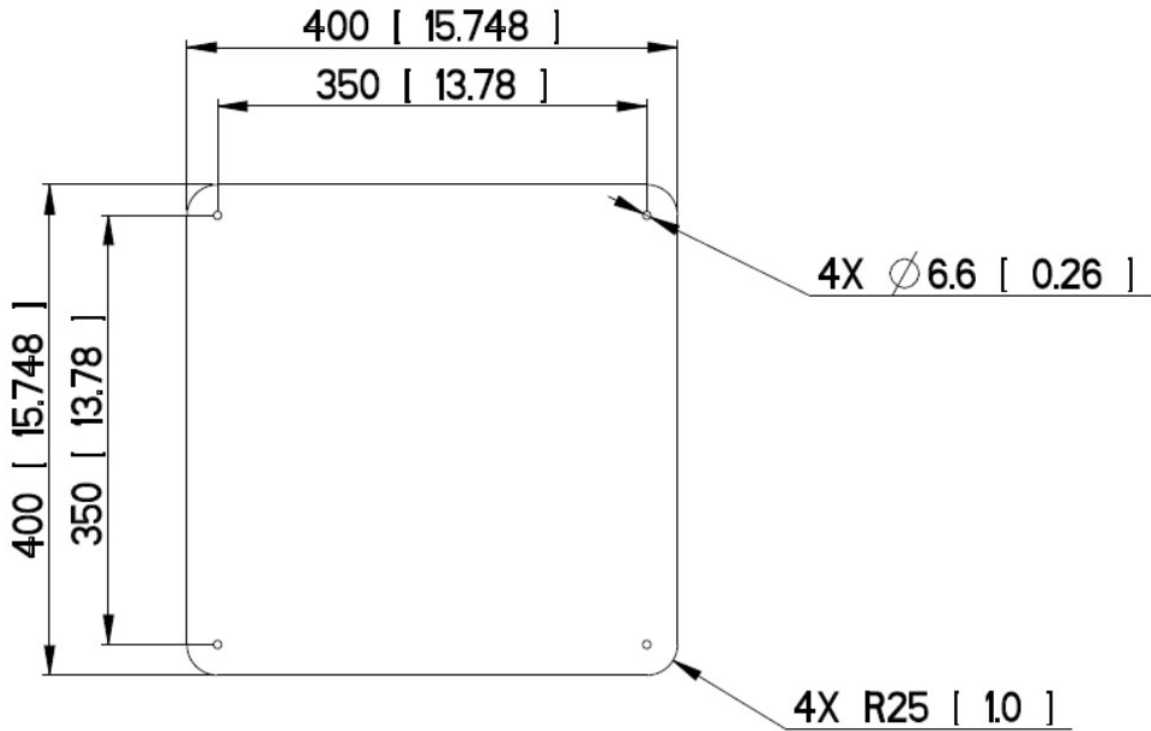

Issue: 1713

In the effort to improve our products, we reserve the right to make changes judged to be necessary.

CONFIDENTIAL AND PROPRIETARY INFORMATION

This document contains confidential and proprietary information of Pulse Electronics, Inc. (Pulse) and is protected by copyright, trade secret and other state and federal laws. Its receipt or possession does not convey any rights to reproduce, disclose its contents, or to manufacture, use or sell anything it may describe. Reproduction, disclosure or use without specific written authorization of Pulse is strictly forbidden.

TEST SETUP

Test setup with 2x2ft ceiling tile and metal rails

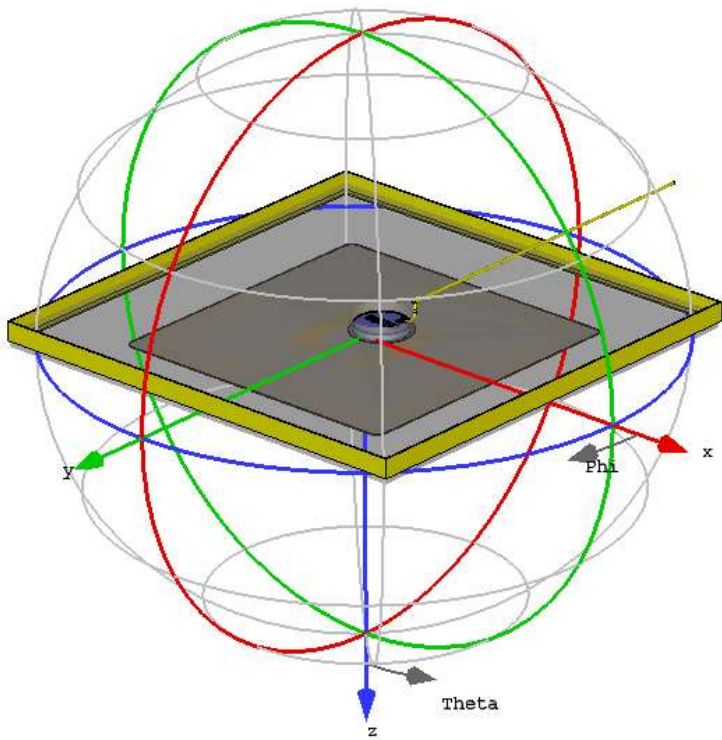

Test setup with 13mm drywall sheet

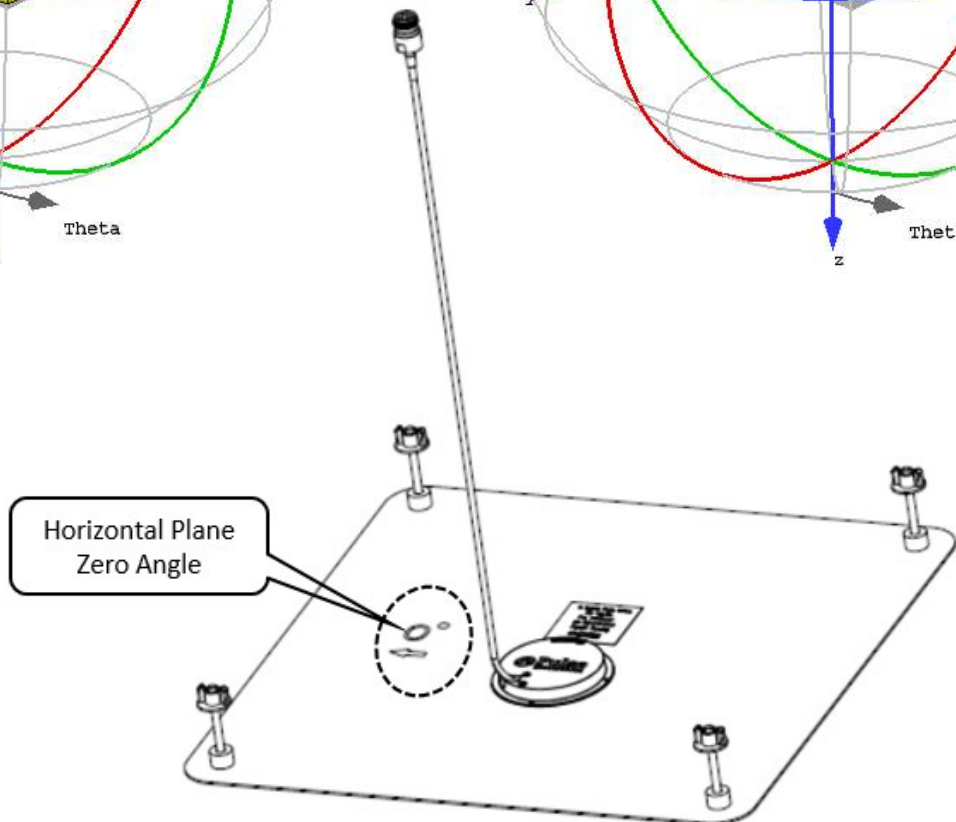
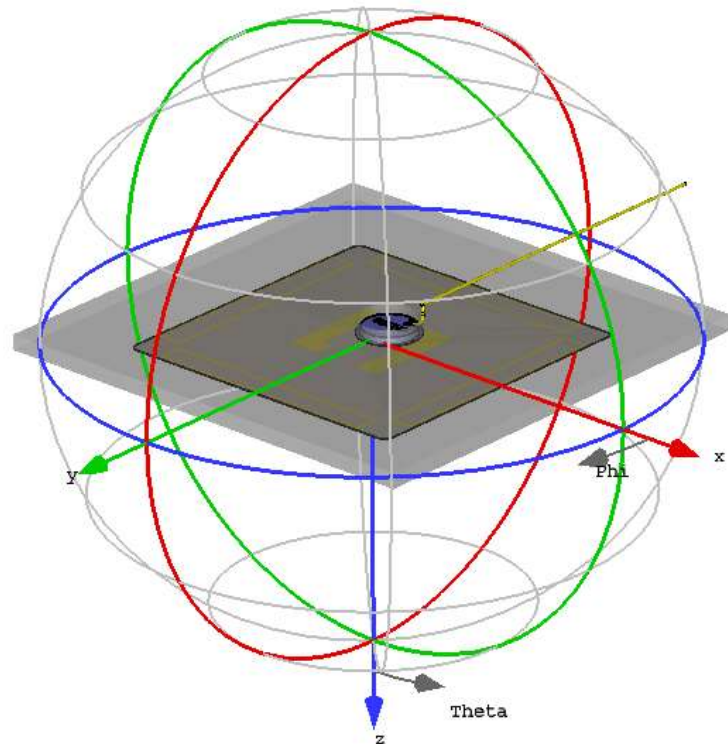

Issue: 1713

In the effort to improve our products, we reserve the right to make changes judged to be necessary.

CONFIDENTIAL AND PROPRIETARY INFORMATION

This document contains confidential and proprietary information of Pulse Electronics, Inc. (Pulse) and is protected by copyright, trade secret and other state and federal laws. Its receipt or possession does not convey any rights to reproduce, disclose its contents, or to manufacture, use or sell anything it may describe. Reproduction, disclosure or use without specific written authorization of Pulse is strictly forbidden.

Description: In Building Public Safety
Antenna 450-490 MHz

Series: V-Thinity

PART NUMBER: PSIBUHF

CHARTS

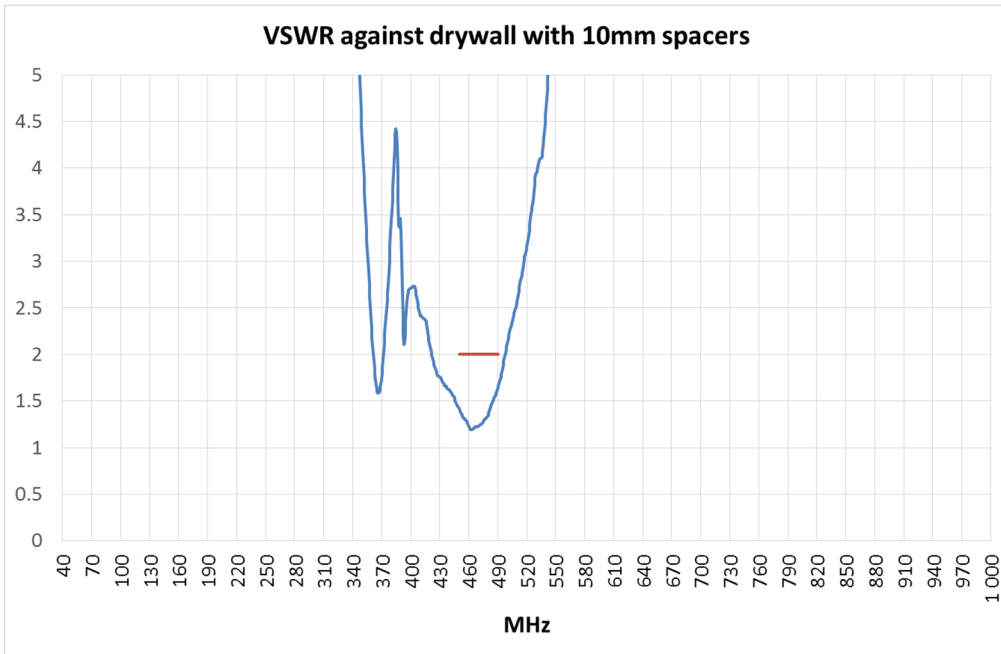
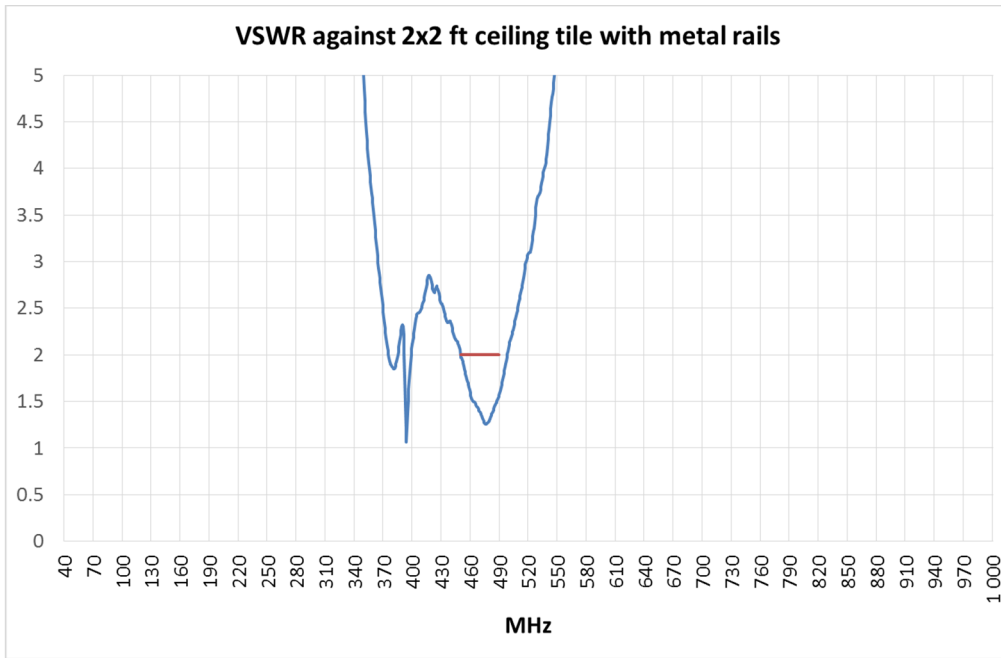

Issue: 1713

In the effort to improve our products, we reserve the right to make changes judged to be necessary.

CONFIDENTIAL AND PROPRIETARY INFORMATION

This document contains confidential and proprietary information of Pulse Electronics, Inc. (Pulse) and is protected by copyright, trade secret and other state and federal laws. Its receipt or possession does not convey any rights to reproduce, disclose its contents, or to manufacture, use or sell anything it may describe. Reproduction, disclosure or use without specific written authorization of Pulse is strictly forbidden.

Description: In Building Public Safety
Antenna 450-490 MHz

Series: V-Thinity

PART NUMBER: PSIBUHF

CHARTS

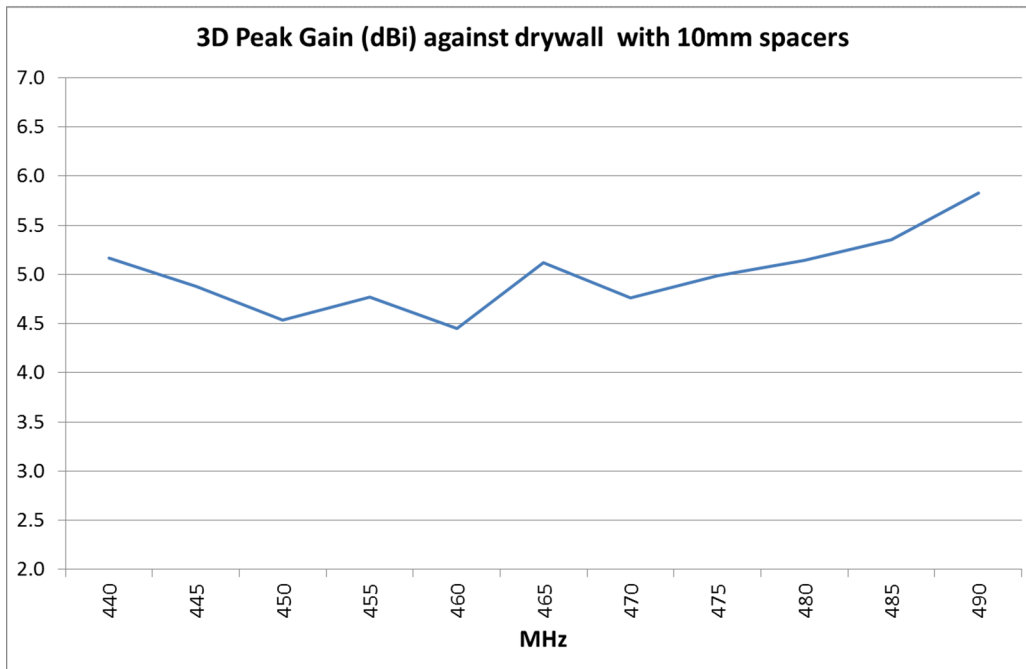
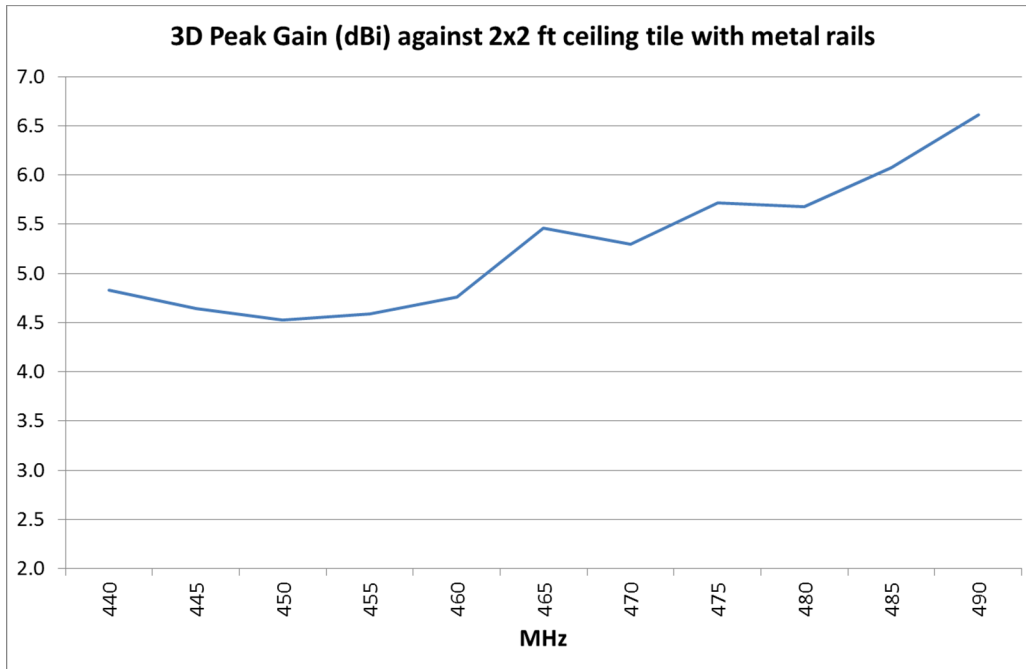

Issue: 1713

In the effort to improve our products, we reserve the right to make changes judged to be necessary.

CONFIDENTIAL AND PROPRIETARY INFORMATION

This document contains confidential and proprietary information of Pulse Electronics, Inc. (Pulse) and is protected by copyright, trade secret and other state and federal laws. Its receipt or possession does not convey any rights to reproduce, disclose its contents, or to manufacture, use or sell anything it may describe. Reproduction, disclosure or use without specific written authorization of Pulse is strictly forbidden.



CHARTS

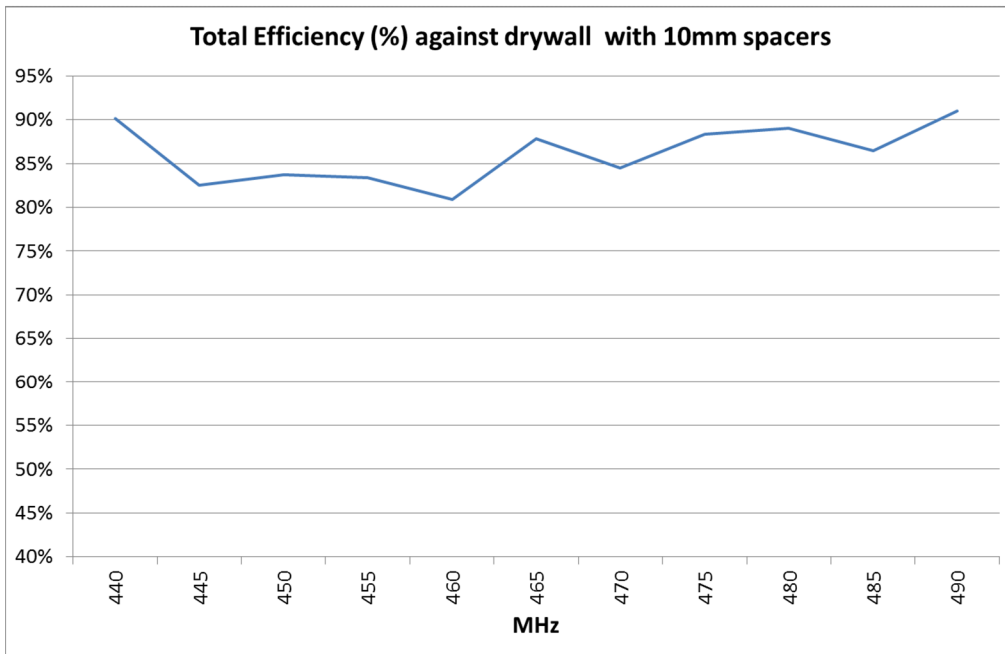
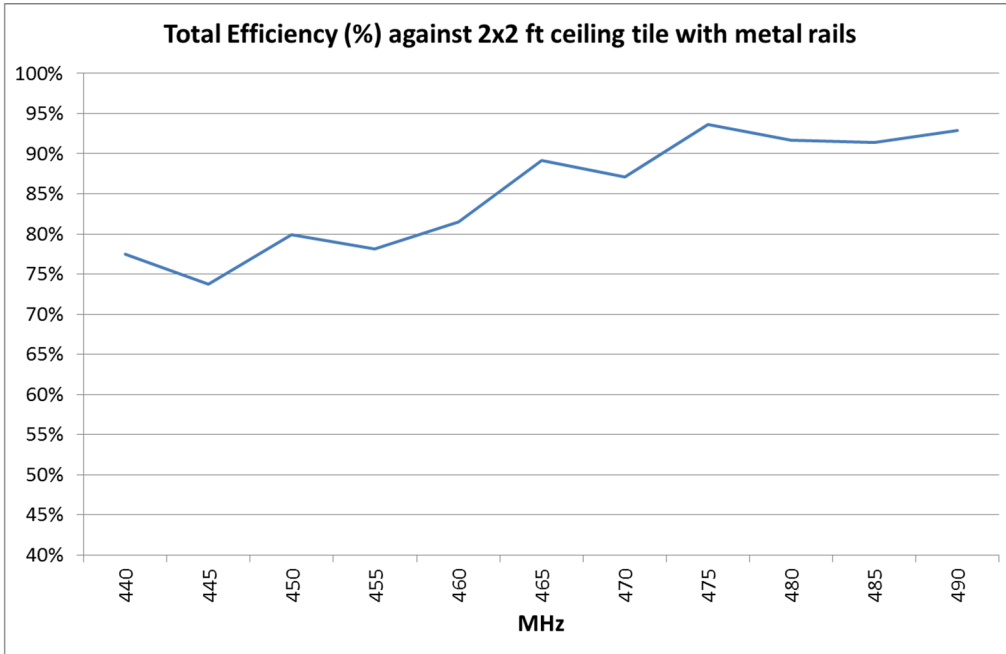

Issue: 1713

In the effort to improve our products, we reserve the right to make changes judged to be necessary.

CONFIDENTIAL AND PROPRIETARY INFORMATION

This document contains confidential and proprietary information of Pulse Electronics, Inc. (Pulse) and is protected by copyright, trade secret and other state and federal laws. Its receipt or possession does not convey any rights to reproduce, disclose its contents, or to manufacture, use or sell anything it may describe. Reproduction, disclosure or use without specific written authorization of Pulse is strictly forbidden.

CHARTS

Horizontal cut

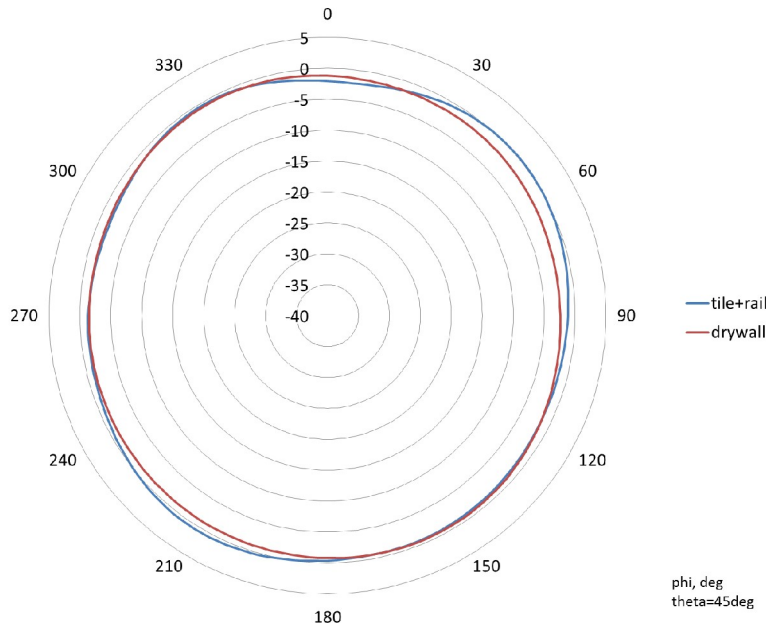

Vertical cut, Phi=90deg

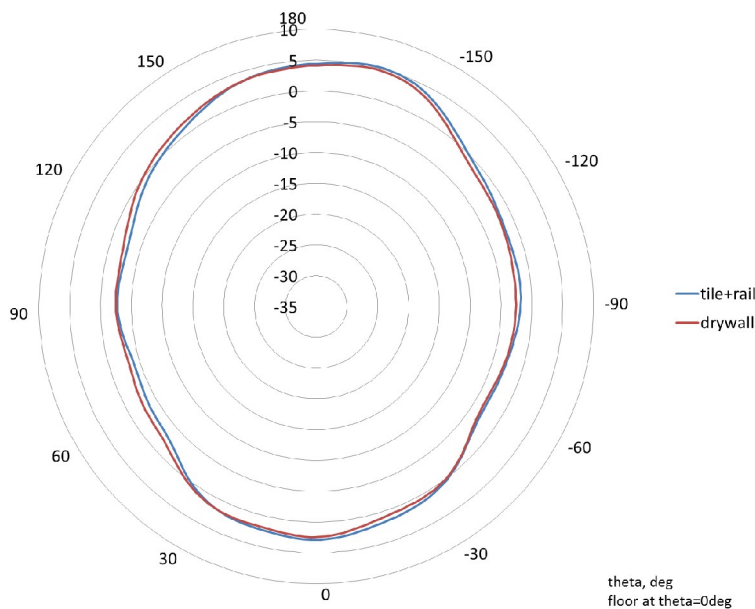

Issue: 1713

In the effort to improve our products, we reserve the right to make changes judged to be necessary.

CONFIDENTIAL AND PROPRIETARY INFORMATION

This document contains confidential and proprietary information of Pulse Electronics, Inc. (Pulse) and is protected by copyright, trade secret and other state and federal laws. Its receipt or possession does not convey any rights to reproduce, disclose its contents, or to manufacture, use or sell anything it may describe. Reproduction, disclosure or use without specific written authorization of Pulse is strictly forbidden.

Description: In Building Public Safety
Antenna 450-490 MHz

Series: V-Thinity

PART NUMBER: PSIBUHF

CHARTS

Vertical cut, Phi=0deg

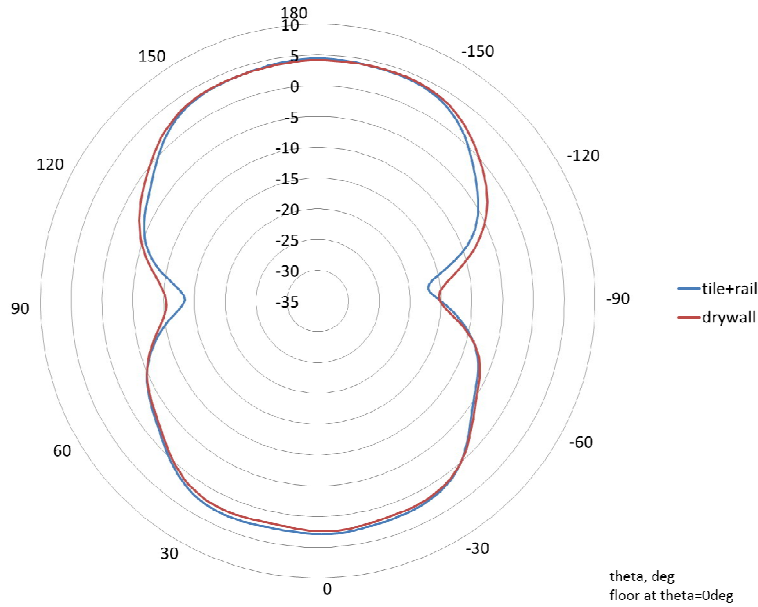

Issue: 1713

In the effort to improve our products, we reserve the right to make changes judged to be necessary.

CONFIDENTIAL AND PROPRIETARY INFORMATION

This document contains confidential and proprietary information of Pulse Electronics, Inc. (Pulse) and is protected by copyright, trade secret and other state and federal laws. Its receipt or possession does not convey any rights to reproduce, disclose its contents, or to manufacture, use or sell anything it may describe. Reproduction, disclosure or use without specific written authorization of Pulse is strictly forbidden.

Series: V-Thinity

Description: In Building Public Safety
Antenna 450-490 MHz

PART NUMBER: PSIBUHF

PACKAGING

- Each antenna packed in a plastic bag and a single box
- 1 label on each antenna with Part number, Description, Serial number, date code
- 34 single boxes of antennas (TBD) packed in a master carton.
- 1 label on each carton with Qty, Part number, Date code.

Description: In Building Public Safety
Antenna 450-490 MHz

Series: V-Thinity

PART NUMBER: PSIBUHF

Option - 1 Spacer Mount on Ceiling
(The Spacers are assemoved)

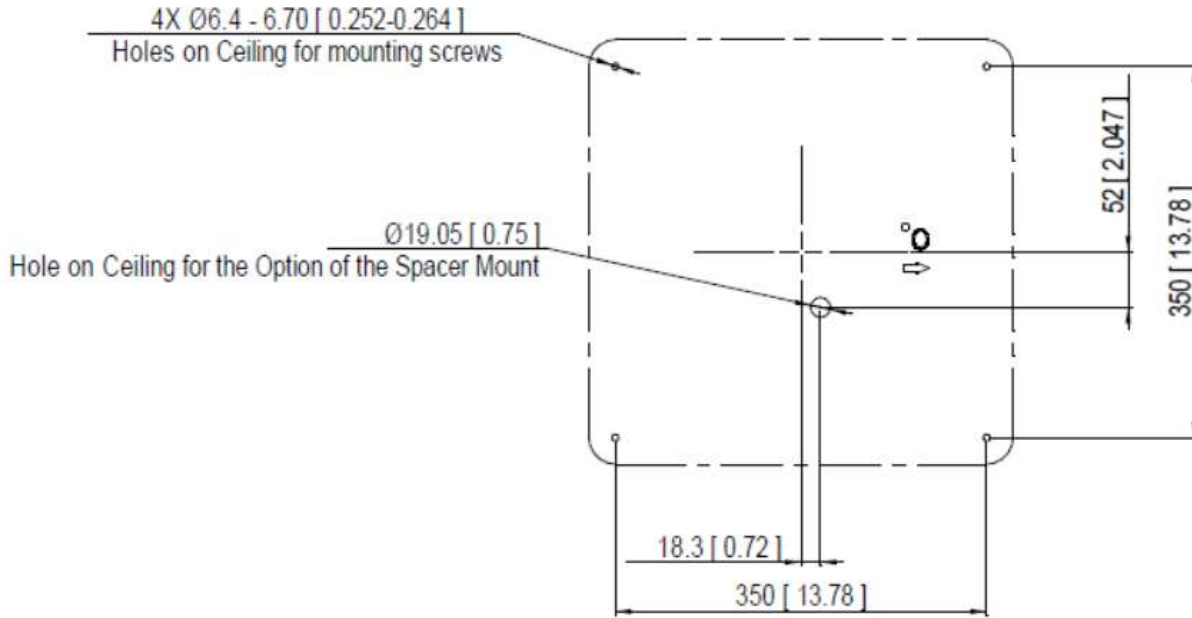

P.S.: View from the Downside of the Ceiling.

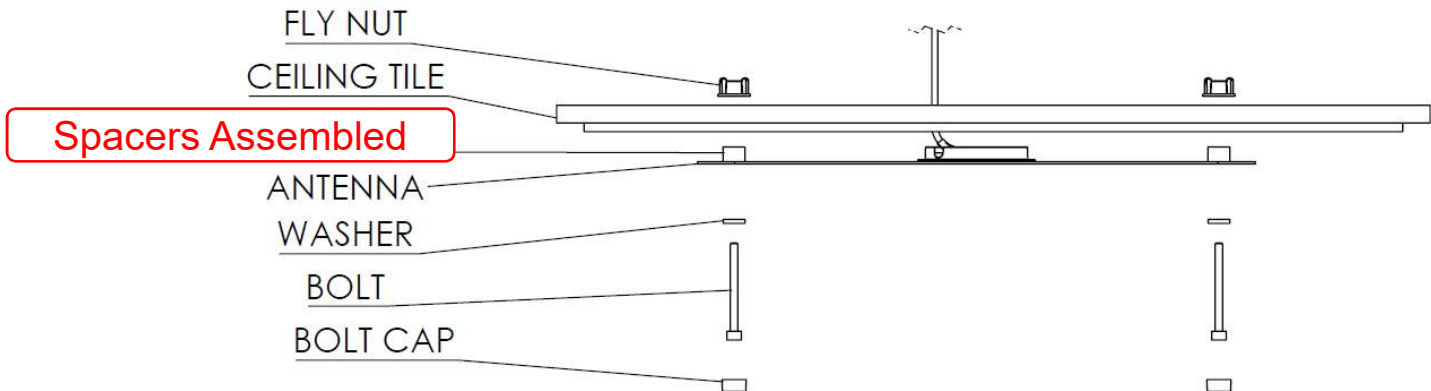

Issue: 1713

In the effort to improve our products, we reserve the right to make changes judged to be necessary.

CONFIDENTIAL AND PROPRIETARY INFORMATION

This document contains confidential and proprietary information of Pulse Electronics, Inc. (Pulse) and is protected by copyright, trade secret and other state and federal laws. Its receipt or possession does not convey any rights to reproduce, disclose its contents, or to manufacture, use or sell anything it may describe. Reproduction, disclosure or use without specific written authorization of Pulse is strictly forbidden.