

PST-360

Hall-Effect Through-Shaft Rotary Position Sensor

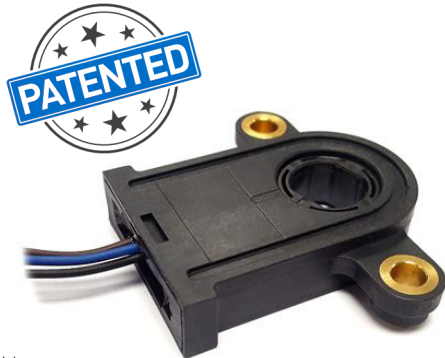

Available with

CAN

CE

KEY FEATURES



Non-contacting

True, contactless operation

Without any gears or mechanical interfaces the sensor is easily assembled and calibrated and subject to limited wear and tear over lifetime.

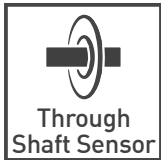

Through Shaft Sensor

Through-hole design

Allows shaft insertion from top or bottom, simple assembly and makes it even more suitable in applications where space is limited.

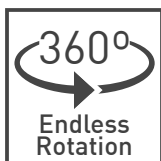

Endless Rotation

360 degree absolute position feedback

Endless mechanical rotational angle without dead band, keeps the position on power loss with programmable electrical angles from 15 to 360 degrees.



Made for harsh environments

The rugged package protects the sensor from dust, moisture, vibration and extreme temperatures for usage in the most demanding environments.



Long life

Durable and robust design

The non-contacting design allows for an extra-long product lifetime of up to 50 million cycles.



Fully customizable

Adaptable to your requirements

Programmable transfer function and switch outputs as well as different output protocols and redundancy levels available.

DESCRIPTION

The PST-360 position sensor combines a through-shaft design with accurate absolute position feedback and a true non-contacting sensing element that does not rely on gears or other rotating parts.

This innovative and unique patented design complements the attributes of the target application and maintains the mechanical integrity of the application by design. As the sensor is mounted directly at the pivot point no levers, connecting rods or other mechanical interfaces are needed.

Furthermore it adapts to shaft's eccentricity, mounting tolerances and mechanical wear over the life of the application.

The endless rotation sensor is highly configurable with a programmable angular range between 15 and 360 degrees, different signal output options and support for low and high-voltage power supply. Multi-turn configurations are available on request.

APPLICATIONS

Industrial

- ▶ Autonomous warehouse robotics
- ▶ Robotics and automation feedback
- ▶ Robot arm position
- ▶ Valve monitoring
- ▶ Conveyor operation

Transportation

- ▶ Steering angle
- ▶ Pedal position
- ▶ Fork height and mast tilt
- ▶ Bucket position
- ▶ Hitch position
- ▶ Boom angle
- ▶ Joystick controls

Marine

- ▶ Steering and shifter sensor
- ▶ Engine throttle

Home and Building Automation

- ▶ HVAC systems

Medical

- ▶ Electric hospital bed
- ▶ Mobility chair steering and throttle

PST-360

Hall-Effect Through-Shaft Rotary Position Sensor

MECHANICAL SPECIFICATIONS

Rotational life	Up to 50.000.000 cycles
Mechanical angular range	360° (endless rotation)
Rotor diameter ¹	14mm 17mm

¹ Other rotors on request

ELECTRICAL SPECIFICATIONS

Linearity ¹	Analog, PWM, SPI CAN	±1% absolute (±0.5% upon request) ±1,5% absolute
Electrical angular range ²		Programmable from 15° to 360°
Output		Analog (ratiometric), PWM Serial Protocol (SPI) CAN SAE J1939 CAN Open
Switch output		Programmable upon request
Resolution	Analog, CAN, PWM SPI	Up to 12 bit Up to 14 bit
Supply voltage ³		5V ±10% 7V to 15V
Supply current	Single version Redundant version CAN version	Typ 8.5 mA Typ 17 mA Typ 47 mA
Voltage protection		±10 V
Self-diagnostic features		Yes

¹ Ferromagnetic materials close to the sensor (i.e. shaft, mounting surface) may affect the sensor's linearity.

² For information on multi-turn sensors please contact Piher

³ Voltages up to 25 V possible on request.

ENVIRONMENTAL SPECIFICATIONS

Operating and storage temperature ¹	-40°C to +125°C
Shock	50g
Vibration	5-2000 Hz; 20g; Amax 0,75 mm
Sealing ²	IP67, IP69K
Approval	CE ³

¹ Other specifications available

² IP rating on electronics

³ EMC-testing according to standards EN 61000-6-2 and EN 6100-6-3. CE-approval applies to analogic-simple and analogic-redundant models.

OUTPUT FUNCTIONS

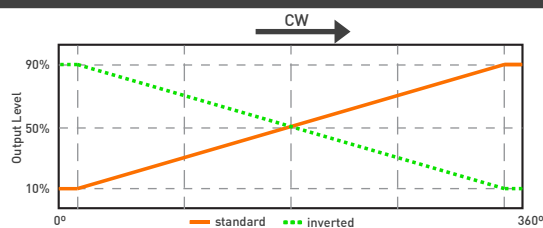

ERA			
270	→ 45°	180°	315°
180	→ 90°	180°	270°
120	→ 120°	180°	240°
090	→ 135°	180°	225°
040	→ 160°	180°	200°

ERA	Standard	Inverted	Redundant & Full Redundant
360°	C0000	C0001	C0002
270°	C0208	C0158	C0031
180°	C0007	C0072	C0036
120°	C0024	C0234	C0032
90°	C0011	CXXXX	C0025
70°	C0150	CXXXX	C0149
60°	C0006	C0260	C0020
40°	C0026	CXXXX	C0123

All output functions listed are centered in 180°. Output level from 10% to 90%

Linearity is assured within the electrical rotational angle (ERA) only. Other output functions available on request.

PST-360

Hall-Effect Through-Shaft Rotary Position Sensor

DIMENSIONS (MM)

Outer Dimensions

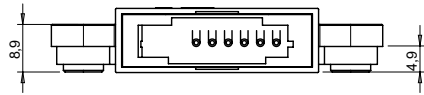

Download the STEP files at:
www.pihher.net

Shaft should be non-ferromagnetic material. If you want to use a ferromagnetic shaft please contact Piher.

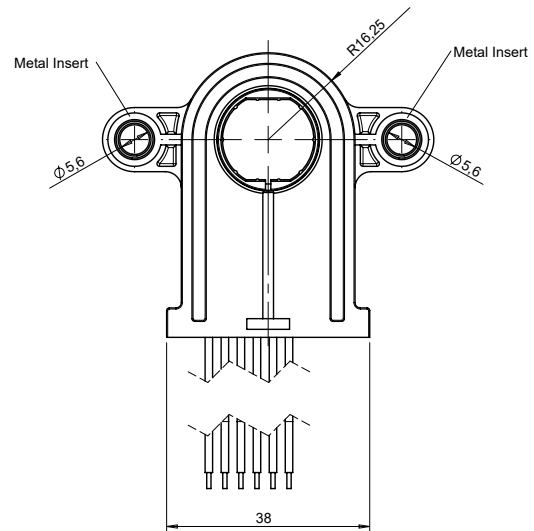
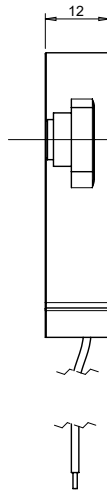
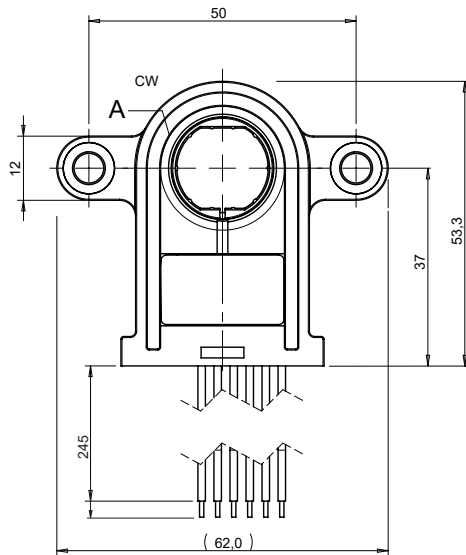

Sensor shown above is the 17mm version with the rotor at zero position. Sensor is delivered at random position. Wires: 0.35mm² TXL SAE J1128

14mm rotor

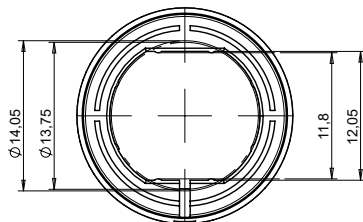

17mm rotor

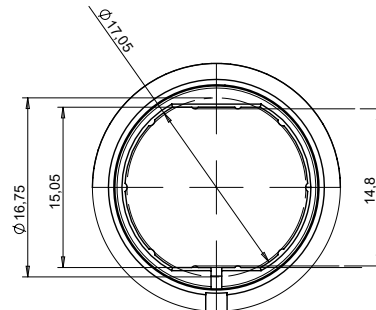

Recommended shaft dimensions

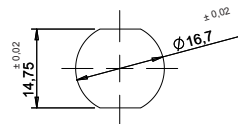
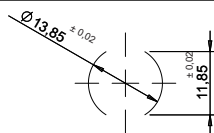

CONNECTION SCHEME

Color	Simple		Redundant		Full-redundant	CAN	SPI
	5V	7V to 15V	5V	7V to 15V			
Brown	Power supply	Power supply	Power supply	Power supply	Power supply 1	Power supply	Power supply
Blue	Ground	Ground	Ground	Ground	Ground 1	Ground	Ground
Black	Signal output	Signal output	Signal output 1	Signal output 1	Ground 2	CAN High	MOSI
White	n/a	n/a	Signal output 2	Signal output 2	Signal output 2	CAN Low	/SS
Red	n/a	n/a	n/a	n/a	Power supply 2	n/a	n/a
Yellow	n/a	n/a	n/a	n/a	Signal output 1	n/a	n/a
Grey	n/a	Not used	n/a	Not used	n/a	n/a	SCLK

More instructions of use on www.pihher.net. Connector assembly available on request.

PST-360

Hall-Effect Through-Shaft Rotary Position Sensor

HOW TO ORDER (Example: PST360G2-1A-C0001-ERA190-05K)

Simple Output - Analogic, PWM and CAN

PST360G2	-	-	1	-	C_____	-	ERA_____	-	___	K	-	_____
Series	Rotor ¹	Type	Output ²	Output function ³	Electric rotational angle ⁴	Voltage supply ⁵	Temp. range	PWM Frequency Hz ⁶				
	[empty] = 14mm B = 17mm	1 = simple	A = analogic P = PWM J = CAN SAE J1939 O = CAN OPEN	C0000 C0001	ERA040 ERA041 ... ERA360	05 = 5V ±10% RE = 7V-15V	K = -40°C to +125°C	[empty] = 200Hz F100 = 100Hz F101 = 101Hz ... F999 = 999Hz				

Simple output - SPI

PST360G2	-	-	1	S	-	C_____	-	ERA_____	-	___	K
Series	Rotor ¹	Type	Output ²	Output function ³	Electric rotational angle ⁴	Voltage supply ⁵	Temp. range				
	[empty] = 14mm B = 17mm	1 = simple	S = SPI	C0000 C0001	ERA040 ERA041 ... ERA360	05 = 5V ±10% RE = 7V-15V	K = -40°C to +125°C				

Redundant output - Analogic, PWM and CAN

PST360G2	-	-	2	___	-	C_____	-	ERA_____	-	___	K	-	_____	_____
Series	Rotor ¹	Type	Output ²	Output function ³	Electric rotational angle ⁴	Voltage supply ⁵	Temp. range	PWM Frequency Hz. (1) ⁶	PWM Frequency Hz. (2) ⁶					
	[empty] = 14mm B = 17mm	2 = redundant	AA= analogic PP = PWM JJ = CAN SAE J1939 OO = CAN OPEN	C0002	ERA040 ERA041 ... ERA360	05 = 5V ±10% RE = 7V-15V	K = -40°C to +125°C	F100 F101 ... F999	F100 F101 ... F999					

Full-redundant output - Analogic and PWM

PST360G2	-	-	3	___	-	C_____	-	ERA_____	-	05	K	-	_____	_____
Series	Rotor ¹	Type	Output ²	Output function ³	Electric rotational angle ⁴	Voltage supply	Temp. range	PWM Frequency Hz. (1) ⁵	PWM Frequency Hz. (2) ⁵					
	[empty] = 14mm B = 17mm	3 = full-redundant	AA= analogic PP = PWM	C0002	ERA040 ERA041 ... ERA360	05 = 5V ±10%	K = -40°C to +125°C	F100 F101 ... F999	F100 F101 ... F999					

1 Other rotors available on request.

2 The analog output is ratiometric, proportional: - for supply voltage "5V" to input voltage; -for supply voltage "RE" to 5V.

3 Other output functions available, please check availability. Enter CXXXX as long as the new output function is not defined.

4 Models with ERA < 40° available on request

5 Voltages up to 25V possible on request.

6 Leave empty if not applicable. Default frequency is 200 Hz