

# PT-10 / PTC-10

## 10-mm carbon / cermet through-hole potentiometer

The PT-10 and PTC-10 potentiometers offer control where frequent adjustment is required. The shaftless design allows for employment of different engagement mechanisms, such as a customized shaft, a motor control or a human interface adjustment. This potentiometer can also control variable outputs including frequency, change in motor speed or volume.

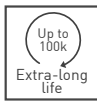

### KEY FEATURES

- ▶ Excellent performance (up to 3% linearity)
- ▶ Carbon or cermet resistive element
- ▶ Up to 16 mechanical detents for tactile feedback
- ▶ Up to 100.000 life cycles
- ▶ IP54 protection
- ▶ Magazine packaging for automatic insertion available
- ▶ Polyester / Alumina substrate
- ▶ Wiper positioned at initial, 50% or fully clockwise
- ▶ Loose and assembled shaft and knobs
- ▶ Linear, logarithmic and antilogarithmic tapers
- ▶ Self extinguishable plastic (UL 94V-0) available
- ▶ SPDT switch and low torque version available

### On request

- ▶ Embossed tape packaging

### ELECTRICAL SPECIFICATIONS

	PT-10	PTC-10
Taper <sup>1</sup>	Lin, Log, Alog	
Range of values <sup>1</sup>	(Decad. 1.0 - 2.0 - 2.2 - 2.5 - 4.7 - 5.0)	
Lin	100Ω ≤ Rn ≤ 5MΩ	
Log, Alog	1KΩ ≤ Rn ≤ 5MΩ	
Tolerance <sup>1</sup>		
100Ω ≤ Rn ≤ 1MΩ	± 20%	
1MΩ < Rn ≤ 5MΩ	± 30%	
Max. Voltage		
Lin	200 VDC	
Log, Alog	100 VDC	
Nominal power	50°C (122°F)	70°C (158°F)
Lin	0.15 W	0.33 W
Log, Alog	0.07 W	0.17 W
Residual resistance <sup>1</sup>	≤ 0.5% Rn (5Ω min.)	
Equivalent noise resistance	≤ 3% Rn (3Ω min.)	
Operating temperature	-25°C to +70°C <sup>2</sup> [-13°F to + 158°F]	-40°C to +90°C <sup>3</sup> [-40°F to + 194°F]

<sup>1</sup> Others available on request; <sup>2</sup> Up to 85°C depending on application.; <sup>3</sup> +120°C/+248°F upon request

### APPLICATIONS

- ▶ Appliance program selection
- ▶ Thermostat adjustment
- ▶ Timer and control relays
- ▶ Consumer electronics
- ▶ Power tool controls
- ▶ Test and measurement equipment

# PT-10 / PTC-10

## 10-mm carbon / cermet through-hole potentiometer

### MECHANICAL SPECIFICATIONS

	PT-10	PTC-10
Mechanical rotation angle <sup>1</sup>	235° ± 5°	
Electrical rotation angle <sup>1</sup>	220° ± 20°	
Torque Rotational Stop	0.4 to 2 Ncm (0.6 to 2.7 in-oz) > 5 Ncm (>7 in-oz)	
Push-pull force over the rotor	> 49N	
Life <sup>2</sup>	Up to 100k cycles	Up to 10k cycles

<sup>1</sup> Endless rotation available: ST-10; <sup>2</sup> Others check availability

### ENVIRONMENTAL TESTING

	Test method (CEI 393-1)	PT-10 ΔR(%) - Piher typical test results	PTC-10 ΔR(%) - Piher typical test results
Electrical life	1.000h at 50°C; 0.15W 1.000h at 70°C; 0.33W	±5% n/a	n/a ±2%
Mechanical life	1000 cycles at 10 to 15 cpm	±3 % (Rn < 1M )	±2%
Temperature coefficient	-25°C; +70°C -40°C; +90°C	±300 ppm/°C (Rn < 100K) n/a	n/a ±100 ppm/°C
Thermal cycling	16h at 85°C and 2h at -25°C 16h at 90°C and 2h at -40°C	±2.5% n/a	n/a ±2%
Damp heat	500h at 40°C and 95% relative humidity (RH)	±5%	±2%
Vibration	2h each plane at 10Hz - 55Hz	±2%	±2%
Storage	6 month at 23°C ±2°C and 50% RH	±2.5%	±2%

Out of range values may not comply with these results. Standard test conditions: temperature: 23°C ±2°C and 45% to 70% RH

### RECOMMENDED CONNECTIONS

Recommended connection circuit for a position sensor or control application (voltage divider circuit electronic design).

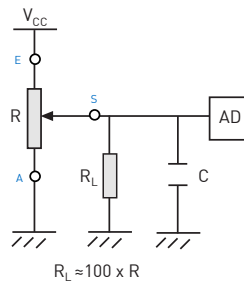

### POWER RATING CURVE

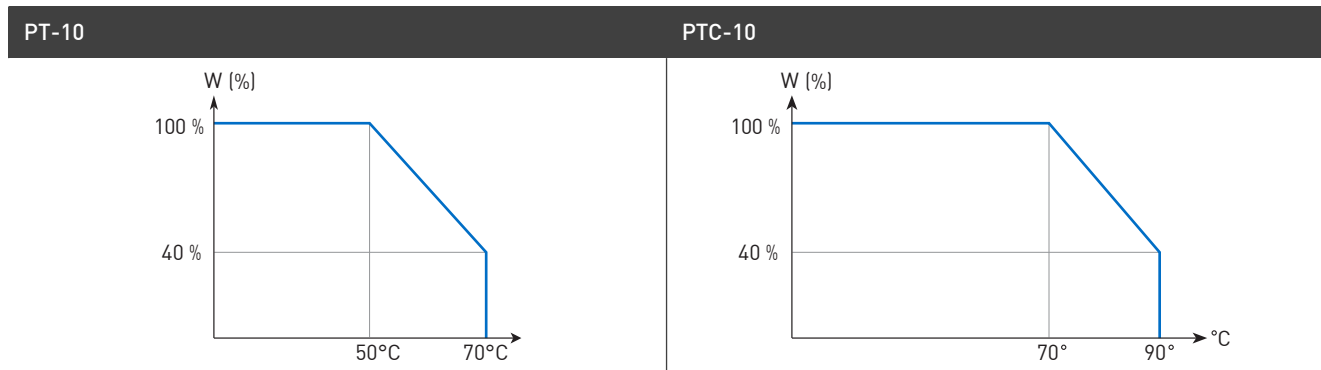

# PT-10 / PTC-10

## 10-mm carbon / cermet through-hole potentiometer

### HOW TO ORDER

Carbon potentiometer (Example: PT10LH01-101A2020-S)

PT10	---	---	---	---	---	Optional features						S	
<b>Series</b>	<b>Rotors<sup>1</sup></b>	<b>Mounting method<sup>2</sup></b>	<b>Ω-Value<sup>3</sup></b>	<b>Taper</b>	<b>Tolerance<sup>4</sup></b>	<b>Life</b>	<b>Cut track</b>	<b>Detents</b>	<b>Shaft/Knob</b>	<b>Flammability<sup>6</sup></b>	<b>Shaft/Rotor color<sup>7</sup></b>	<b>Torque</b>	<b>Wiper position</b>
B G K L M R W X Y Z	H01 horizontal adjust H04 H05 H07 H02 crimped terminals H10 V05 vertical adjust V10 V11 crimped terminals V13	101 = 100Ω 201 = 200Ω ... 504 = 500KΩ 505 = 5MΩ 000 = CM	A = lin. B = log. C = alog.	0505 = ±5% 0707 = ±7% 1010 = ±10% 2020 = ±20% 3030 = ±30% XXYY = ±XX-YY%	[empty] = 1K cycles E = 10K cycles	[empty] PCI PCF	[empty] PAI PAM PAF P11 P1F P02 ... P16	[empty] = none 1 = Fig.1 2 = Fig.2 ... 18 = Fig.18	[empty] = standard I = non-flammable	[empty] AM = yellow AZ = blue BL = white CR = cream GR = grey MA = brown NA = orange NE = black RO = red VE = green VI = violet	[empty] = standard L = ≤ 1 Ncm	[empty] = initial PM = 50% PF = final	

Cermet potentiometer (Example: PTC10LH01-101A2020)

PTC10	---	---	---	---	---	Optional features							
<b>Series</b>	<b>Rotors<sup>1</sup></b>	<b>Mounting method<sup>2</sup></b>	<b>Ω-Value<sup>3</sup></b>	<b>Taper</b>	<b>Tolerance<sup>4</sup></b>	<b>Life</b>	<b>Detents</b>	<b>Packaging<sup>5</sup></b>	<b>Shaft/Knob</b>	<b>Flammability<sup>6</sup></b>	<b>Shaft/Rotor color<sup>7</sup></b>	<b>Torque</b>	<b>Wiper position</b>
B G K L M R W X Y Z	H01 horizontal adjust H04 H05 H07 H02 crimped terminals H10 V05 vertical adjust V10 V11 crimped terminals V13	101 = 100Ω 201 = 200Ω ... 504 = 500KΩ 505 = 5MΩ 000 = CM	A = lin. B = log. C = alog.	0505 = ±5% 0707 = ±7% 1010 = ±10% 2020 = ±20% 3030 = ±30% XXYY = ±XX-YY%	[empty] = 1K cycles E = 10K cycles	[empty] PAI PAM PAF P11 P1F P02 ... P16	[empty] = bulk T = magazines	[empty] = none 1 = Fig.1 2 = Fig.2 ... 18 = Fig.18	[empty] = standard I = non-flammable	[empty] AM = yellow AZ = blue BL = white CR = cream GR = grey MA = brown NA = orange NE = black RO = red VE = green VI = violet	[empty] = standard L = ≤ 1 Ncm	[empty] = initial PM = 50% PF = final	

1. Rotors: "Z" adjustment only available on "H"-mounting versions. Rotor "G" only available in purple (shaft/rotor color "VI")

2. Mounting method: "V05", "H07" terminals material: brass.

3. Ω- Value: XXX - First two digits of Ω-value      000 = CM = switch SPDT version  
XXX - Number of zeros

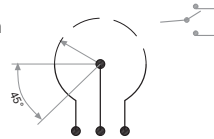

4. Tolerance: for custom tolerance please check availability: info@piher.net

5. Packaging: available options depend on mounting method, see "available packaging option" below. Embossed tape packaging on request.

6. Non-flammable according to UL 94V-0: housing, rotor and shaft. PTC-10 made of non-flammable material by standard.

7. Without knob or shaft: only the rotor. With knob or shaft: only the knob/shaft.

### ORDER CODE EXAMPLES

PT10LH01-103A2020-S

10mm carbon potentiometer with rotor "L" (arrow shape), H01 mounting method (horizontal adjustment), 10K value, linear taper and 20% resistive tolerance.

PTC10WV05-104A1010-9-NE

10mm cermet potentiometer with rotor "W" (pre-inserted shaft), V05 mounting method (vertical adjustment), 100K resistive value, linear taper, 10% resistive tolerance and black shaft.

# PT-10 / PTC-10

## 10-mm carbon / cermet through-hole potentiometer

### STANDARD CONFIGURATION

	PT-10	PTC-10
Life	1.000 cycles	
Cut track	no	n/a
Detents	none	
Packaging	bulk	
Shaft/thumb wheel	none	
Non-flammability	no	yes
Housing color	black	cream
Rotor color	white	cream
Wiper Position	initial	
Torque	0.4 to 2 Ncm	
Linearity	not controlled	

### ROTORS

#### Without shaft or knob

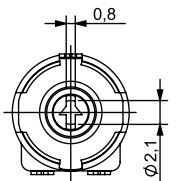
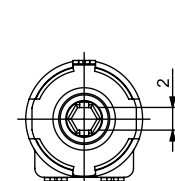
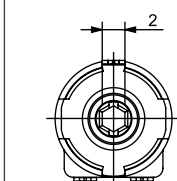
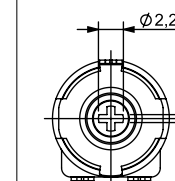
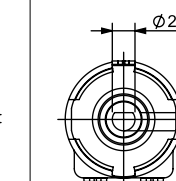
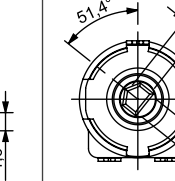
L Screwdriver	M Hexagonal	G Hexagonal	K Cross slot	R	B
					

#### With inserted shaft

#### With inserted knob / thumbwheel

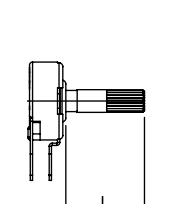
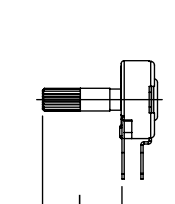
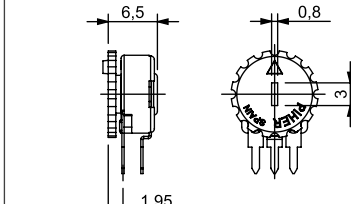
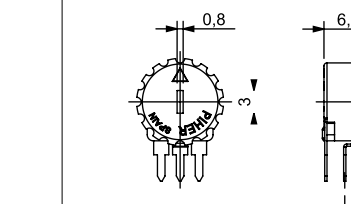
X Adjustable from collector side	W Adjustable from terminal side	Y Adjustable from terminal side Default knob is Fig. 5 - Ref. 5034	Z Adjustable from collector side Default knob is Fig. 5 - Ref. 5034
			

Default delivery is at initial position. Wipers are shown positioned at 50% for the picture.



Download the STEP file here:  
[www.pihher.net](http://www.pihher.net)

# PT-10 / PTC-10

## 10-mm carbon / cermet through-hole potentiometer

### MOUNTING METHOD

#### Vertical adjust / Horizontal mounting - straight terminals

V05 - 5mm

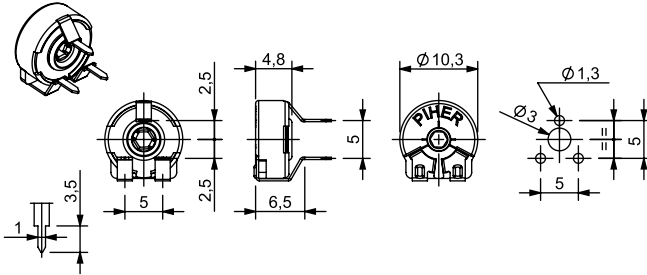

V10 - 10mm

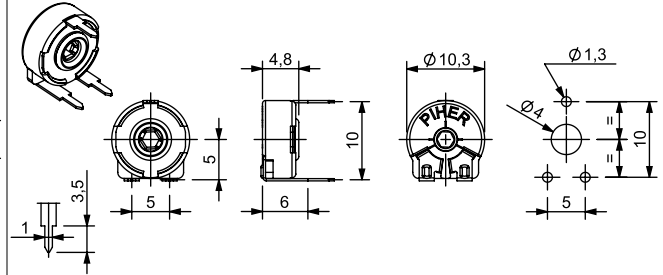

#### Vertical adjust / Horizontal mounting - crimped terminals

V11 - 10mm

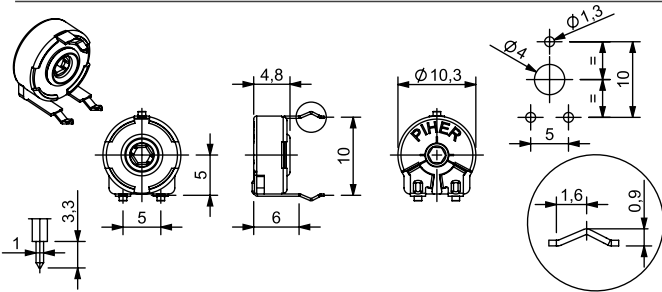

V13 - 10mm

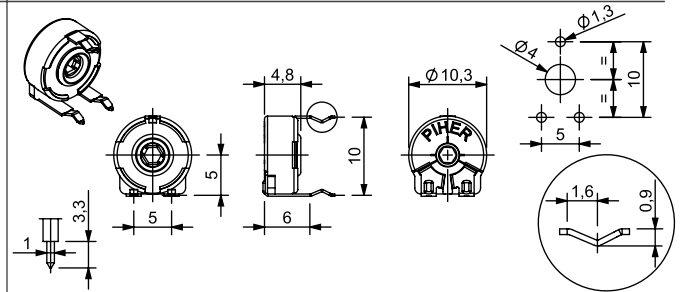

#### Horizontal adjust / Vertical mounting - straight terminals

H01 - 2.5mm

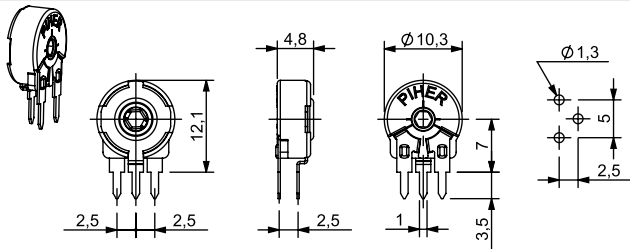

H04 - 3.8mm

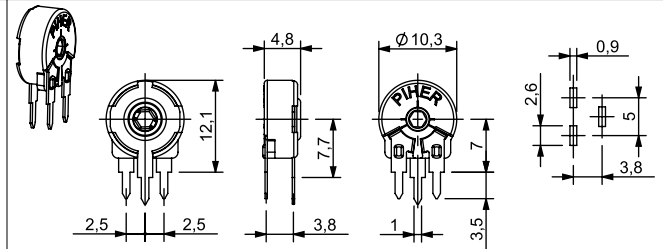

H05 - 5mm

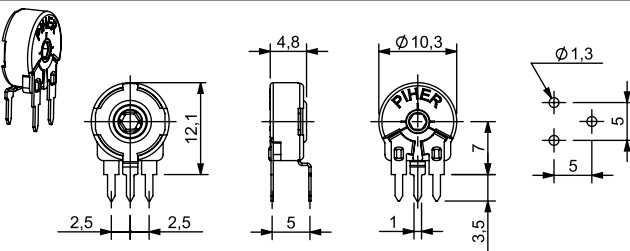

H07 - 3.8mm (only PT-10)

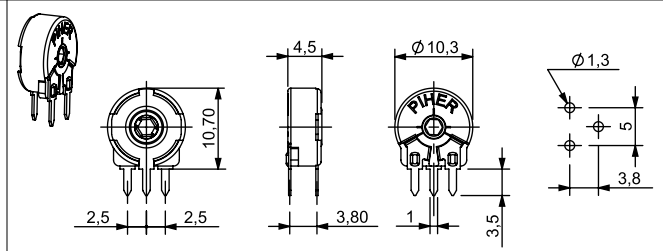

#### Horizontal adjust / Vertical mounting - crimped terminals

H02 - 2.5mm

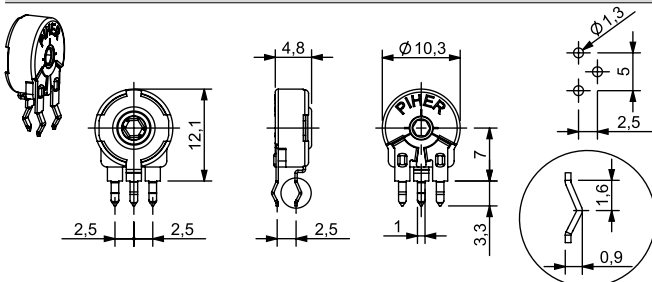

H10 - 5mm

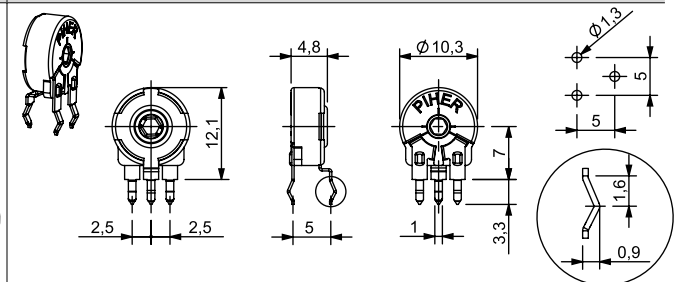

# PT-10 / PTC-10

## 10-mm carbon / cermet through-hole potentiometer

### STANDARD RESISTANCE-VALUES AND TOLERANCES

Resistance $\Omega$	100	200	220	250	470	500	1K	2K	2.2K	2.5K	4.7K	5K	10K	20K	22K	25K	47K	50K	100K	200K	220K	250K	470K	500K	1M	2M	2.5M	4.7M	5M
Order Code	101	201	221	251	471	501	102	202	222	252	472	502	103	203	223	253	473	503	104	204	224	254	474	504	105	205	255	475	505
Tolerance	20%																								30%				

### SWITCH VERSIONS AVAILABLE WITH OR WITHOUT DETENTS

A80 Switch code

Switch standard specification

A80 Switch code

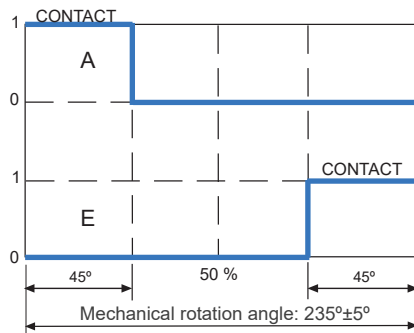

Power rating: 24V / 15mA  
 ON position resistance:  $\leq 5\Omega$   
 Insulation resistance:  $\geq 30M\Omega$

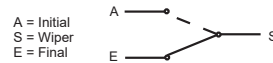

Contact Piher Sensing Systems for ordering information.

### TAPERS

Standard

Example: special custom taper

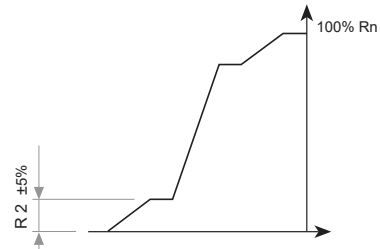
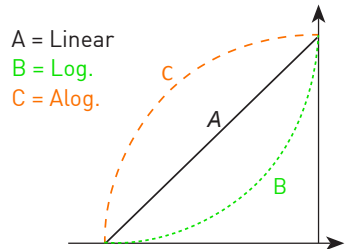

For more information on custom tapers contact Piher Sensing Systems.

### CUT TRACKS (OPEN CIRCUIT DESIGN)

PCI

PCF

CCW on-off (A)

Cut track at the beginning of travel.

Cut track at the end of travel.

CW on-off (E)

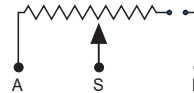
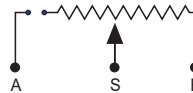

Other configurations available upon request. Cut Track not available for PTC-10.

# PT-10 / PTC-10

## 10-mm carbon / cermet through-hole potentiometer

### DETENTS

PAM	P1i	P1F	P02	P03	P04	P05	P06
P07	P08	P09	P10	P11	P12	P13	P16
PAI		PID		PFD		PAF	
<p>(wiper positioned at initial)</p>		<p>A = 26° B = 27.5°</p>				<p>(wiper positioned at final)</p>	

— Relative detent positions along total mechanical travel

Standard mechanical life is 500 cycles.  
 Long life versions are available upon request and have the following characteristics at T<sup>a</sup>: Potentiometers with 1 to 3 detents up to 10K cycles; Potentiometers with 4 and more detents up to 5K cycles.  
 Please consult Piher Sensing Systems if unique non-overlapping values at each detent position or LOG/ALOG tapers are required.  
 Different output voltage values can be matched at each detent position (see next section).  
 Detent torque can vary from 1.2 to 2.5 times the standard potentiometer torque.  
 For more than 16 detents versions please contact Piher Sensing Systems.

### STEPPED OUTPUTS / CONSTANT VALUE ZONES

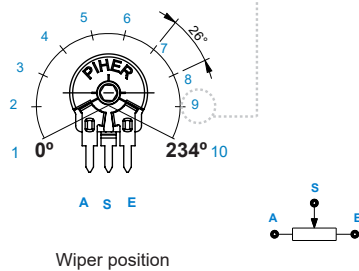
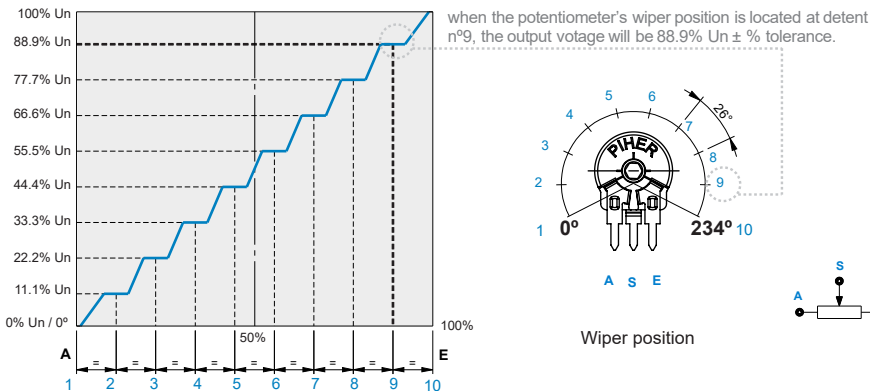

### IMPROVED REPEATABILITY

Constant value zones can be combined with strategically located mechanical detents to provide exact alignment between the electrical output (flat areas) and the mechanical detent position. This provides clear mechanical positions that are not only repeatable, but perfectly aligned electrical outputs at each of the (detent) angles. The detents also prevent output values from changing due to vibration or accidental rotor movements. The result is a higher level of precision in controlling lighting, temperature, motor or other electronic control systems.

Contact Piher Sensing Systems for ordering information.

# PT-10 / PTC-10

## 10-mm carbon / cermet through-hole potentiometer

### PACKAGING

Bulk



Dimensions (mm): 185x85x80

Without shaft: 1000 units per box  
 With Thumbweel: 800 units per box  
 With shaft: 400 units per box

### Magazine for automatic insertion (50 units)

Horizontal adjust

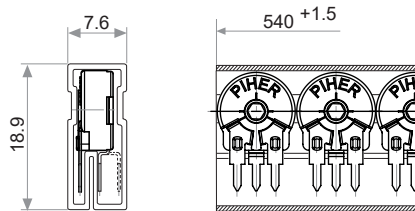

Vertical adjust

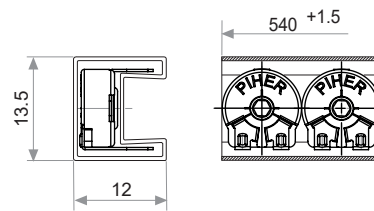

### AVAILABLE PACKAGING OPTIONS

Mounting Type	Terminal Style	Mounting Method	Bulk	Magazine
Horizontal adjust	Straight	H01	x	x
		H04	x	x
		H05	x	x
		H07	x	x
	Crimped	H02	x	x
		H10	x	
Vertical adjust	Straight	V05	x	
		V10	x	x
	Crimped	V11	x	x
		V13	x	

Rotor Type X, W, Y, Z only in bulk packaging. Embossed tape packaging on request.



# PT-10 / PTC-10

## 10-mm carbon / cermet through-hole potentiometer

SHAFTS, KNOBS AND THUMBWHEELS (TOP VIEW, FOR G AND M ROTOR TYPES)					
Fig. 1 - Ref. 5016 	Fig. 2 - Ref. 5053 	Fig. 3 - Ref. 5012 	Fig. 4 - Ref. 6053 	Fig. 5 - Ref. 5034 	Fig. 6 - Ref. 5035 
Fig. 7 - Ref. 5115 	Fig. 8 - Ref.: 5116 	Fig. 9 - Ref 5119 	Fig. 10 - Ref. 5120 	Fig. 12 - Ref. 6052 	Fig. 14 - Ref. 5055 
Fig. 15 - Ref. 6008 	Fig. 16 - Ref. 5039 	Fig. 17 - Ref. 5062 		Upon request: Numbered thumbwheel 	
Fig. 18 - Ref: 6064 2-gang plastic knob/shaft 				Shaft and knobs are delivered unassembled if not specified otherwise in part number code (W, X, Y, Z). The position of assembled knobs Fig 5, 15, 16 can be indicated in part number code: Initial (default), 50% (PM) or Final (PF), others will be delivered at random position by default. Custom specific positions are available for all shafts and knobs on request.  Non flammable plastic available, if potentiometer is orderer with non-flammable plastic (UL-94V0), the shaft or knob will be delivered with non-flammable plastic. If you wish to use your own plastic shaft/knob/actuator please contact Piher for advice about compatible materials.	